

# *Assembly Language*

FOR x86 PROCESSORS

*Seventh Edition*



*Kip Irvine*

## ASCII CONTROL CHARACTERS

The following list shows the ASCII codes generated when a control key combination is pressed. The mnemonics and descriptions refer to ASCII functions used for screen and printer formatting and data communications.

ASCII Code*	Ctrl-	Mnemonic	Description	ASCII Code*	Ctrl-	Mnemonic	Description
00		NUL	Null character	10	Ctrl-P	DLE	Data link escape
01	Ctrl-A	SOH	Start of header	11	Ctrl-Q	DC1	Device control 1
02	Ctrl-B	STX	Start of text	12	Ctrl-R	DC2	Device control 2
03	Ctrl-C	ETX	End of text	13	Ctrl-S	DC3	Device control 3
04	Ctrl-D	EOT	End of transmission	14	Ctrl-T	DC4	Device control 4
05	Ctrl-E	ENQ	Enquiry	15	Ctrl-U	NAK	Negative acknowledge
06	Ctrl-F	ACK	Acknowledge	16	Ctrl-V	SYN	Synchronous idle
07	Ctrl-G	BEL	Bell	17	Ctrl-W	ETB	End transmission block
08	Ctrl-H	BS	Backspace	18	Ctrl-X	CAN	Cancel
09	Ctrl-I	HT	Horizontal tab	19	Ctrl-Y	EM	End of medium
0A	Ctrl-J	LF	Line feed	1A	Ctrl-Z	SUB	Substitute
0B	Ctrl-K	VT	Vertical tab	1B	Ctrl-[	ESC	Escape
0C	Ctrl-L	FF	Form feed	1C	Ctrl-\	FS	File separator
0D	Ctrl-M	CR	Carriage return	1D	Ctrl-]	GS	Group separator
0E	Ctrl-N	SO	Shift out	1E	Ctrl-^	RS	Record separator
0F	Ctrl-O	SI	Shift in	1F	Ctrl-†	US	Unit separator

\* ASCII codes are in hexadecimal.

† ASCII code 1Fh is Ctrl-Hyphen (-).

## ALT-KEY COMBINATIONS

The following hexadecimal scan codes are produced by holding down the ALT key and pressing each character:

Key	Scan Code	Key	Scan Code	Key	Scan Code
1	78	A	1E	N	31
2	79	B	30	O	18
3	7A	C	2E	P	19
4	7B	D	20	Q	10
5	7C	E	12	R	13
6	7D	F	21	S	1F
7	7E	G	22	T	14
8	7F	H	23	U	16
9	80	I	17	V	2F
0	81	J	24	W	11
-	82	K	25	X	2D
=	83	L	26	Y	15
		M	32	Z	2C

## KEYBOARD SCAN CODES

The following keyboard scan codes may be retrieved either by calling INT 16h or by calling INT 21h for keyboard input a second time (the first keyboard read returns 0). All codes are in hexadecimal:

### FUNCTION KEYS

Key	Normal	With Shift	With Ctrl	With Alt
F1	3B	54	5E	68
F2	3C	55	5F	69
F3	3D	56	60	6A
F4	3E	57	61	6B
F5	3F	58	62	6C
F6	40	59	63	6D
F7	41	5A	64	6E
F8	42	5B	65	6F
F9	43	5C	66	70
F10	44	5D	67	71
F11	85	87	89	8B
F12	86	88	8A	8C

Key	Alone	With Ctrl Key
Home	47	77
End	4F	75
PgUp	49	84
PgDn	51	76
PrtSc	37	72
Left arrow	4B	73
Rt arrow	4D	74
Up arrow	48	8D
Dn arrow	50	91
Ins	52	92
Del	53	93
Back tab	0F	94
Gray +	4E	90
Gray -	4A	8E

# ASSEMBLY LANGUAGE FOR x86 PROCESSORS

---

**Seventh Edition**

**KIP R. IRVINE**

**Florida International University  
School of Computing and Information Sciences**

**PEARSON**

Boston Columbus Indianapolis New York San Francisco Upper Saddle River  
Amsterdam Cape Town Dubai London Madrid Milan Munich Paris Montreal Toronto  
Delhi Mexico City São Paulo Sydney Hong Kong Seoul Singapore Taipei Tokyo

Vice President and Editorial Director, ECS: *Marcia Horton*  
Executive Editor: *Tracy Johnson*  
Executive Marketing Manager: *Tim Galligan*  
Marketing Assistant: *Jon Bryant*  
Program Management Team Lead: *Scott Disanno*  
Program Manager: *Clare Romeo*  
Project Manager: *Greg Dulles*  
Senior Operations Specialist: *Nick Sklitits*  
Operations Specialist: *Linda Sager*  
Permissions Project Manager: *Karen Sanatar*  
Full-Service Project Management: *Pavithra Jayapaul, Jouve*  
Printer/Binder: *Courier/Westford*  
Typeface: *Times*

IA-32, Pentium, i486, Intel64, Celeron, and Intel 386 are trademarks of Intel Corporation. Athlon, Phenom, and Opteron are trademarks of Advanced Micro Devices. TASM and Turbo Debugger are trademarks of Borland International. Microsoft Assembler (MASM), Windows Vista, Windows 7, Windows NT, Windows Me, Windows 95, Windows 98, Windows 2000, Windows XP, MS-Windows, PowerPoint, Win32, DEBUG, WinDbg, MS-DOS, Visual Studio, Visual C++, and CodeView are registered trademarks of Microsoft Corporation. Autocad is a trademark of Autodesk. Java is a trademark of Sun Microsystems. PartitionMagic is a trademark of Symantec. All other trademarks or product names are the property of their respective owners.

---

**Copyright © 2015, 2011, 2007, 2003 by Pearson Education, Inc., Upper Saddle River, New Jersey 07458.** All rights reserved. Manufactured in the United States of America. This publication is protected by Copyright and permissions should be obtained from the publisher prior to any prohibited reproduction, storage in a retrieval system, or transmission in any form or by any means, electronic, mechanical, photocopying, recording, or likewise. To obtain permission(s) to use materials from this work, please submit a written request to Pearson Higher Education, Permissions Department, 1 Lake Street, Upper Saddle River, NJ 07458.

Previously published as *Assembly Language for Intel-Based Computers*.

The author and publisher of this book have used their best efforts in preparing this book. These efforts include the development, research, and testing of the theories and programs to determine their effectiveness. The author and publisher make no warranty of any kind, expressed or implied, with regard to these programs or the documentation contained in this book. The author and publisher shall not be liable in any event for incidental or consequential damages in connection with, or arising out of, the furnishing, performance, or use of these programs.

#### **Library of Congress Cataloging-in-Publication Data**

Irvine, Kip R., 1951-

Assembly language for x86 processors / Kip R. Irvine, Florida International University,  
School of Computing and Information Sciences. — Seventh Edition.

pages cm

ISBN-13: 978-0-13-376940-1

ISBN-10: 0-13-376940-2

1. IBM microcomputers—Programming. 2. X86 assembly language (Computer program language) I. Title.

QA76.8.I77 2014

005.265—dc23

2013046432

10 9 8 7 6 5 4 3 2 1

**PEARSON**

ISBN-13: 978-0-13-376940-1

ISBN-10: 0-13-376940-2

*To Jack and Candy Irvine*

*This page intentionally left blank*

# CONTENTS

---

## **Preface   xxiii**

## **1   Basic Concepts   1**

### **1.1   Welcome to Assembly Language   1**

- 1.1.1   Questions You Might Ask   3
- 1.1.2   Assembly Language Applications   6
- 1.1.3   Section Review   6

### **1.2   Virtual Machine Concept   7**

- 1.2.1   Section Review   9

### **1.3   Data Representation   9**

- 1.3.1   Binary Integers   10
- 1.3.2   Binary Addition   12
- 1.3.3   Integer Storage Sizes   13
- 1.3.4   Hexadecimal Integers   13
- 1.3.5   Hexadecimal Addition   15
- 1.3.6   Signed Binary Integers   16
- 1.3.7   Binary Subtraction   18
- 1.3.8   Character Storage   19
- 1.3.9   Section Review   21

### **1.4   Boolean Expressions   22**

- 1.4.1   Truth Tables for Boolean Functions   24
- 1.4.2   Section Review   26

### **1.5   Chapter Summary   26**

### **1.6   Key Terms   27**

### **1.7   Review Questions and Exercises   28**

- 1.7.1   Short Answer   28
- 1.7.2   Algorithm Workbench   30

## **2   x86 Processor Architecture   32**

### **2.1   General Concepts   33**

- 2.1.1   Basic Microcomputer Design   33
- 2.1.2   Instruction Execution Cycle   34



---

2.1.3	Reading from Memory	36
2.1.4	Loading and Executing a Program	36
2.1.5	Section Review	37
<b>2.2</b>	<b>32-Bit x86 Processors</b>	<b>37</b>
2.2.1	Modes of Operation	37
2.2.2	Basic Execution Environment	38
2.2.3	x86 Memory Management	41
2.2.4	Section Review	42
<b>2.3</b>	<b>64-Bit x86-64 Processors</b>	<b>42</b>
2.3.1	64-Bit Operation Modes	43
2.3.2	Basic 64-Bit Execution Environment	43
<b>2.4</b>	<b>Components of a Typical x86 Computer</b>	<b>44</b>
2.4.1	Motherboard	44
2.4.2	Memory	46
2.4.3	Section Review	46
<b>2.5</b>	<b>Input–Output System</b>	<b>47</b>
2.5.1	Levels of I/O Access	47
2.5.2	Section Review	49
<b>2.6</b>	<b>Chapter Summary</b>	<b>50</b>
<b>2.7</b>	<b>Key Terms</b>	<b>51</b>
<b>2.8</b>	<b>Review Questions</b>	<b>52</b>
<b>3</b>	<b>Assembly Language Fundamentals</b>	<b>53</b>
<b>3.1</b>	<b>Basic Language Elements</b>	<b>54</b>
3.1.1	First Assembly Language Program	54
3.1.2	Integer Literals	55
3.1.3	Constant Integer Expressions	56
3.1.4	Real Number Literals	57
3.1.5	Character Literals	57
3.1.6	String Literals	58
3.1.7	Reserved Words	58
3.1.8	Identifiers	58
3.1.9	Directives	59
3.1.10	Instructions	60
3.1.11	Section Review	63
<b>3.2</b>	<b>Example: Adding and Subtracting Integers</b>	<b>63</b>
3.2.1	The <i>AddTwo</i> Program	63
3.2.2	Running and Debugging the AddTwo Program	65
3.2.3	Program Template	70
3.2.4	Section Review	70

### **3.3 Assembling, Linking, and Running Programs 71**

- 3.3.1 The Assemble-Link-Execute Cycle 71
- 3.3.2 Listing File 71
- 3.3.3 Section Review 73

### **3.4 Defining Data 74**

- 3.4.1 Intrinsic Data Types 74
- 3.4.2 Data Definition Statement 74
- 3.4.3 Adding a Variable to the AddTwo Program 75
- 3.4.4 Defining BYTE and SBYTE Data 76
- 3.4.5 Defining WORD and SWORD Data 78
- 3.4.6 Defining DWORD and SDWORD Data 79
- 3.4.7 Defining QWORD Data 79
- 3.4.8 Defining Packed BCD (TBYTE) Data 80
- 3.4.9 Defining Floating-Point Types 81
- 3.4.10 A Program That Adds Variables 81
- 3.4.11 Little-Endian Order 82
- 3.4.12 Declaring Uninitialized Data 83
- 3.4.13 Section Review 83

### **3.5 Symbolic Constants 84**

- 3.5.1 Equal-Sign Directive 84
- 3.5.2 Calculating the Sizes of Arrays and Strings 85
- 3.5.3 EQU Directive 86
- 3.5.4 TEXTEQU Directive 87
- 3.5.5 Section Review 88

### **3.6 64-Bit Programming 88**

### **3.7 Chapter Summary 90**

### **3.8 Key Terms 91**

- 3.8.1 Terms 91
- 3.8.2 Instructions, Operators, and Directives 92

### **3.9 Review Questions and Exercises 92**

- 3.9.1 Short Answer 92
- 3.9.2 Algorithm Workbench 93

### **3.10 Programming Exercises 94**

## **4 Data Transfers, Addressing, and Arithmetic 95**

### **4.1 Data Transfer Instructions 96**

- 4.1.1 Introduction 96
- 4.1.2 Operand Types 96
- 4.1.3 Direct Memory Operands 96

- 4.1.4 MOV Instruction 98
- 4.1.5 Zero/Sign Extension of Integers 99
- 4.1.6 LAHF and SAHF Instructions 101
- 4.1.7 XCHG Instruction 102
- 4.1.8 Direct-Offset Operands 102
- 4.1.9 Example Program (Moves) 103
- 4.1.10 Section Review 104
- 4.2 Addition and Subtraction 105**
  - 4.2.1 INC and DEC Instructions 105
  - 4.2.2 ADD Instruction 105
  - 4.2.3 SUB Instruction 106
  - 4.2.4 NEG Instruction 106
  - 4.2.5 Implementing Arithmetic Expressions 106
  - 4.2.6 Flags Affected by Addition and Subtraction 107
  - 4.2.7 Example Program (*AddSubTest*) 111
  - 4.2.8 Section Review 112
- 4.3 Data-Related Operators and Directives 112**
  - 4.3.1 OFFSET Operator 112
  - 4.3.2 ALIGN Directive 113
  - 4.3.3 PTR Operator 114
  - 4.3.4 TYPE Operator 115
  - 4.3.5 LENGTHOF Operator 116
  - 4.3.6 SIZEOF Operator 116
  - 4.3.7 LABEL Directive 116
  - 4.3.8 Section Review 117
- 4.4 Indirect Addressing 117**
  - 4.4.1 Indirect Operands 117
  - 4.4.2 Arrays 118
  - 4.4.3 Indexed Operands 119
  - 4.4.4 Pointers 121
  - 4.4.5 Section Review 122
- 4.5 JMP and LOOP Instructions 123**
  - 4.5.1 JMP Instruction 123
  - 4.5.2 LOOP Instruction 124
  - 4.5.3 Displaying an Array in the Visual Studio Debugger 125
  - 4.5.4 Summing an Integer Array 126
  - 4.5.5 Copying a String 127
  - 4.5.6 Section Review 128
- 4.6 64-Bit Programming 128**
  - 4.6.1 MOV Instruction 128
  - 4.6.2 64-Bit Version of SumArray 130
  - 4.6.3 Addition and Subtraction 130
  - 4.6.4 Section Review 131

- 4.7 Chapter Summary 132**
- 4.8 Key Terms 133**
  - 4.8.1 Terms 133
  - 4.8.2 Instructions, Operators, and Directives 133
- 4.9 Review Questions and Exercises 134**
  - 4.9.1 Short Answer 134
  - 4.9.2 Algorithm Workbench 136
- 4.10 Programming Exercises 137**
- 5 Procedures 139**
- 5.1 Stack Operations 140**
  - 5.1.1 Runtime Stack (32-bit mode) 140
  - 5.1.2 PUSH and POP Instructions 142
  - 5.1.3 Section Review 145
- 5.2 Defining and Using Procedures 145**
  - 5.2.1 PROC Directive 145
  - 5.2.2 CALL and RET Instructions 147
  - 5.2.3 Nested Procedure Calls 148
  - 5.2.4 Passing Register Arguments to Procedures 150
  - 5.2.5 Example: Summing an Integer Array 150
  - 5.2.6 Saving and Restoring Registers 152
  - 5.2.7 Section Review 153
- 5.3 Linking to an External Library 153**
  - 5.3.1 Background Information 154
  - 5.3.2 Section Review 155
- 5.4 The Irvine32 Library 155**
  - 5.4.1 Motivation for Creating the Library 155
  - 5.4.2 Overview 157
  - 5.4.3 Individual Procedure Descriptions 158
  - 5.4.4 Library Test Programs 170
  - 5.4.5 Section Review 178
- 5.5 64-Bit Assembly Programming 178**
  - 5.5.1 The *Irvine64* Library 178
  - 5.5.2 Calling 64-Bit Subroutines 179
  - 5.5.3 The x64 Calling Convention 179
  - 5.5.4 Sample Program that Calls a Procedure 180
- 5.6 Chapter Summary 182**
- 5.7 Key Terms 183**
  - 5.7.1 Terms 183
  - 5.7.2 Instructions, Operators, and Directives 183

- 5.8 Review Questions and Exercises 183**
  - 5.8.1 Short Answer 183
  - 5.8.2 Algorithm Workbench 186
- 5.9 Programming Exercises 187**
- 6 Conditional Processing 189**
  - 6.1 Conditional Branching 190**
  - 6.2 Boolean and Comparison Instructions 190**
    - 6.2.1 The CPU Status Flags 191
    - 6.2.2 AND Instruction 191
    - 6.2.3 OR Instruction 192
    - 6.2.4 Bit-Mapped Sets 194
    - 6.2.5 XOR Instruction 195
    - 6.2.6 NOT Instruction 196
    - 6.2.7 TEST Instruction 196
    - 6.2.8 CMP Instruction 197
    - 6.2.9 Setting and Clearing Individual CPU Flags 198
    - 6.2.10 Boolean Instructions in 64-Bit Mode 199
    - 6.2.11 Section Review 199
  - 6.3 Conditional Jumps 199**
    - 6.3.1 Conditional Structures 199
    - 6.3.2 *Jcond* Instruction 200
    - 6.3.3 Types of Conditional Jump Instructions 201
    - 6.3.4 Conditional Jump Applications 204
    - 6.3.5 Section Review 208
  - 6.4 Conditional Loop Instructions 209**
    - 6.4.1 LOOPZ and LOOPE Instructions 209
    - 6.4.2 LOOPNZ and LOOPNE Instructions 209
    - 6.4.3 Section Review 210
  - 6.5 Conditional Structures 210**
    - 6.5.1 Block-Structured IF Statements 210
    - 6.5.2 Compound Expressions 213
    - 6.5.3 WHILE Loops 214
    - 6.5.4 Table-Driven Selection 216
    - 6.5.5 Section Review 219
  - 6.6 Application: Finite-State Machines 219**
    - 6.6.1 Validating an Input String 219
    - 6.6.2 Validating a Signed Integer 220
    - 6.6.3 Section Review 224
  - 6.7 Conditional Control Flow Directives 225**
    - 6.7.1 Creating IF Statements 226
    - 6.7.2 Signed and Unsigned Comparisons 227
    - 6.7.3 Compound Expressions 228
    - 6.7.4 Creating Loops with `.REPEAT` and `.WHILE` 231

- 6.8 Chapter Summary 232**
- 6.9 Key Terms 233**
  - 6.9.1 Terms 233
  - 6.9.2 Instructions, Operators, and Directives 234
- 6.10 Review Questions and Exercises 234**
  - 6.10.1 Short Answer 234
  - 6.10.2 Algorithm Workbench 236
- 6.11 Programming Exercises 237**
  - 6.11.1 Suggestions for Testing Your Code 237
  - 6.11.2 Exercise Descriptions 238
  
- 7 Integer Arithmetic 242**
  - 7.1 Shift and Rotate Instructions 243**
    - 7.1.1 Logical Shifts and Arithmetic Shifts 243
    - 7.1.2 SHL Instruction 244
    - 7.1.3 SHR Instruction 245
    - 7.1.4 SAL and SAR Instructions 246
    - 7.1.5 ROL Instruction 247
    - 7.1.6 ROR Instruction 247
    - 7.1.7 RCL and RCR Instructions 248
    - 7.1.8 Signed Overflow 249
    - 7.1.9 SHLD/SHRD Instructions 249
    - 7.1.10 Section Review 251
  - 7.2 Shift and Rotate Applications 251**
    - 7.2.1 Shifting Multiple Doublewords 252
    - 7.2.2 Binary Multiplication 253
    - 7.2.3 Displaying Binary Bits 254
    - 7.2.4 Extracting File Date Fields 254
    - 7.2.5 Section Review 255
  - 7.3 Multiplication and Division Instructions 255**
    - 7.3.1 MUL Instruction 255
    - 7.3.2 IMUL Instruction 257
    - 7.3.3 Measuring Program Execution Times 260
    - 7.3.4 DIV Instruction 262
    - 7.3.5 Signed Integer Division 264
    - 7.3.6 Implementing Arithmetic Expressions 267
    - 7.3.7 Section Review 269
  - 7.4 Extended Addition and Subtraction 269**
    - 7.4.1 ADC Instruction 269
    - 7.4.2 Extended Addition Example 270
    - 7.4.3 SBB Instruction 272
    - 7.4.4 Section Review 272

**7.5 ASCII and Unpacked Decimal Arithmetic 273**

- 7.5.1 AAA Instruction 274
- 7.5.2 AAS Instruction 276
- 7.5.3 AAM Instruction 276
- 7.5.4 AAD Instruction 276
- 7.5.5 Section Review 277

**7.6 Packed Decimal Arithmetic 277**

- 7.6.1 DAA Instruction 277
- 7.6.2 DAS Instruction 279
- 7.6.3 Section Review 279

**7.7 Chapter Summary 279****7.8 Key Terms 280**

- 7.8.1 Terms 280
- 7.8.2 Instructions, Operators, and Directives 280

**7.9 Review Questions and Exercises 281**

- 7.9.1 Short Answer 281
- 7.9.2 Algorithm Workbench 282

**7.10 Programming Exercises 284****8 Advanced Procedures 286****8.1 Introduction 287****8.2 Stack Frames 287**

- 8.2.1 Stack Parameters 288
- 8.2.2 Disadvantages of Register Parameters 288
- 8.2.3 Accessing Stack Parameters 290
- 8.2.4 32-Bit Calling Conventions 293
- 8.2.5 Local Variables 295
- 8.2.6 Reference Parameters 297
- 8.2.7 LEA Instruction 298
- 8.2.8 ENTER and LEAVE Instructions 298
- 8.2.9 LOCAL Directive 300
- 8.2.10 The Microsoft x64 Calling Convention 301
- 8.2.11 Section Review 302

**8.3 Recursion 302**

- 8.3.1 Recursively Calculating a Sum 303
- 8.3.2 Calculating a Factorial 304
- 8.3.3 Section Review 311

**8.4 INVOKE, ADDR, PROC, and PROTO 311**

- 8.4.1 INVOKE Directive 311
- 8.4.2 ADDR Operator 312
- 8.4.3 PROC Directive 313
- 8.4.4 PROTO Directive 316

- 8.4.5 Parameter Classifications 319
- 8.4.6 Example: Exchanging Two Integers 320
- 8.4.7 Debugging Tips 321
- 8.4.8 WriteStackFrame Procedure 322
- 8.4.9 Section Review 323
- 8.5 Creating Multimodule Programs 323**
  - 8.5.1 Hiding and Exporting Procedure Names 323
  - 8.5.2 Calling External Procedures 324
  - 8.5.3 Using Variables and Symbols across Module Boundaries 325
  - 8.5.4 Example: ArraySum Program 326
  - 8.5.5 Creating the Modules Using Extern 326
  - 8.5.6 Creating the Modules Using INVOKE and PROTO 330
  - 8.5.7 Section Review 333
- 8.6 Advanced Use of Parameters (Optional Topic) 333**
  - 8.6.1 Stack Affected by the USES Operator 333
  - 8.6.2 Passing 8-Bit and 16-Bit Arguments on the Stack 335
  - 8.6.3 Passing 64-Bit Arguments 336
  - 8.6.4 Non-Doubleword Local Variables 337
- 8.7 Java Bytecodes (Optional Topic) 339**
  - 8.7.1 Java Virtual Machine 339
  - 8.7.2 Instruction Set 340
  - 8.7.3 Java Disassembly Examples 341
  - 8.7.4 Example: Conditional Branch 344
- 8.8 Chapter Summary 346**
- 8.9 Key Terms 347**
  - 8.9.1 Terms 347
  - 8.9.2 Instructions, Operators, and Directives 348
- 8.10 Review Questions and Exercises 348**
  - 8.10.1 Short Answer 348
  - 8.10.2 Algorithm Workbench 348
- 8.11 Programming Exercises 349**
- 9 Strings and Arrays 352**
  - 9.1 Introduction 352**
  - 9.2 String Primitive Instructions 353**
    - 9.2.1 MOVSB, MOVSW, and MOVSD 354
    - 9.2.2 CMPSB, CMPSW, and CMPSD 355
    - 9.2.3 SCASB, SCASW, and SCASD 356
    - 9.2.4 STOSB, STOSW, and STOSD 356
    - 9.2.5 LODSB, LODSW, and LODSD 356
    - 9.2.6 Section Review 357



- 9.3 Selected String Procedures 357**
  - 9.3.1 Str\_compare Procedure 358
  - 9.3.2 Str\_length Procedure 359
  - 9.3.3 Str\_copy Procedure 359
  - 9.3.4 Str\_trim Procedure 360
  - 9.3.5 Str\_ucase Procedure 363
  - 9.3.6 *String Library Demo* Program 364
  - 9.3.7 String Procedures in the Irvine64 Library 365
  - 9.3.8 Section Review 368
- 9.4 Two-Dimensional Arrays 368**
  - 9.4.1 Ordering of Rows and Columns 368
  - 9.4.2 Base-Index Operands 369
  - 9.4.3 Base-Index-Displacement Operands 371
  - 9.4.4 Base-Index Operands in 64-Bit Mode 372
  - 9.4.5 Section Review 373
- 9.5 Searching and Sorting Integer Arrays 373**
  - 9.5.1 Bubble Sort 373
  - 9.5.2 Binary Search 375
  - 9.5.3 Section Review 382
- 9.6 Java Bytecodes: String Processing (Optional Topic) 382**
- 9.7 Chapter Summary 383**
- 9.8 Key Terms and Instructions 384**
- 9.9 Review Questions and Exercises 384**
  - 9.9.1 Short Answer 384
  - 9.9.2 Algorithm Workbench 385
- 9.10 Programming Exercises 386**
- 10 Structures and Macros 390**
  - 10.1 Structures 390**
    - 10.1.1 Defining Structures 391
    - 10.1.2 Declaring Structure Variables 393
    - 10.1.3 Referencing Structure Variables 394
    - 10.1.4 Example: Displaying the System Time 397
    - 10.1.5 Structures Containing Structures 399
    - 10.1.6 Example: Drunkard's Walk 399
    - 10.1.7 Declaring and Using Unions 403
    - 10.1.8 Section Review 405
  - 10.2 Macros 405**
    - 10.2.1 Overview 405
    - 10.2.2 Defining Macros 406
    - 10.2.3 Invoking Macros 407

---

10.2.4	Additional Macro Features	408
10.2.5	Using the Book's Macro Library (32-bit mode only)	412
10.2.6	Example Program: Wrappers	419
10.2.7	Section Review	420
<b>10.3</b>	<b>Conditional-Assembly Directives</b>	<b>420</b>
10.3.1	Checking for Missing Arguments	421
10.3.2	Default Argument Initializers	422
10.3.3	Boolean Expressions	423
10.3.4	IF, ELSE, and ENDIF Directives	423
10.3.5	The IFIDN and IFIDNI Directives	424
10.3.6	Example: Summing a Matrix Row	425
10.3.7	Special Operators	428
10.3.8	Macro Functions	431
10.3.9	Section Review	433
<b>10.4</b>	<b>Defining Repeat Blocks</b>	<b>433</b>
10.4.1	WHILE Directive	433
10.4.2	REPEAT Directive	434
10.4.3	FOR Directive	434
10.4.4	FORC Directive	435
10.4.5	Example: Linked List	436
10.4.6	Section Review	437
<b>10.5</b>	<b>Chapter Summary</b>	<b>438</b>
<b>10.6</b>	<b>Key Terms</b>	<b>439</b>
10.6.1	Terms	439
10.6.2	Operators and Directives	439
<b>10.7</b>	<b>Review Questions and Exercises</b>	<b>440</b>
10.7.1	Short Answer	440
10.7.2	Algorithm Workbench	440
<b>10.8</b>	<b>Programming Exercises</b>	<b>442</b>
<b>11</b>	<b>MS-Windows Programming</b>	<b>445</b>
<b>11.1</b>	<b>Win32 Console Programming</b>	<b>445</b>
11.1.1	Background Information	446
11.1.2	Win32 Console Functions	450
11.1.3	Displaying a Message Box	452
11.1.4	Console Input	455
11.1.5	Console Output	461
11.1.6	Reading and Writing Files	463
11.1.7	File I/O in the Irvine32 Library	468
11.1.8	Testing the File I/O Procedures	470
11.1.9	Console Window Manipulation	473
11.1.10	Controlling the Cursor	476

- 11.1.11 Controlling the Text Color 477
- 11.1.12 Time and Date Functions 479
- 11.1.13 Using the 64-Bit Windows API 482
- 11.1.14 Section Review 484

## **11.2 Writing a Graphical Windows Application 484**

- 11.2.1 Necessary Structures 484
- 11.2.2 The MessageBox Function 486
- 11.2.3 The WinMain Procedure 486
- 11.2.4 The WinProc Procedure 487
- 11.2.5 The ErrorHandler Procedure 488
- 11.2.6 Program Listing 488
- 11.2.7 Section Review 492

## **11.3 Dynamic Memory Allocation 492**

- 11.3.1 HeapTest Programs 496
- 11.3.2 Section Review 499

## **11.4 x86 Memory Management 499**

- 11.4.1 Linear Addresses 500
- 11.4.2 Page Translation 503
- 11.4.3 Section Review 505

## **11.5 Chapter Summary 505**

## **11.6 Key Terms 507**

## **11.7 Review Questions and Exercises 507**

- 11.7.1 Short Answer 507
- 11.7.2 Algorithm Workbench 508

## **11.8 Programming Exercises 509**

# **12 Floating-Point Processing and Instruction Encoding 511**

## **12.1 Floating-Point Binary Representation 511**

- 12.1.1 IEEE Binary Floating-Point Representation 512
- 12.1.2 The Exponent 514
- 12.1.3 Normalized Binary Floating-Point Numbers 514
- 12.1.4 Creating the IEEE Representation 514
- 12.1.5 Converting Decimal Fractions to Binary Reals 516
- 12.1.6 Section Review 518

## **12.2 Floating-Point Unit 518**

- 12.2.1 FPU Register Stack 519
- 12.2.2 Rounding 521
- 12.2.3 Floating-Point Exceptions 523
- 12.2.4 Floating-Point Instruction Set 523

---

12.2.5	Arithmetic Instructions	526
12.2.6	Comparing Floating-Point Values	530
12.2.7	Reading and Writing Floating-Point Values	533
12.2.8	Exception Synchronization	534
12.2.9	Code Examples	535
12.2.10	Mixed-Mode Arithmetic	537
12.2.11	Masking and Unmasking Exceptions	538
12.2.12	Section Review	539
<b>12.3</b>	<b>x86 Instruction Encoding</b>	<b>539</b>
12.3.1	Instruction Format	540
12.3.2	Single-Byte Instructions	541
12.3.3	Move Immediate to Register	541
12.3.4	Register-Mode Instructions	542
12.3.5	Processor Operand-Size Prefix	543
12.3.6	Memory-Mode Instructions	544
12.3.7	Section Review	547
<b>12.4</b>	<b>Chapter Summary</b>	<b>547</b>
<b>12.5</b>	<b>Key Terms</b>	<b>549</b>
<b>12.6</b>	<b>Review Questions and Exercises</b>	<b>549</b>
12.6.1	Short Answer	549
12.6.2	Algorithm Workbench	550
<b>12.7</b>	<b>Programming Exercises</b>	<b>551</b>
<b>13</b>	<b>High-Level Language Interface</b>	<b>555</b>
<b>13.1</b>	<b>Introduction</b>	<b>555</b>
13.1.1	General Conventions	556
13.1.2	.MODEL Directive	557
13.1.3	Examining Compiler-Generated Code	559
13.1.4	Section Review	564
<b>13.2</b>	<b>Inline Assembly Code</b>	<b>564</b>
13.2.1	__asm Directive in Visual C++	564
13.2.2	File Encryption Example	566
13.2.3	Section Review	569
<b>13.3</b>	<b>Linking 32-Bit Assembly Language Code to C/C++</b>	<b>570</b>
13.3.1	IndexOf Example	570
13.3.2	Calling C and C++ Functions	574
13.3.3	Multiplication Table Example	576
13.3.4	Calling C Library Functions	579
13.3.5	Directory Listing Program	582
13.3.6	Section Review	583

- 13.4 Chapter Summary 583**
- 13.5 Key Terms 584**
- 13.6 Review Questions 584**
- 13.7 Programming Exercises 585**

*Chapters are available from the Companion Web site*

## **14 16-Bit MS-DOS Programming 14.1**

### **14.1 MS-DOS and the IBM-PC 14.1**

- 14.1.1 Memory Organization 14.2
- 14.1.2 Redirecting Input-Output 14.3
- 14.1.3 Software Interrupts 14.4
- 14.1.4 INT Instruction 14.5
- 14.1.5 Coding for 16-Bit Programs 14.6
- 14.1.6 Section Review 14.7

### **14.2 MS-DOS Function Calls (INT 21h) 14.7**

- 14.2.1 Selected Output Functions 14.9
- 14.2.2 Hello World Program Example 14.11
- 14.2.3 Selected Input Functions 14.12
- 14.2.4 Date/Time Functions 14.16
- 14.2.5 Section Review 14.20

### **14.3 Standard MS-DOS File I/O Services 14.20**

- 14.3.1 Create or Open File (716Ch) 14.22
- 14.3.2 Close File Handle (3Eh) 14.23
- 14.3.3 Move File Pointer (42h) 14.23
- 14.3.4 Get File Creation Date and Time 14.24
- 14.3.5 Selected Library Procedures 14.24
- 14.3.6 Example: Read and Copy a Text File 14.25
- 14.3.7 Reading the MS-DOS Command Tail 14.27
- 14.3.8 Example: Creating a Binary File 14.30
- 14.3.9 Section Review 14.33

### **14.4 Chapter Summary 14.33**

### **14.5 Programming Exercises 14.35**

## **15 Disk Fundamentals 15.1**

### **15.1 Disk Storage Systems 15.1**

- 15.1.1 Tracks, Cylinders, and Sectors 15.2
- 15.1.2 Disk Partitions (Volumes) 15.4
- 15.1.3 Section Review 15.4

**15.2 File Systems 15.5**

- 15.2.1 FAT12 15.6
- 15.2.2 FAT16 15.6
- 15.2.3 FAT32 15.6
- 15.2.4 NTFS 15.7
- 15.2.5 Primary Disk Areas 15.7
- 15.2.6 Section Review 15.8

**15.3 Disk Directory 15.9**

- 15.3.1 MS-DOS Directory Structure 15.10
- 15.3.2 Long Filenames in MS-Windows 15.12
- 15.3.3 File Allocation Table (FAT) 15.14
- 15.3.4 Section Review 15.14

**15.4 Reading and Writing Disk Sectors 15.15**

- 15.4.1 Sector Display Program 15.16
- 15.4.2 Section Review 15.19

**15.5 System-Level File Functions 15.20**

- 15.5.1 Get Disk Free Space (7303h) 15.20
- 15.5.2 Create Subdirectory (39h) 15.23
- 15.5.3 Remove Subdirectory (3Ah) 15.23
- 15.5.4 Set Current Directory (3Bh) 15.23
- 15.5.5 Get Current Directory (47h) 15.24
- 15.5.6 Get and Set File Attributes (7143h) 15.24
- 15.5.7 Section Review 15.25

**15.6 Chapter Summary 15.25****15.7 Programming Exercises 15.26****16 BIOS-Level Programming 16.1****16.1 Introduction 16.1**

- 16.1.1 BIOS Data Area 16.2

**16.2 Keyboard Input with INT 16h 16.3**

- 16.2.1 How the Keyboard Works 16.3
- 16.2.2 INT 16h Functions 16.4
- 16.2.3 Section Review 16.8

**16.3 VIDEO Programming with INT 10h 16.8**

- 16.3.1 Basic Background 16.8
- 16.3.2 Controlling the Color 16.10
- 16.3.3 INT 10h Video Functions 16.12
- 16.3.4 Library Procedure Examples 16.22
- 16.3.5 Section Review 16.23

**16.4 Drawing Graphics Using INT 10h 16.23**

- 16.4.1 INT 10h Pixel-Related Functions 16.24
- 16.4.2 DrawLine Program 16.25
- 16.4.3 Cartesian Coordinates Program 16.27
- 16.4.4 Converting Cartesian Coordinates to Screen Coordinates 16.29
- 16.4.5 Section Review 16.30

**16.5 Memory-Mapped Graphics 16.30**

- 16.5.1 Mode 13h: 320 X 200, 256 Colors 16.30
- 16.5.2 Memory-Mapped Graphics Program 16.32
- 16.5.3 Section Review 16.34

**16.6 Mouse Programming 16.35**

- 16.6.1 Mouse INT 33h Functions 16.35
- 16.6.2 Mouse Tracking Program 16.40
- 16.6.3 Section Review 16.44

**16.7 Chapter Summary 16.45****16.8 Programming Exercises 16.46****17 Expert MS-DOS Programming 17.1****17.1 Introduction 17.1****17.2 Defining Segments 17.2**

- 17.2.1 Simplified Segment Directives 17.2
- 17.2.2 Explicit Segment Definitions 17.4
- 17.2.3 Segment Overrides 17.7
- 17.2.4 Combining Segments 17.7
- 17.2.5 Section Review 17.9

**17.3 Runtime Program Structure 17.9**

- 17.3.1 Program Segment Prefix 17.10
- 17.3.2 COM Programs 17.10
- 17.3.3 EXE Programs 17.11
- 17.3.4 Section Review 17.13

**17.4 Interrupt Handling 17.13**

- 17.4.1 Hardware Interrupts 17.14
- 17.4.2 Interrupt Control Instructions 17.16
- 17.4.3 Writing a Custom Interrupt Handler 17.16
- 17.4.4 Terminate and Stay Resident Programs 17.19
- 17.4.5 Application: The No\_Reset Program 17.19
- 17.4.6 Section Review 17.23

**17.5 Hardware Control Using I/O Ports 17.23**

- 17.5.1 Input-Output Ports 17.24
- 17.5.2 PC Sound Program 17.24

**17.6 Chapter Summary 17.26**

---

<b>Appendix A</b>	<b>MASM Reference</b>	<b>587</b>
<b>Appendix B</b>	<b>The x86 Instruction Set</b>	<b>609</b>
<b>Appendix C</b>	<b>Answers to Section Review Questions</b>	<b>644</b>

*Appendices are available from the Companion Web site*

<b>Appendix D</b>	<b>BIOS and MS-DOS Interrupts</b>	<b>D.1</b>
<b>Appendix E</b>	<b>Answers to Review Questions (Chapters 14–17)</b>	<b>E.1</b>
<b>Index</b>	<b>664</b>	



*This page intentionally left blank*

# PREFACE

---

*Assembly Language for x86 Processors, Seventh Edition*, teaches assembly language programming and architecture for x86 and Intel64 processors. It is an appropriate text for the following types of college courses:

- Assembly Language Programming
- Fundamentals of Computer Systems
- Fundamentals of Computer Architecture

Students use Intel or AMD processors and program with **Microsoft Macro Assembler (MASM)**, running on recent versions of Microsoft Windows. Although this book was originally designed as a programming textbook for college students, it serves as an effective supplement to computer architecture courses. As a testament to its popularity, previous editions have been translated into numerous languages.

*Emphasis of Topics* This edition includes topics that lead naturally into subsequent courses in computer architecture, operating systems, and compiler writing:

- Virtual machine concept
- Instruction set architecture
- Elementary Boolean operations
- Instruction execution cycle
- Memory access and handshaking
- Interrupts and polling
- Hardware-based I/O
- Floating-point binary representation

Other topics relate specially to x86 and Intel64 architecture:

- Protected memory and paging
- Memory segmentation in real-address mode
- 16-Bit interrupt handling
- MS-DOS and BIOS system calls (interrupts)
- Floating-point unit architecture and programming
- Instruction encoding

Certain examples presented in the book lend themselves to courses that occur later in a computer science curriculum:

- Searching and sorting algorithms
- High-level language structures

- Finite-state machines
- Code optimization examples

## What's New in the Seventh Edition

In this revision, we increased the discussions of program examples early in the book, added more supplemental review questions and key terms, introduced 64-bit programming, and reduced our dependence on the book's subroutine library. To be more specific, here are the details:

- Early chapters now include short sections that feature 64-bit CPU architecture and programming, and we have created a 64-bit version of the book's subroutine library named *Irvine64*.
- Many of the review questions and exercises have been modified, replaced, and moved from the middle of the chapter to the end of chapters, and divided into two sections: (1) Short answer questions, and (2) Algorithm workbench exercises. The latter exercises require the student to write a short amount of code to accomplish a goal.
- Each chapter now has a *Key Terms* section, listing new terms and concepts, as well as new MASM directives and Intel instructions.
- New programming exercises have been added, others removed, and a few existing exercises were modified.
- There is far less dependency on the author's subroutine libraries in this edition. Students are encouraged to call system functions themselves and use the Visual Studio debugger to step through the programs. The *Irvine32* and *Irvine64* libraries are available to help students handle input/output, but their use is not required.
- New tutorial videos covering essential content topics have been created by the author and added to the Pearson website.

This book is still focused on its primary goal, to teach students how to write and debug programs at the machine level. It will never replace a complete book on computer architecture, but it does give students the first-hand experience of writing software in an environment that teaches them how a computer works. Our premise is that students retain knowledge better when theory is combined with experience. In an engineering course, students construct prototypes; in a computer architecture course, students should write machine-level programs. In both cases, they have a memorable experience that gives them the confidence to work in any OS/machine-oriented environment.

Protected mode programming is entirely the focus of the printed chapters (1 through 13). As such, students will create 32-bit and 64-bit programs that run under the most recent versions of Microsoft Windows. The remaining four chapters cover 16-bit programming, and are supplied in electronic form. These chapters cover BIOS programming, MS-DOS services, keyboard and mouse input, video programming, and graphics. One chapter covers disk storage fundamentals. Another chapter covers advanced DOS programming techniques.

**Subroutine Libraries** We supply three versions of the subroutine library that students use for basic input/output, simulations, timing, and other useful tasks. The *Irvine32* and *Irvine64* libraries run in protected mode. The 16-bit version (*Irvine16.lib*) runs in real-address mode and is used only by Chapters 14 through 17. Full source code for the libraries is supplied on the companion website. The link libraries are available only for convenience, not to prevent students from learning how to program input–output themselves. Students are encouraged to create their own libraries.

**Included Software and Examples** All the example programs were tested with Microsoft Macro Assembler Version 11.0, running in Microsoft Visual Studio 2012. In addition, batch files are supplied that permit students to assemble and run applications from the Windows command

prompt. The 32-bit C++ applications in Chapter 14 were tested with Microsoft Visual C++ .NET. Information Updates and corrections to this book may be found at the Companion Web site, including additional programming projects for instructors to assign at the ends of chapters.

## Overall Goals

The following goals of this book are designed to broaden the student's interest and knowledge in topics related to assembly language:

- Intel and AMD processor architecture and programming
- Real-address mode and protected mode programming
- Assembly language directives, macros, operators, and program structure
- Programming methodology, showing how to use assembly language to create system-level software tools and application programs
- Computer hardware manipulation
- Interaction between assembly language programs, the operating system, and other application programs

One of our goals is to help students approach programming problems with a machine-level mind set. It is important to think of the CPU as an interactive tool, and to learn to monitor its operation as directly as possible. A debugger is a programmer's best friend, not only for catching errors, but as an educational tool that teaches about the CPU and operating system. We encourage students to look beneath the surface of high-level languages and to realize that most programming languages are designed to be portable and, therefore, independent of their host machines. In addition to the short examples, this book contains hundreds of ready-to-run programs that demonstrate instructions or ideas as they are presented in the text. Reference materials, such as guides to MS-DOS interrupts and instruction mnemonics, are available at the end of the book.

*Required Background* The reader should already be able to program confidently in at least one high-level programming language such as Python, Java, C, or C++. One chapter covers C++ interfacing, so it is very helpful to have a compiler on hand. I have used this book in the classroom with majors in both computer science and management information systems, and it has been used elsewhere in engineering courses.

## Features

*Complete Program Listings* The Companion Web site contains supplemental learning materials, study guides, and all the source code from the book's examples. An extensive link library is supplied with the book, containing more than 30 procedures that simplify user input–output, numeric processing, disk and file handling, and string handling. In the beginning stages of the course, students can use this library to enhance their programs. Later, they can create their own procedures and add them to the library.

*Programming Logic* Two chapters emphasize Boolean logic and bit-level manipulation. A conscious attempt is made to relate high-level programming logic to the low-level details of the machine. This approach helps students to create more efficient implementations and to better understand how compilers generate object code.

**Hardware and Operating System Concepts** The first two chapters introduce basic hardware and data representation concepts, including binary numbers, CPU architecture, status flags, and memory mapping. A survey of the computer's hardware and a historical perspective of the Intel processor family helps students to better understand their target computer system.

**Structured Programming Approach** Beginning with Chapter 5, procedures and functional decomposition are emphasized. Students are given more complex programming exercises, requiring them to focus on design before starting to write code.

**Java Bytecodes and the Java Virtual Machine** In Chapters 8 and 9, the author explains the basic operation of Java bytecodes with short illustrative examples. Numerous short examples are shown in disassembled bytecode format, followed by detailed step-by-step explanations.

**Disk Storage Concepts** Students learn the fundamental principles behind the disk storage system on MS-Windows-based systems from hardware and software points of view.

**Creating Link Libraries** Students are free to add their own procedures to the book's link library and create new libraries. They learn to use a toolbox approach to programming and to write code that is useful in more than one program.

**Macros and Structures** A chapter is devoted to creating structures, unions, and macros, which are essential in assembly language and systems programming. Conditional macros with advanced operators serve to make the macros more professional.

**Interfacing to High-Level Languages** A chapter is devoted to interfacing assembly language to C and C++. This is an important job skill for students who are likely to find jobs programming in high-level languages. They can learn to optimize their code and see examples of how C++ compilers optimize code.

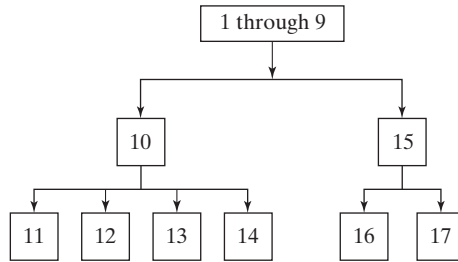
**Instructional Aids** All the program listings are available on the Web. Instructors are provided a test bank, answers to review questions, solutions to programming exercises, and a Microsoft PowerPoint slide presentation for each chapter.

**VideoNotes** VideoNotes are Pearson's new visual tool designed to teach students key programming concepts and techniques. These short step-by-step videos demonstrate basic assembly language concepts. VideoNotes allow for self-paced instruction with easy navigation including the ability to select, play, rewind, fast-forward, and stop within each VideoNote exercise.

VideoNotes are free with the purchase of a new textbook. To *purchase* access to VideoNotes, go to [www.pearsonhighered.com/irvine](http://www.pearsonhighered.com/irvine) and click on the VideoNotes under *Student Resources*.

## Chapter Descriptions

Chapters 1 to 8 contain core concepts of assembly language and should be covered in sequence. After that, you have a fair amount of freedom. The following chapter dependency graph shows how later chapters depend on knowledge gained from other chapters.



- 1. Basic Concepts:** Applications of assembly language, basic concepts, machine language, and data representation.
- 2. x86 Processor Architecture:** Basic microcomputer design, instruction execution cycle, x86 processor architecture, Intel64 architecture, x86 memory management, components of a microcomputer, and the input–output system.
- 3. Assembly Language Fundamentals:** Introduction to assembly language, linking and debugging, and defining constants and variables.
- 4. Data Transfers, Addressing, and Arithmetic:** Simple data transfer and arithmetic instructions, assemble-link-execute cycle, operators, directives, expressions, JMP and LOOP instructions, and indirect addressing.
- 5. Procedures:** Linking to an external library, description of the book’s link library, stack operations, defining and using procedures, flowcharts, and top-down structured design.
- 6. Conditional Processing:** Boolean and comparison instructions, conditional jumps and loops, high-level logic structures, and finite-state machines.
- 7. Integer Arithmetic:** Shift and rotate instructions with useful applications, multiplication and division, extended addition and subtraction, and ASCII and packed decimal arithmetic.
- 8. Advanced Procedures:** Stack parameters, local variables, advanced PROC and INVOKE directives, and recursion.
- 9. Strings and Arrays:** String primitives, manipulating arrays of characters and integers, two-dimensional arrays, sorting, and searching.
- 10. Structures and Macros:** Structures, macros, conditional assembly directives, and defining repeat blocks.
- 11. MS-Windows Programming:** Protected mode memory management concepts, using the Microsoft-Windows API to display text and colors, and dynamic memory allocation.
- 12. Floating-Point Processing and Instruction Encoding:** Floating-point binary representation and floating-point arithmetic. Learning to program the IA-32 floating-point unit. Understanding the encoding of IA-32 machine instructions.
- 13. High-Level Language Interface:** Parameter passing conventions, inline assembly code, and linking assembly language modules to C and C++ programs.
  - **Appendix A:** MASM Reference
  - **Appendix B:** The x86 Instruction Set
  - **Appendix C:** Answers to Review Questions

The following chapters and appendices are supplied online at the Companion Web site:

- 14. 16-Bit MS-DOS Programming:** Memory organization, interrupts, function calls, and standard MS-DOS file I/O services.
- 15. Disk Fundamentals:** Disk storage systems, sectors, clusters, directories, file allocation tables, handling MS-DOS error codes, and drive and directory manipulation.
- 16. BIOS-Level Programming:** Keyboard input, video text, graphics, and mouse programming.
- 17. Expert MS-DOS Programming:** Custom-designed segments, runtime program structure, and Interrupt handling. Hardware control using I/O ports.
  - **Appendix D:** BIOS and MS-DOS Interrupts
  - **Appendix E:** Answers to Review Questions (Chapters 14–17)

## Instructor and Student Resources

### *Instructor Resource Materials*

The following protected instructor material is available on the Companion Web site:

[www.pearsonhighered.com/irvine](http://www.pearsonhighered.com/irvine)

For username and password information, please contact your Pearson Representative.

- Lecture PowerPoint Slides
- Instructor Solutions Manual

### *Student Resource Materials*

The student resource materials can be accessed through the publisher's Web site located at [www.pearsonhighered.com/irvine](http://www.pearsonhighered.com/irvine). These resources include:

- VideoNotes
- Online Chapters and Appendices
  - Chapter 14: *16-Bit MS-DOS Programming*
  - Chapter 15: *Disk Fundamentals*
  - Chapter 16: *BIOS-Level Programming*
  - Chapter 17: *Expert MS-DOS Programming*
  - Appendix D: *BIOS and MS-DOS Interrupts*
  - Appendix E: *Answers to Review Questions (Chapters 14–17)*

Students must use the access card located in the front of the book to register and access the online chapters and VideoNotes. If there is no access card in the front of this textbook, students can purchase access by going to [www.pearsonhighered.com/irvine](http://www.pearsonhighered.com/irvine) and selecting “Video Notes and Web Chapters.” Instructors must also register on the site to access this material. Students will also find a link to the author's Web site. An access card is not required for the following materials, located at [www.asmirvine.com](http://www.asmirvine.com):

- *Getting Started*, a comprehensive step-by-step tutorial that helps students customize Visual Studio for assembly language programming.
- Supplementary articles on assembly language programming topics.
- Complete source code for all example programs in the book, as well as the source code for the author's supplementary library.

- *Assembly Language Workbook*, an interactive workbook covering number conversions, addressing modes, register usage, debug programming, and floating-point binary numbers. Content pages are HTML documents to allow for customization. Help File in Windows Help Format.
- Debugging Tools: Tutorials on using the Microsoft Visual Studio debugger.

## **Acknowledgments**

Many thanks are due to Tracy Johnson, Executive Editor for Computer Science at Pearson Education, who has provided friendly, helpful guidance over the past few years. Pavithra Jayapaul of Jouve did an excellent job on the book production, along with Greg Dulles as the production editor at Pearson.

## **Previous Editions**

I offer my special thanks to the following individuals who were most helpful during the development of earlier editions of this book:

- William Barrett, San Jose State University
- Scott Blackledge
- James Brink, Pacific Lutheran University
- Gerald Cahill, Antelope Valley College
- John Taylor



*This page intentionally left blank*

# ABOUT THE AUTHOR

---

Kip Irvine has written five computer programming textbooks, for Intel Assembly Language, C++, Visual Basic (beginning and advanced), and COBOL. His book *Assembly Language for Intel-Based Computers* has been translated into six languages. His first college degrees (B.M., M.M., and doctorate) were in Music Composition, at University of Hawaii and University of Miami. He began programming computers for music synthesis around 1982 and taught programming at Miami-Dade Community College for 17 years. Kip earned an M.S. degree in Computer Science from the University of Miami, and he has been a full-time member of the faculty in the School of Computing and Information Sciences at Florida International University since 2000.

*This page intentionally left blank*

---

# BASIC CONCEPTS

- 1.1 **Welcome to Assembly Language**
  - 1.1.1 Questions You Might Ask
  - 1.1.2 Assembly Language Applications
  - 1.1.3 Section Review
- 1.2 **Virtual Machine Concept**
  - 1.2.1 Section Review
- 1.3 **Data Representation**
  - 1.3.1 Binary Integers
  - 1.3.2 Binary Addition
  - 1.3.3 Integer Storage Sizes
  - 1.3.4 Hexadecimal Integers
  - 1.3.5 Hexadecimal Addition
  - 1.3.6 Signed Binary Integers
  - 1.3.7 Binary Subtraction
  - 1.3.8 Character Storage
  - 1.3.9 Section Review
- 1.4 **Boolean Expressions**
  - 1.4.1 Truth Tables for Boolean Functions
  - 1.4.2 Section Review
- 1.5 **Chapter Summary**
- 1.6 **Key Terms**
- 1.7 **Review Questions and Exercises**
  - 1.7.1 Short Answer
  - 1.7.2 Algorithm Workbench

This chapter establishes some core concepts relating to assembly language programming. For example, it shows how assembly language fits into the wide spectrum of languages and applications. We introduce the virtual machine concept, which is so important in understanding the relationship between software and hardware layers. A large part of the chapter is devoted to the binary and hexadecimal numbering systems, showing how to perform conversions and do basic arithmetic. Finally, this chapter introduces fundamental boolean operations (AND, OR, NOT, XOR), which will prove to be essential in later chapters.

## 1.1 Welcome to Assembly Language

*Assembly Language for x86 Processors* focuses on programming microprocessors compatible with Intel and AMD processors running under 32-bit and 64-bit versions of Microsoft Windows.

The latest version of *Microsoft Macro Assembler* (known as *MASM*) should be used with this book. *MASM* is included with most versions of Microsoft Visual Studio (Pro, Ultimate, Express, . . . ). Please check our web site ([asmirvine.com](http://asmirvine.com)) for the latest details about support for *MASM* in Visual Studio. We also include lots of helpful information about how to set up your software and get started.

Some other well-known assemblers for x86 systems running under Microsoft Windows include *TASM* (Turbo Assembler), *NASM* (Netwide Assembler), and *MASM32* (a variant of *MASM*). Two popular Linux-based assemblers are *GAS* (GNU assembler) and *NASM*. Of these, *NASM*'s syntax is most similar to that of *MASM*.

Assembly language is the oldest programming language, and of all languages, bears the closest resemblance to native machine language. It provides direct access to computer hardware, requiring you to understand much about your computer's architecture and operating system.

*Educational Value* Why read this book? Perhaps you're taking a college course whose title is similar to one of the following courses that often use our book:

- Microcomputer Assembly Language
- Assembly Language Programming
- Introduction to Computer Architecture
- Fundamentals of Computer Systems
- Embedded Systems Programming

This book will help you learn basic principles about computer architecture, machine language, and low-level programming. You will learn enough assembly language to test your knowledge on today's most widely used microprocessor family. You won't be learning to program a "toy" computer using a simulated assembler; *MASM* is an industrial-strength assembler, used by practicing professionals. You will learn the architecture of the Intel processor family from a programmer's point of view.

If you are planning to be a C or C++ developer, you need to develop an understanding of how memory, address, and instructions work at a low level. A lot of programming errors are not easily recognized at the high-level language level. You will often find it necessary to "drill down" into your program's internals to find out why it isn't working.

If you doubt the value of low-level programming and studying details of computer software and hardware, take note of the following quote from a leading computer scientist, Donald Knuth, in discussing his famous book series, *The Art of Computer Programming*:

Some people [say] that having machine language, at all, was the great mistake that I made. I really don't think you can write a book for serious computer programmers unless you are able to discuss low-level detail.<sup>1</sup>

Visit this book's web site to get lots of supplemental information, tutorials, and exercises at [www.asmirvine.com](http://www.asmirvine.com)

### 1.1.1 Questions You Might Ask

**What Background Should I Have?** Before reading this book, you should have programmed in at least one structured high-level language, such as Java, C, Python, or C++. You should know how to use IF statements, arrays, and functions to solve programming problems.

**What Are Assemblers and Linkers?** An *assembler* is a utility program that converts source code programs from assembly language into machine language. A *linker* is a utility program that combines individual files created by an assembler into a single executable program. A related utility, called a *debugger*, lets you to step through a program while it's running and examine registers and memory.

**What Hardware and Software Do I Need?** You need a computer that runs a 32-bit or 64-bit version of Microsoft Windows, along with one of the recent versions of Microsoft Visual Studio.

**What Types of Programs Can Be Created Using MASM?**

- **32-Bit Protected Mode:** 32-bit protected mode programs run under all 32-bit versions of Microsoft Windows. They are usually easier to write and understand than real-mode programs. From now on, we will simply call this *32-bit mode*.
- **64-Bit Mode:** 64-bit programs run under all 64-bit versions of Microsoft Windows.
- **16-Bit Real-Address Mode:** 16-bit programs run under 32-bit versions of Windows and on embedded systems. Because they are not supported by 64-bit Windows, we will restrict discussions of this mode to Chapters 14 through 17. These chapters are in electronic form, available from the publisher's web site.

**What Supplements Are Supplied with This Book?** The book's web site ([www.asmirvine.com](http://www.asmirvine.com)) has the following:

- **Assembly Language Workbook**, a collection of tutorials
- **Irvine32, Irvine64, and Irvine16 subroutine libraries** for 64-bit, 32-bit, and 16-bit programming, with complete source code
- **Example programs** with all source code from the book
- **Corrections** to the book
- **Getting Started**, a detailed tutorial designed to help you set up Visual Studio to use the Microsoft assembler
- **Articles** on advanced topics not included in the printed book for lack of space
- **A link to an online discussion forum**, where you can get help from other experts who use the book

**What Will I Learn?** This book should make you better informed about data representation, debugging, programming, and hardware manipulation. Here's what you will learn:

- Basic principles of computer architecture as applied to x86 processors
- Basic boolean logic and how it applies to programming and computer hardware
- How x86 processors manage memory, using protected mode and virtual mode
- How high-level language compilers (such as C++) translate statements from their language into assembly language and native machine code

- How high-level languages implement arithmetic expressions, loops, and logical structures at the machine level
- Data representation, including signed and unsigned integers, real numbers, and character data
- How to debug programs at the machine level. The need for this skill is vital when you work in languages such as C and C++, which generate native machine code
- How application programs communicate with the computer's operating system via interrupt handlers and system calls
- How to interface assembly language code to C++ programs
- How to create assembly language application programs

*How Does Assembly Language Relate to Machine Language?* *Machine language* is a numeric language specifically understood by a computer's processor (the CPU). All x86 processors understand a common machine language. *Assembly language* consists of statements written with short mnemonics such as ADD, MOV, SUB, and CALL. Assembly language has a *one-to-one* relationship with machine language: Each assembly language instruction corresponds to a single machine-language instruction.

*How Do C++ and Java Relate to Assembly Language?* High-level languages such as Python, C++, and Java have a *one-to-many* relationship with assembly language and machine language. A single statement in C++, for example, expands into multiple assembly language or machine instructions. Most people cannot read raw machine code, so in this book, we examine its closest relative, assembly language. For example, the following C++ code carries out two arithmetic operations and assigns the result to a variable. Assume X and Y are integers:

```
int Y;  
int X = (Y + 4) * 3;
```

Following is the equivalent translation to assembly language. The translation requires multiple statements because each assembly language statement corresponds to a single machine instruction:

```
mov    eax, Y                ; move Y to the EAX register  
add    eax, 4                ; add 4 to the EAX register  
mov    ebx, 3                ; move 3 to the EBX register  
imul  ebx                    ; multiply EAX by EBX  
mov    X, eax                ; move EAX to X
```

(*Registers* are named storage locations in the CPU that hold intermediate results of operations.) The point of this example is not to claim that C++ is superior to assembly language or vice versa, but to show their relationship.

*Is Assembly Language Portable?* A language whose source programs can be compiled and run on a wide variety of computer systems is said to be *portable*. A C++ program, for example, will compile and run on just about any computer, unless it makes specific references to library functions that exist under a single operating system. A major feature of the Java language is that compiled programs run on nearly any computer system.

Assembly language is not portable, because it is designed for a specific processor family. There are a number of different assembly languages widely used today, each based on a processor family.

Some well-known processor families are Motorola 68x00, x86, SUN Sparc, Vax, and IBM-370. The instructions in assembly language may directly match the computer's architecture or they may be translated during execution by a program inside the processor known as a *microcode interpreter*.

*Why Learn Assembly Language?* If you're still not convinced that you should learn assembly language, consider the following points:

- If you study computer engineering, you may likely be asked to write *embedded* programs. They are short programs stored in a small amount of memory in single-purpose devices such as telephones, automobile fuel and ignition systems, air-conditioning control systems, security systems, data acquisition instruments, video cards, sound cards, hard drives, modems, and printers. Assembly language is an ideal tool for writing embedded programs because of its economical use of memory.
- Real-time applications dealing with simulation and hardware monitoring require precise timing and responses. High-level languages do not give programmers exact control over machine code generated by compilers. Assembly language permits you to precisely specify a program's executable code.
- Computer game consoles require their software to be highly optimized for small code size and fast execution. Game programmers are experts at writing code that takes full advantage of hardware features in a target system. They often use assembly language as their tool of choice because it permits direct access to computer hardware, and code can be hand optimized for speed.
- Assembly language helps you to gain an overall understanding of the interaction between computer hardware, operating systems, and application programs. Using assembly language, you can apply and test theoretical information you are given in computer architecture and operating systems courses.
- Some high-level languages abstract their data representation to the point that it becomes awkward to perform low-level tasks such as bit manipulation. In such an environment, programmers will often call subroutines written in assembly language to accomplish their goal.
- Hardware manufacturers create device drivers for the equipment they sell. *Device drivers* are programs that translate general operating system commands into specific references to hardware details. Printer manufacturers, for example, create a different MS-Windows device driver for each model they sell. Often these device drivers contain significant amounts of assembly language code.

*Are There Rules in Assembly Language?* Most rules in assembly language are based on physical limitations of the target processor and its machine language. The CPU, for example, requires two instruction operands to be the same size. Assembly language has fewer rules than C++ or Java because the latter use syntax rules to reduce unintended logic errors at the expense of low-level data access. Assembly language programmers can easily bypass restrictions characteristic of high-level languages. Java, for example, does not permit access to specific memory addresses. One can work around the restriction by calling a C function using JNI (*Java Native Interface*) classes, but the resulting program can be awkward to maintain. Assembly language, on the other hand, can access any memory address. The price for such freedom is high: Assembly language programmers spend a lot of time debugging!



### 1.1.2 Assembly Language Applications

In the early days of programming, most applications were written partially or entirely in assembly language. They had to fit in a small area of memory and run as efficiently as possible on slow processors. As memory became more plentiful and processors dramatically increased in speed, programs became more complex. Programmers switched to high-level languages such as C, FORTRAN, and COBOL that contained a certain amount of structuring capability. More recently, object-oriented languages such as Python, C++, C#, and Java have made it possible to write complex programs containing millions of lines of code.

It is rare to see large application programs coded completely in assembly language because they would take too much time to write and maintain. Instead, assembly language is used to optimize certain sections of application programs for speed and to access computer hardware. Table 1-1 compares the adaptability of assembly language to high-level languages in relation to various types of applications.

Table 1-1 Comparison of Assembly Language to High-Level Languages.

Type of Application	High-Level Languages	Assembly Language
Commercial or scientific application, written for single platform, medium to large size.	Formal structures make it easy to organize and maintain large sections of code.	Minimal formal structure, so one must be imposed by programmers who have varying levels of experience. This leads to difficulties maintaining existing code.
Hardware device driver.	The language may not provide for direct hardware access. Even if it does, awkward coding techniques may be required, resulting in maintenance difficulties.	Hardware access is straightforward and simple. Easy to maintain when programs are short and well documented.
Commercial or scientific application written for multiple platforms (different operating systems).	Usually portable. The source code can be recompiled on each target operating system with minimal changes.	Must be recoded separately for each platform, using an assembler with a different syntax. Difficult to maintain.
Embedded systems and computer games requiring direct hardware access.	May produce large executable files that exceed the memory capacity of the device.	Ideal, because the executable code is small and runs quickly.

The C and C++ languages have the unique quality of offering a compromise between high-level structure and low-level details. Direct hardware access is possible but completely nonportable. Most C and C++ compilers allow you to embed assembly language statements in their code, providing access to hardware details.

### 1.1.3 Section Review

1. How do assemblers and linkers work together?
2. How will studying assembly language enhance your understanding of operating systems?

3. What is meant by a *one-to-many relationship* when comparing a high-level language to machine language?
4. Explain the concept of *portability* as it applies to programming languages.
5. Is the assembly language for x86 processors the same as those for computer systems such as the Vax or Motorola 68x00?
6. Give an example of an embedded systems application.
7. What is a device driver?
8. Do you suppose type checking on pointer variables is stronger (stricter) in assembly language, or in C and C++?
9. Name two types of applications that would be better suited to assembly language than a high-level language.
10. Why would a high-level language not be an ideal tool for writing a program that directly accesses a printer port?
11. Why is assembly language not usually used when writing large application programs?
12. *Challenge:* Translate the following C++ expression to assembly language, using the example presented earlier in this chapter as a guide:  $X = (Y * 4) + 3$ .

## 1.2 Virtual Machine Concept

An effective way to explain how a computer's hardware and software are related is called the *virtual machine concept*. A well-known explanation of this model can be found in Andrew Tanenbaum's book, *Structured Computer Organization*. To explain this concept, let us begin with the most basic function of a computer, executing programs.

A computer can usually execute programs written in its native *machine language*. Each instruction in this language is simple enough to be executed using a relatively small number of electronic circuits. For simplicity, we will call this language **L0**.

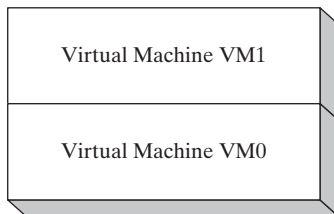
Programmers would have a difficult time writing programs in L0 because it is enormously detailed and consists purely of numbers. If a new language, **L1**, could be constructed that was easier to use, programs could be written in L1. There are two ways to achieve this:

- *Interpretation:* As the L1 program is running, each of its instructions could be decoded and executed by a program written in language L0. The L1 program begins running immediately, but each instruction has to be decoded before it can execute.
- *Translation:* The entire L1 program could be converted into an L0 program by an L0 program specifically designed for this purpose. Then the resulting L0 program could be executed directly on the computer hardware.

### **Virtual Machines**

Rather than using only languages, it is easier to think in terms of a hypothetical computer, or *virtual machine*, at each level. Informally, we can define a virtual machine as a software program that emulates the functions of some other physical or virtual computer. The virtual machine

**VM1**, as we will call it, can execute commands written in language L1. The virtual machine **VM0** can execute commands written in language L0:



Each virtual machine can be constructed of either hardware or software. People can write programs for virtual machine VM1, and if it is practical to implement VM1 as an actual computer, programs can be executed directly on the hardware. Or programs written in VM1 can be interpreted/translated and executed on machine VM0.

Machine VM1 cannot be radically different from VM0 because the translation or interpretation would be too time-consuming. What if the language VM1 supports is still not programmer-friendly enough to be used for useful applications? Then another virtual machine, VM2, can be designed that is more easily understood. This process can be repeated until a virtual machine  $VM_n$  can be designed to support a powerful, easy-to-use language.

The Java programming language is based on the virtual machine concept. A program written in the Java language is translated by a Java compiler into *Java byte code*. The latter is a low-level language quickly executed at runtime by a program known as a *Java virtual machine (JVM)*. The JVM has been implemented on many different computer systems, making Java programs relatively system independent.

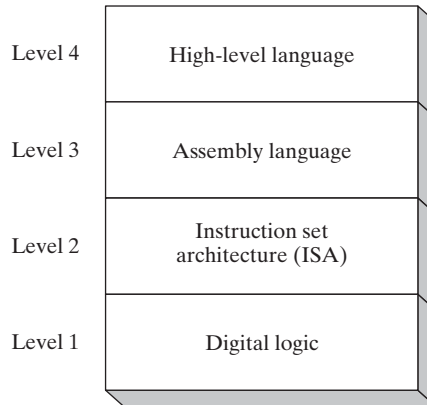
### **Specific Machines**

Let us relate this to actual computers and languages, using names such as **Level 2** for VM2 and **Level 1** for VM1, shown in Figure 1-1. A computer's digital logic hardware represents machine Level 1. Above this is Level 2, called the *instruction set Architecture (ISA)*. This is the first level at which users can typically write programs, although the programs consist of binary values called *machine language*.

**Instruction Set Architecture (Level 2)** Computer chip manufacturers design into the processor an instruction set to carry out basic operations, such as move, add, or multiply. This set of instructions is also referred to as *machine language*. Each machine-language instruction is executed either directly by the computer's hardware or by a program embedded in the microprocessor chip called a *microprogram*. A discussion of microprograms is beyond the scope of this book, but you can refer to Tanenbaum for more details.

**Assembly Language (Level 3)** Above the ISA level, programming languages provide translation layers to make large-scale software development practical. Assembly language, which appears at Level 3, uses short mnemonics such as ADD, SUB, and MOV, which are easily translated to the ISA level. Assembly language programs are translated (assembled) in their entirety into machine language before they begin to execute.

FIGURE 1-1 Virtual machine levels.



**High-Level Languages (Level 4)** At Level 4 are high-level programming languages such as C, C++, and Java. Programs in these languages contain powerful statements that translate into multiple assembly language instructions. You can see such a translation, for example, by examining the listing file output created by a C++ compiler. The assembly language code is automatically assembled by the compiler into machine language.

### 1.2.1 Section Review

1. In your own words, describe the *virtual machine* concept.
2. Why do you suppose translated programs often execute more quickly than interpreted ones?
3. (*True/False*): When an interpreted program written in language L1 runs, each of its instructions is decoded and executed by a program written in language L0.
4. Explain the importance of translation when dealing with languages at different virtual machine levels.
5. At which level does assembly language appear in the virtual machine example shown in this section?
6. What software utility permits compiled Java programs to run on almost any computer?
7. Name the four virtual machine levels named in this section, from lowest to highest.
8. Why don't programmers write applications in machine language?
9. Machine language is used at which level of the virtual machine shown in Figure 1-1?
10. Statements at the assembly language level of a virtual machine are translated into statements at which other level?

## 1.3 Data Representation

Assembly language programmers deal with data at the physical level, so they must be adept at examining memory and registers. Often, binary numbers are used to describe the contents of computer memory; at other times, decimal and hexadecimal numbers are used. You must develop

a certain fluency with number formats, so you can quickly translate numbers from one format to another.

Each numbering format, or system, has a *base*, or maximum number of symbols that can be assigned to a single digit. Table 1-2 shows the possible digits for the numbering systems used most commonly in hardware and software manuals. In the last row of the table, hexadecimal numbers use the digits 0 through 9 and continue with the letters A through F to represent decimal values 10 through 15. It is quite common to use hexadecimal numbers when showing the contents of computer memory and machine-level instructions.

### 1.3.1 Binary Integers

A computer stores instructions and data in memory as collections of electronic charges. Representing these entities with numbers requires a system geared to the concepts of *on* and *off* or *true* and *false*. *Binary numbers* are base 2 numbers, in which each binary digit (called a *bit*) is either 0 or 1. *Bits* are numbered sequentially starting at zero on the right side and increasing toward the left. The bit on the left is called the *most significant bit* (MSB), and the bit on the right is the *least significant bit* (LSB). The MSB and LSB bit numbers of a 16-bit binary number are shown in the following figure:

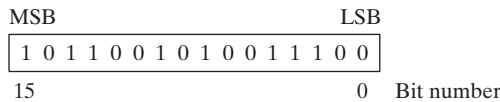


Table 1-2 Binary, Octal, Decimal, and Hexadecimal Digits.

System	Base	Possible Digits
Binary	2	0 1
Octal	8	0 1 2 3 4 5 6 7
Decimal	10	0 1 2 3 4 5 6 7 8 9
Hexadecimal	16	0 1 2 3 4 5 6 7 8 9 A B C D E F

Binary integers can be signed or unsigned. A signed integer is positive or negative. An unsigned integer is by default positive. Zero is considered positive. When writing down large binary numbers, many people like to insert a dot every 4 bits or 8 bits to make the numbers easier to read. Examples are 1101.1110.0011.1000.0000 and 11001010.10101100.

#### Unsigned Binary Integers

Starting with the LSB, each bit in an unsigned binary integer represents an increasing power of 2. The following figure contains an 8-bit binary number, showing how powers of two increase from right to left:

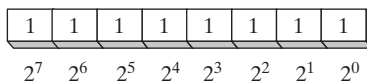


Table 1-3 lists the decimal values of  $2^0$  through  $2^{15}$ .

TABLE 1-3 Binary Bit Position Values.

$2^n$	Decimal Value	$2^n$	Decimal Value
$2^0$	1	$2^8$	256
$2^1$	2	$2^9$	512
$2^2$	4	$2^{10}$	1024
$2^3$	8	$2^{11}$	2048
$2^4$	16	$2^{12}$	4096
$2^5$	32	$2^{13}$	8192
$2^6$	64	$2^{14}$	16384
$2^7$	128	$2^{15}$	32768

**Translating Unsigned Binary Integers to Decimal**

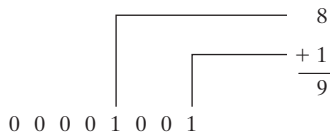
Weighted positional notation represents a convenient way to calculate the decimal value of an unsigned binary integer having  $n$  digits:

$$\text{dec} = (D_{n-1} \times 2^{n-1}) + (D_{n-2} \times 2^{n-2}) + \dots + (D_1 \times 2^1) + (D_0 \times 2^0)$$

$D$  indicates a binary digit. For example, binary 00001001 is equal to 9. We calculate this value by leaving out terms equal to zero:

$$(1 \times 2^3) + (1 \times 2^0) = 9$$

The same calculation is shown by the following figure:



**Translating Unsigned Decimal Integers to Binary**

To translate an unsigned decimal integer into binary, repeatedly divide the integer by 2, saving each remainder as a binary digit. The following table shows the steps required to translate decimal 37 to binary. The remainder digits, starting from the top row, are the binary digits  $D_0, D_1, D_2, D_3, D_4,$  and  $D_5$ :

Division	Quotient	Remainder
$37 / 2$	18	1
$18 / 2$	9	0
$9 / 2$	4	1
$4 / 2$	2	0
$2 / 2$	1	0
$1 / 2$	0	1

We can concatenate the binary bits from the remainder column of the table in reverse order ( $D_5, D_4, \dots$ ) to produce binary 100101. Because computer storage always consists of binary numbers whose lengths are multiples of 8, we fill the remaining two digit positions on the left with zeros, producing 00100101.

**Tip:** How many bits? There's a simple formula to find  $b$ , the number of binary bits you need to represent the unsigned decimal value  $n$ . It is  $b = \text{ceiling}(\log_2 n)$ . If  $n = 17$ , for example,  $\log_2 17 = 4.087463$ , which when raised to the smallest following integer, equals 5. Most calculators don't have a log base 2 operation, but you can find web pages that will calculate it for you.

### 1.3.2 Binary Addition

When adding two binary integers, proceed bit by bit, starting with the low-order pair of bits (on the right) and add each subsequent pair of bits. There are four ways to add two binary digits, as shown here:

$0 + 0 = 0$	$0 + 1 = 1$
$1 + 0 = 1$	$1 + 1 = 10$

When adding 1 to 1, the result is 10 binary (think of it as the decimal value 2). The extra digit generates a carry to the next-highest bit position. In the following figure, we add binary 00000100 to 00000111:

$$\begin{array}{r}
 \text{Carry: } 1 \\
 \begin{array}{cccccccc}
 0 & 0 & 0 & 0 & 0 & 1 & 0 & 0 \\
 + & 0 & 0 & 0 & 0 & 0 & 1 & 1 & 1 \\
 \hline
 0 & 0 & 0 & 0 & 1 & 0 & 1 & 1 & \\
 \end{array} \\
 \text{Bit position: } \quad 7 \quad 6 \quad 5 \quad 4 \quad 3 \quad 2 \quad 1 \quad 0
 \end{array}
 \tag{11}$$

Beginning with the lowest bit in each number (bit position 0), we add  $0 + 1$ , producing a 1 in the bottom row. The same happens in the next highest bit (position 1). In bit position 2, we add  $1 + 1$ , generating a sum of zero and a carry of 1. In bit position 3, we add the carry bit to  $0 + 0$ , producing 1. The rest of the bits are zeros. You can verify the addition by adding the decimal equivalents shown on the right side of the figure ( $4 + 7 = 11$ ).

Sometimes a carry is generated out of the highest bit position. When that happens, the size of the storage area set aside becomes important. If we add 11111111 to 00000001, for example, a 1 carries out of the highest bit position, and the lowest 8 bits of the sum equal all zeros. If the storage location for the sum is at least 9 bits long, we can represent the sum as 100000000. But if the sum can only store 8 bits, it will equal to 00000000, the lowest 8 bits of the calculated value.

### 1.3.3 Integer Storage Sizes

The basic storage unit for all data in an x86 computer is a *byte*, containing 8 bits. Other storage sizes are *word* (2 bytes), *doubleword* (4 bytes), and *quadword* (8 bytes). In the following figure, the number of bits is shown for each size:

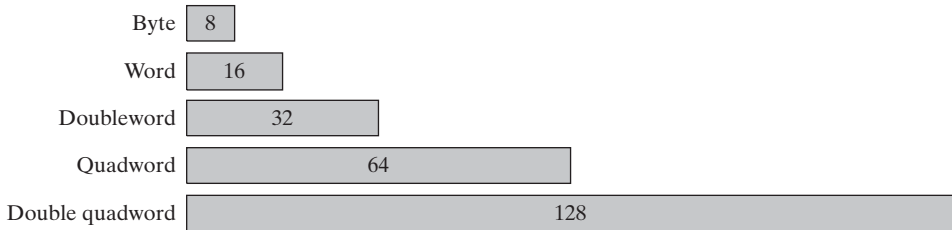


Table 1-4 shows the range of possible values for each type of unsigned integer.

**Large Measurements** A number of large measurements are used when referring to both memory and disk space:

- One *kilobyte* is equal to  $2^{10}$ , or 1024 bytes.
- One *megabyte* (1 MByte) is equal to  $2^{20}$ , or 1,048,576 bytes.
- One *gigabyte* (1 GByte) is equal to  $2^{30}$ , or  $1024^3$ , or 1,073,741,824 bytes.
- One *terabyte* (1 TByte) is equal to  $2^{40}$ , or  $1024^4$ , or 1,099,511,627,776 bytes.
- One *petabyte* is equal to  $2^{50}$ , or 1,125,899,906,842,624 bytes.
- One *exabyte* is equal to  $2^{60}$ , or 1,152,921,504,606,846,976 bytes.
- One *zettabyte* is equal to  $2^{70}$  bytes.
- One *yottabyte* is equal to  $2^{80}$  bytes.

TABLE 1-4 Ranges and Sizes of Unsigned Integer Types.

Type	Range	Storage Size in Bits
Unsigned byte	0 to $2^8 - 1$	8
Unsigned word	0 to $2^{16} - 1$	16
Unsigned doubleword	0 to $2^{32} - 1$	32
Unsigned quadword	0 to $2^{64} - 1$	64
Unsigned double quadword	0 to $2^{128} - 1$	128

### 1.3.4 Hexadecimal Integers

Large binary numbers are cumbersome to read, so hexadecimal digits offer a convenient way to represent binary data. Each digit in a hexadecimal integer represents four binary bits, and two hexadecimal digits together represent a byte. A single hexadecimal digit represents decimal 0 to 15, so letters A to F represent decimal values in the range 10 through 15. Table 1-5 shows how each sequence of four binary bits translates into a decimal or hexadecimal value.



Table 1-5 Binary, Decimal, and Hexadecimal Equivalents.

Binary	Decimal	Hexadecimal	Binary	Decimal	Hexadecimal
0000	0	0	1000	8	8
0001	1	1	1001	9	9
0010	2	2	1010	10	A
0011	3	3	1011	11	B
0100	4	4	1100	12	C
0101	5	5	1101	13	D
0110	6	6	1110	14	E
0111	7	7	1111	15	F

The following example shows how binary 0001 0110 1010 0111 1001 0100 is equivalent to hexadecimal 16A794:

1	6	A	7	9	4
0001	0110	1010	0111	1001	0100

**Converting Unsigned Hexadecimal to Decimal**

In hexadecimal, each digit position represents a power of 16. This is helpful when calculating the decimal value of a hexadecimal integer. Suppose we number the digits in a four-digit hexadecimal integer with subscripts as  $D_3D_2D_1D_0$ . The following formula calculates the integer’s decimal value:

$$dec = (D_3 \times 16^3) + (D_2 \times 16^2) + (D_1 \times 16^1) + (D_0 \times 16^0)$$

The formula can be generalized for any  $n$ -digit hexadecimal integer:

$$dec = (D_{n-1} \times 16^{n-1}) + (D_{n-2} \times 16^{n-2}) + \dots + (D_1 \times 16^1) + (D_0 \times 16^0)$$

In general, you can convert an  $n$ -digit integer in any base  $B$  to decimal using the following formula:  $dec = (D_{n-1} \times B^{n-1}) + (D_{n-2} \times B^{n-2}) + \dots + (D_1 \times B^1) + (D_0 \times B^0)$ .

For example, hexadecimal 1234 is equal to  $(1 \times 16^3) + (2 \times 16^2) + (3 \times 16^1) + (4 \times 16^0)$ , or decimal 4660. Similarly, hexadecimal 3BA4 is equal to  $(3 \times 16^3) + (11 \times 16^2) + (10 \times 16^1) + (4 \times 16^0)$ , or decimal 15,268. The following figure shows this last calculation:

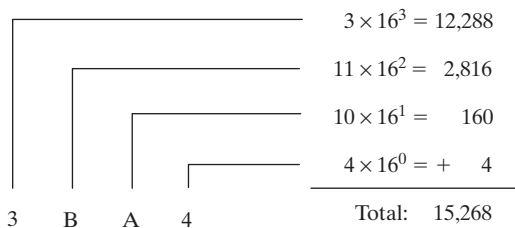


Table 1-6 lists the powers of 16 from  $16^0$  to  $16^7$ .

Table 1-6 Powers of 16 in Decimal.

$16^n$	Decimal Value	$16^n$	Decimal Value
$16^0$	1	$16^4$	65,536
$16^1$	16	$16^5$	1,048,576
$16^2$	256	$16^6$	16,777,216
$16^3$	4096	$16^7$	268,435,456

### Converting Unsigned Decimal to Hexadecimal

To convert an unsigned decimal integer to hexadecimal, repeatedly divide the decimal value by 16 and retain each remainder as a hexadecimal digit. For example, the following table lists the steps when converting decimal 422 to hexadecimal:

Division	Quotient	Remainder
$422 / 16$	26	6
$26 / 16$	1	A
$1 / 16$	0	1

The resulting hexadecimal number is assembled from the digits in the remainder column, starting from the last row and working upward to the top row. In this example, the hexadecimal representation is **1A6**. The same algorithm was used for binary integers in Section 1.3.1. To convert from decimal into some other number base other than hexadecimal, replace the divisor (16) in each calculation with the desired number base.

### 1.3.5 Hexadecimal Addition

Debugging utility programs (known as *debuggers*) usually display memory addresses in hexadecimal. It is often necessary to add two addresses in order to locate a new address. Fortunately, hexadecimal addition works the same way as decimal addition, if you just change the number base.

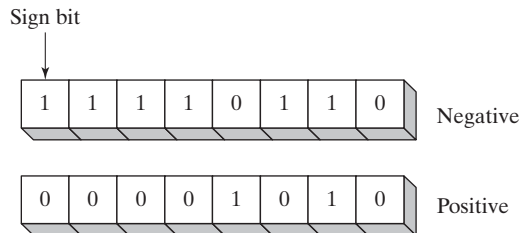
Suppose we want to add two numbers X and Y, using numbering base  $b$ . We will number their digits from the lowest position ( $x_0$ ) to the highest. If we add digits  $x_i$  and  $y_i$  in X and Y, we produce the value  $s_i$ . If  $s_i \geq b$ , we recalculate  $s_i = (s_i \text{ MOD } b)$  and generate a carry value of 1. When we move to the next pair of digits  $x_{i+1}$  and  $y_{i+1}$ , we add the carry value to their sum.

For example, let's add the hexadecimal values 6A2 and 49A. In the lowest digit position,  $2 + A =$  decimal 12, so there is no carry and we use C to indicate the hexadecimal sum digit. In the next position,  $A + 9 =$  decimal 19, so there is a carry because  $19 \geq 16$ , the number base. We calculate  $19 \text{ MOD } 16 = 3$ , and carry a 1 into the third digit position. Finally, we add  $1 + 6 + 4 =$  decimal 11, which is shown as the letter B in the third position of the sum. The hexadecimal sum is B3C.

<b>Carry</b>	1		
X	6	A	2
Y	4	9	A
S	B	3	C

### 1.3.6 Signed Binary Integers

Signed binary integers are positive or negative. For x86 processors, the MSB indicates the sign: 0 is positive and 1 is negative. The following figure shows examples of 8-bit negative and positive integers:



### Two's-Complement Representation

Negative integers use *two's-complement* representation, using the mathematical principle that the two's complement of an integer is its additive inverse. (If you add a number to its additive inverse, the sum is zero.)

Two's-complement representation is useful to processor designers because it removes the need for separate digital circuits to handle both addition and subtraction. For example, if presented with the expression  $A - B$ , the processor can simply convert it to an addition expression:  $A + (-B)$ .

The two's complement of a binary integer is formed by inverting (complementing) its bits and adding 1. Using the 8-bit binary value 00000001, for example, its two's complement turns out to be 11111111, as can be seen as follows:

Starting value	00000001
Step 1: Reverse the bits	11111110
Step 2: Add 1 to the value from Step 1	11111110 +00000001
Sum: Two's-complement representation	11111111

11111111 is the two's-complement representation of  $-1$ . The two's-complement operation is reversible, so the two's complement of 11111111 is 00000001.

**Hexadecimal Two's Complement** To create the two's complement of a hexadecimal integer, reverse all bits and add 1. An easy way to reverse the bits of a hexadecimal digit is to subtract the digit from 15. Here are examples of hexadecimal integers converted to their two's complements:

$$\begin{aligned}
 6A3D & \text{ --> } 95C2 + 1 \text{ --> } 95C3 \\
 95C3 & \text{ --> } 6A3C + 1 \text{ --> } 6A3D
 \end{aligned}$$

**Converting Signed Binary to Decimal** Use the following algorithm to calculate the decimal equivalent of a signed binary integer:

- If the highest bit is a 1, the number is stored in two's-complement notation. Create its two's complement a second time to get its positive equivalent. Then convert this new number to decimal as if it were an unsigned binary integer.
- If the highest bit is a 0, you can convert it to decimal as if it were an unsigned binary integer.

For example, signed binary 11110000 has a 1 in the highest bit, indicating that it is a negative integer. First we create its two's complement, and then convert the result to decimal. Here are the steps in the process:

Starting value	11110000
Step 1: Reverse the bits	00001111
Step 2: Add 1 to the value from Step 1	$\begin{array}{r} 00001111 \\ + \phantom{0000}1 \\ \hline \end{array}$
Step 3: Create the two's complement	00010000
Step 4: Convert to decimal	16

Because the original integer (11110000) was negative, we know that its decimal value is  $-16$ .

**Converting Signed Decimal to Binary** To create the binary representation of a signed decimal integer, do the following:

1. Convert the absolute value of the decimal integer to binary.
2. If the original decimal integer was negative, create the two's complement of the binary number from the previous step.

For example,  $-43$  decimal is translated to binary as follows:

1. The binary representation of unsigned 43 is 00101011.
2. Because the original value was negative, we create the two's complement of 00101011, which is 11010101. This is the representation of  $-43$  decimal.

**Converting Signed Decimal to Hexadecimal** To convert a signed decimal integer to hexadecimal, do the following:

1. Convert the absolute value of the decimal integer to hexadecimal.
2. If the decimal integer was negative, create the two's complement of the hexadecimal number from the previous step.

**Converting Signed Hexadecimal to Decimal** To convert a signed hexadecimal integer to decimal, do the following:

1. If the hexadecimal integer is negative, create its two's complement; otherwise, retain the integer as is.
2. Using the integer from the previous step, convert it to decimal. If the original value was negative, attach a minus sign to the beginning of the decimal integer.

You can tell whether a hexadecimal integer is positive or negative by inspecting its most significant (highest) digit. If the digit is  $\geq 8$ , the number is negative; if the digit is  $\leq 7$ , the number is positive. For example, hexadecimal 8A20 is negative and 7FD9 is positive.

### Maximum and Minimum Values

A signed integer of  $n$  bits uses only  $n - 1$  bits to represent the number's magnitude. Table 1-7 shows the minimum and maximum values for signed bytes, words, doublewords, and quadwords.

TABLE 1-7 Ranges and Sizes of Signed Integer Types.

Type	Range	Storage Size in Bits
Signed byte	$-2^7$ to $+2^7 - 1$	8
Signed word	$-2^{15}$ to $+2^{15} - 1$	16
Signed doubleword	$-2^{31}$ to $+2^{31} - 1$	32
Signed quadword	$-2^{63}$ to $+2^{63} - 1$	64
Signed double quadword	$-2^{127}$ to $+2^{127} - 1$	128

### 1.3.7 Binary Subtraction

Subtracting a smaller unsigned binary number from a large one is easy if you go about it in the same way you handle decimal subtraction. Here's an example:

$$\begin{array}{r}
 0\ 1\ 1\ 0\ 1 \quad (\text{decimal } 13) \\
 - 0\ 0\ 1\ 1\ 1 \quad (\text{decimal } 7) \\
 \hline
 \end{array}$$

Subtracting the bits in position 0 is straightforward:

$$\begin{array}{r}
 0\ 1\ 1\ 0\ 1 \\
 - 0\ 0\ 1\ 1\ 1 \\
 \hline
 0
 \end{array}$$

In the next position ( $0 - 1$ ), we are forced to borrow a 1 from the next position to the left. Here's the result of subtracting 1 from 2:

$$\begin{array}{r}
 0\ 1\ 0\ 0\ 1 \\
 - 0\ 0\ 1\ 1\ 1 \\
 \hline
 1\ 0
 \end{array}$$

In the next bit position, we again have to borrow a bit from the column just to the left and subtract 1 from 2:

$$\begin{array}{r}
 0\ 0\ 0\ 1\ 1 \\
 - 0\ 0\ 1\ 1\ 1 \\
 \hline
 1\ 1\ 0
 \end{array}$$

Finally, the two high-order bits are zero minus zero:

$$\begin{array}{r}
 0\ 0\ 0\ 1\ 1 \\
 - 0\ 0\ 1\ 1\ 1 \\
 \hline
 0\ 0\ 1\ 1\ 0 \quad (\text{decimal } 6)
 \end{array}$$

A simpler way to approach binary subtraction is to reverse the sign of the value being subtracted, and then add the two values. This method requires you to have an extra empty bit to hold the number's sign. Let's try it with the same problem we just calculated: (01101 minus 00111). First, we negate 00111 by inverting its bits (11000) and adding 1, producing 11001. Next, we add the binary values and ignore the carry out of the highest bit:

$$\begin{array}{r}
 0\ 1\ 1\ 0\ 1 \quad (+13) \\
 1\ 1\ 0\ 0\ 1 \quad (-7) \\
 \hline
 0\ 0\ 1\ 1\ 0 \quad (+6)
 \end{array}$$

The result, +6, is exactly what we expected.

### 1.3.8 Character Storage

If computers only store binary data, how do they represent characters? They use a *character set*, which is a mapping of characters to integers. In earlier times, character sets used only 8 bits. Even now, when running in character mode (such as MS-DOS), IBM-compatible microcomputers use the *ASCII* (pronounced “askey”) character set. ASCII is an acronym for *American Standard Code for Information Interchange*. In ASCII, a unique 7-bit integer is assigned to each character. Because ASCII codes use only the lower 7 bits of every byte, the extra bit is used on various computers to create a proprietary character set. On IBM-compatible microcomputers, for example, values 128 through 255 represent graphic symbols and Greek characters.

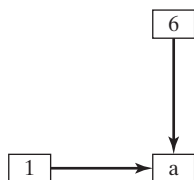
**ANSI Character Set** The American National Standards Institute (ANSI) defines an 8-bit character set that represents up to 256 characters. The first 128 characters correspond to the letters and symbols on a standard U.S. keyboard. The second 128 characters represent special characters such as letters in international alphabets, accents, currency symbols, and fractions. Early version of Microsoft Windows used the ANSI character set.

**Unicode Standard** Today, computers must be able to represent a wide variety of international languages in computer software. As a result, the *Unicode* standard was created as a universal way of defining characters and symbols. It defines numeric codes (called *code points*) for characters, symbols, and punctuation used in all major languages, as well as European alphabetic scripts, Middle Eastern right-to-left scripts, and many scripts of Asia. Three transformation formats are used to transform code points into displayable characters:

- **UTF-8** is used in HTML, and has the same byte values as ASCII.
- **UTF-16** is used in environments that balance efficient access to characters with economical use of storage. Recent versions of Microsoft Windows, for example, use UTF-16 encoding. Each character is encoded in 16 bits.
- **UTF-32** is used in environments where space is no concern and fixed-width characters are required. Each character is encoded in 32 bits.

**ASCII Strings** A sequence of one or more characters is called a *string*. More specifically, an *ASCII string* is stored in memory as a succession of bytes containing ASCII codes. For example, the numeric codes for the string “ABC123” are 41h, 42h, 43h, 31h, 32h, and 33h. A *null-terminated* string is a string of characters followed by a single byte containing zero. The C and C++ languages use null-terminated strings, and many Windows operating system functions require strings to be in this format.

**Using the ASCII Table** A table on the inside back cover of this book lists ASCII codes used when running in Windows Console mode. To find the hexadecimal ASCII code of a character, look along the top row of the table and find the column containing the character you want to translate. The most significant digit of the hexadecimal value is in the second row at the top of the table; the least significant digit is in the second column from the left. For example, to find the ASCII code of the letter **a**, find the column containing the **a** and look in the second row: The first hexadecimal digit is 6. Next, look to the left along the row containing **a** and note that the second column contains the digit 1. Therefore, the ASCII code of **a** is 61 hexadecimal. This is shown as follows in simplified form:



**ASCII Control Characters** Character codes in the range 0 through 31 are called *ASCII control characters*. If a program writes these codes to standard output (as in C++), the control characters will carry out predefined actions. Table 1-8 lists the most commonly used characters in this range, and a complete list may be found in the inside front cover of this book.

TABLE 1-8 ASCII Control Characters.

ASCII Code (Decimal)	Description
8	Backspace (moves one column to the left)
9	Horizontal tab (skips forward <i>n</i> columns)
10	Line feed (moves to next output line)
12	Form feed (moves to next printer page)
13	Carriage return (moves to leftmost output column)
27	Escape character

**Terminology for Numeric Data Representation** It is important to use precise terminology when describing the way numbers and characters are represented in memory and on the display screen. Decimal 65, for example, is stored in memory as a single binary byte as 01000001. A debugging program would probably display the byte as “41,” which is the number’s hexadecimal representation. If the byte were copied to video memory, the letter “A” would appear on the screen because 01000001 is the ASCII code for the letter **A**. Because a number’s interpretation can depend on the context in which it appears, we assign a specific name to each type of data representation to clarify future discussions:

- A *binary integer* is an integer stored in memory in its raw format, ready to be used in a calculation. Binary integers are stored in multiples of 8 bits (such as 8, 16, 32, or 64).

- A *digit string* is a string of ASCII characters, such as “123” or “65.” This is simply a representation of the number and can be in any of the formats shown for the decimal number 65 in Table 1-9:

Table 1-9 Types of Digit Strings.

Format	Value
Binary digit string	“01000001”
Decimal digit string	“65”
Hexadecimal digit string	“41”
Octal digit string	“101”

### 1.3.9 Section Review

1. Explain the term *least significant bit* (LSB).
2. What is the decimal representation of each of the following unsigned binary integers?
  - a. 11111000
  - b. 11001010
  - c. 11110000
3. What is the sum of each pair of binary integers?
  - a. 00001111 + 00000010
  - b. 11010101 + 01101011
  - c. 00001111 + 00001111
4. How many bytes are contained in each of the following data types?
  - a. word
  - b. doubleword
  - c. quadword
  - d. double quadword
5. What is the minimum number of binary bits needed to represent each of the following unsigned decimal integers?
  - a. 65
  - b. 409
  - c. 16385
6. What is the hexadecimal representation of each of the following binary numbers?
  - a. 0011 0101 1101 1010
  - b. 1100 1110 1010 0011
  - c. 1111 1110 1101 1011
7. What is the binary representation of the following hexadecimal numbers?
  - a. A4693FBC
  - b. B697C7A1
  - c. 2B3D9461



## 1.4 Boolean Expressions

*Boolean algebra* defines a set of operations on the values **true** and **false**. It was invented by George Boole, a mid-nineteenth-century mathematician. When early digital computers were invented, it was found that Boole's algebra could be used to describe the design of digital circuits. At the same time, boolean expressions are used in computer programs to express logical operations.

A *boolean expression* involves a boolean operator and one or more operands. Each boolean expression implies a value of true or false. The set of operators includes the following:

- NOT: notated as  $\neg$  or  $\sim$  or ' '
- AND: notated as  $\wedge$  or  $\bullet$
- OR: notated as  $\vee$  or  $+$

The NOT operator is unary, and the other operators are binary. The operands of a boolean expression can also be boolean expressions. The following are examples:

Expression	Description
$\neg X$	NOT X
$X \wedge Y$	X AND Y
$X \vee Y$	X OR Y
$\neg X \vee Y$	(NOT X) OR Y
$\neg(X \wedge Y)$	NOT (X AND Y)
$X \wedge \neg Y$	X AND (NOT Y)

**NOT** The NOT operation reverses a boolean value. It can be written in mathematical notation as  $\neg X$ , where X is a variable (or expression) holding a value of true (T) or false (F). The following truth table shows all the possible outcomes of NOT using a variable **X**. Inputs are on the left side and outputs (shaded) are on the right side:

X	$\neg X$
F	T
T	F

A truth table can use 0 for false and 1 for true.

**AND** The Boolean AND operation requires two operands, and can be expressed using the notation  $X \wedge Y$ . The following truth table shows all the possible outcomes (shaded) for the values of X and Y:

X	Y	$X \wedge Y$
F	F	F
F	T	F
T	F	F
T	T	T

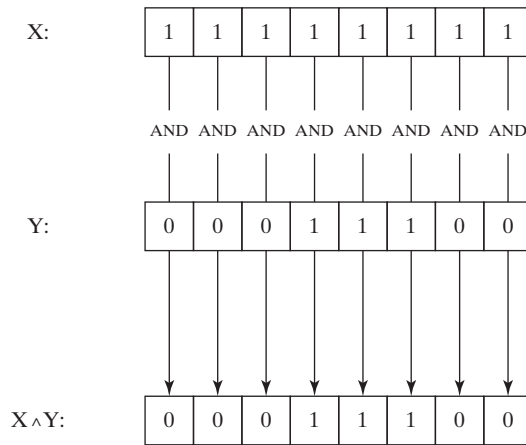
The output is true only when both inputs are true. This corresponds to the logical AND used in compound boolean expressions in C++ and Java.

The AND operation is often carried out at the bit level in assembly language. In the following example, each bit in X is ANDed with its corresponding bit in Y:

```
X:      11111111
Y:      00011100
X ^ Y:  00011100
```

As Figure 1-2 shows, each bit of the resulting value, 00011100, represents the result of ANDing the corresponding bits in X and Y.

FIGURE 1-2 ANDING the bits of two binary integers.



**OR** The Boolean OR operation requires two operands, and is often expressed using the notation  $X \vee Y$ . The following truth table shows all the possible outcomes (shaded) for the values of X and Y:

X	Y	$X \vee Y$
F	F	F
F	T	T
T	F	T
T	T	T

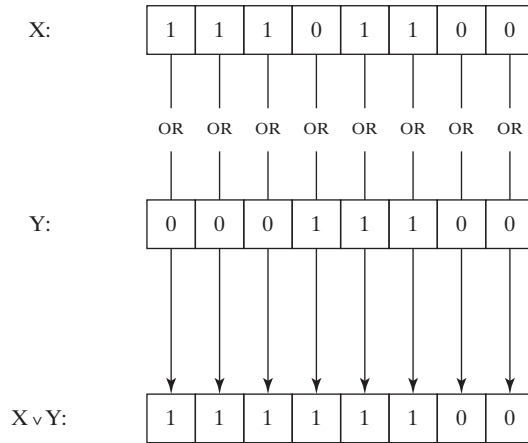
The output is false only when both inputs are false. This truth table corresponds to the logical OR used in compound boolean expressions in C++ and Java.

The OR operation is often carried out at the bit level. In the following example, each bit in X is ORed with its corresponding bit in Y, producing 11111100:

```
X:      11101100
Y:      00011100
X v Y:  11111100
```

As shown in Figure 1-3, the bits are ORed individually, producing a corresponding bit in the result.

FIGURE 1-3 ORing the bits in two binary integers.



**Operator Precedence** *Operator precedence rules* are used to indicate which operators execute first in expressions involving multiple operators. In a boolean expression involving more than one operator, precedence is important. As shown in the following table, the NOT operator has the highest precedence, followed by AND and OR. You can use parentheses to force the initial evaluation of an expression:

Expression	Order of Operations
$\neg X \vee Y$	NOT, then OR
$\neg(X \vee Y)$	OR, then NOT
$X \vee (Y \wedge Z)$	AND, then OR

### 1.4.1 Truth Tables for Boolean Functions

A *boolean function* receives boolean inputs and produces a boolean output. A truth table can be constructed for any boolean function, showing all possible inputs and outputs. The following are truth tables representing boolean functions having two inputs named X and Y. The shaded column on the right is the function's output:

**Example 1:**  $\neg X \vee Y$ 

<b>X</b>	<b><math>\neg X</math></b>	<b>Y</b>	<b><math>\neg X \vee Y</math></b>
F	T	F	T
F	T	T	T
T	F	F	F
T	F	T	T

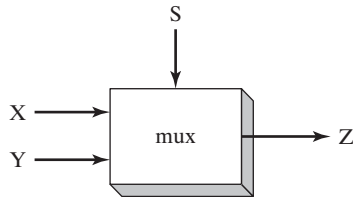
**Example 2:**  $X \wedge \neg Y$ 

<b>X</b>	<b>Y</b>	<b><math>\neg Y</math></b>	<b><math>X \wedge \neg Y</math></b>
F	F	T	F
F	T	F	F
T	F	T	T
T	T	F	F

**Example 3:**  $(Y \wedge S) \vee (X \wedge \neg S)$ 

<b>X</b>	<b>Y</b>	<b>S</b>	<b><math>Y \wedge S</math></b>	<b><math>\neg S</math></b>	<b><math>X \wedge \neg S</math></b>	<b><math>(Y \wedge S) \vee (X \wedge \neg S)</math></b>
F	F	F	F	T	F	F
F	T	F	F	T	F	F
T	F	F	F	T	T	T
T	T	F	F	T	T	T
F	F	T	F	F	F	F
F	T	T	T	F	F	T
T	F	T	F	F	F	F
T	T	T	T	F	F	T

The boolean function in Example 3 describes a *multiplexer*, a digital component that uses a selector bit (S) to select one of two outputs (X or Y). If S = false, the function output (Z) is the same as X. If S = true, the function output is the same as Y. Here is a block diagram of a multiplexer:



### 1.4.2 Section Review

1. Describe the following boolean expression:  $\neg X \vee Y$ .
2. Describe the following boolean expression:  $(X \wedge Y)$ .
3. What is the value of the boolean expression  $(T \wedge F) \vee T$  ?
4. What is the value of the boolean expression  $\neg(F \vee T)$  ?
5. What is the value of the boolean expression  $\neg F \vee \neg T$  ?

## 1.5 Chapter Summary

This book focuses on programming x86 processors, using the MS-Windows platform. We cover basic principles about computer architecture, machine language, and low-level programming. You will learn enough assembly language to test your knowledge on today's most widely used microprocessor family.

Before reading this book, you should have completed a single college course or equivalent in computer programming.

An *assembler* is a program that converts source-code programs from assembly language into machine language. A companion program, called a linker, combines individual files created by an assembler into a single executable program. A third program, called a debugger, provides a way for a programmer to trace the execution of a program and examine the contents of memory.

You will create 32-bit and 64-bit programs for the most part, and 16-bit programs if you focus on the last four chapters.

You will learn the following concepts from this book: basic computer architecture applied to x86 (and Intel 64) processors; elementary boolean logic; how x86 processors manage memory; how high-level language compilers translate statements from their language into assembly language and native machine code; how high-level languages implement arithmetic expressions, loops, and logical structures at the machine level; and the data representation of signed and unsigned integers, real numbers, and character data.

Assembly language has a *one-to-one* relationship with machine language, in which a single assembly language instruction corresponds to one machine language instruction. Assembly language is not portable because it is tied to a specific processor family.

Programming languages are tools that you can use to create individual applications or parts of applications. Some applications, such as device drivers and hardware interface routines, are more suited to assembly language. Other applications, such as multiplatform commercial and scientific applications, are more easily written in high-level languages.

The *virtual machine* concept is an effective way of showing how each layer in a computer architecture represents an abstraction of a machine. Layers can be constructed of hardware or software, and programs written at any layer can be translated or interpreted by the next-lowest layer. The virtual machine concept can be related to real-world computer layers, including digital logic, instruction set architecture, assembly language, and high-level languages.

Binary and hexadecimal numbers are essential notational tools for programmers working at the machine level. For this reason, you must understand how to manipulate and translate between number systems and how character representations are created by computers.

The following boolean operators were presented in this chapter: NOT, AND, and OR. A boolean expression combines a boolean operator with one or more operands. A truth table is an effective way to show all possible inputs and outputs of a boolean function.

## 1.6 Key Terms

ASCII	high-level language
ASCII control characters	instruction set architecture (ISA)
ASCII digit string	Java Native Interface (JNI)
assembler	kilobyte
assembly language	language portability
binary digit string	least significant bit (LSB)
binary integer	machine language
bit	megabyte
boolean algebra	microcode interpreter
boolean expression	microprogram
boolean function	Microsoft Macro Assembler (MASM)
character set	most significant bit (MSB)
code interpretation	multiplexer
code point (Unicode)	null-terminated string
code translation	octal digit string
debugger	one-to-many relationship
device driver	operator precedence
digit string	petabyte
embedded systems application	registers
exabyte	signed binary integer
gigabyte	terabyte
hexadecimal digit string	Unicode
hexadecimal integer	Unicode Transformation Format (UTF)

unsigned binary integer	virtual machine concept
UTF-8	Visual Studio
UTF-16	yottabyte
UTF-32	zettabyte
virtual machine (VM)	

## 1.7 Review Questions and Exercises

### 1.7.1 Short Answer

- In an 8-bit binary number, which is the most significant bit (MSB)?
- What is the decimal representation of each of the following unsigned binary integers?
  - 00110101
  - 10010110
  - 11001100
- What is the sum of each pair of binary integers?
  - 10101111 + 11011011
  - 10010111 + 11111111
  - 01110101 + 10101100
- Calculate binary 00001101 minus 00000111.
- How many bits are used by each of the following data types?
  - word
  - doubleword
  - quadword
  - double quadword
- What is the minimum number of binary bits needed to represent each of the following unsigned decimal integers?
  - 4095
  - 65534
  - 42319
- What is the hexadecimal representation of each of the following binary numbers?
  - 0011 0101 1101 1010
  - 1100 1110 1010 0011
  - 1111 1110 1101 1011
- What is the binary representation of the following hexadecimal numbers?
  - 0126F9D4
  - 6ACDFA95
  - F69BDC2A
- What is the unsigned decimal representation of each of the following hexadecimal integers?
  - 3A
  - 1BF
  - 1001

10. What is the unsigned decimal representation of each of the following hexadecimal integers?
  - a. 62
  - b. 4B3
  - c. 29F
11. What is the 16-bit hexadecimal representation of each of the following signed decimal integers?
  - a. -24
  - b. -331
12. What is the 16-bit hexadecimal representation of each of the following signed decimal integers?
  - a. -21
  - b. -45
13. The following 16-bit hexadecimal numbers represent signed integers. Convert each to decimal.
  - a. 6BF9
  - b. C123
14. The following 16-bit hexadecimal numbers represent signed integers. Convert each to decimal.
  - a. 4CD2
  - b. 8230
15. What is the decimal representation of each of the following signed binary numbers?
  - a. 10110101
  - b. 00101010
  - c. 11110000
16. What is the decimal representation of each of the following signed binary numbers?
  - a. 10000000
  - b. 11001100
  - c. 10110111
17. What is the 8-bit binary (two's-complement) representation of each of the following signed decimal integers?
  - a. -5
  - b. -42
  - c. -16
18. What is the 8-bit binary (two's-complement) representation of each of the following signed decimal integers?
  - a. -72
  - b. -98
  - c. -26
19. What is the sum of each pair of hexadecimal integers?
  - a. 6B4 + 3FE
  - b. A49 + 6BD



20. What is the sum of each pair of hexadecimal integers?
  - a.  $7C4 + 3BE$
  - b.  $B69 + 7AD$
21. What are the hexadecimal and decimal representations of the ASCII character capital B?
22. What are the hexadecimal and decimal representations of the ASCII character capital G?
23. *Challenge:* What is the largest decimal value you can represent, using a 129-bit unsigned integer?
24. *Challenge:* What is the largest decimal value you can represent, using a 86-bit signed integer?
25. Create a truth table to show all possible inputs and outputs for the boolean function described by  $\neg(A \vee B)$ .
26. Create a truth table to show all possible inputs and outputs for the boolean function described by  $(\neg A \wedge \neg B)$ . How would you describe the rightmost column of this table in relation to the table from question number 25? Have you heard of *De Morgan's Theorem*?
27. If a boolean function has four inputs, how many rows are required for its truth table?
28. How many selector bits are required for a four-input multiplexer?

### 1.7.2 Algorithm Workbench

Use any high-level programming language you wish for the following programming exercises. Do not call built-in library functions that accomplish these tasks automatically. (Examples are `sprintf` and `scanf` from the Standard C library.)

1. Write a function that receives a string containing a 16-bit binary integer. The function must return the string's integer value.
2. Write a function that receives a string containing a 32-bit hexadecimal integer. The function must return the string's integer value.
3. Write a function that receives an integer. The function must return a string containing the binary representation of the integer.
4. Write a function that receives an integer. The function must return a string containing the hexadecimal representation of the integer.
5. Write a function that adds two digit strings in base  $b$ , where  $2 \leq b \leq 10$ . Each string may contain as many as 1,000 digits. Return the sum in a string that uses the same number base.
6. Write a function that adds two hexadecimal strings, each as long as 1,000 digits. Return a hexadecimal string that represents the sum of the inputs.
7. Write a function that multiplies a single hexadecimal digit by a hexadecimal digit string as long as 1,000 digits. Return a hexadecimal string that represents the product.

- Write a Java program that contains the calculation shown below. Then, use the `javap -c` command to disassemble your code. Add comments to each line that provide your best guess as to its purpose.

```
int Y;  
int X = (Y + 4) * 3;
```

- Devisе a way of subtracting unsigned binary integers. Test your technique by subtracting binary 00000101 from binary 10001000, producing 10000011. Test your technique with at least two other sets of integers, in which a smaller value is always subtracted from a larger one.

### Chapter End Notes

- Donald Knuth, MMIX, *A RISC Computer for the New Millennium*, Transcript of a lecture given at the Massachusetts Institute of Technology, December 30, 1999.

---

# x86 PROCESSOR ARCHITECTURE

- 2.1 **General Concepts**
  - 2.1.1 Basic Microcomputer Design
  - 2.1.2 Instruction Execution Cycle
  - 2.1.3 Reading from Memory
  - 2.1.4 Loading and Executing a Program
  - 2.1.5 Section Review
- 2.2 **32-Bit x86 Processors**
  - 2.2.1 Modes of Operation
  - 2.2.2 Basic Execution Environment
  - 2.2.3 x86 Memory Management
  - 2.2.4 Section Review
- 2.3 **64-Bit x86-64 Processors**
  - 2.3.1 64-Bit Operation Modes
  - 2.3.2 Basic 64-Bit Execution Environment
- 2.4 **Components of a Typical x86 Computer**
  - 2.4.1 Motherboard
  - 2.4.2 Memory
  - 2.4.3 Section Review
- 2.5 **Input-Output System**
  - 2.5.1 Levels of I/O Access
  - 2.5.2 Section Review
- 2.6 **Chapter Summary**
- 2.7 **Key Terms**
- 2.8 **Review Questions**

This chapter focuses on the underlying hardware associated with x86 assembly language. It may be said that assembly language is the ideal software tool for communicating directly with a machine. If that is true, then assembly programmers must be intimately familiar with the processor's internal architecture and capabilities. We will discuss some of the basic operations that take place inside the processor when instructions are executed. We will talk about how programs are loaded and executed by the operating system. A sample motherboard layout will give some insight into the hardware environment of x86 systems, and the chapter ends with a discussion of how layered input/output works between application programs and operating systems. All of the topics in this chapter provide the hardware foundation for you to begin writing assembly language programs.

## 2.1 General Concepts

This chapter describes the architecture of the x86 processor family and its host computer system from a programmer's point of view. Included in this group are all Intel IA-32 and Intel 64 processors, such as the Intel Pentium and Core-Duo, as well as the Advanced Micro Devices (AMD) processors, such as Athlon, Phenom, Opteron, and AMD64. Assembly language is a great tool for learning how a computer works, and it requires you to have a working knowledge of computer hardware. To that end, the concepts and details in this chapter will help you to understand the assembly language code you write.

We strike a balance between concepts applying to all microcomputer systems and specifics about x86 processors. You may work on various processors in the future, so we expose you to broad concepts. To avoid giving you a superficial understanding of machine architecture, we focus on specifics of the x86, which will give you a solid grounding when programming in assembly language.

If you want to learn more about the Intel IA-32 architecture, read *the Intel 64 and IA-32 Architectures Software Developer's Manual, Volume 1: Basic Architecture*. It's a free download from the Intel web site ([www.intel.com](http://www.intel.com)).

### 2.1.1 Basic Microcomputer Design

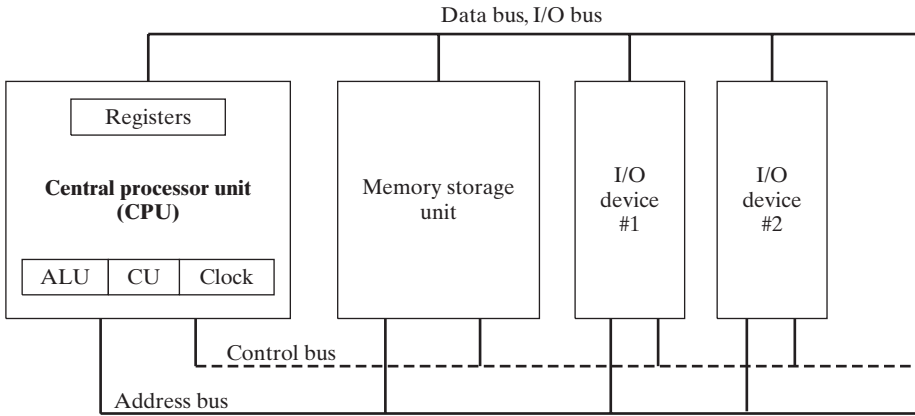
Figure 2-1 shows the basic design of a hypothetical microcomputer. The *central processor unit* (CPU), where calculations and logical operations take place, contains a limited number of storage locations named *registers*, a high-frequency clock, a control unit, and an arithmetic logic unit.

- The *clock* synchronizes the internal operations of the CPU with other system components.
- The *control unit* (CU) coordinates the sequencing of steps involved in executing machine instructions.
- The *arithmetic logic unit* (ALU) performs arithmetic operations such as addition and subtraction and logical operations such as AND, OR, and NOT.

The CPU is attached to the rest of the computer via pins attached to the CPU socket in the computer's motherboard. Most pins connect to the data bus, the control bus, and the address bus. The *memory storage unit* is where instructions and data are held while a computer program is running. The storage unit receives requests for data from the CPU, transfers data from random access memory (RAM) to the CPU, and transfers data from the CPU into memory. All processing of data takes place within the CPU, so programs residing in memory must be copied into the CPU before they can execute. Individual program instructions can be copied into the CPU one at a time, or groups of instructions can be copied together.

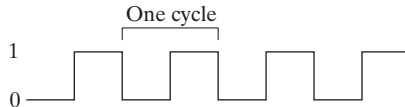
A *bus* is a group of parallel wires that transfer data from one part of the computer to another. A computer system usually contains four bus types: data, I/O, control, and address. The *data bus* transfers instructions and data between the CPU and memory. The *I/O bus* transfers data

FIGURE 2-1 Block diagram of a microcomputer.



between the CPU and the system input/output devices. The *control bus* uses binary signals to synchronize actions of all devices attached to the system bus. The *address bus* holds the addresses of instructions and data when the currently executing instruction transfers data between the CPU and memory.

**Clock** Each operation involving the CPU and the system bus is synchronized by an internal clock pulsing at a constant rate. The basic unit of time for machine instructions is a *machine cycle* (or *clock cycle*). The length of a clock cycle is the time required for one complete clock pulse. In the following figure, a clock cycle is depicted as the time between one falling edge and the next:



The duration of a clock cycle is calculated as the reciprocal of the clock’s speed, which in turn is measured in oscillations per second. A clock that oscillates 1 billion times per second (1 GHz), for example, produces a clock cycle with a duration of one billionth of a second (1 nanosecond).

A machine instruction requires at least one clock cycle to execute, and a few require in excess of 50 clocks (the multiply instruction on the 8088 processor, for example). Instructions requiring memory access often have empty clock cycles called *wait states* because of the differences in the speeds of the CPU, the system bus, and memory circuits.

**2.1.2 Instruction Execution Cycle**

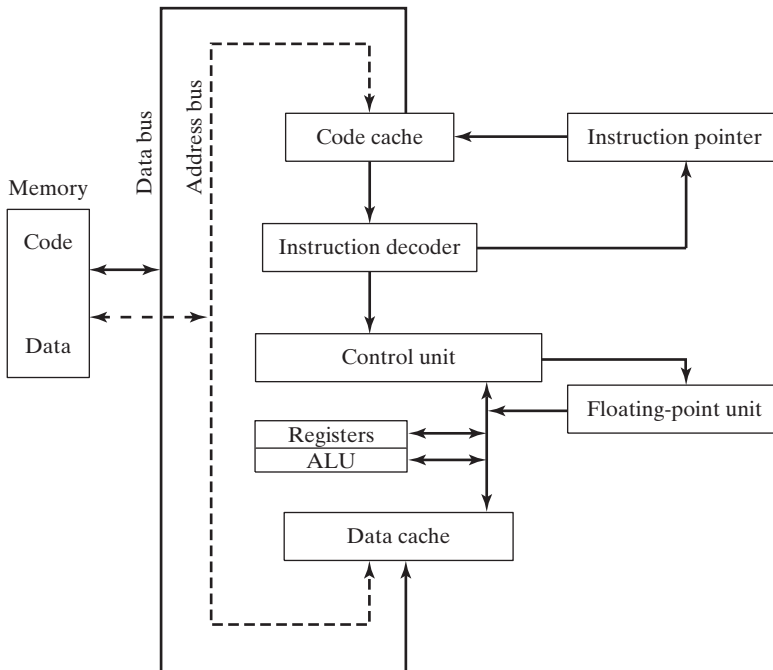
A single machine instruction does not just magically execute all at once. The CPU has to go through a predefined sequence of steps to execute a machine instruction, called the *instruction execution cycle*. Let’s assume that the instruction pointer register holds the address of the instruction we want to execute. Here are the steps to execute it:

1. First, the CPU has to **fetch the instruction** from an area of memory called the *instruction queue*. Right after doing this, it increments the instruction pointer.
2. Next, the CPU **decodes** the instruction by looking at its binary bit pattern. This bit pattern might reveal that the instruction has operands (input values).
3. If operands are involved, the CPU **fetches the operands** from registers and memory. Sometimes, this involves address calculations.
4. Next, the CPU **executes** the instruction, using any operand values it fetched during the earlier step. It also updates a few status flags, such as Zero, Carry, and Overflow.
5. Finally, if an output operand was part of the instruction, the CPU **stores the result** of its execution in the operand.

We usually simplify this complicated-sounding process to three basic steps: **Fetch**, **Decode**, and **Execute**. An *operand* is a value that is either an input or an output to an operation. For example, the expression  $Z = X + Y$  has two input operands ( $X$  and  $Y$ ) and a single output operand ( $Z$ ).

A block diagram showing data flow within a typical CPU is shown in Figure 2-2. The diagram helps to show relationships between components that interact during the instruction execution cycle. In order to read program instructions from memory, an address is placed on the address bus. Next, the memory controller places the requested code on the data bus, making the code available inside the code cache. The instruction pointer's value determines which instruction will be executed next. The instruction is analyzed by the instruction decoder, causing the appropriate

FIGURE 2-2 Simplified CPU block diagram.



digital signals to be sent to the control unit, which coordinates the ALU and floating-point unit. Although the control bus is not shown in this figure, it carries signals that use the system clock to coordinate the transfer of data between the different CPU components.

### 2.1.3 Reading from Memory

As a rule, computers read memory much more slowly than they access internal registers. This is because reading a single value from memory involves four separate steps:

1. Place the address of the value you want to read on the address bus.
2. Assert (change the value of) the processor's RD (*read*) pin.
3. Wait one clock cycle for the memory chips to respond.
4. Copy the data from the data bus into the destination operand.

Each of these steps generally requires a single *clock cycle*, a measurement of time based on a clock that ticks inside the processor at a regular rate. Computer CPUs are often described in terms of their clock speeds. A speed of *1.2 GHz*, for example, means the clock ticks, or oscillates, 1.2 billion times per second. So, 4 clock cycles go by fairly fast, considering each one lasts for only 1/1,200,000,000<sup>th</sup> of a second. Still, that's much slower than the CPU registers, which are usually accessed in only one clock cycle.

Fortunately, CPU designers figured out a long time ago that computer memory creates a speed bottleneck because most programs have to access variables. They came up with a clever way to reduce the amount of time spent reading and writing memory—they store the most recently used instructions and data in high-speed memory called *cache*. The idea is that a program is more likely to want to access the same memory and instructions repeatedly, so cache keeps these values where they can be accessed quickly. Also, when the CPU begins to execute a program, it can look ahead and load the next thousand instructions (for example) into cache, on the assumption that these instructions will be needed fairly soon. If there happens to be a loop in that block of code, the same instructions will be in cache. When the processor is able to find its data in cache memory, we call that a *cache hit*. On the other hand, if the CPU tries to find something in cache and it's not there, we call that a *cache miss*.

Cache memory for the x86 family comes in two types. *Level-1 cache* (or *primary cache*) is stored right on the CPU. *Level-2 cache* (or *secondary cache*) is a little bit slower, and attached to the CPU by a high-speed data bus. The two types of cache work together in an optimal way.

There's a reason why cache memory is faster than conventional RAM—it's because cache memory is constructed from a special type of memory chip called *static RAM*. It's expensive, but it does not have to be constantly refreshed in order to keep its contents. On the other hand, conventional memory, known as *dynamic RAM*, must be refreshed constantly. It's much slower, but cheaper.

### 2.1.4 Loading and Executing a Program

Before a program can run, it must be loaded into memory by a utility known as a *program loader*. After loading, the operating system must point the CPU to the program's *entry point*, which is the address at which the program is to begin execution. The following steps break this process down in more detail:

- The operating system (OS) searches for the program's filename in the current disk directory. If it cannot find the name there, it searches a predetermined list of directories (called *paths*) for the filename. If the OS fails to find the program filename, it issues an error message.
- If the program file is found, the OS retrieves basic information about the program's file from the disk directory, including the file size and its physical location on the disk drive.
- The OS determines the next available location in memory and loads the program file into memory. It allocates a block of memory to the program and enters information about the program's size and location into a table (sometimes called a *descriptor table*). Additionally, the OS may adjust the values of pointers within the program so they contain addresses of program data.
- The OS begins execution of the program's first machine instruction (its entry point). As soon as the program begins running, it is called a *process*. The OS assigns the process an identification number (*process ID*), which is used to keep track of it while running.
- The *process* runs by itself. It is the OS's job to track the execution of the process and to respond to requests for system resources. Examples of resources are memory, disk files, and input-output devices.
- When the process ends, it is removed from memory.

**Tip:** If you're using any version of Microsoft Windows, press *Ctrl-Alt-Delete* and select the *Task Manager* item. The Task Manager window lets you view lists of Applications and Processes. Applications are the names of complete programs currently running, such as Windows Explorer or Microsoft Visual C++. When you click on the *Processes* tab, you see a long list of process names. Each of those processes is a small program running independently of all the others. You can continuously track the amount of CPU time and memory used by each process. In some cases, you can shut down a process by selecting its name and pressing the *Delete* key.

### 2.1.5 Section Review

1. The central processor unit (CPU) contains registers and what other basic elements?
2. The central processor unit is connected to the rest of the computer system using what three buses?
3. Why does memory access take more machine cycles than register access?
4. What are the three basic steps in the instruction execution cycle?
5. Which two additional steps are required in the instruction execution cycle when a memory operand is used?

## 2.2 32-Bit x86 Processors

In this section, we focus on the basic architectural features of all x86 processors. This includes members of the Intel IA-32 family as well as all 32-bit AMD processors.

### 2.2.1 Modes of Operation

x86 processors have three primary modes of operation: protected mode, real-address mode, and system management mode. A sub-mode, named *virtual-8086*, is a special case of protected mode. Here are short descriptions of each:



**Protected Mode** Protected mode is the native state of the processor, in which all instructions and features are available. Programs are given separate memory areas named *segments*, and the processor prevents programs from referencing memory outside their assigned segments.

**Virtual-8086 Mode** While in protected mode, the processor can directly execute real-address mode software such as MS-DOS programs in a safe environment. In other words, if a program crashes or attempts to write data into the system memory area, it will not affect other programs running at the same time. A modern operating system can execute multiple separate virtual-8086 sessions at the same time.

**Real-Address Mode** Real-address mode implements the programming environment of an early Intel processor with a few extra features, such as the ability to switch into other modes. This mode is useful if a program requires direct access to system memory and hardware devices.

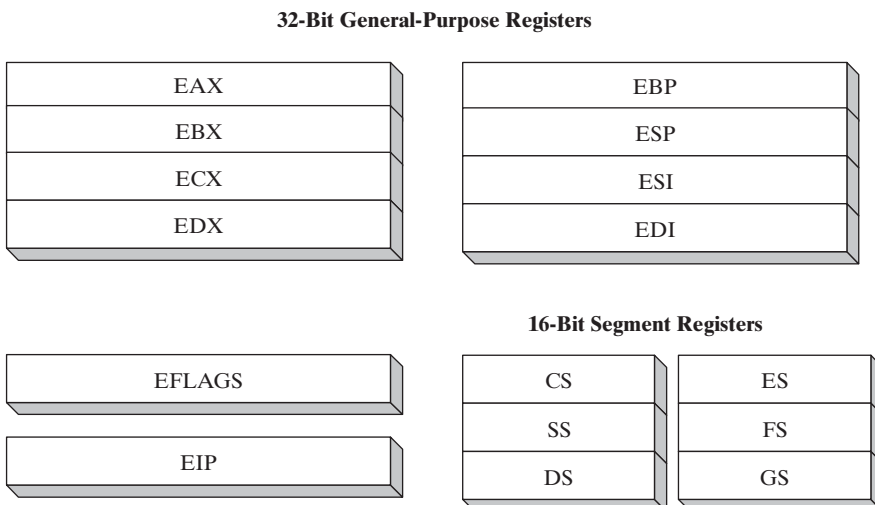
**System Management Mode** System management mode (SMM) provides an operating system with a mechanism for implementing functions such as power management and system security. These functions are usually implemented by computer manufacturers who customize the processor for a particular system setup.

## 2.2.2 Basic Execution Environment

### Address Space

In 32-bit protected mode, a task or program can address a linear address space of up to 4 GBytes. Beginning with the P6 processor, a technique called *extended physical addressing* allows a total of 64 GBytes of physical memory to be addressed. Real-address mode programs, on the other hand, can only address a range of 1 MByte. If the processor is in protected mode and running multiple programs in virtual-8086 mode, each program has its own 1-MByte memory area.

FIGURE 2-3 Basic program execution registers.

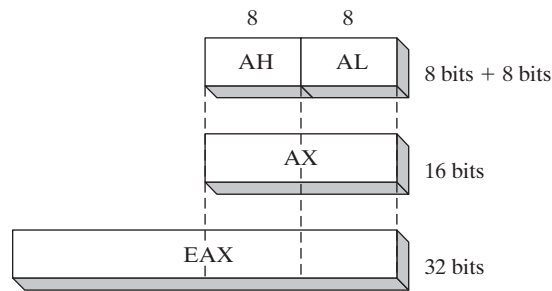


### Basic Program Execution Registers

Registers are high-speed storage locations directly inside the CPU, designed to be accessed at much higher speed than conventional memory. When a processing loop is optimized for speed, for example, loop counters are held in registers rather than variables. Figure 2-3 shows the *basic program execution registers*. There are eight general-purpose registers, six segment registers, a processor status flags register (EFLAGS), and an instruction pointer (EIP).

**General-Purpose Registers** The *general-purpose registers* are primarily used for arithmetic and data movement. As shown in Figure 2-4, the lower 16 bits of the EAX register can be referenced by the name AX.

FIGURE 2-4 General-purpose registers.



Portions of some registers can be addressed as 8-bit values. For example, the AX register has an 8-bit upper half named AH and an 8-bit lower half named AL. The same overlapping relationship exists for the EAX, EBX, ECX, and EDX registers:

32-Bit	16-Bit	8-Bit (High)	8-Bit (Low)
EAX	AX	AH	AL
EBX	BX	BH	BL
ECX	CX	CH	CL
EDX	DX	DH	DL

The remaining general-purpose registers can only be accessed using 32-bit or 16-bit names, as shown in the following table:

32-Bit	16-Bit
ESI	SI
EDI	DI
EBP	BP
ESP	SP

**Specialized Uses** Some general-purpose registers have specialized uses:

- EAX is automatically used by multiplication and division instructions. It is often called the *extended accumulator* register.
- The CPU automatically uses ECX as a loop counter.
- ESP addresses data on the stack (a system memory structure). It is rarely used for ordinary arithmetic or data transfer. It is often called the *extended stack pointer* register.
- ESI and EDI are used by high-speed memory transfer instructions. They are sometimes called the *extended source index* and *extended destination index* registers.
- EBP is used by high-level languages to reference function parameters and local variables on the stack. It should not be used for ordinary arithmetic or data transfer except at an advanced level of programming. It is often called the *extended frame pointer* register.

**Segment Registers** In real-address mode, 16-bit segment registers indicate base addresses of preassigned memory areas named *segments*. In protected mode, segment registers hold pointers to segment descriptor tables. Some segments hold program instructions (code), others hold variables (data), and another segment named the *stack segment* holds local function variables and function parameters.

**Instruction Pointer** The EIP, or *instruction pointer*, register contains the address of the next instruction to be executed. Certain machine instructions manipulate EIP, causing the program to branch to a new location.

**EFLAGS Register** The EFLAGS (or just *Flags*) register consists of individual binary bits that control the operation of the CPU or reflect the outcome of some CPU operation. Some instructions test and manipulate individual processor flags.

A flag is <i>set</i> when it equals 1; it is <i>clear</i> (or reset) when it equals 0.
--

**Control Flags** Control flags control the CPU's operation. For example, they can cause the CPU to break after every instruction executes, interrupt when arithmetic overflow is detected, enter virtual-8086 mode, and enter protected mode.

Programs can set individual bits in the EFLAGS register to control the CPU's operation. Examples are the *Direction* and *Interrupt* flags.

**Status Flags** The status flags reflect the outcomes of arithmetic and logical operations performed by the CPU. They are the Overflow, Sign, Zero, Auxiliary Carry, Parity, and Carry flags. Their abbreviations are shown immediately after their names:

- The **Carry** flag (CF) is set when the result of an *unsigned* arithmetic operation is too large to fit into the destination.
- The **Overflow** flag (OF) is set when the result of a *signed* arithmetic operation is too large or too small to fit into the destination.
- The **Sign** flag (SF) is set when the result of an arithmetic or logical operation generates a negative result.
- The **Zero** flag (ZF) is set when the result of an arithmetic or logical operation generates a result of zero.

- The **Auxiliary Carry** flag (AC) is set when an arithmetic operation causes a carry from bit 3 to bit 4 in an 8-bit operand.
- The **Parity** flag (PF) is set if the least-significant byte in the result contains an even number of 1 bits. Otherwise, PF is clear. In general, it is used for error checking when there is a possibility that data might be altered or corrupted.

### MMX Registers

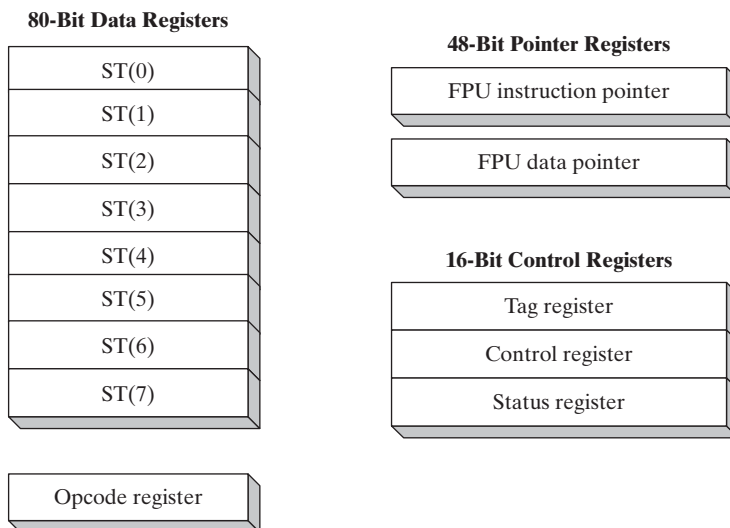
MMX technology improves the performance of Intel processors when implementing advanced multimedia and communications applications. The eight 64-bit MMX registers support special instructions called SIMD (*Single-Instruction, Multiple-Data*). As the name implies, MMX instructions operate in parallel on the data values contained in MMX registers. Although they appear to be separate registers, the MMX register names are in fact aliases to the same registers used by the floating-point unit.

### XMM Registers

The x86 architecture also contains eight 128-bit registers called XMM registers. They are used by streaming SIMD extensions to the instruction set.

**Floating-Point Unit** The *floating-point unit* (FPU) performs high-speed floating-point arithmetic. At one time a separate coprocessor chip was required for this. From the Intel486 onward, the FPU has been integrated into the main processor chip. There are eight floating-point data registers in the FPU, named ST(0), ST(1), ST(2), ST(3), ST(4), ST(5), ST(6), and ST(7). The remaining control and pointer registers are shown in Figure 2-5.

FIGURE 2-5 Floating-point unit registers.



### 2.2.3 x86 Memory Management

x86 processors manage memory according to the basic modes of operation discussed in Section 2.2.1. Protected mode is the most robust and powerful, but it does restrict application programs from directly accessing system hardware.

In *real-address* mode, only 1 MByte of memory can be addressed, from hexadecimal 00000 to FFFFF. The processor can run only one program at a time, but it can momentarily interrupt that program to process requests (called *interrupts*) from peripherals. Application programs are permitted to access any memory location, including addresses that are linked directly to system hardware. The MS-DOS operating system runs in real-address mode, and Windows 95 and 98 can be booted into this mode.

In *protected* mode, the processor can run multiple programs at the same time. It assigns each process (running program) a total of 4 GByte of memory. Each program can be assigned its own reserved memory area, and programs are prevented from accidentally accessing each other's code and data. MS-Windows and Linux run in protected mode.

In *virtual-8086* mode, the computer runs in protected mode and creates a virtual-8086 machine with its own 1-MByte address space that simulates an 80x86 computer running in real-address mode. Windows NT and 2000, for example, create a virtual-8086 machine when you open a *Command* window. You can run many such windows at the same time, and each is protected from the actions of the others. Some MS-DOS programs that make direct references to computer hardware will not run in this mode under Windows NT, 2000, and XP.

Chapter 11 explains many more details of both real-address mode and protected mode.

### 2.2.4 Section Review

1. What are the x86 processor's three basic modes of operation?
2. Name all eight 32-bit general-purpose registers.
3. Name all six segment registers.
4. What special purpose does the ECX register serve?

## 2.3 64-Bit x86-64 Processors

In this section, we focus on the basic architectural details of all 64-bit processors that use the x86-64 instruction set. This group the Intel 64 and AMD64 processor families. The instruction set is a 64-bit extension of the x86 instruction set we've already looked at. Here are some of the essential features:

1. It is backward-compatible with the x86 instruction set.
2. Addresses are 64 bits long, allowing for a virtual address space of size  $2^{64}$  bytes. In current chip implementations, only the lowest 48 bits are used.
3. It can use 64-bit general-purpose registers, allowing instructions to have 64-bit integer operands.
4. It uses eight more general-purpose registers than the x86.
5. It uses a 48-bit physical address space, which supports up to 256 terabytes of RAM.

On the other hand, when running in native 64-bit mode, these processors do not support 16-bit real mode or virtual-8086 mode. (There is a *legacy mode* that still supports 16-bit programming, but it is not available in 64-bit versions of Microsoft Windows.)

**Note:** Although *x86-64* refers to an instruction set, we will from this point on treat it as a processor type. For the purpose of learning assembly language, it is not necessary to consider hardware implementation differences between processors that support x86-64.

The first Intel processor to use x86-64 was the Xeon, followed by a host of other processors, including Core i5 and Core i7 processors. Examples of AMD's processors that use x86-64 are Opteron and Athlon 64.

You might also have heard of another 64-bit architecture from Intel known as *IA-64*, later renamed to *Itanium*. The IA-64 instruction set is completely different from x86 and x86-64. Itanium processors are often used for high-performance database and network servers.

### 2.3.1 64-Bit Operation Modes

The Intel 64 architecture introduces a new mode named *IA-32e*. Technically it contains two submodes, named *compatibility mode* and *64-bit mode*. But it's easier to refer to these as modes rather than submodes, so we will do that from now on.

#### **Compatibility Mode**

When running in compatibility mode, existing 16-bit and 32-bit applications can usually run without being recompiled. However, 16-bit Windows (Win16) and DOS applications will not run in 64-bit Microsoft Windows. Unlike earlier versions of Windows, 64-bit Windows does not have a virtual DOS machine subsystem to take advantage of the processor's ability to switch into virtual-8086 mode.

#### **64-Bit Mode**

In 64-bit mode, the processor runs applications that use the 64-bit linear address space. This is the native mode for 64-bit Microsoft Windows. This mode enables 64-bit instruction operands.

### 2.3.2 Basic 64-Bit Execution Environment

In 64-bit mode, addresses can theoretically be as large as 64-bits, although processors currently only support 48 bits for addresses. In terms of registers, the following are the most important differences from 32-bit processors:

- Sixteen 64-bit general purpose registers (in 32-bit mode, you have only eight general-purpose registers)
- Eight 80-bit floating-point registers
- A 64-bit status flags register named RFLAGS (only the lower 32 bits are used)
- A 64-bit instruction pointer named RIP

As you may recall, the 32-bit flags and instruction pointers are named EFLAGS and EIP. In addition, there are some specialized registers for multimedia processing we mentioned when talking about the x86 processor:

- Eight 64-bit MMX registers
- Sixteen 128-bit XMM registers (in 32-bit mode, you have only 8 of these)

#### **General-Purpose Registers**

The general-purpose registers, introduced when we described 32-bit processors, are the basic operands for instructions that do arithmetic, move data, and loop through data. The general-purpose registers can access 8-bit, 16-bit, 32-bit, or 64-bit operands (with a special prefix).

In 64-bit mode, the default operand size is 32 bits and there are eight general-purpose registers. By adding the REX (register extension) prefix to each instruction, however, the operands can be 64 bits long and a total of 16 general-purpose registers become available. You have all the

same registers as in 32-bit mode, plus eight numbered registers, R8 through R15. Table 2-1 shows which registers are available when the REX prefix is enabled.

Table 2-1 Operand Sizes in 64-Bit Mode When REX Is Enabled.

Operand Size	Available Registers
8 bits	AL, BL, CL, DL, SIL, BPL, SPL, R8L, R9L, R10L, R11L, R12L, R13L, R14L, R15L
16 bits	AX, BX, CX, DX, DI, SI, BP, SP, R8W, R9W, R10W, R11W, R12W, R13W, R14W, R15W
32 bits	EAX, EBX, ECX, EDX, EDI, ESI, EBP, ESP, R8D, R9D, R10D, R11D, R12D, R13D, R14D, R15D
64 bits	RAX, RBX, RCX, RDX, RDI, RSI, RBP, RSP, R8, R9, R10, R11, R12, R13, R14, R15

Here are a few more details to remember:

- In 64-bit mode, a single instruction cannot access both a high-byte register, such as AH, BH, CH, and DH, and at the same time, the low byte of one of the new byte registers (such as DIL).
- The 32-bit EFLAGS register is replaced by a 64-bit RFLAGS register in 64-bit mode. The two registers share the same lower 32 bits, and the upper 32 bits of RFLAGS are not used.
- The status flags are the same in 32-bit mode and 64-bit mode.

## 2.4 Components of a Typical x86 Computer

Let us look at how the x86 integrates with other components by examining a typical motherboard configuration and the set of chips that surround the CPU. Then we will discuss memory, I/O ports, and common device interfaces. Finally, we will show how assembly language programs can perform I/O at different levels of access by tapping into system hardware, firmware, and by calling functions in the operating system.

### 2.4.1 Motherboard

The heart of a microcomputer is its *motherboard*, a flat circuit board onto which are placed the computer's CPU, supporting processors (*chipset*), main memory, input-output connectors, power supply connectors, and expansion slots. The various components are connected to each other by a *bus*, a set of wires etched directly on the motherboard. Dozens of motherboards are available on the PC market, varying in expansion capabilities, integrated components, and speed. The following components have traditionally been found on PC motherboards:

- A CPU socket. Sockets are different shapes and sizes, depending on the type of processor they support
- Memory slots (SIMM or DIMM), holding small plug-in memory boards
- BIOS (*basic input-output system*) computer chips, holding system software
- CMOS RAM, with a small circular battery to keep it powered
- Connectors for mass-storage devices such as hard drives and CD-ROMs
- USB connectors for external devices
- Keyboard and mouse ports

- PCI bus connectors for sound cards, graphics cards, data acquisition boards, and other input–output devices

The following components are optional:

- Integrated sound processor
- Parallel and serial device connectors
- Integrated network adapter
- AGP bus connector for a high-speed video card

Following are some important support processors in a typical system:

- The *Floating-Point Unit* (FPU) handles floating-point and extended integer calculations.
- The 8284/82C284 *Clock Generator*, known simply as the *clock*, oscillates at a constant speed. The clock generator synchronizes the CPU and the rest of the computer.
- The 8259A *Programmable Interrupt Controller* (PIC) handles external interrupts from hardware devices, such as the keyboard, system clock, and disk drives. These devices interrupt the CPU and make it process their requests immediately.
- The 8253 *Programmable Interval Timer/Counter* interrupts the system 18.2 times per second, updates the system date and clock, and controls the speaker. It is also responsible for constantly refreshing memory because RAM memory chips can remember their data for only a few milliseconds.
- The 8255 *Programmable Parallel Port* transfers data to and from the computer using the IEEE Parallel Port interface. This port is commonly used for printers, but it can be used with other input–output devices as well.

### **PCI and PCI Express Bus Architectures**

The **PCI** (*Peripheral Component Interconnect*) bus provides a connecting bridge between the CPU and other system devices such as hard drives, memory, video controllers, sound cards, and network controllers. More recently, the *PCI Express* bus provides two-way serial connections between devices, memory, and the processor. It carries data in packets, similar to networks, in separate “lanes.” It is widely supported by graphics controllers, and can transfer data at very high speeds.

### **Motherboard Chipset**

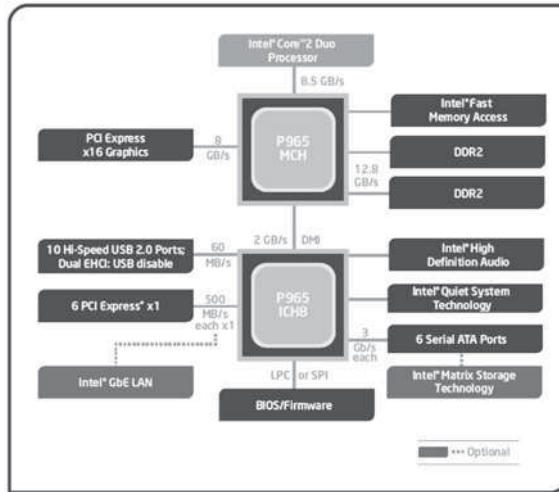
A *motherboard chipset* is a collection of processor chips designed to work together on a specific type of motherboard. Various chipsets have features that increase processing power, multimedia capabilities, or reduce power consumption. The *Intel P965 Express Chipset* can be used as an example. It is used in desktop PCs, with either an Intel Core 2 Duo or a Pentium D processor. Here are some of its features:

- Intel *Fast Memory Access* uses an updated Memory Controller Hub (MCH). It can access dual-channel DDR2 memory, at an 800 MHz clock speed.
- An I/O Controller Hub (Intel ICH8/R/DH) uses Intel Matrix Storage Technology (MST) to support multiple Serial ATA devices (disk drives).
- Support for multiple USB ports, multiple PCI express slots, networking, and Intel Quiet System technology.
- A high definition audio chip provides digital sound capabilities.



A diagram may be seen in Figure 2-6. Motherboard manufacturers will build products around specific chipsets. For example, the P5B-E P965 motherboard by Asus Corporation uses the P965 chipset.

FIGURE 2-6 Intel 965 express chipset block diagram.



Source: The Intel P965 Express Chipset (product brief), © 2006 by Intel Corporation, used by permission.

## 2.4.2 Memory

Several basic types of memory are used in Intel-based systems: read-only memory (ROM), erasable programmable read-only memory (EPROM), dynamic random-access memory (DRAM), static RAM (SRAM), video RAM (VRAM), and complimentary metal oxide semiconductor (CMOS) RAM:

- **ROM** is permanently burned into a chip and cannot be erased.
- **EPROM** can be erased slowly with ultraviolet light and reprogrammed.
- **DRAM**, commonly known as main memory, is where programs and data are kept when a program is running. It is inexpensive, but must be refreshed every millisecond to avoid losing its contents. Some systems use ECC (error checking and correcting) memory.
- **SRAM** is used primarily for expensive, high-speed cache memory. It does not have to be refreshed. CPU cache memory is comprised of SRAM.
- **VRAM** holds video data. It is dual ported, allowing one port to continuously refresh the display while another port writes data to the display.
- **CMOS RAM** on the system motherboard stores system setup information. It is refreshed by a battery, so its contents are retained when the computer's power is off.

## 2.4.3 Section Review

1. Describe SRAM and its most common use.
2. Describe VRAM.

3. List at least two features found in the Intel P965 Express chipset.
4. Name four types of RAM mentioned in this chapter.
5. What is the purpose of the 8259A PIC controller?

## 2.5 Input–Output System

**Tip:** Because computer games are so memory and I/O intensive, they push computer performance to the max. Programmers who excel at game programming often know a lot about video and sound hardware, and optimize their code for hardware features.

### 2.5.1 Levels of I/O Access

Application programs routinely read input from keyboard and disk files and write output to the screen and to files. I/O need not be accomplished by directly accessing hardware—instead, you can call functions provided by the operating system. I/O is available at different access levels, similar to the virtual machine concept shown in Chapter 1. There are three primary levels:

- **High-level language functions:** A high-level programming language such as C++ or Java contains functions to perform input–output. These functions are portable because they work on a variety of different computer systems and are not dependent on any one operating system.
- **Operating system:** Programmers can call operating system functions from a library known as the API (*application programming interface*). The operating system provides high-level operations such as writing strings to files, reading strings from the keyboard, and allocating blocks of memory.
- **BIOS:** The *basic input–output system* is a collection of low-level subroutines that communicate directly with hardware devices. The BIOS is installed by the computer’s manufacturer and is tailored to fit the computer’s hardware. Operating systems typically communicate with the BIOS.

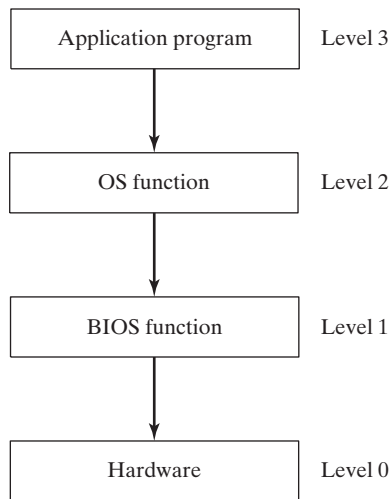
**Device Drivers** *Device drivers* are programs that permit the operating system to communicate directly with hardware devices and the system BIOS. For example, a device driver might receive a request from the OS to read some data; the device driver satisfies the request by executing code in the device firmware that reads data in a way that is unique to the device. Device drivers are usually installed in one of two ways: (1) before a specific hardware device is attached to a computer, or (2) after a device has been attached and identified. In the latter case, the OS recognizes the device name and signature; it then locates and installs the device driver software onto the computer.

We can put the I/O hierarchy into perspective by showing what happens when an application program displays a string of characters on the screen (Fig. 2-7). The following steps are involved:

1. A statement in the application program calls an HLL library function that writes the string to standard output.
2. The library function (Level 3) calls an operating system function, passing a string pointer.

3. The operating system function (Level 2) uses a loop to call a BIOS subroutine, passing it the ASCII code and color of each character. The operating system calls another BIOS subroutine to advance the cursor to the next position on the screen.
4. The BIOS subroutine (Level 1) receives a character, maps it to a particular system font, and sends the character to a hardware port attached to the video controller card.
5. The video controller card (Level 0) generates timed hardware signals to the video display that control the raster scanning and displaying of pixels.

FIGURE 2-7 Access levels for input–output operations.

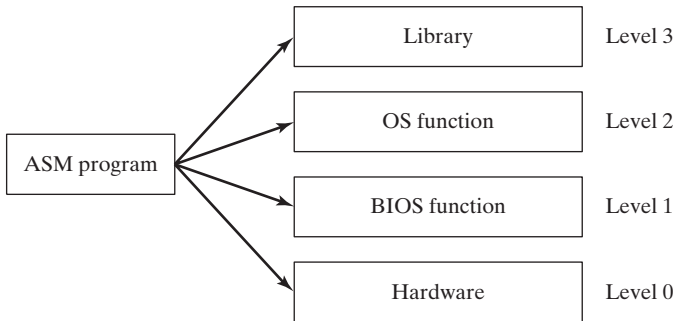


**Programming at Multiple Levels** Assembly language programs have power and flexibility in the area of input-output programming. They can choose from the following access levels (Figure 2-8):

- Level 3: Call library functions to perform generic text I/O and file-based I/O. We supply such a library with this book, for instance.
- Level 2: Call operating system functions to perform generic text I/O and file-based I/O. If the OS uses a graphical user interface, it has functions to display graphics in a device-independent way.
- Level 1: Call BIOS functions to control device-specific features such as color, graphics, sound, keyboard input, and low-level disk I/O.
- Level 0: Send and receive data from hardware ports, having absolute control over specific devices. This approach cannot be used with a wide variety of hardware devices, so we say that it is *not portable*. Different devices often use different hardware ports, so the program code must be customized for each specific type of device.

What are the tradeoffs? Control versus portability is the primary one. Level 2 (OS) works on any computer running the same operating system. If an I/O device lacks certain capabilities, the OS will do its best to approximate the intended result. Level 2 is not particularly fast because each I/O call must go through several layers before it executes.

FIGURE 2-8 Assembly language access levels.



Level 1 (BIOS) works on all systems having a standard BIOS, but will not produce the same result on all systems. For example, two computers might have video displays with different resolution capabilities. A programmer at Level 1 would have to write code to detect the user's hardware setup and adjust the output format to match. Level 1 runs faster than Level 2 because it is only one level above the hardware.

Level 0 (hardware) works with generic devices such as serial ports and with specific I/O devices produced by known manufacturers. Programs using this level must extend their coding logic to handle variations in I/O devices. Real-mode game programs are prime examples because they usually take control of the computer. Programs at this level execute as quickly as the hardware will permit.

Suppose, for example, you wanted to play a WAV file using an audio controller device. At the OS level, you would not have to know what type of device was installed, and you would not be concerned with nonstandard features the card might have. At the BIOS level, you would query the sound card (using its installed device driver software) and find out whether it belonged to a certain class of sound cards having known features. At the hardware level, you would fine tune the program for certain models of audio cards, taking advantage of each card's special features.

General-purpose operating systems rarely permit application programs to directly access system hardware, because to do so would make it nearly impossible for multiple programs to run simultaneously. Instead, hardware is accessed only by device drivers, in a carefully controlled manner. On the other hand, smaller operating systems for specialized devices often do connect directly to hardware. They do this in order to reduce the amount of memory taken up by operating system code, and they almost always run just a single program at one time. The last Microsoft operating system to allow programs to directly access hardware was MS-DOS, and it was only able to run one program at a time.

### 2.5.2 Section Review

1. Of the four levels of input/output in a computer system, which is the most universal and portable?
2. What characteristics distinguish BIOS-level input/output?
3. Why are device drivers necessary, given that the BIOS already has code that communicates with the computer's hardware?

4. In the example regarding displaying a string of characters, which level exists between the operating system and the video controller card?
5. Is it likely that the BIOS for a computer running MS-Windows would be different from that used by a computer running Linux?

## 2.6 Chapter Summary

The central processor unit (CPU) is where calculations and logic processing occur. It contains a limited number of storage locations called *registers*, a high-frequency clock to synchronize its operations, a control unit, and an arithmetic logic unit. The memory storage unit is where instructions and data are held while a computer program is running. A *bus* is a series of parallel wires that transmit data among various parts of the computer.

The execution of a single machine instruction can be divided into a sequence of individual operations called the *instruction execution cycle*. The three primary operations are fetch, decode, and execute. Each step in the instruction cycle takes at least one tick of the system clock, called a *clock cycle*. The *load and execute* sequence describes how a program is located by the operating system, loaded into memory, and executed by the operating system.

x86 processors have three basic modes of operation: *protected* mode, *real-address* mode, and *system management* mode. In addition, *virtual-8086* mode is a special case of protected mode. Intel64 processors have two basic modes of operation: *compatibility mode* and *64-bit mode*. In compatibility mode they can run 16-bit and 32-bit applications.

*Registers* are named locations within the CPU that can be accessed much more quickly than conventional memory. Following are brief descriptions of register types:

- The *general-purpose* registers are primarily used for arithmetic, data movement, and logical operations.
- The *segment registers* are used as base locations for preassigned memory areas called segments.
- The *instruction pointer* register contains the address of the next instruction to be executed.
- The *flags* register consists of individual binary bits that control the operation of the CPU and reflect the outcome of ALU operations.

The x86 has a floating-point unit (FPU) expressly used for the execution of high-speed floating-point instructions.

The heart of any microcomputer is its motherboard, holding the computer's CPU, supporting processors, main memory, input–output connectors, power supply connectors, and expansion slots. The PCI (Peripheral Component Interconnect) bus provides a convenient upgrade path for Pentium processors. Most motherboards contain an integrated set of several microprocessors and controllers, called a chipset. The chipset largely determines the capabilities of the computer.

Several basic types of memory are used in PCs: ROM, EPROM, Dynamic RAM (DRAM), Static RAM (SRAM), Video RAM (VRAM), and CMOS RAM.

Input–output is accomplished via different access levels, similar to the virtual machine concept. Library functions are at the highest level, and the operating system is at the next level

below. The BIOS (basic input–output system) is a collection of functions that communicate directly with hardware devices. Programs can also directly access input–output devices.

## 2.7 Key Terms

32-bit mode  
 64-bit mode  
 address bus  
 application programming interface (API)  
 arithmetic logic unit (ALU)  
 auxiliary carry flag  
 basic program execution registers  
 BIOS (basic input–output system)  
 bus  
 cache  
 carry flag  
 central processor unit (CPU)  
 clock  
 clock cycle  
 clock generator  
 code cache  
 control flags  
 control unit  
 data bus  
 data cache  
 device drivers  
 direction flag  
 dynamic RAM  
 EFLAGS register  
 extended destination index  
 extended physical addressing  
 extended source index  
 extended stack pointer  
 fetch–decode–execute  
 flags register  
 floating-point unit  
 general-purpose registers  
 instruction decoder  
 instruction execution cycle  
 instruction queue  
 instruction pointer  
 interrupt flag  
 Level-1 cache  
 Level-2 cache  
 machine cycle  
 memory storage unit  
 MMX registers  
 motherboard  
 motherboard chipset  
 operating system (OS)  
 overflow flag  
 parity flag  
 PCI (peripheral component interconnect)  
 PCI express  
 process  
 process ID  
 programmable interrupt controller (PIC)  
 programmable interval timer/counter  
 programmable parallel port  
 protected mode  
 random access memory (RAM)  
 read-only memory (ROM)  
 real-address mode  
 registers  
 segment registers  
 sign flag  
 single-instruction, multiple-data (SIMD)  
 static RAM  
 status flags  
 system management mode (SMM)  
 Task Manager  
 virtual-8086 mode  
 wait states  
 XMM registers  
 zero flag

## 2.8 Review Questions

1. In 32-bit mode, aside from the stack pointer (ESP), what other register points to variables on the stack?
2. Name at least four CPU status flags.
3. Which flag is set when the result of an *unsigned* arithmetic operation is too large to fit into the destination?
4. Which flag is set when the result of a *signed* arithmetic operation is either too large or too small to fit into the destination?
5. (*True/False*): When a register operand size is 32 bits and the REX prefix is used, the R8D register is available for programs to use.
6. Which flag is set when an arithmetic or logical operation generates a negative result?
7. Which part of the CPU performs floating-point arithmetic?
8. On a 32-bit processor, how many bits are contained in each floating-point data register?
9. (*True/False*): The x86-64 instruction set is backward-compatible with the x86 instruction set.
10. (*True/False*): In current 64-bit chip implementations, all 64 bits are used for addressing.
11. (*True/False*): The Itanium instruction set is completely different from the x86 instruction set.
12. (*True/False*): Static RAM is usually less expensive than dynamic RAM.
13. (*True/False*): The 64-bit RDI register is available when the REX prefix is used.
14. (*True/False*): In native 64-bit mode, you can use 16-bit real mode, but not the virtual-8086 mode.
15. (*True/False*): The x86-64 processors have 4 more general-purpose registers than the x86 processors.
16. (*True/False*): The 64-bit version of Microsoft Windows does not support virtual-8086 mode.
17. (*True/False*): DRAM can only be erased using ultraviolet light.
18. (*True/False*): In 64-bit mode, you can use up to eight floating-point registers.
19. (*True/False*): A bus is a plastic cable that is attached to the motherboard at both ends, but does not sit directly on the motherboard.
20. (*True/False*): CMOS RAM is the same as static RAM, meaning that it holds its value without any extra power or refresh cycles.
21. (*True/False*): PCI connectors are used for graphics cards and sound cards.
22. (*True/False*): The 8259A is a controller that handles external interrupts from hardware devices.
23. (*True/False*): The acronym PCI stands for *programmable component interface*.
24. (*True/False*): VRAM stands for virtual random access memory.
25. At which level(s) can an assembly language program manipulate input/output?
26. Why do game programs often send their sound output directly to the sound card's hardware ports?

---

# ASSEMBLY LANGUAGE FUNDAMENTALS

- 3.1 Basic Language Elements**
  - 3.1.1 First Assembly Language Program
  - 3.1.2 Integer Literals
  - 3.1.3 Constant Integer Expressions
  - 3.1.4 Real Number Literals
  - 3.1.5 Character Literals
  - 3.1.6 String Literals
  - 3.1.7 Reserved Words
  - 3.1.8 Identifiers
  - 3.1.9 Directives
  - 3.1.10 Instructions
  - 3.1.11 Section Review
- 3.2 Example: Adding and Subtracting Integers**
  - 3.2.1 The *AddTwo* Program
  - 3.2.2 Running and Debugging the *AddTwo* Program
  - 3.2.3 Program Template
  - 3.2.4 Section Review
- 3.3 Assembling, Linking, and Running Programs**
  - 3.3.1 The Assemble-Link-Execute Cycle
  - 3.3.2 Listing File
  - 3.3.3 Section Review
- 3.4 Defining Data**
  - 3.4.1 Intrinsic Data Types
  - 3.4.2 Data Definition Statement
  - 3.4.3 Adding a Variable to the *AddTwo* Program
  - 3.4.4 Defining BYTE and SBYTE Data
  - 3.4.5 Defining WORD and SWORD Data
  - 3.4.6 Defining DWORD and SDWORD Data
  - 3.4.7 Defining QWORD Data
  - 3.4.8 Defining Packed BCD (TBYTE) Data
  - 3.4.9 Defining Floating-Point Types
  - 3.4.10 A Program that Adds Variables
  - 3.4.11 Little-Endian Order
  - 3.4.12 Declaring Uninitialized Data
  - 3.4.13 Section Review
- 3.5 Symbolic Constants**
  - 3.5.1 Equal-Sign Directive
  - 3.5.2 Calculating the Sizes of Arrays and Strings
  - 3.5.3 EQU Directive
  - 3.5.4 TEXTEQU Directive
  - 3.5.5 Section Review
- 3.6 64-Bit Programming**
- 3.7 Chapter Summary**
- 3.8 Key Terms**
  - 3.8.1 Terms
  - 3.8.2 Instructions, Operators, and Directives
- 3.9 Review Questions and Exercises**
  - 3.9.1 Short Answer
  - 3.9.2 Algorithm Workbench
- 3.10 Programming Exercises**



This chapter focuses on the basic building blocks of the Microsoft MASM assembler. You will see how constants and variables are defined, standard formats for numeric and string literals, and how to assemble and run your first programs. We particularly emphasize the Visual Studio debugger in this chapter, as an excellent tool for understanding how programs work. The important thing in this chapter is to move one step at a time, mastering each detail before you move to the next step. You are building a foundation that will greatly help you in upcoming chapters.

## 3.1 Basic Language Elements

### 3.1.1 First Assembly Language Program

Assembly language programming might have a reputation for being obscure and tricky, but we like to think of it another way—it is a language that gives you nearly total information. You get to see everything that is going on, even in the CPU's registers and flags! With this powerful ability, however, you have the responsibility to manage data representation details and instruction formats. You work at a very detailed level. To see how this works, let's look at a simple assembly language program that adds two numbers and saves the result in a register. We will call it the *AddTwo* program:

```
1: main PROC
2:   mov eax,5           ; move 5 to the eax register
3:   add eax,6           ; add 6 to the eax register
4:
5:   INVOKE ExitProcess,0 ; end the program
6: main ENDP
```

Although line numbers have been inserted in the beginning of each line to aid our discussion, you never actually type line numbers when you create assembly programs. Also, don't try to type in and run this program just yet—it's missing some important declarations that we will include later on in this chapter.

Let's go through the program one line at a time: Line 1 starts the **main** procedure, the entry point for the program. Line 2 places the integer 5 in the **eax** register. Line 3 adds 6 to the value in EAX, giving it a new value of 11. Line 5 calls a Windows service (also known as a function) named **ExitProcess** that halts the program and returns control to the operating system. Line 6 is the ending marker of the main procedure.

You probably noticed that we included comments, which always begin with a semicolon character. We've left out a few declarations at the top of the program that we can show later, but essentially this is a working program. It does not display anything on the screen, but we could run it with a utility program called a *debugger* that would let us step through the program one line at a time and look at the register values. Later in this chapter, we will show how to do that.

#### **Adding a Variable**

Let's make our program a little more interesting by saving the results of our addition in a variable named **sum**. To do this, we will add a couple of markers, or declarations, that identify the code and data areas of the program:

```

1: .data                ; this is the data area
2: sum DWORD 0         ; create a variable named sum
3:
4: .code                ; this is the code area
5: main PROC
6:     mov eax,5        ; move 5 to the eax register
7:     add eax,6        ; add 6 to the eax register
8:     mov sum,eax
9:
10:    INVOKE ExitProcess,0 ; end the program
11: main ENDP

```

The **sum** variable is declared on Line 2, where we give it a size of 32 bits, using the `DWORD` keyword. There are a number of these size keywords, which work more or less like data types. But they are not as specific as types you might be familiar with, such as `int`, `double`, `float`, and so on. They only specify a size, but there’s no checking into what actually gets put inside the variable. Remember, you are in total control.

By the way, those code and data areas we mentioned, which were marked by the `.code` and `.data` directives, are called *segments*. So you have the code segment and the data segment. Later on, we will see a third segment named **stack**.

Next, let’s dive deeper into some of the language details, showing how to declare literals (also known as constants), identifiers, directives, and instructions. You will probably have to read this chapter a couple of times to retain it all, but it’s definitely worth the time. By the way, throughout this chapter, when we refer to syntax rules imposed by the assembler, we really mean rules imposed by the Microsoft MASM assembler. Other assemblers are out there with different syntax rules, but we will ignore them. We will probably save at least one tree (somewhere in the world) by not reprinting the word MASM every time we refer to the assembler.

### 3.1.2 Integer Literals

An *integer literal* (also known as an *integer constant*) is made up of an optional leading sign, one or more digits, and an optional radix character that indicates the number’s base:

```
[{+ | -}] digits [ radix ]
```

We will use Microsoft syntax notation throughout the book. Elements within square brackets [..] are optional and elements within braces {..} require a choice of one of the enclosed elements, separated by the | character. Elements in *italics* identify items that have known definitions or descriptions.

So, for example, 26 is a valid integer literal. It doesn’t have a radix, so we assume it’s in decimal format. If we wanted it to be 26 hexadecimal, we would have to write it as 26h. Similarly, the number 1101 would be considered a decimal value until we added a “b” at the end to make it 1101b (binary). Here are the possible radix values:

h	hexadecimal	r	encoded real
q/o	octal	t	decimal (alternate)
d	decimal	y	binary (alternate)
b	binary		

And here are some integer literals declared with various radixes. Each line contains a comment:

```

26                ; decimal
26d              ; decimal
11010011b       ; binary
42q              ; octal
42o              ; octal
1Ah              ; hexadecimal
0A3h             ; hexadecimal

```

A hexadecimal literal beginning with a letter must have a leading zero to prevent the assembler from interpreting it as an identifier.

### 3.1.3 Constant Integer Expressions

A *constant integer expression* is a mathematical expression involving integer literals and arithmetic operators. Each expression must evaluate to an integer, which can be stored in 32 bits (0 through FFFFFFFh). The arithmetic operators are listed in Table 3-1 according to their precedence order, from highest (1) to lowest (4). The important thing to realize about constant integer expressions is that they can only be evaluated at assembly time. From now on, we will just call them *integer expressions*.

TABLE 3-1 Arithmetic Operators.

Operator	Name	Precedence Level
()	Parentheses	1
+, -	Unary plus, minus	2
*, /	Multiply, divide	3
MOD	Modulus	3
+, -	Add, subtract	4

*Operator precedence* refers to the implied order of operations when an expression contains two or more operators. The order of operations is shown for the following expressions:

```

4 + 5 * 2          Multiply, add
12 -1 MOD 5        Modulus, subtract
-5 + 2             Unary minus, add
(4 + 2) * 6        Add, multiply

```

The following are examples of valid expressions and their values:

Expression	Value
16 / 5	3
-(3 + 4) * (6 - 1)	-35

Expression	Value
$-3 + 4 * 6 - 1$	20
$25 \bmod 3$	1

Suggestion: Use parentheses in expressions to clarify the order of operations so you don't have to remember precedence rules.

### 3.1.4 Real Number Literals

*Real number literals* (also known as *floating-point literals*) are represented as either decimal reals or encoded (hexadecimal) reals. A *decimal real* contains an optional sign followed by an integer, a decimal point, an optional integer that expresses a fraction, and an optional exponent:

`[sign] integer. [integer] [exponent]`

These are the formats for the sign and exponent:

`sign`            `{+, -}`  
`exponent`    `E[ {+, -} ] integer`

Following are examples of valid decimal reals:

`2.`  
`+3.0`  
`-44.2E+05`  
`26.E5`

At least one digit and a decimal point are required.

An *encoded real* represents a real number in hexadecimal, using the IEEE floating-point format for short reals (see Chapter 12). The binary representation of decimal +1.0, for example, is

`0011 1111 1000 0000 0000 0000 0000 0000`

The same value would be encoded as a short real in assembly language as

`3F800000r`

We will not be using real-number constants for a while, because most of the x86 instruction set is geared toward integer processing. However, Chapter 12 will show how to do arithmetic with real numbers, also known as floating-point numbers. It's very interesting, and very technical.

### 3.1.5 Character Literals

A *character literal* is a single character enclosed in single or double quotes. The assembler stores the value in memory as the character's binary ASCII code. Examples are

`'A'`  
`"d"`

Recall that Chapter 1 showed that character literals are stored internally as integers, using the ASCII encoding sequence. So, when you write the character constant "A," it's stored in memory

as the number 65 (or 41 hex). We have a complete table of ASCII codes on the inside back cover of this book, so be sure to look over them from time to time.

### 3.1.6 String Literals

A *string literal* is a sequence of characters (including spaces) enclosed in single or double quotes:

```
'ABC'  
'X'  
"Good night, Gracie"  
'4096'
```

Embedded quotes are permitted when used in the manner shown by the following examples:

```
"This isn't a test"  
'Say "Good night," Gracie'
```

Just as character constants are stored as integers, we can say that string literals are stored in memory as sequences of integer byte values. So, for example, the string literal “ABCD” contains the four bytes 41h, 42h, 43h, and 44h.

### 3.1.7 Reserved Words

*Reserved words* have special meaning and can only be used in their correct context. Reserved words, by default, are not case-sensitive. For example, MOV is the same as mov and Mov. There are different types of reserved words:

- Instruction mnemonics, such as MOV, ADD, and MUL
- Register names
- Directives, which tell the assembler how to assemble programs
- Attributes, which provide size and usage information for variables and operands. Examples are BYTE and WORD
- Operators, used in constant expressions
- Predefined symbols, such as @data, which return constant integer values at assembly time

A common list of reserved words can be found in Appendix A.

### 3.1.8 Identifiers

An *identifier* is a programmer-chosen name. It might identify a variable, a constant, a procedure, or a code label. There are a few rules on how they can be formed:

- They may contain between 1 and 247 characters.
- They are not case sensitive.
- The first character must be a letter (A..Z, a..z), underscore (\_), @, ?, or \$. Subsequent characters may also be digits.
- An identifier cannot be the same as an assembler reserved word.

**Tip:** You can make all keywords and identifiers case sensitive by adding the `-Cp` command line switch when running the assembler.

In general, it's a good idea to use descriptive names for identifiers, as you do in high-level programming language code. Although assembly language instructions are short and cryptic, there's no reason to make your identifiers hard to understand also! Here are some examples of well-formed names:

```
lineCount    firstValue    index    line_count
myFile      xCoord      main     x_Coord
```

The following names are legal, but not as desirable:

```
_lineCount  $first      @myFile
```

Generally, you should avoid the @ symbol and underscore as leading characters, since they are used both by the assembler and by high-level language compilers.

### 3.1.9 Directives

A *directive* is a command embedded in the source code that is recognized and acted upon by the assembler. Directives do not execute at runtime, but they let you define variables, macros, and procedures. They can assign names to memory segments and perform many other housekeeping tasks related to the assembler. Directives are not, by default, case sensitive. For example, **.data**, **.DATA**, and **.Data** are equivalent.

The following example helps to show the difference between directives and instructions. The **DWORD** directive tells the assembler to reserve space in the program for a doubleword variable. The **MOV** instruction, on the other hand, executes at runtime, copying the contents of **myVar** to the **EAX** register:

```
myVar  DWORD 26
mov    eax, myVar
```

Although all assemblers for Intel processors share the same instruction set, they usually have different sets of directives. The Microsoft assembler's **REPT** directive, for example, is not recognized by some other assemblers.

**Defining Segments** One important function of assembler directives is to define program sections, or *segments*. Segments are sections of a program that have different purposes. For example, one segment can be used to define variables, and is identified by the **.DATA** directive:

```
.data
```

The **.CODE** directive identifies the area of a program containing executable instructions:

```
.code
```

The **.STACK** directive identifies the area of a program holding the runtime stack, setting its size:

```
.stack 100h
```

Appendix A contains a useful reference for directives and operators.

### 3.1.10 Instructions

An *instruction* is a statement that becomes executable when a program is assembled. Instructions are translated by the assembler into machine language bytes, which are loaded and executed by the CPU at runtime. An instruction contains four basic parts:

- Label (optional)
- Instruction mnemonic (required)
- Operand(s) (usually required)
- Comment (optional)

This is how the different parts are arranged:

```
[label:] mnemonic [operands] [;comment]
```

Let's explore each part separately, beginning with the *label* field.

#### **Label**

A *label* is an identifier that acts as a place marker for instructions and data. A label placed just before an instruction implies the instruction's address. Similarly, a label placed just before a variable implies the variable's address. There are two types of labels: Data labels and Code labels.

A *data label* identifies the location of a variable, providing a convenient way to reference the variable in code. The following, for example, defines a variable named `count`:

```
count  DWORD 100
```

The assembler assigns a numeric address to each label. It is possible to define multiple data items following a label. In the following example, `array` defines the location of the first number (1024). The other numbers following in memory immediately afterward:

```
array  DWORD 1024, 2048
        DWORD 4096, 8192
```

Variables will be explained in Section 3.4.2, and the `MOV` instruction will be explained in Section 4.1.4.

A label in the code area of a program (where instructions are located) must end with a colon (`:`) character. Code labels are used as targets of jumping and looping instructions. For example, the following `JMP` (jump) instruction transfers control to the location marked by the label named **target**, creating a loop:

```
target:
    mov  ax,bx
    ...
    jmp  target
```

A code label can share the same line with an instruction, or it can be on a line by itself:

```
L1: mov  ax,bx
L2:
```

Label names follow the same rules we described for identifiers in Section 3.1.8. You can use the same code label more than once in a program as long as each label is unique within its enclosing procedure. We will show how to create procedures in Chapter 5.

### Instruction Mnemonic

An *instruction mnemonic* is a short word that identifies an instruction. In English, a *mnemonic* is a device that assists memory. Similarly, assembly language instruction mnemonics such as `mov`, `add`, and `sub` provide hints about the type of operation they perform. Following are examples of instruction mnemonics:

Mnemonic	Description
MOV	Move (assign) one value to another
ADD	Add two values
SUB	Subtract one value from another
MUL	Multiply two values
JMP	Jump to a new location
CALL	Call a procedure

### Operands

An operand is a value that is used for input or output for an instruction. Assembly language instructions can have between zero and three operands, each of which can be a register, memory operand, integer expression, or input–output port. We discussed register names in Chapter 2, and we discussed integer expressions in Section 3.1.2. There are different ways to create memory operands—using variable names, registers surrounded by brackets, for example. We will go into more details about that later. A variable name implies the address of the variable and instructs the computer to reference the contents of memory at the given address. The following table contains several sample operands:

Example	Operand Type
96	<i>Integer literal</i>
2 + 4	Integer expression
eax	Register
count	Memory

Let's look at examples of assembly language instructions having varying numbers of operands. The `STC` instruction, for example, has no operands:

```
stc                                ; set Carry flag
```

The `INC` instruction has one operand:

```
inc eax                            ; add 1 to EAX
```

The `MOV` instruction has two operands:

```
mov count, ebx                    ; move EBX to count
```

There is a natural ordering of operands. When instructions have multiple operands, the first one is typically called the destination operand. The second operand is usually called the *source operand*. In general, the contents of the destination operand are modified by the instruction. In a `MOV` instruction, for example, data is copied from the source to the destination.



The IMUL instruction has three operands, in which the first operand is the destination, and the following two operands are source operands, which are multiplied together:

```
imul eax,ebx,5
```

In this case, EBX is multiplied by 5, and the product is stored in the EAX register.

### **Comments**

Comments are an important way for the writer of a program to communicate information about the program's design to a person reading the source code. The following information is typically included at the top of a program listing:

- Description of the program's purpose
- Names of persons who created and/or revised the program
- Program creation and revision dates
- Technical notes about the program's implementation

Comments can be specified in two ways:

- Single-line comments, beginning with a semicolon character (;). All characters following the semicolon on the same line are ignored by the assembler.
- Block comments, beginning with the COMMENT directive and a user-specified symbol. All subsequent lines of text are ignored by the assembler until the same user-specified symbol appears. Here is an example:

```
COMMENT !
    This line is a comment.
    This line is also a comment.
!
```

We can also use any other symbol, as long as it does not appear within the comment lines:

```
COMMENT &
    This line is a comment.
    This line is also a comment.
&
```

Of course, you should provide comments throughout a program, particularly where the intent of your code is not obvious.

### **The NOP (No Operation) Instruction**

The safest (and the most useless) instruction is NOP (no operation). It takes up 1 byte of program storage and doesn't do any work. It is sometimes used by compilers and assemblers to align code to efficient address boundaries. In the following example, the first MOV instruction generates three machine code bytes. The NOP instruction aligns the address of the third instruction to a doubleword boundary (even multiple of 4):

```
00000000 66 8B C3    mov ax,bx
00000003 90          nop          ; align next instruction
00000004 8B D1      mov edx,ecx
```

x86 processors are designed to load code and data more quickly from even doubleword addresses.

### 3.1.11 Section Review

1. Using the value  $-35$ , write it as an integer literal in decimal, hexadecimal, octal, and binary formats that are consistent with MASM syntax.
2. (*Yes/No*): Is `A5h` a valid hexadecimal literal?
3. (*Yes/No*): Does the multiplication operator (`*`) have a higher precedence than the division operator (`/`) in integer expressions?
4. Create a single integer expression that uses all the operators from Section 3.1.2. Calculate the value of the expression.
5. Write the real number  $-6.2 \times 10^4$  as a real number literal using MASM syntax.
6. (*Yes/No*): Must string literals be enclosed in single quotes?
7. Reserved words can be instruction mnemonics, attributes, operators, predefined symbols, and \_\_\_\_\_.
8. What is the maximum length of an identifier?

## 3.2 Example: Adding and Subtracting Integers

### 3.2.1 The *AddTwo* Program

Let's revisit the *AddTwo* program we showed at the beginning of this chapter and add the necessary declarations to make it a fully operational program. Remember, the line numbers are not really part of the program:

```
1: ; AddTwo.asm - adds two 32-bit integers
2: ; Chapter 3 example
3:
4: .386
5: .model flat,stdcall
6: .stack 4096
7: ExitProcess PROTO, dwExitCode:DWORD
8:
9: .code
10: main PROC
11:     mov     eax,5       ; move 5 to the eax register
12:     add     eax,6       ; add 6 to the eax register
13:
14:     INVOKE ExitProcess,0
15: main ENDP
16: END main
```

Line 4 contains the `.386` directive, which identifies this as a 32-bit program that can access 32-bit registers and addresses. Line 5 selects the program's memory model (*flat*), and identifies the calling convention (named *stdcall*) for procedures. We use this because 32-bit Windows services require the *stdcall* convention to be used. (Chapter 8 explains how *stdcall* works.) Line 6 sets aside 4096 bytes of storage for the runtime stack, which every program must have.

Line 7 declares a prototype for the **ExitProcess** function, which is a standard Windows service. A *prototype* consists of the function name, the **PROTO** keyword, a comma, and a list of input parameters. The input parameter for `ExitProcess` is named **dwExitCode**. You might think of it as a return value passed back to the Windows operating system. A return value of zero usually means our program was successful. Any other integer value generally indicates an error code number. So, you can think of your assembly programs as subroutines, or processes, which are called by the operating system. When your program is ready to finish, it calls `ExitProcess` and returns an integer that tells the operating system that your program worked just fine.

**More Info:** You might be wondering why the operating system wants to know if your program completed successfully. Here's why: system administrators often create script files that execute a number of programs in sequence. At each point in the script, they need to know if the most recently executed program has failed, so they can exit the script if necessary. It often goes something like the script shown below, where *ErrorLevel 1* indicates that the process return code from the previous step was greater than or equal to 1:

```
call program_1
if ErrorLevel 1 goto FailedLabel
call program_2
if ErrorLevel 1 goto FailedLabel
:SuccessLabel
Echo Great, everything worked!
```

Let's return to our listing of the `AddTwo` program. Line 16 uses the **end** directive to mark the last line to be assembled, and it identifies the program entry point (`main`). The label `main` was declared on Line 10, and it marks the address at which the program will begin to execute.

**Tip:** Visual Studio's syntax highlighting and wavy lines under keywords are not consistent when displaying assembly language code. If you want to disable it, here's how: Choose *Options* from the Tools menu, select *Text Editor*, select *C/C++*, select *Advanced*, and under the *Intellisense* heading, set *Disable Squiggles* to True. Click *OK* to close the Options window. Also, remember that MASM is not case-sensitive, so you can capitalize or not capitalize keywords in any combination.

### A Review of the Assembler Directives

Let's review some of the most important assembler directives we used in the sample program. First, the `.MODEL` directive tells the assembler which memory model to use:

```
.model flat,stdcall
```

In 32-bit programs, we always use the flat memory model, which is associated with the processor's protected mode. We talked about protected mode in Chapter 2. The `stdcall` keyword tells the assembler how to manage the runtime stack when procedures are called. That's a complicated subject that we will address in Chapter 8. Next, the `.STACK` directive tells the assembler how many bytes of memory to reserve for the program's runtime stack:

```
.stack 4096
```

The value 4096 is probably more than we will ever use, but it happens to correspond to the size of a memory page in the processor's system for managing memory. All modern programs use a stack when calling subroutines—first, to hold passed parameters, and second, to hold the address of the code that called the function. The CPU uses this address to return when the function call finishes, back to the spot where the function was called. In addition, the runtime stack can hold local variables, that is, variables declared inside a function.

The `.CODE` directive marks the beginning of the code area of a program, the area that contains executable instructions. Usually the next line after `.CODE` is the declaration of the program's entry point, and by convention, it is usually a procedure named **main**. The entry point of a program is the location of the very first instruction the program will execute. We used the following lines to convey this information:

```
.code  
main PROC
```

The `ENDP` directive marks the end of a procedure. Our program had a procedure named `main`, so the `endp` must use the same name:

```
main ENDP
```

Finally, the `END` directive marks the end of the program, and references the program entry point:

```
END main
```

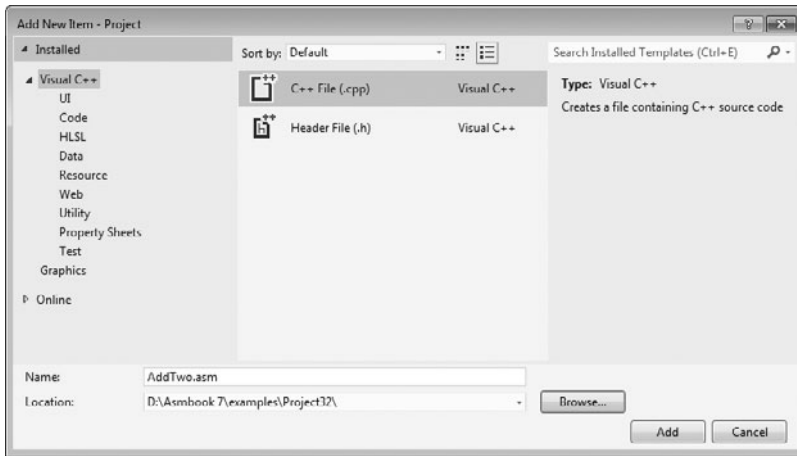
If you add any more lines to a program after the `END` directive, they will be ignored by the assembler. You can put anything there—program comments, copies of your code, etc.—it doesn't matter.

### 3.2.2 Running and Debugging the AddTwo Program

You can easily use Visual Studio to edit, build, and run assembly language programs. The book's example files directory has a folder named *Project32* that contains a Visual Studio 2012 Windows Console project that has been configured for 32-bit assembly language programming. (Another folder named *Project64* is configured for 64-bit assembly.) The following instructions, modeled after Visual Studio 2012, tell you how to open the sample project and create the AddTwo program:

1. Open the *Project32* folder and double-click the file named *Project.sln*. This should launch the latest version of Visual Studio installed on your computer.
2. Open the Solution Explorer window inside Visual Studio. It should already be visible, but you can always make it visible by selecting *Solution Explorer* from the *View* menu.
3. Right-click the project name in Solution Explorer, select *Add* from the context menu, and then select *New Item* from the popup menu.
4. In the *Add New File* dialog window (see Figure 3-1), name the file *AddTwo.asm*, and choose an appropriate disk folder for the file by filling in the *Location* entry.
5. Click the *Add* button to save the file.

FIGURE 3-1 Adding a new source code file to a Visual Studio project.



6. Type in the program's source code, shown here. The capitalization of keywords here is not required:

```
; AddTwo.asm - adds two 32-bit integers.

.386
.model flat,stdcall
.stack 4096
ExitProcess PROTO,dwExitCode:DWORD

.code
main PROC
    mov  eax,5
    add  eax,6

    INVOKE ExitProcess,0
main ENDP
END main
```

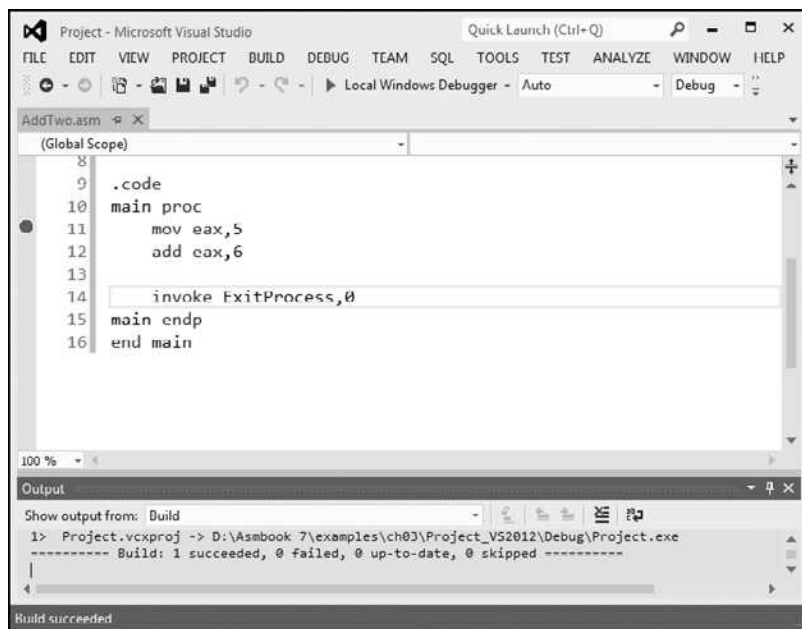
7. Select *Build Project* from the Project menu, and look for error messages at the bottom of the Visual Studio workspace. It's called the *Error List* window. Figure 3-2 shows our sample program after it has been opened and assembled. Notice that the status line on the bottom of the window says *Build succeeded* when there are no errors.

### Debugging Demonstration

We will demonstrate a sample debugging session for the AddTwo program. We have not shown you a way to display variable values directly in the console window yet, so we will run the program in a debugging session. We will use Visual Studio 2012 for this demonstration, but it would work just as well in any version of Visual Studio from 2008 onward.

One way to run and debug a program is to, select *Step Over* from the Debug menu. Depending on how Visual Studio was configured, either the F10 function key or the Shift+F8 keys will execute the *Step Over* command.

FIGURE 3-2 Building the Visual Studio project.



Another way to start a debugging session is to set a breakpoint on a program statement by clicking the mouse in the vertical gray bar just to the left of the code window. A large red dot will mark the breakpoint location. Then you can run the program by selecting *Start Debugging* from the Debug menu.

**Tip:** If you try to set a breakpoint on a non-executable line, Visual Studio will just move the breakpoint forward to the next executable line when you run the program.

Figure 3-3 shows the program at the start of a debugging session. A breakpoint was set on Line 11, the first MOV instruction, and the debugger has paused on that line. The line has not executed yet. When the debugger is active, the bottom status line of the Visual Studio window turns orange. When you stop the debugger and return to edit mode, the status line turns blue. The visual cue is helpful because you cannot edit or save a program while the debugger is running.

Figure 3-4 shows the debugger after the user has stepped through lines 11 and 12, and is paused on line 14. By hovering the mouse over the EAX register name, we can see its current contents (11). We can then finish the program execution by clicking the *Continue* button on the toolbar, or by clicking the red *Stop Debugging* button (on the right side of the toolbar).

### Customizing the Debugging Interface

You can customize the debugging interface while it is running. For example, you might want to display the CPU registers; to do this, select *Windows* from the Debug menu, and then select *Registers*. Figure 3-5 shows the same debugging session we used just now, with the *Registers* window visible. We also closed some other nonessential windows. The value shown in EAX, 0000000B, is the hexadecimal representation of 11 decimal. We've drawn an arrow in the

FIGURE 3-3 Debugger paused at a breakpoint.

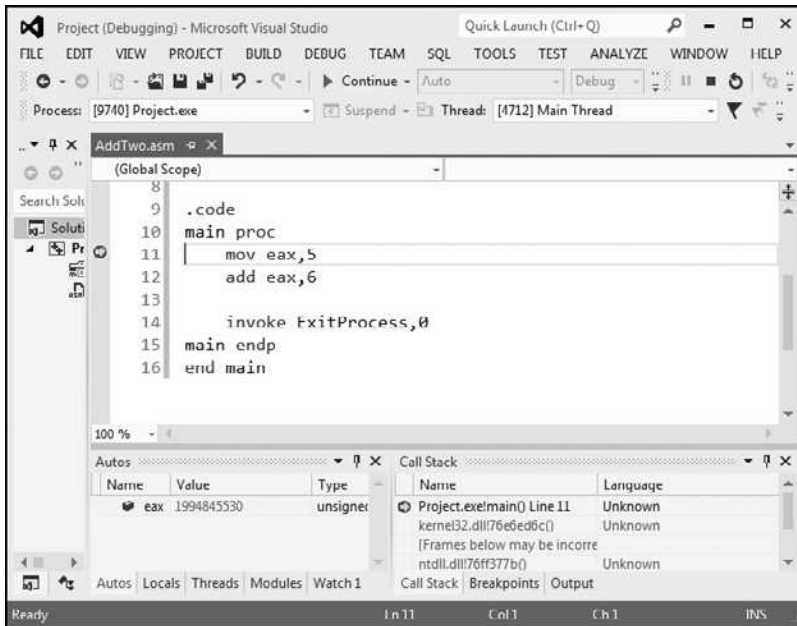


FIGURE 3-4 After executing lines 11 and 12 in the debugger.

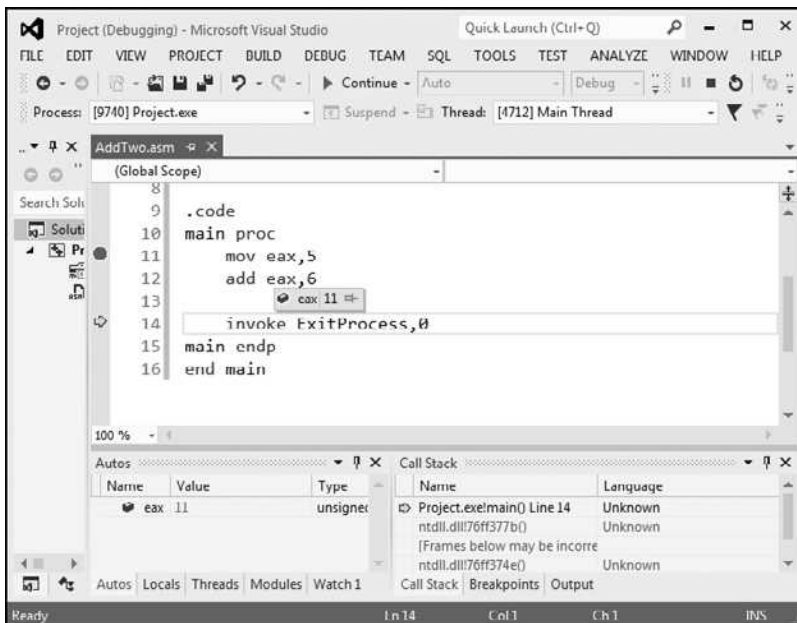
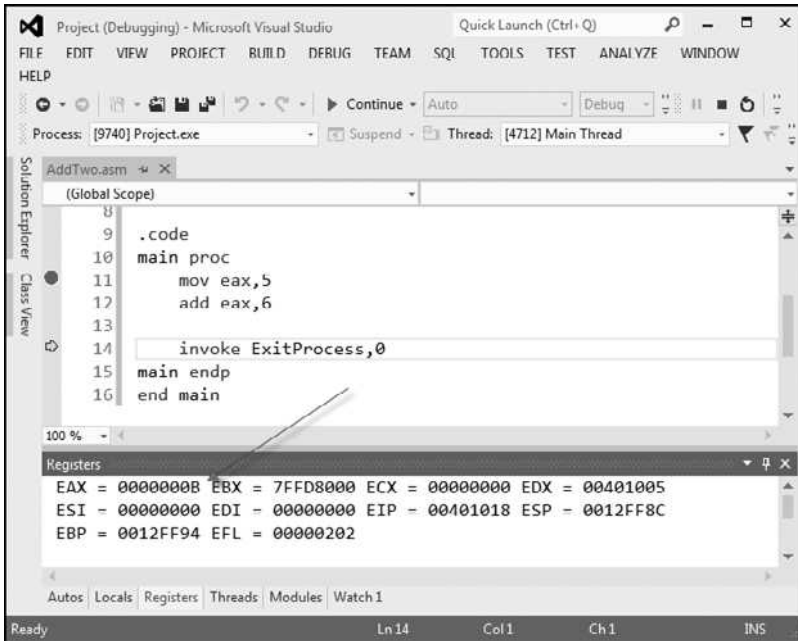
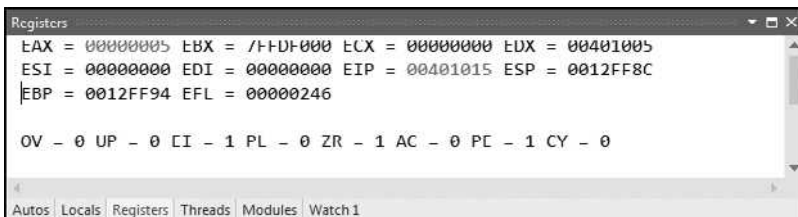


FIGURE 3-5 Adding the *Registers* window to a debugging session.

figure, pointing to the value. In the *Registers* window, the EFL register contains all the status flag settings (Zero, Carry, Overflow, etc.). If you right-click the *Registers* window and select *Flags* from the popup menu, the window will display the individual flag values. Figure 3-6 shows an example, where the flag values from left to right are: OV (overflow flag), UP (direction flag), EI (interrupt flag), PL (sign flag), ZR (zero flag), AC (auxiliary carry), PE (parity flag), and CY (carry flag). The precise meaning of these flags will be explained in Chapter 4.

One of the great things about the *Registers* window is that as you step through a program, any register whose value is changed by the current instruction will turn red. Although we cannot show it on the printed page (which is black and white), the red highlighting really jumps out at you, to let you know how your program is affecting the registers.

**Tip:** The book's web site ([asmirvine.com](http://asmirvine.com)) has tutorials that show you how to assemble and debug assembly language programs.

FIGURE 3-6 Showing the CPU status flags in the *Registers* window.



When you run an assembly language program inside Visual Studio, it launches inside a console window. This is the same window you see when you run the program named *cmd.exe* from the Windows *Start* menu. Alternatively, you could open up a command prompt in the project's *Debug\Bin* folder and run the application directly from the command line. If you did this, you would only see the program's output, which consists of text written to the console window. Look for an executable filename having the same name as your Visual Studio project.

### 3.2.3 Program Template

Assembly language programs have a simple structure, with small variations. When you begin a new program, it helps to start with an empty shell program with all basic elements in place. You can avoid redundant typing by filling in the missing parts and saving the file under a new name. The following program (*Template.asm*) can easily be customized. Note that comments have been inserted, marking the points where your own code should be added. Capitalization of keywords is optional:

```
; Program template (Template.asm)

.386
.model flat,stdcall
.stack 4096
ExitProcess PROTO, dwExitCode:DWORD

.data
    ; declare variables here
.code
main PROC
    ; write your code here

    INVOKE ExitProcess,0
main ENDP
END main
```

**Use Comments** It's a very good idea to include a program description, the name of the program's author, creation date, and information about subsequent modifications. Documentation of this kind is useful to anyone who reads the program listing (including you, months or years from now). Many programmers have discovered, years after writing a program, that they must become reacquainted with their own code before they can modify it. If you're taking a programming course, your instructor may insist on additional information.

### 3.2.4 Section Review

1. In the *AddTwo* program, what is the meaning of the *INCLUDE* directive?
2. In the *AddTwo* program, what does the *.CODE* directive identify?
3. What are the names of the two segments in the *AddTwo* program?
4. In the *AddTwo* program, which register holds the sum?
5. In the *AddTwo* program, which statement halts the program?

### 3.3 Assembling, Linking, and Running Programs

A source program written in assembly language cannot be executed directly on its target computer. It must be translated, or *assembled* into executable code. In fact, an assembler is very similar to a *compiler*, the type of program you would use to translate a C++ or Java program into executable code.

The assembler produces a file containing machine language called an *object file*. This file isn't quite ready to execute. It must be passed to another program called a *linker*, which in turn produces an *executable file*. This file is ready to execute from the operating system's command prompt.

#### 3.3.1 The Assemble-Link-Execute Cycle

The process of editing, assembling, linking, and executing assembly language programs is summarized in Figure 3-7. Following is a detailed description of each step.

**Step 1:** A programmer uses a **text editor** to create an ASCII text file named the *source file*.

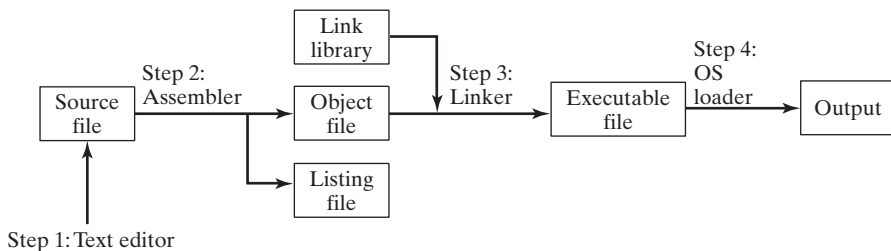
**Step 2:** The **assembler** reads the source file and produces an *object file*, a machine-language translation of the program. Optionally, it produces a *listing file*. If any errors occur, the programmer must return to Step 1 and fix the program.

**Step 3:** The **linker** reads the object file and checks to see if the program contains any calls to procedures in a link library. The **linker** copies any required procedures from the link library, combines them with the object file, and produces the *executable file*.

**Step 4:** The operating system **loader** utility reads the executable file into memory and branches the CPU to the program's starting address, and the program begins to execute.

See the topic "Getting Started" on the author's Web site ([www.asmirvine.com](http://www.asmirvine.com)) for detailed instructions on assembling, linking, and running assembly language programs using Microsoft Visual Studio.

FIGURE 3-7 Assemble-Link-Execute cycle.



#### 3.3.2 Listing File

A *listing file* contains a copy of the program's source code, with line numbers, the numeric address of each instruction, the machine code bytes of each instruction (in hexadecimal), and a symbol table. The symbol table contains the names of all program identifiers, segments, and related information. Advanced programmers sometimes use the listing file to get detailed

information about the program. Figure 3-8 shows a partial listing file for the *AddTwo* program. Let's examine it in more detail. Lines 1–7 contain no executable code, so they are copied directly from the source file without changes. Line 9 shows that the beginning of the code segment is located at address 00000000 (in a 32-bit program, addresses display as 8 hexadecimal digits). This address is relative to the beginning of the program's memory footprint, but it will be converted into an absolute memory address when the program is loaded into memory. When that happens, the program might start at an address such as 00040000h.

FIGURE 3–8 Excerpt from the *AddTwo* source listing file.

```

1:      ; AddTwo.asm - adds two 32-bit integers.
2:      ; Chapter 3 example
3:
4:      .386
5:      .model flat,stdcall
6:      .stack 4096
7:      ExitProcess PROTO,dwExitCode:DWORD
8:
9:      00000000          .code
10:     00000000          main PROC
11:     00000000 B8 00000005      mov  eax,5
12:     00000005 83 C0 06          add  eax,6
13:
14:                                     invoke ExitProcess,0
15:     00000008 6A 00          push +0000000000h
16:     0000000A E8 00000000 E      call  ExitProcess
17:     0000000F          main ENDP
18:     0000000F          END main

```

Lines 10 and 11 also show the same starting address of 00000000, because the first executable statement is the MOV instruction on line 11. Notice on line 11 that several hexadecimal bytes appear between the address and the source code. These bytes (B8 00000005) represent the machine code instruction (B8), and the constant 32-bit value (00000005) that is assigned to EAX by the instruction:

```
11: 00000000 B8 00000005 mov eax,5
```

The value B8 is also known as an *operation code* (or just *opcode*), because it represents the specific machine instruction to move a 32-bit integer into the **eax** register. In Chapter 12 we explain the structure of x86 machine instructions in great detail.

Line 12 also contains an executable instruction, starting at offset 00000005. That offset is a distance of 5 bytes from the beginning of the program. Perhaps you can guess how that offset was calculated.

Line 14 contains the **invoke** directive. Notice how lines 15 and 16 seem to have been inserted into our code. This is because the INVOKE directive causes the assembler to generate the PUSH and CALL statements shown on lines 15 and 16. In Chapter 5 we will show how to use PUSH and CALL.

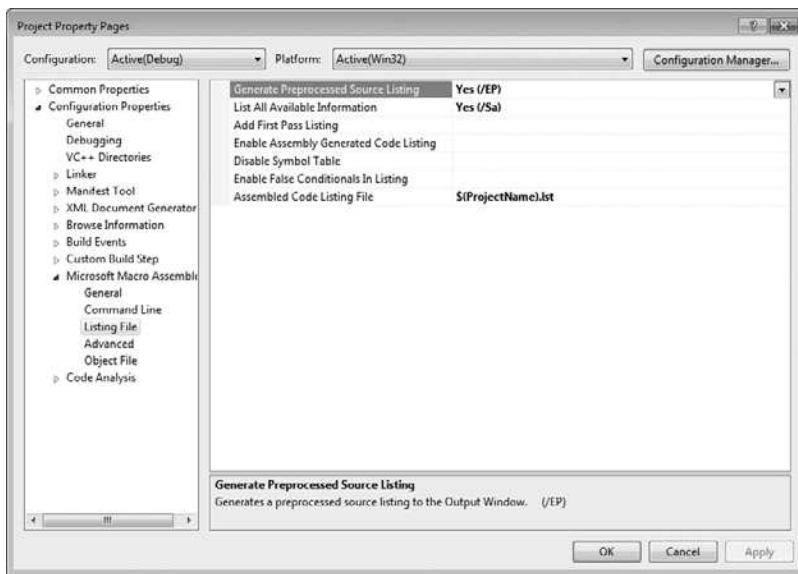
The sample listing file in Figure 3-8 shows that the machine instructions are loaded into memory as a sequence of integer values, expressed here in hexadecimal: B8, 00000005, 83, C0,

06, 6A, 00, EB, 00000000. The number of digits in each number indicates the number of bits: a 2-digit number is 8 bits, a 4-digit number is 16 bits, an 8-digit number is 32 bits, and so on. So our machine instructions are exactly 15 bytes long (two 4-byte values and seven 1-byte values).

Whenever you want to make sure the assembler is generating the correct machine code bytes based on your program, the listing file is your best resource. It is also a great teaching tool if you're just learning how machine code instructions are generated.

**Tip:** To tell Visual Studio to generate a listing file, do the following when a project is open: Select *Properties* from the Project menu. Under *Configuration Properties*, select *Microsoft Macro Assembler*. Then select *Listing File*. In the dialog window, set *Generate Preprocessed Source Listing* to *Yes*, and set *List All Available Information* to *Yes*. The dialog window is shown in Figure 3-9.

FIGURE 3-9 Configuring Visual Studio to generate a listing file.



The rest of the listing file contains a list of structures and unions, as well as procedures, parameters, and local variables. We will not show those elements here, but we will discuss them in later chapters.

### 3.3.3 Section Review

1. What types of files are produced by the assembler?
2. (*True/False*): The linker extracts assembled procedures from the link library and inserts them in the executable program.
3. (*True/False*): When a program's source code is modified, it must be assembled and linked again before it can be executed with the changes.
4. Which operating system component reads and executes programs?
5. What types of files are produced by the linker?

## 3.4 Defining Data

### 3.4.1 Intrinsic Data Types

The assembler recognizes a basic set of *intrinsic data types*, which describe types in terms of their size (byte, word, doubleword, and so on), whether they are signed, and whether they are integers or reals. There's a fair amount of overlap in these types—for example, the DWORD type (32-bit, unsigned integer) is interchangeable with the SDWORD type (32-bit, signed integer). You might say that programmers use SDWORD to communicate to readers that a value will contain a sign, but there is no enforcement by the assembler. The assembler only evaluates the sizes of operands. So, for example, you can only assign variables of type DWORD, SDWORD, or REAL4 to a 32-bit integer. Table 3-2 contains a list of all the intrinsic data types. The notation IEEE in some of the table entries refers to standard real number formats published by the IEEE Computer Society.

### 3.4.2 Data Definition Statement

A *data definition statement* sets aside storage in memory for a variable, with an optional name. Data definition statements create variables based on intrinsic data types (Table 3-2). A data definition has the following syntax:

```
[name] directive initializer [,initializer]...
```

Table 3-2 Intrinsic Data Types.

Type	Usage
BYTE	8-bit unsigned integer. B stands for byte
SBYTE	8-bit signed integer. S stands for signed
WORD	16-bit unsigned integer
SWORD	16-bit signed integer
DWORD	32-bit unsigned integer. D stands for double
SDWORD	32-bit signed integer. SD stands for signed double
FWORD	48-bit integer (Far pointer in protected mode)
QWORD	64-bit integer. Q stands for quad
TBYTE	80-bit (10-byte) integer. T stands for Ten-byte
REAL4	32-bit (4-byte) IEEE short real
REAL8	64-bit (8-byte) IEEE long real
REAL10	80-bit (10-byte) IEEE extended real

This is an example of a data definition statement:

```
count DWORD 12345
```

**Name** The optional name assigned to a variable must conform to the rules for identifiers (Section 3.1.8).

**Directive** The directive in a data definition statement can be BYTE, WORD, DWORD, SBYTE, SWORD, or any of the types listed in Table 3-2. In addition, it can be any of the legacy data definition directives shown in Table 3-3.

TABLE 3-3 Legacy Data Directives.

Directive	Usage
DB	8-bit integer
DW	16-bit integer
DD	32-bit integer or real
DQ	64-bit integer or real
DT	define 80-bit (10-byte) integer

**Initializer** At least one *initializer* is required in a data definition, even if it is zero. Additional initializers, if any, are separated by commas. For integer data types, *initializer* is an integer literal or integer expression matching the size of the variable's type, such as BYTE or WORD. If you prefer to leave the variable uninitialized (assigned a random value), the ? symbol can be used as the initializer. All initializers, regardless of their format, are converted to binary data by the assembler. Initializers such as 00110010b, 32h, and 50d all have the same binary value.

### 3.4.3 Adding a Variable to the AddTwo Program

Let's create a new version of the *AddTwo* program we introduced at the beginning of this chapter, which we will now call *AddTwoSum*. This version introduces a variable named **sum**, which appears in the complete program listing:

```
1: ; AddTwoSum.asm - Chapter 3 example
2:
3:     .386
4:     .model flat,stdcall
5:     .stack 4096
6:     ExitProcess PROTO, dwExitCode:DWORD
7:
8:     .data
9:     sum DWORD 0
10:
11:    .code
12:    main PROC
13:        mov eax,5
```

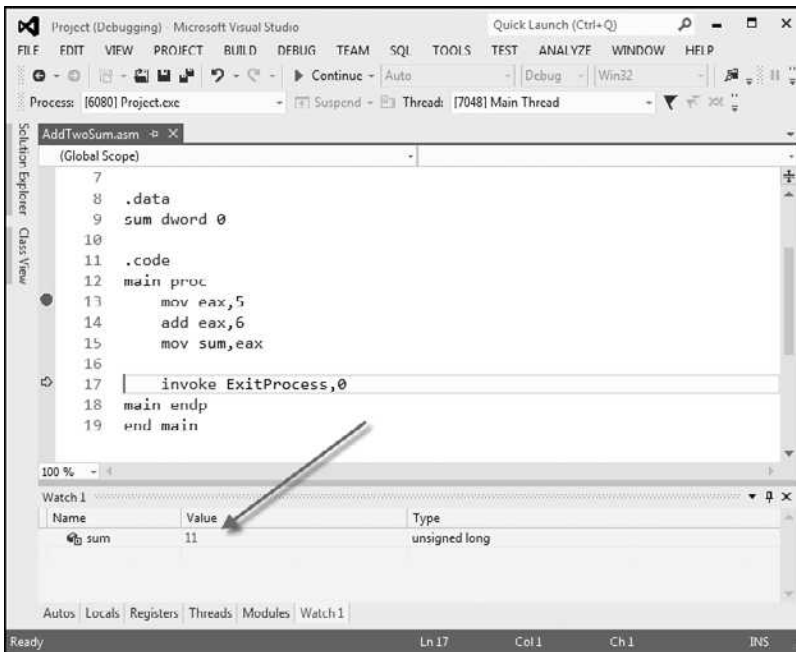
```

14:      add eax,6
15:      mov sum,eax
16:
17:      INVOKE ExitProcess,0
18:      main ENDP
19:      END main

```

You can run this in the debugger by setting a breakpoint on line 13 and stepping through the program one line at a time. After executing line 15, hover the mouse over the **sum** variable to see its value. Or, you can open a Watch window. To do that, select *Windows* from the Debug menu (during a debugging session), select *Watch*, and select one of the four available choices (*Watch1*, *Watch2*, *Watch3*, or *Watch4*). Then, highlight the **sum** variable with the mouse and drag it into the Watch window. Figure 3-10 shows a sample, with a large arrow pointing at the current value of **sum** after executing line 15.

FIGURE 3-10 Using a *Watch* window in a debugging session.



### 3.4.4 Defining BYTE and SBYTE Data

The **BYTE** (define byte) and **SBYTE** (define signed byte) directives allocate storage for one or more unsigned or signed values. Each initializer must fit into 8 bits of storage. For example,

```

value1 BYTE 'A'           ; character literal
value2 BYTE 0             ; smallest unsigned byte
value3 BYTE 255          ; largest unsigned byte
value4 SBYTE -128        ; smallest signed byte
value5 SBYTE +127        ; largest signed byte

```

A question mark (?) initializer leaves the variable uninitialized, implying that it will be assigned a value at runtime:

```
value6 BYTE ?
```

The optional name is a label marking the variable's offset from the beginning of its enclosing segment. For example, if **value1** is located at offset 0000 in the data segment and consumes one byte of storage, **value2** is automatically located at offset 0001:

```
value1 BYTE 10h
value2 BYTE 20h
```

The DB directive can also define an 8-bit variable, signed or unsigned:

```
val1 DB 255 ; unsigned byte
val2 DB -128 ; signed byte
```

### Multiple Initializers

If multiple initializers are used in the same data definition, its label refers only to the offset of the first initializer. In the following example, assume **list** is located at offset 0000. If so, the value 10 is at offset 0000, 20 is at offset 0001, 30 is at offset 0002, and 40 is at offset 0003:

```
list BYTE 10,20,30,40
```

Figure 3-11 shows **list** as a sequence of bytes, each with its own offset.

FIGURE 3-11 Memory layout of a byte sequence.

Offset	Value
0000:	10
0001:	20
0002:	30
0003:	40

Not all data definitions require labels. To continue the array of bytes begun with **list**, for example, we can define additional bytes on the next lines:

```
list BYTE 10,20,30,40
       BYTE 50,60,70,80
       BYTE 81,82,83,84
```

Within a single data definition, its initializers can use different radixes. Character and string literals can be freely mixed. In the following example, **list1** and **list2** have the same contents:

```
list1 BYTE 10, 32, 41h, 00100010b
list2 BYTE 0Ah, 20h, 'A', 22h
```

### Defining Strings

To define a string of characters, enclose them in single or double quotation marks. The most common type of string ends with a null byte (containing 0). Called a *null-terminated* string, strings of this type are used in many programming languages:



```
greeting1 BYTE "Good afternoon",0
greeting2 BYTE 'Good night',0
```

Each character uses a byte of storage. Strings are an exception to the rule that byte values must be separated by commas. Without that exception, **greeting1** would have to be defined as

```
greeting1 BYTE 'G','o','o','d'....etc.
```

which would be exceedingly tedious. A string can be divided between multiple lines without having to supply a label for each line:

```
greeting1 BYTE "Welcome to the Encryption Demo program "
             BYTE "created by Kip Irvine.",0dh,0ah
             BYTE "If you wish to modify this program, please "
             BYTE "send me a copy.",0dh,0ah,0
```

The hexadecimal codes 0Dh and 0Ah are alternately called CR/LF (carriage-return line-feed) or *end-of-line characters*. When written to standard output, they move the cursor to the left column of the line following the current line.

The line continuation character (\) concatenates two source code lines into a single statement. It must be the last character on the line. The following statements are equivalent:

```
greeting1 BYTE "Welcome to the Encryption Demo program "
```

and

```
greeting1 \
BYTE "Welcome to the Encryption Demo program "
```

### DUP Operator

The *DUP operator* allocates storage for multiple data items, using a integer expression as a counter. It is particularly useful when allocating space for a string or array, and can be used with initialized or uninitialized data:

```
BYTE 20 DUP(0)           ; 20 bytes, all equal to zero
BYTE 20 DUP(?)          ; 20 bytes, uninitialized
BYTE 4  DUP("STACK")    ; 20 bytes: "STACKSTACKSTACKSTACK"
```

### 3.4.5 Defining WORD and SWORD Data

The WORD (define word) and SWORD (define signed word) directives create storage for one or more 16-bit integers:

```
word1 WORD 65535         ; largest unsigned value
word2 SWORD -32768      ; smallest signed value
word3 WORD ?           ; uninitialized, unsigned
```

The legacy DW directive can also be used:

```
val1 DW 65535           ; unsigned
val2 DW -32768         ; signed
```

**Array of 16-Bit Words** Create an array of words by listing the elements or using the DUP operator. The following array contains a list of values:

```
myList WORD 1,2,3,4,5
```

Figure 3-12 shows a diagram of the array in memory, assuming **myList** starts at offset 0000. The addresses increment by 2 because each value occupies 2 bytes.

FIGURE 3-12 Memory layout, 16-bit word array.

Offset	Value
0000:	1
0002:	2
0004:	3
0006:	4
0008:	5

The DUP operator provides a convenient way to declare an array:

```
array WORD 5 DUP(?)           ; 5 values, uninitialized
```

### 3.4.6 Defining DWORD and SDWORD Data

The DWORD directive (define doubleword) and SDWORD directive (define signed doubleword) allocate storage for one or more 32-bit integers:

```
val1 DWORD 12345678h          ; unsigned
val2 SDWORD -2147483648        ; signed
val3 DWORD 20 DUP(?)           ; unsigned array
```

The legacy DD directive can also be used to define doubleword data.

```
val1 DD 12345678h              ; unsigned
val2 DD -2147483648            ; signed
```

The DWORD can be used to declare a variable that contains the 32-bit offset of another variable. Below, **pVal** contains the offset of **val3**:

```
pVal DWORD val3
```

*Array of 32-Bit Doublewords* Let's create an array of doublewords by explicitly initializing each value:

```
myList DWORD 1,2,3,4,5
```

Figure 3-13 shows a diagram of this array in memory, assuming **myList** starts at offset 0000. The offsets increment by 4.

### 3.4.7 Defining QWORD Data

The QWORD (define quadword) directive allocates storage for 64-bit (8-byte) values:

```
quad1 QWORD 1234567812345678h
```

The legacy DQ directive can also be used to define quadword data:

```
quad1 DQ 1234567812345678h
```

FIGURE 3-13 Memory layout, 32-bit doubleword array.

Offset	Value
0000:	1
0004:	2
0008:	3
000C:	4
0010:	5

### 3.4.8 Defining Packed BCD (TBYTE) Data

Intel stores a packed *binary coded decimal* (BCD) integers in a 10-byte package. Each byte (except the highest) contains two decimal digits. In the lower 9 storage bytes, each half-byte holds a single decimal digit. In the highest byte, the highest bit indicates the number's sign. If the highest byte equals 80h, the number is negative; if the highest byte equals 00h, the number is positive. The integer range is  $-999,999,999,999,999,999$  to  $+999,999,999,999,999,999$ .

*Example* The hexadecimal storage bytes for positive and negative decimal 1234 are shown in the following table, from the least significant byte to the most significant byte:

Decimal Value	Storage Bytes
+1234	34 12 00 00 00 00 00 00 00 00
-1234	34 12 00 00 00 00 00 00 80 00

MASM uses the TBYTE directive to declare packed BCD variables. Constant initializers must be in hexadecimal because the assembler does not automatically translate decimal initializers to BCD. The following two examples demonstrate both valid and invalid ways of representing decimal  $-1234$ :

```
intVal TBYTE 8000000000000001234h      ; valid
intVal TBYTE -1234                      ; invalid
```

The reason the second example is invalid is that MASM encodes the constant as a binary integer rather than a packed BCD integer.

If you want to encode a real number as packed BCD, you can first load it onto the floating-point register stack with the FLD instruction and then use the FBSTP instruction to convert it to packed BCD. This instruction rounds the value to the nearest integer:

```
.data
posVal REAL8 1.5
bcdVal TBYTE ?

.code
fld posVal          ; load onto floating-point stack
fbstp bcdVal       ; rounds up to 2 as packed BCD
```

If **posVal** were equal to 1.5, the resulting BCD value would be 2. In Chapter 7, you will learn how to do arithmetic with packed BCD values.

### 3.4.9 Defining Floating-Point Types

REAL4 defines a 4-byte single-precision floating-point variable. REAL8 defines an 8-byte double-precision value, and REAL10 defines a 10-byte extended-precision value. Each requires one or more real constant initializers:

```
rVal1      REAL4  -1.2
rVal2      REAL8   3.2E-260
rVal3      REAL10  4.6E+4096
ShortArray REAL4   20 DUP(0.0)
```

Table 3-4 describes each of the standard real types in terms of their minimum number of significant digits and approximate range:

Table 3-4 Standard Real Number Types.

Data Type	Significant Digits	Approximate Range
Short real	6	$1.18 \times 10^{-38}$ to $3.40 \times 10^{38}$
Long real	15	$2.23 \times 10^{-308}$ to $1.79 \times 10^{308}$
Extended-precision real	19	$3.37 \times 10^{-4932}$ to $1.18 \times 10^{4932}$

The DD, DQ, and DT directives can define also real numbers:

```
rVal1 DD  -1.2                ; short real
rVal2 DQ  3.2E-260           ; long real
rVal3 DT  4.6E+4096         ; extended-precision real
```

**Clarification:** The MASM assembler includes data types such as **real4** and **real8**, suggesting that the values they represent are real numbers. More correctly, the values are floating-point numbers, which have a limited amount of precision and range. Mathematically, a real number has unlimited precision and size.

### 3.4.10 A Program That Adds Variables

The sample programs shown so far in this chapter added integers stored in registers. Now that you have some understanding of how to declare data, we will revise the same program by making it add the contents of three integer variables and store the sum in a fourth variable.

```
1: ; AddVariables.asm - Chapter 3 example
2:
3:   .386
4:   .model flat,stdcall
5:   .stack 4096
6:   ExitProcess PROTO, dwExitCode:DWORD
7:
8:   .data
9:   firstval  DWORD 20002000h
10:  secondval  DWORD 11111111h
```

```

11:   thirdval  DWORD 22222222h
12:   sum        DWORD 0
13:
14:   .code
15:   main PROC
16:       mov eax,firstval
17:       add eax,secondval
18:       add eax,thirdval
19:       mov sum,eax
20:
21:       INVOKE ExitProcess,0
22:   main ENDP
23:   END main

```

Notice that we have initialized three variables with nonzero values (lines 9–11). Lines 16–18 add the variables. The x86 instruction set does not let us add one variable directly to another, but it does allow a variable to be added to a register. That is why lines 16–17 use EAX as an accumulator:

```

16:   mov eax,firstval
17:   add eax,secondval

```

After line 17, EAX contains the sum of **firstval** and **secondval**. Next, line 18 adds **thirdval** to the sum in EAX:

```

18:   add eax,thirdval

```

Finally, on line 19, the sum is copied into the variable named **sum**:

```

19:   mov sum,eax

```

As an exercise, we encourage you to run this program in a debugging session and examine each of the registers after each instruction executes. The final sum should be hexadecimal 53335333.

**Tip:** During a debugging session, if you want to display the variable in hexadecimal, do the following: Hover the mouse over a variable or register for a second until a gray rectangle appears under the mouse. Right-click the rectangle and select *Hexadecimal Display* from the popup menu.

### 3.4.11 Little-Endian Order

x86 processors store and retrieve data from memory using *little-endian* order (low to high). The least significant byte is stored at the first memory address allocated for the data. The remaining bytes are stored in the next consecutive memory positions. Consider the doubleword 12345678h. If placed in memory at offset 0000, 78h would be stored in the first byte, 56h would be stored in the second byte, and the remaining bytes would be at offsets 0002 and 0003, as shown in Figure 3-14.

FIGURE 3-14 Little-endian representation of 12345678h.

0000:	78
0001:	56
0002:	34
0003:	12

Some other computer systems use *big-endian* order (high to low). Figure 3-15 shows an example of 12345678h stored in big-endian order at offset 0:

FIGURE 3-15 Big-endian representation of 12345678h.

0000:	12
0001:	34
0002:	56
0003:	78

### 3.4.12 Declaring Uninitialized Data

The `.DATA?` directive declares uninitialized data. When defining a large block of uninitialized data, the `.DATA?` directive reduces the size of a compiled program. For example, the following code is declared efficiently:

```
.data
smallArray DWORD 10 DUP(0)      ; 40 bytes
.data?
bigArray DWORD 5000 DUP(?)      ; 20,000 bytes, not initialized
```

The following code, on the other hand, produces a compiled program 20,000 bytes larger:

```
.data
smallArray DWORD 10 DUP(0)      ; 40 bytes
bigArray DWORD 5000 DUP(?)      ; 20,000 bytes
```

**Mixing Code and Data** The assembler lets you switch back and forth between code and data in your programs. You might, for example, want to declare a variable used only within a localized area of a program. The following example inserts a variable named **temp** between two code statements:

```
.code
mov eax, ebx
.data
temp DWORD ?
.code
mov temp, eax
. . .
```

Although the declaration of **temp** appears to interrupt the flow of executable instructions, MASM places **temp** in the data segment, separate from the segment holding compiled code. At the same time, intermixing `.code` and `.data` directives can cause a program to become hard to read.

### 3.4.13 Section Review

1. Create an uninitialized data declaration for a 16-bit signed integer.
2. Create an uninitialized data declaration for an 8-bit unsigned integer.
3. Create an uninitialized data declaration for an 8-bit signed integer.

4. Create an uninitialized data declaration for a 64-bit integer.
5. Which data type can hold a 32-bit signed integer?

## 3.5 Symbolic Constants

A *symbolic constant* (or *symbol definition*) is created by associating an identifier (a symbol) with an integer expression or some text. Symbols do not reserve storage. They are used only by the assembler when scanning a program, and they cannot change at runtime. The following table summarizes their differences:

	Symbol	Variable
Uses storage?	No	Yes
Value changes at runtime?	No	Yes

We will show how to use the equal-sign directive (=) to create symbols representing integer expressions. We will use the EQU and TEXTEQU directives to create symbols representing arbitrary text.

### 3.5.1 Equal-Sign Directive

The *equal-sign directive* associates a symbol name with an integer expression (see Section 3.1.3). The syntax is

```
name = expression
```

Ordinarily, *expression* is a 32-bit integer value. When a program is assembled, all occurrences of *name* are replaced by *expression* during the assembler's preprocessor step. Suppose the following statement occurs near the beginning of a source code file:

```
COUNT = 500
```

Further, suppose the following statement should be found in the file 10 lines later:

```
mov eax, COUNT
```

When the file is assembled, MASM will scan the source file and produce the corresponding code lines:

```
mov eax, 500
```

**Why Use Symbols?** We might have skipped the COUNT symbol entirely and simply coded the MOV instruction with the literal 500, but experience has shown that programs are easier to read and maintain if symbols are used. Suppose COUNT were used many times throughout a program. At a later time, we could easily redefine its value:

```
COUNT = 600
```

Assuming that the source file was assembled again, all instances of COUNT would be automatically replaced by the value 600.

**Current Location Counter** One of the most important symbols of all, shown as \$, is called the *current location counter*. For example, the following declaration declares a variable named **selfPtr** and initializes it with the variable's offset value:

```
selfPtr DWORD $
```

**Keyboard Definitions** Programs often define symbols that identify commonly used numeric keyboard codes. For example, 27 is the ASCII code for the Esc key:

```
Esc_key = 27
```

Later in the same program, a statement is more self-describing if it uses the symbol rather than an integer literal. Use

```
mov al,Esc_key ; good style
```

rather than

```
mov al,27 ; poor style
```

**Using the DUP Operator** Section 3.4.4 showed how to use the DUP operator to create storage for arrays and strings. The counter used by DUP should be a symbolic constant, to simplify program maintenance. In the next example, if COUNT has been defined, it can be used in the following data definition:

```
array dword COUNT DUP(0)
```

**Redefinitions** A symbol defined with = can be redefined within the same program. The following example shows how the assembler evaluates COUNT as it changes value:

```
COUNT = 5
mov al,COUNT ; AL = 5
COUNT = 10
mov al,COUNT ; AL = 10
COUNT = 100
mov al,COUNT ; AL = 100
```

The changing value of a symbol such as COUNT has nothing to do with the runtime execution order of statements. Instead, the symbol changes value according to the assembler's sequential processing of the source code during the assembler's preprocessing stage.

### 3.5.2 Calculating the Sizes of Arrays and Strings

When using an array, we usually like to know its size. The following example uses a constant named **ListSize** to declare the size of **list**:

```
list BYTE 10,20,30,40
ListSize = 4
```

Explicitly stating an array's size can lead to a programming error, particularly if you should later insert or remove array elements. A better way to declare an array size is to let the assembler calculate its value for you. The \$ operator (*current location counter*) returns the offset associated



with the current program statement. In the following example, **ListSize** is calculated by subtracting the offset of **list** from the current location counter (\$):

```
list BYTE 10,20,30,40
ListSize = ($ - list)
```

**ListSize** must follow immediately after **list**. The following, for example, produces too large a value (24) for **ListSize** because the storage used by **var2** affects the distance between the current location counter and the offset of **list**:

```
list BYTE 10,20,30,40
var2 BYTE 20 DUP(?)
ListSize = ($ - list)
```

Rather than calculating the length of a string manually, let the assembler do it:

```
myString BYTE "This is a long string, containing"
          BYTE "any number of characters"
myString_len = ($ - myString)
```

**Arrays of Words and DoubleWords** When calculating the number of elements in an array containing values other than bytes, you should always divide the total array size (in bytes) by the size of the individual array elements. The following code, for example, divides the address range by 2 because each word in the array occupies 2 bytes (16 bits):

```
list WORD 1000h,2000h,3000h,4000h
ListSize = ($ - list) / 2
```

Similarly, each element of an array of doublewords is 4 bytes long, so its overall length must be divided by four to produce the number of array elements:

```
list DWORD 10000000h,20000000h,30000000h,40000000h
ListSize = ($ - list) / 4
```

### 3.5.3 EQU Directive

The *EQU directive* associates a symbolic name with an integer expression or some arbitrary text. There are three formats:

```
name EQU expression
name EQU symbol
name EQU <text>
```

In the first format, *expression* must be a valid integer expression (see Section 3.1.3). In the second format, *symbol* is an existing symbol name, already defined with = or EQU. In the third format, any text may appear within the brackets <. .>. When the assembler encounters *name* later in the program, it substitutes the integer value or text for the symbol.

EQU can be useful when defining a value that does not evaluate to an integer. A real number constant, for example, can be defined using EQU:

```
PI EQU <3.1416>
```

**Example** The following example associates a symbol with a character string. Then a variable can be created using the symbol:

```

prompt EQU <"Press any key to continue...",0>
.
.
.data
prompt BYTE prompt

```

*Example* Suppose we would like to define a symbol that counts the number of cells in a 10-by-10 integer matrix. We will define symbols two different ways, first as an integer expression and second as a text expression. The two symbols are then used in data definitions:

```

matrix1 EQU 10 * 10
matrix2 EQU <10 * 10>
.data
M1 WORD matrix1
M2 WORD matrix2

```

The assembler produces different data definitions for **M1** and **M2**. The integer expression in **matrix1** is evaluated and assigned to **M1**. On the other hand, the text in **matrix2** is copied directly into the data definition for **M2**:

```

M1 WORD 100
M2 WORD 10 * 10

```

*No Redefinition* Unlike the = directive, a symbol defined with EQU cannot be redefined in the same source code file. This restriction prevents an existing symbol from being inadvertently assigned a new value.

### 3.5.4 TEXTEQU Directive

The *TEXTEQU directive*, similar to EQU, creates what is known as a *text macro*. There are three different formats: the first assigns text, the second assigns the contents of an existing text macro, and the third assigns a constant integer expression:

```

name TEXTEQU <text>
name TEXTEQU textmacro
name TEXTEQU %constExpr

```

For example, the **prompt1** variable uses the **continueMsg** text macro:

```

continueMsg TEXTEQU <"Do you wish to continue (Y/N)?">
.data
prompt1 BYTE continueMsg

```

Text macros can build on each other. In the next example, **count** is set to the value of an integer expression involving **rowSize**. Then the symbol **move** is defined as **mov**. Finally, **setupAL** is built from **move** and **count**:

```

rowSize = 5
count TEXTEQU %(rowSize * 2)
move TEXTEQU <mov>
setupAL TEXTEQU <move al,count>

```

Therefore, the statement

```
setupAL
```

would be assembled as

```
mov al,10
```

A symbol defined by `TEXTEQU` can be redefined at any time.

### 3.5.5 Section Review

1. Declare a symbolic constant using the equal-sign directive that contains the ASCII code (08h) for the Backspace key.
2. Declare a symbolic constant named **SecondsInDay** using the equal-sign directive and assign it an arithmetic expression that calculates the number of seconds in a 24-hour period.
3. Write a statement that causes the assembler to calculate the number of bytes in the following array, and assign the value to a symbolic constant named **ArraySize**:

```
myArray WORD 20 DUP(?)
```

4. Show how to calculate the number of elements in the following array, and assign the value to a symbolic constant named **ArraySize**:

```
myArray DWORD 30 DUP(?)
```

5. Use a `TEXTEQU` expression to redefine “proc” as “procedure.”
6. Use `TEXTEQU` to create a symbol named **Sample** for a string constant, and then use the symbol when defining a string variable named **MyString**.
7. Use `TEXTEQU` to assign the symbol **SetupESI** to the following line of code:

```
mov esi,OFFSET myArray
```

## 3.6 64-Bit Programming

With the advent of 64-bit processors by AMD and Intel, there has been increased interest in 64-bit programming. MASM supports 64-bit code, and the 64-bit version of the assembler is installed with all full versions of Visual Studio 2012 (Ultimate, Premium, or Professional) and with the Visual Studio 2012 Express for Desktop. In each chapter, beginning with this one, we will include 64-bit versions of some of the sample programs. We will also discuss the *Irvine64* subroutine library supplied with this book.

Let’s borrow the *AddTwoSum* program shown earlier in this chapter, and modify it for 64-bit programming. We will use the 64-bit register RAX to accumulate two integers, and store their sum in a 64-bit variable:

```
1: ; AddTwoSum_64.asm - Chapter 3 example.
2:
3: ExitProcess PROTO
4:
5: .data
6: sum DWORD 0
7:
8: .code
```

```

9: main PROC
10:  mov  eax, 5
11:  add  eax, 6
12:  mov  sum, eax
13:
14:  mov  ecx, 0
15:  call ExitProcess
16: main ENDP
17: END

```

Here's how this program is different from the 32-bit version we showed earlier in the chapter:

- The following three lines, which were in the 32-bit version of the AddTwoSum program are not used in the 64-bit version:

```

.386
.model flat, stdcall
.stack 4096

```

- Statements using the `PROTO` keyword do not have parameters in 64-bit programs. This is from Line 3:

```
ExitProcess PROTO
```

This was our earlier 32-bit version:

```
ExitProcess PROTO, dwExitCode:DWORD
```

- Lines 14–15 use two instructions to end the program (`mov` and `call`). The 32-bit version used an `INVOKE` statement to do the same thing. The 64-bit version of MASM does not support the `INVOKE` directive.
- In line 17, the end directive does not specify a program entry point. The 32-bit version of the program did.

### Using 64-Bit Registers

In some applications, you may need to perform arithmetic with integers that are larger than 32 bits. In that case, you can use 64-bit registers and variables. For example, this is how we could make our sample program use 64-bit values:

- In line 6, we would change `DWORD` to `QWORD` when declaring the `sum` variable.
- In lines 10–12, we would change `EAX` to its 64-bit version, named `RAX`.

This is how lines 6–12 would appear after we made the changes:

```

6: sum QWORD 0
7:
8: .code
9: main PROC
10:  mov  rax, 5
11:  add  rax, 6
12:  mov  sum, rax

```

Whether you write 32-bit or 64-bit assembly programs is largely a matter of preference. Here's something to remember: the 64-bit version of MASM 11.0 (shipped with Visual Studio 12) does

not support the INVOKE directive. Also, you must be running the 64-bit version of Windows in order to run 64-bit programs.

You can find instructions at the author's web site ([asmirvine.com](http://asmirvine.com)) to help you configure Visual Studio for 64-bit programming.

### 3.7 Chapter Summary

A constant integer expression is a mathematical expression involving integer literals, symbolic constants, and arithmetic operators. *Precedence* refers to the implied order of operations when an expression contains two or more operators.

A *character literal* is a single character enclosed in quotes. The assembler converts a character to a byte containing the character's binary ASCII code. A *string literal* is a sequence of characters enclosed in quotes, optionally ending with a null byte.

Assembly language has a set of *reserved words* with special meanings that may only be used in the correct context. An *identifier* is a programmer-chosen name identifying a variable, a symbolic constant, a procedure, or a code label. Identifiers cannot be reserved words.

A *directive* is a command embedded in the source code and interpreted by the assembler. An *instruction* is a source code statement that is executed by the processor at runtime. An *instruction mnemonic* is a short keyword that identifies the operation carried out by an instruction. A *label* is an identifier that acts as a place marker for instructions or data.

*Operands* are values passed to instructions. An assembly language instruction can have between zero and three operands, each of which can be a register, memory operand, integer expression, or input-output port number.

Programs contain *logical segments* named code, data, and stack. The code segment contains executable instructions. The stack segment holds procedure parameters, local variables, and return addresses. The data segment holds variables.

A *source file* contains assembly language statements. A *listing file* contains a copy of the program's source code, suitable for printing, with line numbers, offset addresses, translated machine code, and a symbol table. A source file is created with a text editor. An *assembler* is a program that reads the source file, producing both object and listing files. The *linker* is a program that reads one or more object files and produces an executable file. The latter is executed by the operating system loader.

MASM recognizes intrinsic data types, each of which describes a set of values that can be assigned to variables and expressions of the given type:

- BYTE and SBYTE define 8-bit variables.
- WORD and SWORD define 16-bit variables.
- DWORD and SDWORD define 32-bit variables.
- QWORD and TBYTE define 8-byte and 10-byte variables, respectively.
- REAL4, REAL8, and REAL10 define 4-byte, 8-byte, and 10-byte real number variables, respectively.

A *data definition statement* sets aside storage in memory for a variable, and may optionally assign it a name. If multiple initializers are used in the same data definition, its label refers only to the offset of the first initializer. To create a string data definition, enclose a sequence of characters in quotes. The DUP operator generates a repeated storage allocation, using a constant expression as a counter. The current location counter operator (\$) is used in address-calculation expressions.

x86 processors store and retrieve data from memory using *little-endian* order: The least significant byte of a variable is stored at its starting (lowest) address value.

A *symbolic constant* (or symbol definition) associates an identifier with an integer or text expression. Three directives create symbolic constants:

- The equal-sign directive (=) associates a symbol name with a constant integer expression.
- The EQU and TEXTEQU directives associate a symbolic name with a constant integer expression or some arbitrary text.

## 3.8 Key Terms

### 3.8.1 Terms

assembler	intrinsic data type
big endian	label
binary coded decimal (BCD)	linker
calling convention	link library
character literal	listing file
code label	little-endian order
code segment	macro
compiler	memory model
constant integer expression	memory operand
data definition statement	object file
data label	operand
data segment	operator precedence
decimal real	packed binary coded decimal
directive	process return code
encoded real	program entry point
executable file	real number literal
floating-point literal	reserved word
identifier	source file
initializer	stack segment
instruction	string literal
instruction mnemonic	symbolic constant
integer constant	system function
integer literal	

### 3.8.2 Instructions, Operators, and Directives

+	(add, unary plus)	END
=	(assign, compare for equality)	ENDP
/	(divide)	DUP
*	(multiply)	EQU
( )	(parentheses)	MOD
–	(subtract, unary minus)	MOV
ADD		NOP
BYTE		PROC
CALL		SBYTE
.CODE		SDWORD
COMMENT		.STACK
.DATA		TEXT EQU
DWORD		

## 3.9 Review Questions and Exercises

### 3.9.1 Short Answer

1. Provide examples of three different instruction mnemonics.
2. What is a calling convention, and how is it used in assembly language declarations?
3. How do you reserve space for the stack in a program?
4. Explain why the term *assembler language* is not quite correct.
5. Explain the difference between big endian and little endian. Also, look up the origins of this term on the Web.
6. Why might you use a symbolic constant rather than an integer literal in your code?
7. How is a source file different from a listing file?
8. How are data labels and code labels different?
9. (*True/False*): An identifier cannot begin with a numeric digit.
10. (*True/False*): A hexadecimal literal may be written as 0x3A.
11. (*True/False*): Assembly language directives execute at runtime.
12. (*True/False*): Assembly language directives can be written in any combination of uppercase and lowercase letters.
13. Name the four basic parts of an assembly language instruction.
14. (*True/False*): MOV is an example of an instruction mnemonic.
15. (*True/False*): A code label is followed by a colon (:), but a data label does not end with a colon.
16. Show an example of a block comment.
17. Why is it not a good idea to use numeric addresses when writing instructions that access variables?

18. What type of argument must be passed to the `ExitProcess` procedure?
19. Which directive ends a procedure?
20. In 32-bit mode, what is the purpose of the identifier in the `END` directive?
21. What is the purpose of the `PROTO` directive?
22. (*True/False*): An Object file is produced by the Linker.
23. (*True/False*): A Listing file is produced by the Assembler.
24. (*True/False*): A link library is added to a program just before producing an Executable file.
25. Which data directive creates a 32-bit signed integer variable?
26. Which data directive creates a 16-bit signed integer variable?
27. Which data directive creates a 64-bit unsigned integer variable?
28. Which data directive creates an 8-bit signed integer variable?
29. Which data directive creates a 10-byte packed BCD variable?

### 3.9.2 Algorithm Workbench

1. Define four symbolic constants that represent integer 25 in decimal, binary, octal, and hexadecimal formats.
2. Find out, by trial and error, if a program can have multiple code and data segments.
3. Create a data definition for a doubleword that stored it in memory in big endian format.
4. Find out if you can declare a variable of type `DWORD` and assign it a negative value. What does this tell you about the assembler's type checking?
5. Write a program that contains two instructions: (1) add the number 5 to the `EAX` register, and (2) add 5 to the `EDX` register. Generate a listing file and examine the machine code generated by the assembler. What differences, if any, did you find between the two instructions?
6. Given the number `456789ABh`, list out its byte values in little-endian order.
7. Declare an array of 120 uninitialized unsigned doubleword values.
8. Declare an array of byte and initialize it to the first 5 letters of the alphabet.
9. Declare a 32-bit signed integer variable and initialize it with the smallest possible negative decimal value. (Hint: Refer to integer ranges in Chapter 1.)
10. Declare an unsigned 16-bit integer variable named `wArray` that uses three initializers.
11. Declare a string variable containing the name of your favorite color. Initialize it as a nullterminated string.
12. Declare an uninitialized array of 50 signed doublewords named `dArray`.
13. Declare a string variable containing the word "TEST" repeated 500 times.
14. Declare an array of 20 unsigned bytes named `bArray` and initialize all elements to zero.



15. Show the order of individual bytes in memory (lowest to highest) for the following double-word variable:

```
val1 DWORD 87654321h
```

### 3.10 Programming Exercises

#### ★ 1. Integer Expression Calculation

Using the *AddTwo* program from Section 3.2 as a reference, write a program that calculates the following expression, using registers:  $A = (A + B) - (C + D)$ . Assign integer values to the EAX, EBX, ECX, and EDX registers.

#### ★ 2. Symbolic Integer Constants

Write a program that defines symbolic constants for all seven days of the week. Create an array variable that uses the symbols as initializers.

#### ★★ 3. Data Definitions

Write a program that contains a definition of each data type listed in Table 3-2 in Section 3.4. Initialize each variable to a value that is consistent with its data type.

#### ★ 4. Symbolic Text Constants

Write a program that defines symbolic names for several string literals (characters between quotes). Use each symbolic name in a variable definition.

#### ★★★★ 5. Listing File for AddTwoSum

Generate a listing file for the *AddTwoSum* program and write a description of the machine code bytes generated for each instruction. You might have to guess at some of the meanings of the byte values.

#### ★★★ 6. AddVariables Program

Modify the *AddVariables* program so it uses 64-bit variables. Describe the syntax errors generated by the assembler and what steps you took to resolve the errors.

---

# DATA TRANSFERS, ADDRESSING, AND ARITHMETIC

- 4.1 Data Transfer Instructions**
  - 4.1.1 Introduction
  - 4.1.2 Operand Types
  - 4.1.3 Direct Memory Operands
  - 4.1.4 MOV Instruction
  - 4.1.5 Zero/Sign Extension of Integers
  - 4.1.6 LAHF and SAHF Instructions
  - 4.1.7 XCHG Instruction
  - 4.1.8 Direct-Offset Operands
  - 4.1.9 Example Program (Moves)
  - 4.1.10 Section Review
- 4.2 Addition and Subtraction**
  - 4.2.1 INC and DEC Instructions
  - 4.2.2 ADD Instruction
  - 4.2.3 SUB Instruction
  - 4.2.4 NEG Instruction
  - 4.2.5 Implementing Arithmetic Expressions
  - 4.2.6 Flags Affected by Addition and Subtraction
  - 4.2.7 Example Program (*AddSubTest*)
  - 4.2.8 Section Review
- 4.3 Data-Related Operators and Directives**
  - 4.3.1 OFFSET Operator
  - 4.3.2 ALIGN Directive
  - 4.3.3 PTR Operator
  - 4.3.4 TYPE Operator
  - 4.3.5 LENGTHOF Operator
  - 4.3.6 SIZEOF Operator
  - 4.3.7 LABEL Directive
  - 4.3.8 Section Review
- 4.4 Indirect Addressing**
  - 4.4.1 Indirect Operands
  - 4.4.2 Arrays
  - 4.4.3 Indexed Operands
  - 4.4.4 Pointers
  - 4.4.5 Section Review
- 4.5 JMP and LOOP Instructions**
  - 4.5.1 JMP Instruction
  - 4.5.2 LOOP Instruction
  - 4.5.3 Displaying an Array in the Visual Studio Debugger
  - 4.5.4 Summing an Integer Array
  - 4.5.5 Copying a String
  - 4.5.6 Section Review
- 4.6 64-Bit Programming**
  - 4.6.1 MOV Instruction
  - 4.6.2 64-Bit Version of SumArray
  - 4.6.3 Addition and Subtraction
  - 4.6.4 Section Review
- 4.7 Chapter Summary**
- 4.8 Key Terms**
  - 4.8.1 Terms
  - 4.8.2 Instructions, Operators, and Directives
- 4.9 Review Questions and Exercises**
  - 4.9.1 Short Answer
  - 4.9.2 Algorithm Workbench
- 4.10 Programming Exercises**

This chapter introduces some essential instructions for transferring data and performing arithmetic. A large part of this chapter is devoted to the basic addressing modes, such as direct, immediate, and indirect, which make it possible to process arrays. Along with that, we show how to create loops, and use some of the basic operators, such as `OFFSET`, `PTR`, and `LENGTHOF`. After reading this chapter, you should have a basic working knowledge of assembly language, with the exception of conditional statements.

## 4.1 Data Transfer Instructions

### 4.1.1 Introduction

When programming in languages like Java or C++, it's easy for beginners to be annoyed when the compilers generate lots of syntax error messages. Compilers perform strict type checking in order to help you avoid possible errors such as mismatching variables and data. Assemblers, on the other hand, let you do just about anything you want, as long as the processor's instruction set can do what you ask. In other words, assembly language forces you to pay attention to data storage and machine-specific details. You must understand the processor's limitations when you write assembly language code. As it happens, x86 processors have what is commonly known as a *complex instruction set*, so they offer a lot of ways of doing things.

If you take the time to thoroughly learn the material presented in this chapter, the rest of this book will read a lot more smoothly. As the example programs become more complicated, you will rely on mastery of fundamental tools presented in this chapter.

### 4.1.2 Operand Types

Chapter 3 introduced x86 instruction formats:

```
[label:] mnemonic [operands] [ ; comment ]
```

Instructions can have zero, one, two, or three operands. Here, we omit the label and comment fields for clarity:

```
mnemonic
mnemonic [destination]
mnemonic [destination], [source]
mnemonic [destination], [source-1], [source-2]
```

There are three basic types of operands:

- Immediate—uses a numeric literal expression
- Register—uses a named register in the CPU
- Memory—references a memory location

Table 4-1 describes the standard operand types. It uses a simple notation for operands (in 32-bit mode) freely adapted from the Intel manuals. We will use it from this point on to describe the syntax of individual instructions.

### 4.1.3 Direct Memory Operands

Variable names are references to offsets within the data segment. For example, the following declaration for a variable named `var1` says that its size attribute is `byte` and it contains the value 10 hexadecimal:

Table 4-1 Instruction Operand Notation, 32-Bit Mode.

Operand	Description
<i>reg8</i>	8-bit general-purpose register: AH, AL, BH, BL, CH, CL, DH, DL
<i>reg16</i>	16-bit general-purpose register: AX, BX, CX, DX, SI, DI, SP, BP
<i>reg32</i>	32-bit general-purpose register: EAX, EBX, ECX, EDX, ESI, EDI, ESP, EBP
<i>reg</i>	Any general-purpose register
<i>seg</i>	16-bit segment register: CS, DS, SS, ES, FS, GS
<i>imm</i>	8-, 16-, or 32-bit immediate value
<i>imm8</i>	8-bit immediate byte value
<i>imm16</i>	16-bit immediate word value
<i>imm32</i>	32-bit immediate doubleword value
<i>reg/mem8</i>	8-bit operand, which can be an 8-bit general register or memory byte
<i>reg/mem16</i>	16-bit operand, which can be a 16-bit general register or memory word
<i>reg/mem32</i>	32-bit operand, which can be a 32-bit general register or memory doubleword
<i>mem</i>	An 8-, 16-, or 32-bit memory operand

```
.data
var1 BYTE 10h
```

We can write instructions that dereference (look up) memory operands using their addresses. Suppose **var1** were located at offset 10400h. The following instruction copies its value into the AL register:

```
mov al var1
```

It would be assembled into the following machine instruction:

```
A0 00010400
```

The first byte in the machine instruction is the operation code (known as the *opcode*). The remaining part is the 32-bit hexadecimal address of **var1**. Although it might be possible to write programs using only numeric addresses, symbolic names such as **var1** make it easier to reference memory.

**Alternative Notation.** Some programmers prefer to use the following notation with direct operands because the brackets imply a dereference operation:

```
mov al, [var1]
```

MASM permits this notation, so you can use it in your own programs if you want. Because so many programs (including those from Microsoft) are printed without the brackets, we will only use them in this book when an arithmetic expression is involved:

```
mov al, [var1 + 5]
```

(This is called a direct-offset operand, a subject discussed at length in Section 4.1.8.)

#### 4.1.4 MOV Instruction

The MOV instruction copies data from a source operand to a destination operand. Known as a *data transfer* instruction, it is used in virtually every program. Its basic format shows that the first operand is the destination and the second operand is the source:

```
MOV destination, source
```

The destination operand's contents change, but the source operand is unchanged. The right to left movement of data is similar to the assignment statement in C++ or Java:

```
dest = source;
```

In nearly all assembly language instructions, the left-hand operand is the destination and the right-hand operand is the source. MOV is very flexible in its use of operands, as long as the following rules are observed:

- Both operands must be the same size.
- Both operands cannot be memory operands.
- The instruction pointer register (IP, EIP, or RIP) cannot be a destination operand.

Here is a list of the standard MOV instruction formats:

```
MOV reg, reg
MOV mem, reg
MOV reg, mem
MOV mem, imm
MOV reg, imm
```

**Memory to Memory** A single MOV instruction cannot be used to move data directly from one memory location to another. Instead, you must move the source operand's value to a register before assigning its value to a memory operand:

```
.data
var1 WORD ?
var2 WORD ?
.code
mov ax, var1
mov var2, ax
```

You must consider the minimum number of bytes required by an integer constant when copying it to a variable or register. For unsigned integer constant sizes, refer to Table 1-4 in Chapter 1. For signed integer constants, refer to Table 1-7.

#### Overlapping Values

The following code example shows how the same 32-bit register can be modified using differently sized data. When **oneWord** is moved to AX, it overwrites the existing value of AL. When **oneDword** is moved to EAX, it overwrites AX. Finally, when 0 is moved to AX, it overwrites the lower half of EAX.

```
.data
oneByte BYTE 78h
oneWord WORD 1234h
oneDword DWORD 12345678h
```

```

.code
mov  eax,0           ; EAX = 00000000h
mov  al,oneByte     ; EAX = 00000078h
mov  ax,oneWord     ; EAX = 00001234h
mov  eax,oneDword   ; EAX = 12345678h
mov  ax,0           ; EAX = 12340000h

```

### 4.1.5 Zero/Sign Extension of Integers

#### **Copying Smaller Values to Larger Ones**

Although MOV cannot directly copy data from a smaller operand to a larger one, programmers can create workarounds. Suppose **count** (unsigned, 16 bits) must be moved to ECX (32 bits). We can set ECX to zero and move **count** to CX:

```

.data
count WORD 1
.code
mov  ecx,0
mov  cx,count

```

What happens if we try the same approach with a signed integer equal to  $-16$ ?

```

.data
signedVal SWORD -16           ; FFF0h (-16)
.code
mov  ecx,0
mov  cx,signedVal             ; ECX = 0000FFF0h (+65,520)

```

The value in ECX ( $+65,520$ ) is completely different from  $-16$ . On the other hand, if we had filled ECX first with FFFFFFFFh and then copied **signedVal** to CX, the final value would have been correct:

```

mov  ecx,0FFFFFFFh
mov  cx,signedVal           ; ECX = FFFFFFFF0h (-16)

```

The effective result of this example was to use the highest bit of the source operand (1) to fill the upper 16 bits of the destination operand, ECX. This technique is called *sign extension*. Of course, we cannot always assume that the highest bit of the source is a 1. Fortunately, the engineers at Intel anticipated this problem when designing the instruction set and introduced the MOVZX and MOVZX instructions to deal with both unsigned and signed integers.

#### **MOVZX Instruction**

The MOVZX instruction (*move with zero-extend*) copies the contents of a source operand into a destination operand and zero-extends the value to 16 or 32 bits. This instruction is only used with unsigned integers. There are three variants:

```

MOVZX  reg32, reg/mem8
MOVZX  reg32, reg/mem16
MOVZX  reg16, reg/mem8

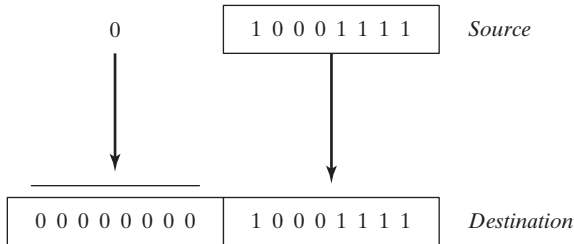
```

(Operand notation was explained in Table 4-1.) In each of the three variants, the first operand (a register) is the destination and the second is the source. Notice that the source operand cannot be a constant. The following example zero-extends binary 10001111 into AX:

```
.data
byteVal BYTE 10001111b
.code
movzx ax,byteVal           ; AX = 0000000010001111b
```

Figure 4-1 shows how the source operand is zero-extended into the 16-bit destination.

FIGURE 4-1 Using MOVZX to copy a byte into a 16-bit destination.



The following examples use registers for all operands, showing all the size variations:

```
mov    bx,0A69Bh
movzx  eax,bx           ; EAX = 0000A69Bh
movzx  edx,bl           ; EDX = 0000009Bh
movzx  cx,bl            ; CX  = 009Bh
```

The following examples use memory operands for the source and produce the same results:

```
.data
byte1  BYTE 9Bh
word1  WORD 0A69Bh
.code
movzx  eax,word1       ; EAX = 0000A69Bh
movzx  edx,byte1       ; EDX = 0000009Bh
movzx  cx,byte1        ; CX  = 009Bh
```

### **MOVZX Instruction**

The MOVZX instruction (move with sign-extend) copies the contents of a source operand into a destination operand and sign-extends the value to 16 or 32 bits. This instruction is only used with signed integers. There are three variants:

```
MOVZX  reg32,reg/mem8
MOVZX  reg32,reg/mem16
MOVZX  reg16,reg/mem8
```

An operand is sign-extended by taking the smaller operand's highest bit and repeating (replicating) the bit throughout the extended bits in the destination operand. The following example sign-extends binary 10001111b into AX:

```

.data
byteVal BYTE 10001111b
.code
movsx ax,byteVal           ; AX = 1111111110001111b

```

The lowest 8 bits are copied as in Figure 4-2. The highest bit of the source is copied into each of the upper 8 bit positions of the destination.

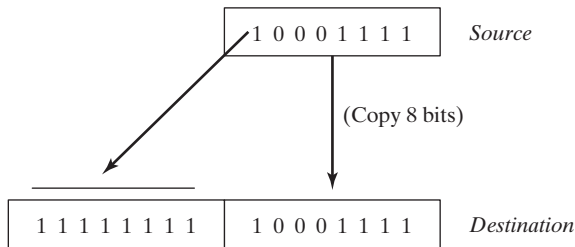
A hexadecimal constant has its highest bit set if its most significant hexadecimal digit is greater than 7. In the following example, the hexadecimal value moved to BX is A69B, so the leading “A” digit tells us that the highest bit is set. (The leading zero appearing before A69B is just a notational convenience so the assembler does not mistake the constant for the name of an identifier.)

```

mov    bx,0A69Bh
movsx  eax,bx           ; EAX = FFFFA69Bh
movsx  edx,bl           ; EDX = FFFFFFF9Bh
movsx  cx,bl            ; CX = FF9Bh

```

FIGURE 4-2 Using MOVSBX to copy a byte into a 16-bit destination.



#### 4.1.6 LAHF and SAHF Instructions

The LAHF (load status flags into AH) instruction copies the low byte of the EFLAGS register into AH. The following flags are copied: Sign, Zero, Auxiliary Carry, Parity, and Carry. Using this instruction, you can easily save a copy of the flags in a variable for safekeeping:

```

.data
saveflags BYTE ?
.code
lahf           ; load flags into AH
mov saveflags,ah ; save them in a variable

```

The SAHF (store AH into status flags) instruction copies AH into the low byte of the EFLAGS (or RFLAGS) register. For example, you can retrieve the values of flags saved earlier in a variable:

```

mov ah,saveflags ; load saved flags into AH
sahf             ; copy into Flags register

```



### 4.1.7 XCHG Instruction

The XCHG (exchange data) instruction exchanges the contents of two operands. There are three variants:

```
XCHG reg, reg
XCHG reg, mem
XCHG mem, reg
```

The rules for operands in the XCHG instruction are the same as those for the MOV instruction (Section 4.1.4), except that XCHG does not accept immediate operands. In array sorting applications, XCHG provides a simple way to exchange two array elements. Here are a few examples using XCHG:

```
xchg ax, bx           ; exchange 16-bit regs
xchg ah, al           ; exchange 8-bit regs
xchg var1, bx         ; exchange 16-bit mem op with BX
xchg eax, ebx         ; exchange 32-bit regs
```

To exchange two memory operands, use a register as a temporary container and combine MOV with XCHG:

```
mov ax, val1
xchg ax, val2
mov val1, ax
```

### 4.1.8 Direct-Offset Operands

You can add a displacement to the name of a variable, creating a direct-offset operand. This lets you access memory locations that may not have explicit labels. Let's begin with an array of bytes named **arrayB**:

```
arrayB BYTE 10h, 20h, 30h, 40h, 50h
```

If we use MOV with **arrayB** as the source operand, we automatically move the first byte in the array:

```
mov al, arrayB           ; AL = 10h
```

We can access the second byte in the array by adding 1 to the offset of **arrayB**:

```
mov al, [arrayB+1]       ; AL = 20h
```

The third byte is accessed by adding 2:

```
mov al, [arrayB+2]       ; AL = 30h
```

An expression such as **arrayB+1** produces what is called an *effective address* by adding a constant to the variable's offset. Surrounding an effective address with brackets makes it clear that the expression is dereferenced to obtain the contents of memory at the address. The assembler does not require you to surround address expressions with brackets, but we highly recommend their use for clarity.

MASM has no built-in range checking for effective addresses. In the following example, assuming **arrayB** holds five bytes, the instruction retrieves a byte of memory outside the array. The result is a sneaky logic bug, so be extra careful when checking array references:

```
mov al, [arrayB+20]       ; AL = ??
```

**Word and Doubleword Arrays** In an array of 16-bit words, the offset of each array element is 2 bytes beyond the previous one. That is why we add 2 to **ArrayW** in the next example to reach the second element:

```
.data
arrayW WORD 100h,200h,300h
.code
mov ax,arrayW           ; AX = 100h
mov ax,[arrayW+2]      ; AX = 200h
```

Similarly, the second element in a doubleword array is 4 bytes beyond the first one:

```
.data
arrayD DWORD 10000h,20000h
.code
mov eax,arrayD         ; EAX = 10000h
mov eax,[arrayD+4]    ; EAX = 20000h
```

### 4.1.9 Example Program (Moves)

Let's combine all the instructions we've covered so far in this chapter, including MOV, XCHG, MOVSX, and MOVDX, to show how bytes, words, and doublewords are affected. We will also include some direct-offset operands.

```
; Data Transfer Examples (Moves.asm)

.386
.model flat,stdcall
.stack 4096
ExitProcess PROTO,dwExitCode:DWORD
.data
val1 WORD 1000h
val2 WORD 2000h
arrayB BYTE 10h,20h,30h,40h,50h
arrayW WORD 100h,200h,300h
arrayD DWORD 10000h,20000h

.code
main PROC

; Demonstrating MOVZX instruction:
mov bx,0A69Bh
movzx eax,bx           ; EAX = 0000A69Bh
movzx edx,bl          ; EDX = 0000009Bh
movzx cx,bl           ; CX = 009Bh

; Demonstrating MOVSX instruction:
mov bx,0A69Bh
movsx eax,bx          ; EAX = FFFFA69Bh
movsx edx,bl          ; EDX = FFFFFFF9Bh
mov bl,7Bh
movsx cx,bl           ; CX = 007Bh

; Memory-to-memory exchange:
mov ax,val1           ; AX = 1000h
```

```

    xchg ax, val2                ; AX=2000h, val2=1000h
    mov  val1, ax                ; val1 = 2000h

; Direct-Offset Addressing (byte array):
    mov  al, arrayB              ; AL = 10h
    mov  al, [arrayB+1]         ; AL = 20h
    mov  al, [arrayB+2]         ; AL = 30h

; Direct-Offset Addressing (word array):
    mov  ax, arrayW              ; AX = 100h
    mov  ax, [arrayW+2]         ; AX = 200h

; Direct-Offset Addressing (doubleword array):
    mov  eax, arrayD             ; EAX = 10000h
    mov  eax, [arrayD+4]        ; EAX = 20000h
    mov  eax, [arrayD+4]        ; EAX = 20000h

    INVOKE ExitProcess, 0
main ENDP
END main

```

This program generates no screen output, but you can (and should) run it using a debugger.

### Displaying CPU Flags in the Visual Studio Debugger

To display the CPU status flags during a debugging session, select *Windows* from the *Debug* menu, then select *Registers* from the *Windows* menu. Inside the *Registers* window, right-click and select *Flags* from the dropdown list. You must be currently debugging a program in order to see these menu options. The following table identifies the flag symbols used inside the *Registers* window:

Flag Name	Overflow	Direction	Interrupt	Sign	Zero	Aux Carry	Parity	Carry
Symbol	OV	UP	EI	PL	ZR	AC	PE	CY

Each flag is assigned a value of 0 (*clear*) or 1 (*set*). Here's an example:

```

OV = 0 UP = 0 EI = 1
PL = 0 ZR = 1 AC = 0
PE = 1 CY = 0

```

As you step through your code during a debugging session, each flag displays in red when an instruction modifies the flag's value. You can learn how instructions affect the flags by stepping through instructions and keeping an eye on the changing values of the flags.

#### 4.1.10 Section Review

1. What are the three basic types of operands?
2. (*True/False*): The destination operand of a MOV instruction cannot be a segment register.
3. (*True/False*): In a MOV instruction, the second operand is known as the *destination* operand.

4. (*True/False*): The EIP register cannot be the destination operand of a MOV instruction.
5. In the operand notation used by Intel, what does *reg/mem32* indicate?
6. In the operand notation used by Intel, what does *imm16* indicate?

## 4.2 Addition and Subtraction

Arithmetic is a surprisingly big topic in assembly language! This chapter will focus on addition and subtraction. Then we will talk about multiplication and division later in Chapter 7. Then we'll switch over to floating point arithmetic in Chapter 12.

Let's start with the easiest and most efficient instructions of them all: INC (increment) and DEC (decrement), which add 1 and subtract 1. Then we will move on to the ADD, SUB, and NEG (negate) instructions, which offer more possibilities. Last of all, we will get into a discussion about how the CPU status flags (Carry, Sign, Zero, etc.) are affected by arithmetic instructions. Remember, assembly language is all about the details.

### 4.2.1 INC and DEC Instructions

The INC (increment) and DEC (decrement) instructions, respectively, add 1 and subtract 1 from a register or memory operand. The syntax is

```
INC reg/mem
DEC reg/mem
```

Following are some examples:

```
.data
myWord WORD 1000h
.code
inc myWord           ; myWord = 1001h
mov bx,myWord
dec bx               ; BX = 1000h
```

The Overflow, Sign, Zero, Auxiliary Carry, and Parity flags are changed according to the value of the destination operand. The INC and DEC instructions do not affect the Carry flag (which is something of a surprise).

### 4.2.2 ADD Instruction

The ADD instruction adds a source operand to a destination operand of the same size. The syntax is

```
ADD dest,source
```

*Source* is unchanged by the operation, and the sum is stored in the destination operand. The set of possible operands is the same as for the MOV instruction (Section 4.1.4). Here is a short code example that adds two 32-bit integers:

```
.data
var1 DWORD 10000h
var2 DWORD 20000h
.code
mov eax,var1         ; EAX = 10000h
add eax,var2         ; EAX = 30000h
```

**Flags** The Carry, Zero, Sign, Overflow, Auxiliary Carry, and Parity flags are changed according to the value that is placed in the destination operand. We will explain how the flags work in Section 4.2.6.

### 4.2.3 SUB Instruction

The SUB instruction subtracts a source operand from a destination operand. The set of possible operands is the same as for the ADD and MOV instructions. The syntax is

```
SUB dest, source
```

Here is a short code example that subtracts two 32-bit integers:

```
.data
var1 DWORD 30000h
var2 DWORD 10000h
.code
mov  eax, var1           ; EAX = 30000h
sub  eax, var2           ; EAX = 20000h
```

**Flags** The Carry, Zero, Sign, Overflow, Auxiliary Carry, and Parity flags are changed according to the value that is placed in the destination operand.

### 4.2.4 NEG Instruction

The NEG (negate) instruction reverses the sign of a number by converting the number to its two's complement. The following operands are permitted:

```
NEG reg
NEG mem
```

(Recall that the two's complement of a number can be found by reversing all the bits in the destination operand and adding 1.)

**Flags** The Carry, Zero, Sign, Overflow, Auxiliary Carry, and Parity flags are changed according to the value that is placed in the destination operand.

### 4.2.5 Implementing Arithmetic Expressions

Armed with the ADD, SUB, and NEG instructions, you have the means to implement arithmetic expressions involving addition, subtraction, and negation in assembly language. In other words, you can simulate what a C++ compiler might do when a statement such as this:

```
Rval = -Xval + (Yval - Zval);
```

Let's see how the sample statement would be implemented in assembly language. The following signed 32-bit variables will be used:

```
Rval SDWORD ?
Xval SDWORD 26
Yval SDWORD 30
Zval SDWORD 40
```

When translating an expression, evaluate each term separately and combine the terms at the end. First, we negate a copy of **Xval** and store it in a register:

```
; first term: -Xval
mov  eax,Xval
neg  eax                ; EAX = -26
```

Then **Yval** is copied to a register and **Zval** is subtracted:

```
; second term: (Yval - Zval)
mov  ebx,Yval
sub  ebx,Zval          ; EBX = -10
```

Finally, the two terms (in EAX and EBX) are added:

```
; add the terms and store:
add  eax,ebx
mov  Rval,eax          ; -36
```

### 4.2.6 Flags Affected by Addition and Subtraction

When executing arithmetic instructions, we often want to know something about the result. Is it negative, positive, or zero? Is it too large or too small to fit into the destination operand? Answers to such questions can help us detect calculation errors that might otherwise cause erratic program behavior. We use the values of CPU status flags to check the outcome of arithmetic operations. We also use status flag values to activate conditional branching instructions, the basic tools of program logic. Here's a quick overview of the status flags.

- The Carry flag indicates unsigned integer overflow. For example, if an instruction has an 8-bit destination operand but the instruction generates a result larger than 11111111 binary, the Carry flag is set.
- The Overflow flag indicates signed integer overflow. For example, if an instruction has a 16-bit destination operand but it generates a negative result smaller than  $-32,768$  decimal, the Overflow flag is set.
- The Zero flag indicates that an operation produced zero. For example, if an operand is subtracted from another of equal value, the Zero flag is set.
- The Sign flag indicates that an operation produced a negative result. If the most significant bit (MSB) of the destination operand is set, the Sign flag is set.
- The Parity flag indicates whether or not an even number of 1 bits occurs in the least significant byte of the destination operand, immediately after an arithmetic or boolean instruction has executed.
- The Auxiliary Carry flag is set when a 1 bit carries out of position 3 in the least significant byte of the destination operand.

To display CPU status flag values when debugging, open the Registers window, right-click in the window, and select *Flags*.

### Unsigned Operations: Zero, Carry, and Auxiliary Carry

The Zero flag is set when the result of an arithmetic operation equals zero. The following examples show the state of the destination register and Zero flag after executing the SUB, INC, and DEC instructions:

```

mov  ecx,1
sub  ecx,1                ; ECX = 0, ZF = 1
mov  eax,0FFFFFFFFh
inc  eax                  ; EAX = 0, ZF = 1
inc  eax                  ; EAX = 1, ZF = 0
dec  eax                  ; EAX = 0, ZF = 1

```

**Addition and the Carry Flag** The Carry flag's operation is easiest to explain if we consider addition and subtraction separately. When adding two unsigned integers, the Carry flag is a copy of the carry out of the most significant bit of the destination operand. Intuitively, we can say  $CF = 1$  when the sum exceeds the storage size of its destination operand. In the next example, ADD sets the Carry flag because the sum (100h) is too large for AL:

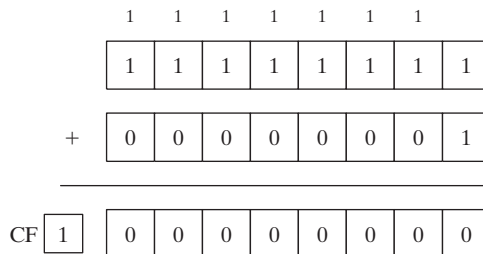
```

mov  al,0FFh
add  al,1                 ; AL = 00, CF = 1

```

Figure 4-3 shows what happens at the bit level when 1 is added to 0FFh. The carry out of the highest bit position of AL is copied into the Carry flag.

FIGURE 4-3 Adding 1 to 0FFh sets the Carry flag.



On the other hand, if 1 is added to 00FFh in AX, the sum easily fits into 16 bits and the Carry flag is clear:

```

mov  ax,00FFh
add  ax,1                ; AX = 0100h, CF = 0

```

But adding 1 to FFFFh in the AX register generates a Carry out of the high bit position of AX:

```

mov  ax,0FFFFh
add  ax,1                ; AX = 0000, CF = 1

```

**Subtraction and the Carry Flag** A subtract operation sets the Carry flag when a larger unsigned integer is subtracted from a smaller one. Figure 4-4 shows what happens when we subtract 2 from 1, using 8-bit operands. Here is the corresponding assembly code:

```

mov  al,1
sub  al,2                ; AL = FFh, CF = 1

```

**Tip:** The INC and DEC instructions do not affect the Carry flag. Applying the NEG instruction to a nonzero operand always sets the Carry flag.

FIGURE 4-4 Subtracting 2 from 1 sets the Carry flag.

$$\begin{array}{r}
 \begin{array}{|c|c|c|c|c|c|c|c|} \hline 0 & 0 & 0 & 0 & 0 & 0 & 0 & 1 \\ \hline \end{array} & (1) \\
 + & \begin{array}{|c|c|c|c|c|c|c|c|} \hline 1 & 1 & 1 & 1 & 1 & 1 & 1 & 0 \\ \hline \end{array} & (-2) \\
 \hline
 \text{CF } \begin{array}{|c|} \hline 1 \\ \hline \end{array} & \begin{array}{|c|c|c|c|c|c|c|c|} \hline 1 & 1 & 1 & 1 & 1 & 1 & 1 & 1 \\ \hline \end{array} & (\text{FFh})
 \end{array}$$

**Auxiliary Carry** The Auxiliary Carry (AC) flag indicates a carry or borrow out of bit 3 in the destination operand. It is primarily used in binary coded decimal (BCD) arithmetic, but can be used in other contexts. Suppose we add 1 to 0Fh. The sum (10h) contains a 1 in bit position 4 that was carried out of bit position 3:

```

mov  al,0Fh
add  al,1           ; AC = 1

```

Here is the arithmetic:

$$\begin{array}{r}
 0\ 0\ 0\ 0\ 1\ 1\ 1\ 1 \\
 +\ 0\ 0\ 0\ 0\ 0\ 0\ 0\ 1 \\
 \hline
 0\ 0\ 0\ 1\ 0\ 0\ 0\ 0
 \end{array}$$

**Parity** The Parity flag (PF) is set when the least significant byte of the destination has an even number of 1 bits. The following ADD and SUB instructions alter the parity of AL:

```

mov  al,10001100b
add  al,00000010b   ; AL = 10001110, PF = 1
sub  al,10000000b   ; AL = 00001110, PF = 0

```

After the ADD instruction executes, AL contains binary 10001110 (four 0 bits and four 1 bits), and PF = 1. After the SUB instruction executes, AL contains an odd number of 1 bits, so the Parity flag equals 0.

### Signed Operations: Sign and Overflow Flags

**Sign Flag** The Sign flag is set when the result of a signed arithmetic operation is negative. The next example subtracts a larger integer (5) from a smaller one (4):

```

mov  eax,4
sub  eax,5           ; EAX = -1, SF = 1

```

From a mechanical point of view, the Sign flag is a copy of the destination operand's high bit. The next example shows the hexadecimal values of BL when a negative result is generated:

```

mov  bl,1           ; BL = 01h
sub  bl,2           ; BL = FFh (-1), SF = 1

```



**Overflow Flag** The Overflow flag is set when the result of a signed arithmetic operation overflows or underflows the destination operand. For example, from Chapter 1 we know that the largest possible integer signed byte value is +127; adding 1 to it causes overflow:

```
mov al,+127
add al,1                ; OF = 1
```

Similarly, the smallest possible negative integer byte value is -128. Subtracting 1 from it causes underflow. The destination operand value does not hold a valid arithmetic result, and the Overflow flag is set:

```
mov al,-128
sub al,1                ; OF = 1
```

**The Addition Test** There is a very easy way to tell whether signed overflow has occurred when adding two operands. Overflow occurs when:

- Adding two positive operands generates a negative sum
- Adding two negative operands generates a positive sum

Overflow never occurs when the signs of two addition operands are different.

**How the Hardware Detects Overflow** The CPU uses an interesting mechanism to determine the state of the Overflow flag after an addition or subtraction operation. The value that carries out of the highest bit position is exclusive ORed with the carry into the high bit of the result. The resulting value is placed in the Overflow flag. In Figure 4-5, we show that adding the 8-bit binary integers 10000000 and 11111110 produces CF = 1, with carryIn(bit7) = 0. In other words, 1 XOR 0 produces OF = 1.

FIGURE 4-5 Demonstration of how the Overflow flag is set.

		1 0 0 0 0 0 0 0
	+	1 1 1 1 1 1 1 0
CF	1	0 1 1 1 1 1 1 0

**NEG Instruction** The NEG instruction produces an invalid result if the destination operand cannot be stored correctly. For example, if we move -128 to AL and try to negate it, the correct value (+128) will not fit into AL. The Overflow flag is set, indicating that AL contains an invalid value:

```
mov al,-128             ; AL = 10000000b
neg al                 ; AL = 10000000b, OF = 1
```

On the other hand, if +127 is negated, the result is valid and the Overflow flag is clear:

```
mov al,+127            ; AL = 01111111b
neg al                 ; AL = 10000001b, OF = 0
```

How does the CPU know whether an arithmetic operation is signed or unsigned? We can only give what seems a dumb answer: It doesn't! The CPU sets all status flags after an arithmetic operation using a set of boolean rules, regardless of which flags are relevant. You (the programmer) decide which flags to interpret and which to ignore, based on your knowledge of the type of operation performed.

### 4.2.7 Example Program (*AddSubTest*)

The *AddSubTest* program shown below implements various arithmetic expressions using the ADD, SUB, INC, DEC, and NEG instructions, and shows how certain status flags are affected:

```

; Addition and Subtraction      (AddSubTest.asm)

.386
.model flat,stdcall
.stack 4096
ExitProcess proto,dwExitCode:dword
.data
Rval    SDWORD ?
Xval    SDWORD 26
Yval    SDWORD 30
Zval    SDWORD 40

.code
main PROC
    ; INC and DEC
    mov  ax,1000h
    inc  ax                ; 1001h
    dec  ax                ; 1000h

    ; Expression: Rval = -Xval + (Yval - Zval)
    mov  eax,Xval
    neg  eax                ; -26
    mov  ebx,Yval
    sub  ebx,Zval          ; -10
    add  eax,ebx
    mov  Rval,eax          ; -36

    ; Zero flag example:
    mov  cx,1
    sub  cx,1              ; ZF = 1
    mov  ax,0FFFFh
    inc  ax                ; ZF = 1

    ; Sign flag example:
    mov  cx,0
    sub  cx,1              ; SF = 1
    mov  ax,7FFFh
    add  ax,2              ; SF = 1

    ; Carry flag example:
    mov  al,0FFh
    add  al,1              ; CF = 1,  AL = 00

    ; Overflow flag example:
    mov  al,+127
    add  al,1              ; OF = 1
    mov  al,-128
    sub  al,1              ; OF = 1

    INVOKE ExitProcess,0
main ENDP
END main

```

### 4.2.8 Section Review

Use the following data for Questions 1-5:

```
.data
val1 BYTE 10h
val2 WORD 8000h
val3 DWORD 0FFFFh
val4 WORD 7FFFh
```

1. Write an instruction that increments **val2**.
2. Write an instruction that subtracts **val3** from EAX.
3. Write instructions that subtract **val4** from **val2**.
4. If **val2** is incremented by 1 using the ADD instruction, what will be the values of the Carry and Sign flags?
5. If **val4** is incremented by 1 using the ADD instruction, what will be the values of the Overflow and Sign flags?
6. Where indicated, write down the values of the Carry, Sign, Zero, and Overflow flags after each instruction has executed:

```
mov ax, 7FF0h
add al, 10h           ; a. CF =   SF =   ZF =   OF =
add ah, 1            ; b. CF =   SF =   ZF =   OF =
add ax, 2            ; c. CF =   SF =   ZF =   OF =
```

## 4.3 Data-Related Operators and Directives

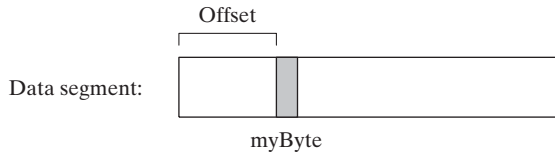
Operators and directives are not executable instructions; instead, they are interpreted by the assembler. You can use a number of assembly language directives to get information about the addresses and size characteristics of data:

- The **OFFSET** operator returns the distance of a variable from the beginning of its enclosing segment.
- The **PTR** operator lets you override an operand's default size.
- The **TYPE** operator returns the size (in bytes) of an operand or of each element in an array.
- The **LENGTHOF** operator returns the number of elements in an array.
- The **SIZEOF** operator returns the number of bytes used by an array initializer.

In addition, the **LABEL** directive provides a way to redefine the same variable with different size attributes. The operators and directives in this chapter represent only a small subset of the operators supported by MASM. You may want to view the complete list in Appendix D.

### 4.3.1 OFFSET Operator

The **OFFSET** operator returns the offset of a data label. The offset represents the distance, in bytes, of the label from the beginning of the data segment. To illustrate, Figure 4-6 shows a variable named **myByte** inside the data segment.

FIGURE 4–6 A variable named `myByte`.

### OFFSET Examples

In the next example, we declare three different types of variables:

```
.data
bVal BYTE ?
wVal WORD ?
dVal DWORD ?
dVal2 DWORD ?
```

If `bVal` were located at offset `00404000` (hexadecimal), the `OFFSET` operator would return the following values:

```
mov esi,OFFSET bVal           ; ESI = 00404000h
mov esi,OFFSET wVal          ; ESI = 00404001h
mov esi,OFFSET dVal          ; ESI = 00404003h
mov esi,OFFSET dVal2         ; ESI = 00404007h
```

`OFFSET` can also be applied to a direct-offset operand. Suppose `myArray` contains five 16-bit words. The following `MOV` instruction obtains the offset of `myArray`, adds 4, and moves the resulting address to `ESI`. We can say that `ESI` points to the third integer in the array:

```
.data
myArray WORD 1,2,3,4,5
.code
mov esi,OFFSET myArray + 4
```

You can initialize a doubleword variable with the offset of another variable, effectively creating a pointer. In the following example, `pArray` points to the beginning of `bigArray`:

```
.data
bigArray DWORD 500 DUP(?)
pArray DWORD bigArray
```

The following statement loads the pointer's value into `ESI`, so the register can point to the beginning of the array:

```
mov esi,pArray
```

#### 4.3.2 ALIGN Directive

The `ALIGN` directive aligns a variable on a byte, word, doubleword, or paragraph boundary. The syntax is

```
ALIGN bound
```

*Bound* can be 1, 2, 4, 8, or 16. A value of 1 aligns the next variable on a 1-byte boundary (the default). If *bound* is 2, the next variable is aligned on an even-numbered address. If *bound* is 4, the next address is a multiple of 4. If *bound* is 16, the next address is a multiple of 16, a paragraph boundary. The assembler can insert one or more empty bytes before the variable to fix the alignment. Why bother aligning data? Because the CPU can process data stored at even-numbered addresses more quickly than those at odd-numbered addresses.

In the following example, **bVal** is arbitrarily located at offset 00404000. Inserting the **ALIGN 2** directive before **wVal** causes it to be assigned an even-numbered offset:

```
bVal BYTE ? ; 00404000h
ALIGN 2
wVal WORD ? ; 00404002h
bVal2 BYTE ? ; 00404004h
ALIGN 4
dVal DWORD ? ; 00404008h
dVal2 DWORD ? ; 0040400Ch
```

Note that **dVal** would have been at offset 00404005, but the **ALIGN 4** directive bumped it up to offset 00404008.

### 4.3.3 PTR Operator

You can use the **PTR** operator to override the declared size of an operand. This is only necessary when you're trying to access the operand using a size attribute that is different from the one assumed by the assembler.

Suppose, for example, that you would like to move the lower 16 bits of a doubleword variable named **myDouble** into **AX**. The assembler will not permit the following move because the operand sizes do not match:

```
.data
myDouble DWORD 12345678h
.code
mov ax,myDouble ; error
```

But the **WORD PTR** operator makes it possible to move the low-order word (5678h) to **AX**:

```
mov ax,WORD PTR myDouble
```

Why wasn't 1234h moved into **AX**? x86 processors use the *little endian* storage format (Section 3.4.9), in which the low-order byte is stored at the variable's starting address. In Figure 4-7, the memory layout of **myDouble** is shown three ways: first as a doubleword, then as two words (5678h, 1234h), and finally as four bytes (78h, 56h, 34h, 12h).

We can access memory in any of these three ways, independent of the way a variable was defined. For example, if **myDouble** begins at offset 0000, the 16-bit value stored at that address is 5678h. We could also retrieve 1234h, the word at location **myDouble+2**, using the following statement:

```
mov ax,WORD PTR [myDouble+2] ; 1234h
```

FIGURE 4-7 Memory layout of myDouble.

Doubleword	Word	Byte	Offset	
12345678	5678	78	0000	myDouble
		56	0001	myDouble + 1
	1234	34	0002	myDouble + 2
		12	0003	myDouble + 3

Similarly, we could use the BYTE PTR operator to move a single byte from **myDouble** to BL:

```
mov    bl, BYTE PTR myDouble        ; 78h
```

Note that PTR must be used in combination with one of the standard assembler data types, BYTE, SBYTE, WORD, SWORD, DWORD, SDWORD, FWORD, QWORD, or TBYTE.

*Moving Smaller Values into Larger Destinations* We might want to move two smaller values from memory to a larger destination operand. In the next example, the first word is copied to the lower half of EAX and the second word is copied to the upper half. The DWORD PTR operator makes this possible:

```
.data
wordList WORD 5678h,1234h
.code
mov    eax, DWORD PTR wordList      ; EAX = 12345678h
```

#### 4.3.4 TYPE Operator

The TYPE operator returns the size, in bytes, of a single element of a variable. For example, the TYPE of a byte equals 1, the TYPE of a word equals 2, the TYPE of a doubleword is 4, and the TYPE of a quadword is 8. Here are examples of each:

```
.data
var1 BYTE ?
var2 WORD ?
var3 DWORD ?
var4 QWORD ?
```

The following table shows the value of each TYPE expression.

Expression	Value
TYPE var1	1
TYPE var2	2
TYPE var3	4
TYPE var4	8

### 4.3.5 LENGTHOF Operator

The LENGTHOF operator counts the number of elements in an array, defined by the values appearing on the same line as its label. We will use the following data as an example:

```
.data
byte1    BYTE    10,20,30
array1   WORD    30 DUP(?) , 0,0
array2   WORD    5 DUP(3 DUP(?))
array3   DWORD   1,2,3,4
digitStr BYTE    "12345678",0
```

When nested DUP operators are used in an array definition, LENGTHOF returns the product of the two counters. The following table lists the values returned by each LENGTHOF expression:

Expression	Value
LENGTHOF byte1	3
LENGTHOF array1	30 + 2
LENGTHOF array2	5 * 3
LENGTHOF array3	4
LENGTHOF digitStr	9

If you declare an array that spans multiple program lines, LENGTHOF only regards the data from the first line as part of the array. Given the following data, LENGTHOF myArray would return the value 5:

```
myArray BYTE 10,20,30,40,50
        BYTE 60,70,80,90,100
```

Alternatively, you can end the first line with a comma and continue the list of initializers onto the next line. Given the following data, LENGTHOF myArray would return the value 10:

```
myArray BYTE 10,20,30,40,50,
        60,70,80,90,100
```

### 4.3.6 SIZEOF Operator

The SIZEOF operator returns a value that is equivalent to multiplying LENGTHOF by TYPE. In the following example, **intArray** has TYPE = 2 and LENGTHOF = 32. Therefore, SIZEOF **intArray** equals 64:

```
.data
intArray WORD 32 DUP(0)
.code
mov eax,SIZEOF intArray      ; EAX = 64
```

### 4.3.7 LABEL Directive

The LABEL directive lets you insert a label and give it a size attribute without allocating any storage. All standard size attributes can be used with LABEL, such as BYTE, WORD, DWORD, QWORD or TBYTE. A common use of LABEL is to provide an alternative name and size

attribute for the variable declared next in the data segment. In the following example, we declare a label just before **val32** named **val16** and give it a **WORD** attribute:

```
.data
val16 LABEL WORD
val32 DWORD 12345678h
.code
mov ax,val16           ; AX = 5678h
mov dx,[val16+2]     ; DX = 1234h
```

**val16** is an alias for the same storage location as **val32**. The **LABEL** directive itself allocates no storage.

Sometimes we need to construct a larger integer from two smaller integers. In the next example, a 32-bit value is loaded into **EAX** from two 16-bit variables:

```
.data
LongValue LABEL DWORD
val1 WORD 5678h
val2 WORD 1234h
.code
mov eax,LongValue     ; EAX = 12345678h
```

### 4.3.8 Section Review

1. (*True/False*): The **OFFSET** operator always returns a 16-bit value.
2. (*True/False*): The **PTR** operator returns the 32-bit address of a variable.
3. (*True/False*): The **TYPE** operator returns a value of 4 for doubleword operands.
4. (*True/False*): The **LENGTHOF** operator returns the number of bytes in an operand.
5. (*True/False*): The **SIZEOF** operator returns the number of bytes in an operand.

## 4.4 Indirect Addressing

Direct addressing is rarely used for array processing because it is impractical to use constant offsets to address more than a few array elements. Instead, we use a register as a pointer (called *indirect addressing*) and manipulate the register's value. When an operand uses indirect addressing, it is called an *indirect operand*.

### 4.4.1 Indirect Operands

*Protected Mode* An indirect operand can be any 32-bit general-purpose register (**EAX**, **EBX**, **ECX**, **EDX**, **ESI**, **EDI**, **EBP**, and **ESP**) surrounded by brackets. The register is assumed to contain the address of some data. In the next example, **ESI** contains the offset of **byteVal**. The **MOV** instruction uses the indirect operand as the source, the offset in **ESI** is dereferenced, and a byte is moved to **AL**:

```
.data
byteVal BYTE 10h
.code
mov esi,OFFSET byteVal
mov al,[esi]           ; AL = 10h
```



If the destination operand uses indirect addressing, a new value is placed in memory at the location pointed to by the register. In the following example, the contents of the BL register are copied to the memory location addressed by ESI.

```
mov [esi],bl
```

*Using PTR with Indirect Operands* The size of an operand may not be evident from the context of an instruction. The following instruction causes the assembler to generate an “operand must have size” error message:

```
inc [esi] ; error: operand must have size
```

The assembler does not know whether ESI points to a byte, word, doubleword, or some other size. The PTR operator confirms the operand size:

```
inc BYTE PTR [esi]
```

#### 4.4.2 Arrays

Indirect operands are ideal tools for stepping through arrays. In the next example, **arrayB** contains 3 bytes. As ESI is incremented, it points to each byte, in order:

```
.data
arrayB BYTE 10h,20h,30h
.code
mov esi,OFFSET arrayB
mov al,[esi] ; AL = 10h
inc esi
mov al,[esi] ; AL = 20h
inc esi
mov al,[esi] ; AL = 30h
```

If we use an array of 16-bit integers, we add 2 to ESI to address each subsequent array element:

```
.data
arrayW WORD 1000h,2000h,3000h
.code
mov esi,OFFSET arrayW
mov ax,[esi] ; AX = 1000h
add esi,2
mov ax,[esi] ; AX = 2000h
add esi,2
mov ax,[esi] ; AX = 3000h
```

Suppose **arrayW** is located at offset 10200h. The following illustration shows the initial value of ESI in relation to the array data:

Offset	Value
10200	1000h
10202	2000h
10204	3000h

← [esi]

*Example: Adding 32-Bit Integers* The following code example adds three doublewords. A displacement of 4 must be added to ESI as it points to each subsequent array value because doublewords are 4 bytes long:

```
.data
arrayD DWORD 10000h,20000h,30000h
.code
mov esi,OFFSET arrayD
mov eax,[esi]           ; first number
add esi,4
add eax,[esi]           ; second number
add esi,4
add eax,[esi]           ; third number
```

Suppose **arrayD** is located at offset 10200h. Then the following illustration shows the initial value of ESI in relation to the array data:

Offset	Value	
10200	10000h	← [esi]
10204	20000h	← [esi] + 4
10208	30000h	← [esi] + 8

### 4.4.3 Indexed Operands

An *indexed operand* adds a constant to a register to generate an effective address. Any of the 32-bit general-purpose registers may be used as index registers. There are different notational forms permitted by MASM (the brackets are part of the notation):

```
constant[reg]
[constant + reg]
```

The first notational form combines the name of a variable with a register. The variable name is translated by the assembler into a constant that represents the variable's offset. Here are examples that show both notational forms:

arrayB[esi]	[arrayB + esi]
arrayD[ebx]	[arrayD + ebx]

Indexed operands are ideally suited to array processing. The index register should be initialized to zero before accessing the first array element:

```
.data
arrayB BYTE 10h,20h,30h
.code
mov esi,0
mov al,arrayB[esi]           ; AL = 10h
```

The last statement adds ESI to the offset of **arrayB**. The address generated by the expression **[arrayB + ESI]** is dereferenced and the byte in memory is copied to AL.

**Adding Displacements** The second type of indexed addressing combines a register with a constant offset. The index register holds the base address of an array or structure, and the constant identifies offsets of various array elements. The following example shows how to do this with an array of 16-bit words:

```
.data
arrayW WORD 1000h,2000h,3000h
.code
mov esi,OFFSET arrayW
mov ax,[esi] ; AX = 1000h
mov ax,[esi+2] ; AX = 2000h
mov ax,[esi+4] ; AX = 3000h
```

**Using 16-Bit Registers** It is usual to use 16-bit registers as indexed operands in real-address mode. In that case, you are limited to using SI, DI, BX, or BP:

```
mov al,arrayB[si]
mov ax,arrayW[di]
mov eax,arrayD[bx]
```

As is the case with indirect operands, avoid using BP except when addressing data on the stack.

### Scale Factors in Indexed Operands

Indexed operands must take into account the size of each array element when calculating offsets. Using an array of doublewords, as in the following example, we multiply the subscript (3) by 4 (the size of a doubleword) to generate the offset of the array element containing 400h:

```
.data
arrayD DWORD 100h, 200h, 300h, 400h
.code
mov esi,3 * TYPE arrayD ; offset of arrayD[3]
mov eax,arrayD[esi] ; EAX = 400h
```

Intel designers wanted to make a common operation easier for compiler writers, so they provided a way for offsets to be calculated, using a *scale factor*. The scale factor is the size of the array component (word = 2, doubleword = 4, or quadword = 8). Let's revise our previous example by setting ESI to the array subscript (3) and multiplying ESI by the scale factor (4) for doublewords:

```
.data
arrayD DWORD 1,2,3,4
.code
mov esi,3 ; subscript
mov eax,arrayD[esi*4] ; EAX = 4
```

The TYPE operator can make the indexing more flexible should arrayD be redefined as another type in the future:

```

mov esi,3                                ; subscript
mov eax,arrayD[esi*TYPE arrayD]         ; EAX = 4

```

#### 4.4.4 Pointers

A variable containing the address of another variable is called a *pointer*. Pointers are a great tool for manipulating arrays and data structures because the address they hold can be modified at runtime. You might use a system call to allocate (reserve) a block of memory, for example, and save the address of that block in a variable. A pointer's size is affected by the processor's current mode (32-bit or 64-bit). In the following 32-bit code example, **ptrB** contains the offset of **arrayB**:

```

.data
arrayB byte 10h,20h,30h,40h
ptrB dword arrayB

```

Optionally, you can declare **ptrB** with the **OFFSET** operator to make the relationship clearer:

```
ptrB dword OFFSET arrayB
```

The 32-bit mode programs in this book use near pointers, so they are stored in doubleword variables. Here are two examples: **ptrB** contains the offset of **arrayB**, and **ptrW** contains the offset of **arrayW**:

```

arrayB   BYTE    10h,20h,30h,40h
arrayW   WORD    1000h,2000h,3000h
ptrB     DWORD   arrayB
ptrW     DWORD   arrayW

```

Optionally, you can use the **OFFSET** operator to make the relationship clearer:

```
ptrB     DWORD   OFFSET arrayB
ptrW     DWORD   OFFSET arrayW

```

High-level languages purposely hide physical details about pointers because their implementations vary among different machine architectures. In assembly language, because we deal with a single implementation, we examine and use pointers at the physical level. This approach helps to remove some of the mystery surrounding pointers.

#### Using the **TYPEDDEF** Operator

The **TYPEDDEF** operator lets you create a user-defined type that has all the status of a built-in type when defining variables. **TYPEDDEF** is ideal for creating pointer variables. For example, the following declaration creates a new data type **PBYTE** that is a pointer to bytes:

```
PBYTE TYPEDDEF PTR BYTE
```

This declaration would usually be placed near the beginning of a program, before the data segment. Then, variables could be defined using **PBYTE**:

```

.data
arrayB BYTE 10h,20h,30h,40h
ptr1   PBYTE ?                ; uninitialized
ptr2   PBYTE arrayB           ; points to an array

```

**Example Program: Pointers** The following program (*pointers.asm*) uses TYPDEF to create three pointer types (PBYTE, PWORD, PDWORD). It creates several pointers, assigns several array offsets, and dereferences the pointers:

```
TITLE Pointers                                (Pointers.asm)
.386
.model flat,stdcall
.stack 4096
ExitProcess proto,dwExitCode:dword

; Create user-defined types.
PBYTE  TYPEDEF PTR BYTE      ; pointer to bytes
PWORD  TYPEDEF PTR WORD      ; pointer to words
PDWORD TYPEDEF PTR DWORD     ; pointer to doublewords

.data
arrayB BYTE 10h,20h,30h
arrayW WORD 1,2,3
arrayD DWORD 4,5,6

; Create some pointer variables.
ptr1 PBYTE arrayB
ptr2 PWORD arrayW
ptr3 PDWORD arrayD

.code
main PROC
; Use the pointers to access data.
    mov esi,ptr1
    mov al,[esi]                ; 10h
    mov esi,ptr2
    mov ax,[esi]                ; 1
    mov esi,ptr3
    mov eax,[esi]              ; 4
    invoke ExitProcess,0
main ENDP
END main
```

#### 4.4.5 Section Review

1. (*True/False*): Any 32-bit general-purpose register can be used as an indirect operand.
2. (*True/False*): The EBX register is usually reserved for addressing the stack.
3. (*True/False*): The following instruction is invalid: `inc [esi]`
4. (*True/False*): The following is an indexed operand: `array[esi]`

*Use the following data definitions for Questions 5 and 6:*

```
myBytes  BYTE 10h,20h,30h,40h
myWords  WORD 8Ah,3Bh,72h,44h,66h
myDoubles DWORD 1,2,3,4,5
myPointer DWORD myDoubles
```

5. Fill in the requested register values on the right side of the following instruction sequence:

```

mov esi,OFFSET myBytes
mov al,[esi] ; a. AL =
mov al,[esi+3] ; b. AL =
mov esi,OFFSET myWords + 2
mov ax,[esi] ; c. AX =
mov edi,8
mov edx,[myDoubles + edi] ; d. EDX =
mov edx,myDoubles[edi] ; e. EDX =
mov ebx,myPointer
mov eax,[ebx+4] ; f. EAX =

```

6. Fill in the requested register values on the right side of the following instruction sequence:

```

mov esi,OFFSET myBytes
mov ax,[esi] ; a. AX =
mov eax,DWORD PTR myWords ; b. EAX =
mov esi,myPointer
mov ax,[esi+2] ; c. AX =
mov ax,[esi+6] ; d. AX =
mov ax,[esi-4] ; e. AX =

```

## 4.5 JMP and LOOP Instructions

By default, the CPU loads and executes programs sequentially. But the current instruction might be *conditional*, meaning that it transfers control to a new location in the program based on the values of CPU status flags (Zero, Sign, Carry, etc.). Assembly language programs use conditional instructions to implement high-level statements such as IF statements and loops. Each of the conditional statements involves a possible transfer of control (jump) to a different memory address. A *transfer of control*, or *branch*, is a way of altering the order in which statements are executed. There are two basic types of transfers:

- **Unconditional Transfer:** Control is transferred to a new location in all cases; a new address is loaded into the instruction pointer, causing execution to continue at the new address. The JMP instruction does this.
- **Conditional Transfer:** The program branches if a certain condition is true. A wide variety of conditional transfer instructions can be combined to create conditional logic structures. The CPU interprets true/false conditions based on the contents of the ECX and Flags registers.

### 4.5.1 JMP Instruction

The JMP instruction causes an unconditional transfer to a destination, identified by a code label that is translated by the assembler into an offset. The syntax is

```
JMP destination
```

When the CPU executes an unconditional transfer, the offset of *destination* is moved into the instruction pointer, causing execution to continue at the new location.

**Creating a Loop** The JMP instruction provides an easy way to create a loop by jumping to a label at the top of the loop:

```
top:
    .
    .
    jmp top                ; repeat the endless loop
```

JMP is unconditional, so a loop like this will continue endlessly unless another way is found to exit the loop.

### 4.5.2 LOOP Instruction

The LOOP instruction, formally known as *Loop According to ECX Counter*, repeats a block of statements a specific number of times. ECX is automatically used as a counter and is decremented each time the loop repeats. Its syntax is

```
LOOP destination
```

The loop destination must be within  $-128$  to  $+127$  bytes of the current location counter. The execution of the LOOP instruction involves two steps: First, it subtracts 1 from ECX. Next, it compares ECX to zero. If ECX is not equal to zero, a jump is taken to the label identified by *destination*. Otherwise, if ECX equals zero, no jump takes place, and control passes to the instruction following the loop.

In real-address mode, CX is the default loop counter for the LOOP instruction. On the other hand, the LOOPD instruction uses ECX as the loop counter, and the LOOPW instruction uses CX as the loop counter.

In the following example, we add 1 to AX each time the loop repeats. When the loop ends, AX = 5 and ECX = 0:

```
    mov ax,0
    mov ecx,5
L1:  inc ax
     loop L1
```

A common programming error is to inadvertently initialize ECX to zero before beginning a loop. If this happens, the LOOP instruction decrements ECX to FFFFFFFFh, and the loop repeats 4,294,967,296 times! If CX is the loop counter (in real-address mode), it repeats 65,536 times.

Occasionally, you might create a loop that is large enough to exceed the allowed relative jump range of the LOOP instruction. Following is an example of an error message generated by MASM because the target label of a LOOP instruction was too far away:

```
error A2075: jump destination too far : by 14 byte(s)
```

Rarely should you explicitly modify ECX inside a loop. If you do, the LOOP instruction may not work as expected. In the following example, ECX is incremented within the loop. It never reaches zero, so the loop never stops:

```

top:
    .
    .
    inc ecx
    loop top

```

If you need to modify ECX inside a loop, you can save it in a variable at the beginning of the loop and restore it just before the LOOP instruction:

```

.data
count DWORD ?
.code
    mov ecx,100                ; set loop count
top:
    mov count,ecx              ; save the count
    .
    mov ecx,20                  ; modify ECX
    .
    mov ecx,count              ; restore loop count
    loop top

```

**Nested Loops** When creating a loop inside another loop, special consideration must be given to the outer loop counter in ECX. You can save it in a variable:

```

.data
count DWORD ?
.code
    mov ecx,100                ; set outer loop count
L1:
    mov count,ecx              ; save outer loop count
    mov ecx,20                  ; set inner loop count
L2:
    .
    .
    loop L2                     ; repeat the inner loop
    mov ecx,count              ; restore outer loop count
    loop L1                     ; repeat the outer loop

```

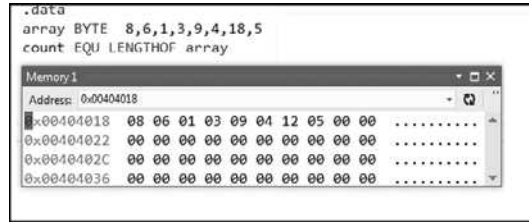
As a general rule, nested loops more than two levels deep are difficult to write. If the algorithm you're using requires deep loop nesting, move some of the inner loops into subroutines.

### 4.5.3 Displaying an Array in the Visual Studio Debugger

In a debugging session, if you want to display the contents of an array, here's how to do it: From the *Debug* menu, select *Windows*, select *Memory*, then select *Memory 1*. A memory window will appear, and you can use the mouse to drag and dock it to any side of the Visual Studio workspace. You can also right-click the window's title bar and indicate that you want the window to float above the editor window. In the *Address* field at the top of the memory window, type the & (ampersand) character, followed by the name of the array, and press *Enter*. For example, **&myArray** would be a valid address expression. The memory window will display a block of memory starting at the array's address. Figure 4-8 shows an example.

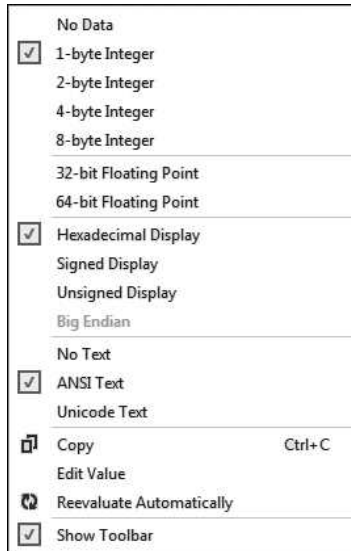


FIGURE 4–8 Using the debugger’s memory window to display an array.



If your array values are doublewords, you can right-click inside the memory window and select *4-byte integer* from the popup menu. You can also select from different formats, including *Hexadecimal Display*, signed decimal integer (called *Signed Display*), or unsigned decimal integer (called *Unsigned Display*) formats. The full set of choices is shown in Figure 4-9.

FIGURE 4–9 Popup menu for the debugger’s memory window.



#### 4.5.4 Summing an Integer Array

There’s hardly any task more common in beginning programming than calculating the sum of the elements in an array. In assembly language, you would follow these steps:

1. Assign the array’s address to a register that will serve as an indexed operand.
2. Initialize the loop counter to the length of the array.
3. Assign zero to the register that accumulates the sum.
4. Create a label to mark the beginning of the loop.
5. In the loop body, add a single array element to the sum.
6. Point to the next array element.
7. Use a LOOP instruction to repeat the loop.

Steps 1 through 3 may be performed in any order. Here's a short program that sums an array of 16-bit integers.

```

; Summing an Array                                (SumArray.asm)
.386
.model flat,stdcall
.stack 4096
ExitProcess proto,dwExitCode:dword
.data
intarray DWORD 10000h,20000h,30000h,40000h

.code
main PROC
    mov  edi,OFFSET intarray      ; 1: EDI = address of intarray
    mov  ecx,LENGTHOF intarray    ; 2: initialize loop counter
    mov  eax,0                    ; 3: sum = 0
L1:    ; 4: mark beginning of loop
    add  eax,[edi]                ; 5: add an integer
    add  edi,TYPE intarray        ; 6: point to next element
    loop L1                       ; 7: repeat until ECX = 0

    invoke ExitProcess,0
main ENDP
END main

```

#### 4.5.5 Copying a String

Programs often copy large blocks of data from one location to another. The data may be arrays or strings, but they can contain any type of objects. Let's see how this can be done in assembly language, using a loop that copies a string, represented as an array of bytes with a null terminator value. Indexed addressing works well for this type of operation because the same index register references both strings. The target string must have enough available space to receive the copied characters, including the null byte at the end:

```

; Copying a String                                (CopyStr.asm)
.386
.model flat,stdcall
.stack 4096
ExitProcess proto,dwExitCode:dword
.data
source BYTE "This is the source string",0
target BYTE SIZEOF source DUP(0)

.code
main PROC
    mov  esi,0                    ; index register
    mov  ecx,SIZEOF source        ; loop counter
L1:    ;
    mov  al,source[esi]           ; get a character from source
    mov  target[esi],al           ; store it in the target
    inc  esi                      ; move to next character

```

```

        loop L1                ; repeat for entire string
        invoke ExitProcess,0
main ENDP
END main

```

The MOV instruction cannot have two memory operands, so each character is moved from the source string to AL, then from AL to the target string.

### 4.5.6 Section Review

1. (*True/False*): A JMP instruction can only jump to a label inside the current procedure.
2. (*True/False*): JMP is a conditional transfer instruction.
3. If ECX is initialized to zero before beginning a loop, how many times will the LOOP instruction repeat? (Assume ECX is not modified by any other instructions inside the loop.)
4. (*True/False*): The LOOP instruction first checks to see whether ECX is not equal to zero; then LOOP decrements ECX and jumps to the destination label.
5. (*True/False*): The LOOP instruction does the following: It decrements ECX; then, if ECX is not equal to zero, LOOP jumps to the destination label.
6. In real-address mode, which register is used as the counter by the LOOP instruction?
7. In real-address mode, which register is used as the counter by the LOOPD instruction?
8. (*True/False*): The target of a LOOP instruction must be within 256 bytes of the current location.
9. (*Challenge*): What will be the final value of EAX in this example?

```

        mov  eax,0
        mov  ecx,10                ; outer loop counter
L1:
        mov  eax,3
        mov  ecx,5                ; inner loop counter
L2:
        add  eax,5
        loop L2                ; repeat inner loop
        loop L1                ; repeat outer loop

```

10. Revise the code from the preceding question so the outer loop counter is not erased when the inner loop starts.

## 4.6 64-Bit Programming

### 4.6.1 MOV Instruction

The MOV instruction in 64-bit mode has a great deal in common with 32-bit mode. There are just a few differences, which we will discuss here. Immediate operands (constants) may be 8, 16, 32, or 64 bits. Here's a 64-bit example:

```

mov    rax,0ABCDEFGAFFFFFFFFh    ; 64-bit immediate operand

```

When you move a 32-bit constant to a 64-bit register, the upper 32 bits (bits 32–63) of the destination are cleared (equal to zero):

```
mov    rax,0FFFFFFFFh           ; rax = 00000000FFFFFFFF
```

When you move a 16-bit constant or an 8-bit constant into a 64-bit register, the upper bits are also cleared:

```
mov    rax,06666h              ; clears bits 16-63
mov    rax,055h                ; clears bits 8-63
```

When you move memory operands into 64-bit registers, however, the results are mixed. For example, moving a 32-bit memory operand into EAX (the lower half of RAX) causes the upper 32 bits in RAX to be cleared:

```
.data
myDword DWORD 80000000h
.code
mov    rax,0FFFFFFFFFFFFFFFFh
mov    eax,myDword             ; RAX = 0000000080000000
```

But when you move an 8-bit or a 16-bit memory operand into the lower bits of RAX, the highest bits in the destination register are not affected:

```
.data
myByte  BYTE 55h
myWord  WORD 6666h
.code
mov    ax,myWord              ; bits 16-63 are not affected
mov    al,myByte              ; bits 8-63 are not affected
```

The `MOVSXD` instruction (move with sign-extension) permits the source operand to be a 32-bit register or memory operand. The following instructions cause RAX to equal `FFFFFFFFFFFFFFFFh`:

```
mov    ebx,0FFFFFFFFh
movsxd rax,ebx
```

The `OFFSET` operator generates a 64-bit address, which must be held by a 64-bit register or variable. In the following example, we use the RSI register:

```
.data
myArray WORD 10,20,30,40
.code
mov    rsi,OFFSET myArray
```

The `LOOP` instruction in 64-bit mode uses the `RCX` register as the loop counter.

With these basic concepts, you can write quite a few programs in 64-bit mode. Most of the time, programming is easier if you consistently use 64-bit integer variables and 64-bit registers. ASCII strings are a special case because they always contain bytes. Usually, you use indirect or indexed addressing when processing them.

### 4.6.2 64-Bit Version of SumArray

Let's recreate the **SumArray** program in 64-bit mode. It calculates the sum of an array of 64-bit integers. First, we use the **QWORD** directive to create an array of quadwords. Then, we change all 32-bit register names to 64-bit names. This is the complete program listing:

```

; Summing an Array                                (SumArray_64.asm)

ExitProcess PROTO
.data
intarray QWORD 1000000000000h,2000000000000h
          QWORD 3000000000000h,4000000000000h

.code
main PROC
    mov rdi,OFFSET intarray    ; RDI = address of intarray
    mov rcx,LENGTHOF intarray ; initialize loop counter
    mov rax,0                  ; sum = 0
L1:                               ; mark beginning of loop
    add rax,[rdi]              ; add an integer
    add rdi,TYPE intarray      ; point to next element
    loop L1                    ; repeat until RCX = 0
    mov ecx,0                  ; ExitProcess return value
    call ExitProcess

main ENDP
END

```

### 4.6.3 Addition and Subtraction

The **ADD**, **SUB**, **INC**, and **DEC** instructions affect the CPU status flags in the same way in 64-bit mode as in 32-bit mode. In the following example, we add 1 to a 32-bit number in **RAX**. Each bit carries to the left, causing a 1 to be inserted in bit 32:

```

mov rax,0FFFFFFFh    ; fill the lower 32 bits
add rax,1            ; RAX = 100000000h

```

It always pays to know the sizes of your operands. When you use a partial register operand, be aware that the remainder of the register is not modified. In the next example, the 16-bit sum in **AX** rolls over to zero without affecting the upper bits in **RAX**. This happens because the operation uses 16-bit registers (**AX** and **BX**):

```

mov rax,0FFFFh      ; RAX = 000000000000FFFF
mov bx,1
add ax,bx            ; RAX = 0000000000000000

```

Similarly, in the following example, the sum in **AL** does not carry into any other bits within **RAX**. After the **ADD**, **RAX** equals zero:

```

mov rax,0FFh        ; RAX = 00000000000000FF
mov bl,1
add al,bl           ; RAX = 0000000000000000

```

The same principle applies to subtraction. In the following code excerpt, subtracting 1 from zero in **EAX** causes the lower 32 bits of **RAX** to become equal to  $-1$  (**FFFFFFFFh**). Similarly, subtracting 1 from zero in **AX** causes the lower 16 bits of **RAX** to become equal to  $-1$  (**FFFFh**).

```

mov  rax,0                ; RAX = 0000000000000000
mov  ebx,1
sub  eax,ebx              ; RAX = 00000000FFFFFFFF
mov  rax,0                ; RAX = 0000000000000000
mov  bx,1
sub  ax,bx                ; RAX = 000000000000FFFF

```

A 64-bit general-purpose register must be used when an instruction contains an indirect operand. Remember that you must use the PTR operator to clarify the target operand's size. Here are examples, including one with a 64-bit target:

```

dec  BYTE PTR [rdi]      ; 8-bit target
inc  WORD PTR [rbx]     ; 16-bit target
inc  QWORD PTR [rsi]    ; 64-bit target

```

In 64-bit mode, you can use scale factors in indexed operands, just as you do in 32-bit mode. If you're working with an array of 64-bit integers, use a scale factor of 8. Here's an example

```

.data
array QWORD 1,2,3,4
.code
mov  esi,3                ; subscript
mov  eax,array[rsi*8]     ; EAX = 4

```

In 64-bit mode, a pointer variable holds a 64-bit offset. In the following example, the **ptrB** variable holds the offset of arrayB:

```

.data
arrayB BYTE 10h,20h,30h,40h
ptrB QWORD arrayB

```

Optionally, you can declare ptrB with the OFFSET operator to make the relationship clearer:

```
ptrB QWORD OFFSET arrayB
```

#### 4.6.4 Section Review

1. (*True/False*): Moving a constant value of 0FFh to the RAX register clears bits 8 through 63.
2. (*True/False*): A 32-bit constant may be moved to a 64-bit register, but 64-bit constants are not permitted.
3. What value will RCX contain after executing the following instructions?

```

mov  rcx,1234567800000000h
sub  ecx,1

```

4. What value will RCX contain after executing the following instructions?

```

mov  rcx,1234567800000000h
add  rcx,0ABABABAh

```

5. What value will the AL register contain after executing the following instructions?

```

.data
bArray BYTE 10h,20h,30h,40h,50h
.code

```

```

mov  rdi,OFFSET bArray
dec  BYTE PTR [rdi+1]
inc  rdi
mov  al,[rdi]

```

6. What value will RCX contain after executing the following instructions?

```

mov  rcx,0DFFFh
mov  bx,3
add  cx,bx

```

## 4.7 Chapter Summary

MOV, a data transfer instruction, copies a source operand to a destination operand. The MOVZX instruction zero-extends a smaller operand into a larger one. The MOVSX instruction sign-extends a smaller operand into a larger one. The XCHG instruction exchanges the contents of two operands. At least one operand must be a register.

**Operand Types** The following types of operands are presented in this chapter:

- A *direct* operand is the name of a variable, and represents the variable's address.
- A *direct-offset* operand adds a displacement to the name of a variable, generating a new offset. This new offset can be used to access data in memory.
- An *indirect* operand is a register containing the address of data. By surrounding the register with brackets (as in [esi]), a program dereferences the address and retrieves the memory data.
- An *indexed* operand combines a constant with an indirect operand. The constant and register value are added, and the resulting offset is dereferenced. For example, [array+esi] and array[esi] are indexed operands.

The following arithmetic instructions are important:

- The INC instruction adds 1 to an operand.
- The DEC instruction subtracts 1 from an operand.
- The ADD instruction adds a source operand to a destination operand.
- The SUB instruction subtracts a source operand from a destination operand.
- The NEG instruction reverses the sign of an operand.

When converting simple arithmetic expressions to assembly language, use standard operator precedence rules to select which expressions to evaluate first.

**Status Flags** The following CPU status flags are affected by arithmetic operations:

- The Sign flag is set when the outcome of an arithmetic operation is negative.
- The Carry flag is set when the result of an unsigned arithmetic operation is too large for the destination operand.
- The Parity flag indicates whether or not an even number of 1 bits occurs in the least significant byte of the destination operand immediately after an arithmetic or boolean instruction has executed.
- The Auxiliary Carry flag is set when a carry or borrow occurs in bit position 3 of the destination operand.
- The Zero flag is set when the outcome of an arithmetic operation is zero.

- The Overflow flag is set when the result of a signed arithmetic operation is out of range for the destination operand.

**Operators** The following operators are common in assembly language:

- The OFFSET operator returns the distance (in bytes) of a variable from the beginning of its enclosing segment.
- The PTR operator overrides a variable's declared size.
- The TYPE operator returns the size (in bytes) of a single variable or of a single element in an array.
- The LENGTHOF operator returns the number of elements in an array.
- The SIZEOF operator returns the number bytes used by an array initializer.
- The TYPEDEF operator creates a user-defined type.

**Loops** The JMP (Jump) instruction unconditionally branches to another location. The LOOP (Loop According to ECX Counter) instruction is used in counting-type loops. In 32-bit mode, LOOP uses ECX as the counter; in 64-bit mode, RCX is the counter. In both modes, LOOPD uses ECX as the counter and LOOPW uses CX as the counter.

The MOV instruction works almost the same in 64-bit mode as in 32-bit mode. However, the rules for moving constants and memory operands to 64-bit registers are a bit tricky. Whenever possible, try to use 64-bit operands in 64-bit mode. Indirect and indexed operands always use 64-bit registers.

## 4.8 Key Terms

### 4.8.1 Terms

Auxiliary Carry flag	memory operand
Carry flag	Overflow flag
conditional transfer	Parity flag
data transfer instruction	pointer
direct memory operand	register operand
direct-offset operand	scale factor
effective address	sign extension
immediate operand	unconditional transfer
indexed operand	zero extension
indirect operand	Zero flag

### 4.8.2 Instructions, Operators, and Directives

ADD	JMP
ALIGN	LABEL
DEC	LOOP
INC	MOV



MOVSX	PTR
MOVZX	SAHF
NEG	SIZEOF
LABEL	SUB
LAHF	TYPE
LENGTHOF	TYPEDEF
OFFSET	XCHG

## 4.9 Review Questions and Exercises

### 4.9.1 Short Answer

1. What will be the value in EDX after each of the lines marked (a) and (b) execute?

```
.data
one WORD 8002h
two WORD 4321h
.code
mov  edx,21348041h
movsx edx,one           ; (a)
movsx edx,two          ; (b)
```

2. What will be the value in EAX after the following lines execute?

```
mov  eax,1002FFFFh
inc  ax
```

3. What will be the value in EAX after the following lines execute?

```
mov  eax,30020000h
dec  ax
```

4. What will be the value in EAX after the following lines execute?

```
mov  eax,1002FFFFh
neg  ax
```

5. What will be the value of the Parity flag after the following lines execute?

```
mov  al,1
add  al,3
```

6. What will be the value of EAX and the Sign flag after the following lines execute?

```
mov  eax,5
sub  eax,6
```

7. In the following code, the value in AL is intended to be a signed byte. Explain how the Overflow flag helps, or does not help you, to determine whether the final value in AL falls within a valid signed range.

```
mov  al,-1
add  al,130
```

8. What value will RAX contain after the following instruction executes?

```
mov rax,44445555h
```

9. What value will RAX contain after the following instructions execute?

```
.data
dwordVal DWORD 84326732h
.code
mov rax,0FFFFFFFF00000000h
mov rax,dwordVal
```

10. What value will EAX contain after the following instructions execute?

```
.data
dVal DWORD 12345678h
.code
mov ax,3
mov WORD PTR dVal+2,ax
mov eax,dVal
```

11. What will EAX contain after the following instructions execute?

```
.data
.dVal DWORD ?
.code
mov dVal,12345678h
mov ax,WORD PTR dVal+2
add ax,3
mov WORD PTR dVal,ax
mov eax,dVal
```

12. (*Yes/No*): Is it possible to set the Overflow flag if you add a positive integer to a negative integer?
13. (*Yes/No*): Will the Overflow flag be set if you add a negative integer to a negative integer and produce a positive result?
14. (*Yes/No*): Is it possible for the NEG instruction to set the Overflow flag?
15. (*Yes/No*): Is it possible for both the Sign and Zero flags to be set at the same time?

Use the following variable definitions for Questions 16–19:

```
.data
var1 SBYTE -4,-2,3,1
var2 WORD 1000h,2000h,3000h,4000h
var3 SWORD -16,-42
var4 DWORD 1,2,3,4,5
```

16. For each of the following statements, state whether or not the instruction is valid:

- mov ax,var1?
- mov ax,var2
- mov eax,var3
- mov var2,var3
- movzx ax,var2
- movzx var2,al

```
g. mov ds,ax
h. mov ds,1000h
```

17. What will be the hexadecimal value of the destination operand after each of the following instructions execute in sequence?

```
mov al,var1 ; a.
mov ah,[var1+3] ; b.
```

18. What will be the value of the destination operand after each of the following instructions execute in sequence?

```
mov ax,var2 ; a.
mov ax,[var2+4] ; b.
mov ax,var3 ; c.
mov ax,[var3-2] ; d.
```

19. What will be the value of the destination operand after each of the following instructions execute in sequence?

```
mov edx,var4 ; a.
movzx edx,var2 ; b.
mov edx,[var4+4] ; c.
movsx edx,var1 ; d.
```

#### 4.9.2 Algorithm Workbench

- Write a sequence of MOV instructions that will exchange the upper and lower words in a doubleword variable named **three**.
- Using the XCHG instruction no more than three times, reorder the values in four 8-bit registers from the order A,B,C,D to B,C,D,A.
- Transmitted messages often include a parity bit whose value is combined with a data byte to produce an even number of 1 bits. Suppose a message byte in the AL register contains 01110101. Show how you could use the Parity flag combined with an arithmetic instruction to determine if this message byte has even or odd parity.
- Write code using byte operands that adds two negative integers and causes the Overflow flag to be set.
- Write a sequence of two instructions that use addition to set the Zero and Carry flags at the same time.
- Write a sequence of two instructions that set the Carry flag using subtraction.
- Implement the following arithmetic expression in assembly language:  $EAX = -val2 + 7 - val3 + val1$ . Assume that val1, val2, and val3 are 32-bit integer variables.
- Write a loop that iterates through a doubleword array and calculates the sum of its elements using a scale factor with indexed addressing.
- Implement the following expression in assembly language:  $AX = (val2 + BX) - val4$ . Assume that val2 and val4 are 16-bit integer variables.
- Write a sequence of two instructions that set both the Carry and Overflow flags at the same time.
- Write a sequence of instructions showing how the Zero flag could be used to indicate unsigned overflow after executing INC and DEC instructions.

Use the following data definitions for Questions 12–18:

```
.data
myBytes  BYTE 10h,20h,30h,40h
myWords  WORD 3 DUP(?),2000h
myString BYTE "ABCDE"
```

12. Insert a directive in the given data that aligns **myBytes** to an even-numbered address.
13. What will be the value of EAX after each of the following instructions execute?
 

mov  eax,TYPE myBytes	;	a.
mov  eax,LENGTHOF myBytes	;	b.
mov  eax,SIZEOF myBytes	;	c.
mov  eax,TYPE myWords	;	d.
mov  eax,LENGTHOF myWords	;	e.
mov  eax,SIZEOF myWords	;	f.
mov  eax,SIZEOF myString	;	g.
14. Write a single instruction that moves the first two bytes in **myBytes** to the DX register. The resulting value will be 2010h.
15. Write an instruction that moves the second byte in **myWords** to the AL register.
16. Write an instruction that moves all four bytes in **myBytes** to the EAX register.
17. Insert a LABEL directive in the given data that permits **myWords** to be moved directly to a 32-bit register.
18. Insert a LABEL directive in the given data that permits **myBytes** to be moved directly to a 16-bit register.

## 4.10 Programming Exercises

The following exercises may be completed in either 32-bit mode or 64-bit mode.

### ★ 1. Converting from Big Endian to Little Endian

Write a program that uses the variables below and MOV instructions to copy the value from **bigEndian** to **littleEndian**, reversing the order of the bytes. The number's 32-bit value is understood to be 12345678 hexadecimal.

```
.data
bigEndian BYTE 12h,34h,56h,78h
littleEndian DWORD?
```

### ★★ 2. Exchanging Pairs of Array Values

Write a program with a loop and indexed addressing that exchanges every pair of values in an array with an even number of elements. Therefore, item  $i$  will exchange with item  $i+1$ , and item  $i+2$  will exchange with item  $i+3$ , and so on.

### ★★ 3. Summing the Gaps between Array Values

Write a program with a loop and indexed addressing that calculates the sum of all the gaps between successive array elements. The array elements are doublewords, sequenced in nondecreasing order. So, for example, the array  $\{0, 2, 5, 9, 10\}$  has gaps of 2, 3, 4, and 1, whose sum equals 10.

**★★ 4. Copying a Word Array to a DoubleWord array**

Write a program that uses a loop to copy all the elements from an unsigned Word (16-bit) array into an unsigned doubleword (32-bit) array.

**★★ 5. Fibonacci Numbers**

Write a program that uses a loop to calculate the first seven values of the Fibonacci number sequence, described by the following formula:  $\text{Fib}(1) = 1$ ,  $\text{Fib}(2) = 1$ ,  $\text{Fib}(n) = \text{Fib}(n - 1) + \text{Fib}(n - 2)$ .

**★★★ 6. Reverse an Array**

Use a loop with indirect or indexed addressing to reverse the elements of an integer array in place. Do not copy the elements to any other array. Use the `SIZEOF`, `TYPE`, and `LENGTHOF` operators to make the program as flexible as possible if the array size and type should be changed in the future.

**★★★ 7. Copy a String in Reverse Order**

Write a program with a loop and indirect addressing that copies a string from **source** to **target**, reversing the character order in the process. Use the following variables:

```
source BYTE "This is the source string",0
target BYTE SIZEOF source DUP('#')
```

**★★★ 8. Shifting the Elements in an Array**

Using a loop and indexed addressing, write code that rotates the members of a 32-bit integer array forward one position. The value at the end of the array must wrap around to the first position. For example, the array [10,20,30,40] would be transformed into [40,10,20,30].

---

# PROCEDURES

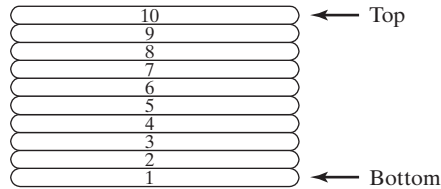
- 5.1 **Stack Operations**
  - 5.1.1 Runtime Stack (32-Bit Mode)
  - 5.1.2 PUSH and POP Instructions
  - 5.1.3 Section Review
- 5.2 **Defining and Using Procedures**
  - 5.2.1 PROC Directive
  - 5.2.2 CALL and RET Instructions
  - 5.2.3 Nested Procedure Calls
  - 5.2.4 Passing Register Arguments to Procedures
  - 5.2.5 Example: Summing an Integer Array
  - 5.2.6 Saving and Restoring Registers
  - 5.2.7 Section Review
- 5.3 **Linking to an External Library**
  - 5.3.1 Background Information
  - 5.3.2 Section Review
- 5.4 **The Irvine32 Library**
  - 5.4.1 Motivation for Creating the Library
  - 5.4.2 Overview
  - 5.4.3 Individual Procedure Descriptions
  - 5.4.4 Library Test Programs
  - 5.4.5 Section Review
- 5.5 **64-Bit Assembly Programming**
  - 5.5.1 The *Irvine64* Library
  - 5.5.2 Calling 64-Bit Subroutines
  - 5.5.3 The x64 Calling Convention
  - 5.5.4 Sample Program that Calls a Procedure
- 5.6 **Chapter Summary**
- 5.7 **Key Terms**
  - 5.7.1 Terms
  - 5.7.2 Instructions, Operators, and Directives
- 5.8 **Review Questions and Exercises**
  - 5.8.1 Short Answer
  - 5.8.2 Algorithm Workbench
- 5.9 **Programming Exercises**

This chapter introduces you to procedures, also known subroutines and functions. Any program of reasonable size needs to be divided into parts, and certain parts need to be used more than once. You will see that parameters can be passed in registers, and you will learn about the runtime stack that the CPU uses to track the calling location of procedures. Finally, we will introduce you to two code libraries supplied with this book, named *Irvine32* and *Irvine64*, containing useful utilities that simplify input–output.

## 5.1 Stack Operations

If we place ten plates on each other as in the following diagram, the result can be called a stack. While it might be possible to remove a dish from the middle of the stack, it is much more common to remove from the top. New plates can be added to the top of the stack, but never to the bottom or middle (Fig. 5-1):

FIGURE 5-1 Stack of plates



A *stack data structure* follows the same principle as a stack of plates: New values are added to the top of the stack, and existing values are removed from the top. Stacks in general are useful structures for a variety of programming applications, and they can easily be implemented using object-oriented programming methods. If you have taken a programming course that used data structures, you have worked with the *stack abstract data type*. A stack is also called a LIFO structure (*Last-In, First-Out*) because the last value put into the stack is always the first value taken out.

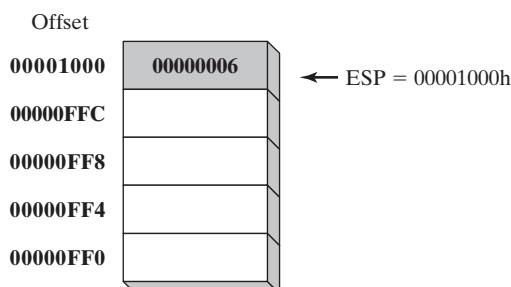
In this chapter, we concentrate specifically on the *runtime stack*. It is supported directly by hardware in the CPU, and it is an essential part of the mechanism for calling and returning from procedures. Most of the time, we just call it the stack.

### 5.1.1 Runtime Stack (32-Bit Mode)

The *runtime stack* is a memory array managed directly by the CPU, using the ESP (extended stack pointer) register, known as the *stack pointer register*. In 32-bit mode, ESP register holds a 32-bit offset into some location on the stack. We rarely manipulate ESP directly; instead, it is indirectly modified by instructions such as CALL, RET, PUSH, and POP.

ESP always points to the last value to be added to, or *pushed* on, the top of stack. To demonstrate, let's begin with a stack containing one value. In Fig. 5-2, the ESP contains hexadecimal 00001000, the offset of the most recently pushed value (00000006). In our diagrams, the top of the stack moves downward when the stack pointer decreases in value:

FIGURE 5-2 A stack containing a single value



Each stack location in this figure contains 32 bits, which is the case when a program is running in 32-bit mode.

The runtime stack discussed here is not the same as the *stack abstract data type* (ADT) discussed in data structures courses. The runtime stack works at the system level to handle subroutine calls. The stack ADT is a programming construct typically written in a high-level programming language such as C++ or Java. It is used when implementing algorithms that depend on last-in, first-out operations.

**Push Operation**

A 32-bit *push operation* decrements the stack pointer by 4 and copies a value into the location in the stack pointed to by the stack pointer. Figure 5-3 shows the effect of pushing 000000A5 on a stack that already contains one value (00000006). Notice that the ESP register always points to the last item pushed on the stack. The figure shows the stack ordering opposite to that of the stack of plates we saw earlier, because the runtime stack grows downward in memory, from higher addresses to lower addresses. Before the push, ESP = 00001000h; after the push, ESP = 0000FFCh. Figure 5-4 shows the same stack after pushing a total of four integers.

FIGURE 5-3 Pushing integers on the stack.

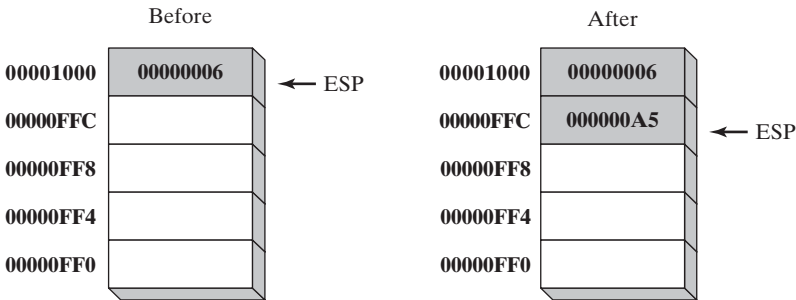
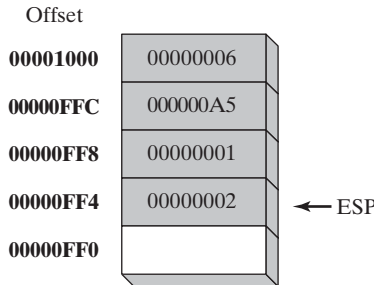


FIGURE 5-4 Stack, after pushing 00000001 and 00000002.

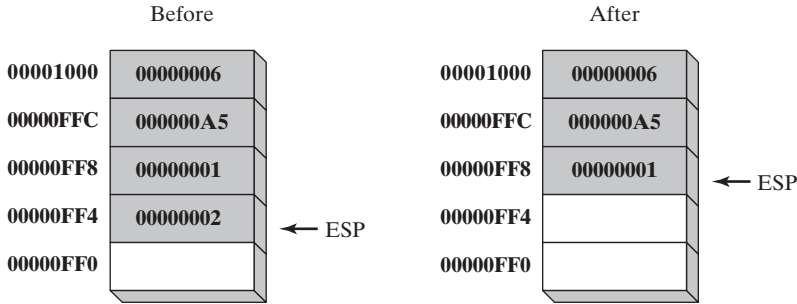


**Pop Operation**

A *pop operation* removes a value from the stack. After the value is popped from the stack, the stack pointer is incremented (by the stack element size) to point to the next-highest location in the stack. Figure 5-5 shows the stack before and after the value 00000002 is popped.



FIGURE 5-5 Popping a value from the runtime stack.



The area of the stack below ESP is logically empty, and will be overwritten the next time the current program executes any instruction that pushes a value on the stack.

### Stack Applications

There are several important uses of runtime stacks in programs:

- A stack makes a convenient temporary save area for registers when they are used for more than one purpose. After they are modified, they can be restored to their original values.
- When the CALL instruction executes, the CPU saves the current subroutine's return address on the stack.
- When calling a subroutine, you pass input values called *arguments* by pushing them on the stack.
- The stack provides temporary storage for local variables inside subroutines.

#### 5.1.2 PUSH and POP Instructions

##### PUSH Instruction

The PUSH instruction first decrements ESP and then copies a source operand into the stack. A 16-bit operand causes ESP to be decremented by 2. A 32-bit operand causes ESP to be decremented by 4. There are three instruction formats:

```
PUSH reg/mem16
PUSH reg/mem32
PUSH imm32
```

##### POP Instruction

The POP instruction first copies the contents of the stack element pointed to by ESP into a 16- or 32-bit destination operand and then increments ESP. If the operand is 16 bits, ESP is incremented by 2; if the operand is 32 bits, ESP is incremented by 4:

```
POP reg/mem16
POP reg/mem32
```

##### PUSHFD and POPFD Instructions

The PUSHFD instruction pushes the 32-bit EFLAGS register on the stack, and POPFD pops the stack into EFLAGS:

```
pushfd
popfd
```

The MOV instruction cannot be used to copy the flags to a variable, so PUSHFD may be the best way to save the flags. There are times when it is useful to make a backup copy of the flags so you can restore them to their former values later. Often, we enclose a block of code within PUSHFD and POPFD:

```

pushfd                ; save the flags
;
; any sequence of statements here...
;
popfd                 ; restore the flags

```

When using pushes and pops of this type, be sure the program's execution path does not skip over the POPFD instruction. When a program is modified over time, it can be tricky to remember where all the pushes and pops are located. The need for precise documentation is critical!

A less error-prone way to save and restore the flags is to push them on the stack and immediately pop them into a variable:

```

.data
saveFlags DWORD ?
.code
pushfd                ; push flags on stack
pop saveFlags         ; copy into a variable

```

The following statements restore the flags from the same variable:

```

push saveFlags        ; push saved flag values
popfd                 ; copy into the flags

```

### ***PUSHAD, PUSHA, POPAD, and POPA***

The PUSHAD instruction pushes all of the 32-bit general-purpose registers on the stack in the following order: EAX, ECX, EDX, EBX, ESP (value before executing PUSHAD), EBP, ESI, and EDI. The POPAD instruction pops the same registers off the stack in reverse order. Similarly, the PUSHA instruction, pushes the 16-bit general-purpose registers (AX, CX, DX, BX, SP, BP, SI, DI) on the stack in the order listed. The POPA instruction pops the same registers in reverse. You should only use PUSHA and POPA when programming in 16-bit mode. We cover 16-bit programming in Chapters 14–17.

If you write a procedure that modifies a number of 32-bit registers, use PUSHAD at the beginning of the procedure and POPAD at the end to save and restore the registers. The following code fragment is an example:

```

MySub PROC
    pushad                ; save general-purpose registers
    .
    .
    mov eax,...
    mov edx,...
    mov ecx,...
    .
    .
    popad                 ; restore general-purpose registers
    ret
MySub ENDP

```

An important exception to the foregoing example must be pointed out; procedures returning results in one or more registers should not use PUSHAD and PUSHA. Suppose the following **ReadValue** procedure returns an integer in EAX; the call to POPAD overwrites the return value from EAX:

```

ReadValue PROC
    pushad                ; save general-purpose registers
    .
    .
    mov    eax,return_value
    .
    .
    popad                 ; overwrites EAX!
    ret
ReadValue ENDP

```

### **Example: Reversing a String**

Let's look at a program named *RevStr* that loops through a string and pushes each character on the stack. It then pops the letters from the stack (in reverse order) and stores them back into the same string variable. Because the stack is a LIFO (*last-in, first-out*) structure, the letters in the string are reversed:

```

; Reversing a String                (RevStr.asm)

.386
.model flat,stdcall
.stack 4096
ExitProcess PROTO,dwExitCode:DWORD

.data
aName BYTE "Abraham Lincoln",0
nameSize = ($ - aName) - 1

.code
main PROC
; Push the name on the stack.
    mov    ecx,nameSize
    mov    esi,0

L1: movzx  eax,aName[esi]           ; get character
    push  eax                       ; push on stack
    inc  esi
    loop  L1

; Pop the name from the stack, in reverse,
; and store in the aName array.
    mov    ecx,nameSize
    mov    esi,0

L2: pop    eax                       ; get character
    mov    aName[esi],al           ; store in string
    inc  esi

```

```

        loop L2
        INVOKE ExitProcess,0
main ENDP
END main

```

### 5.1.3 Section Review

1. Which register (in 32-bit mode) manages the stack?
2. How is the runtime stack different from the stack abstract data type?
3. Why is the stack called a LIFO structure?
4. When a 32-bit value is pushed on the stack, what happens to ESP?
5. (*True/False*): Local variables in procedures are created on the stack.
6. (*True/False*): The PUSH instruction cannot have an immediate operand.

## 5.2 Defining and Using Procedures

If you've already studied a high-level programming language, you know how useful it can be to divide programs into *subroutines*. A complicated problem is usually divided into separate tasks before it can be understood, implemented, and tested effectively. In assembly language, we typically use the term *procedure* to mean a subroutine. In other languages, subroutines are called methods or functions.

In terms of object-oriented programming, the functions or methods in a single class are roughly equivalent to the collection of procedures and data encapsulated in an assembly language module. Assembly language was created long before object-oriented programming, so it doesn't have the formal structure found in object-oriented languages. Assembly programmers must impose their own formal structure on programs.

### 5.2.1 PROC Directive

#### *Defining a Procedure*

Informally, we can define a *procedure* as a named block of statements that ends in a return statement. A procedure is declared using the PROC and ENDP directives. It must be assigned a name (a valid identifier). Each program we've written so far contains a procedure named **main**, for example,

```

main PROC
.
.
main ENDP

```

When you create a procedure other than your program's startup procedure, end it with a RET instruction. RET forces the CPU to return to the location from where the procedure was called:

```

sample PROC
.
.
ret
sample ENDP

```

### Labels in Procedures

By default, labels are visible only within the procedure in which they are declared. This rule often affects jump and loop instructions. In the following example, the label named *Destination* must be located in the same procedure as the JMP instruction:

```
    jmp Destination
```

It is possible to work around this limitation by declaring a *global label*, identified by a double colon (::) after its name:

```
Destination::
```

In terms of program design, it's not a good idea to jump or loop outside of the current procedure. Procedures have an automated way of returning and adjusting the runtime stack. If you directly transfer out of a procedure, the runtime stack can easily become corrupted. For more information about the runtime stack, see Section 8.2.

### Example: SumOf Three Integers

Let's create a procedure named **SumOf** that calculates the sum of three 32-bit integers. We will assume that relevant integers are assigned to EAX, EBX, and ECX before the procedure is called. The procedure returns the sum in EAX:

```
SumOf PROC
    add  eax,ebx
    add  eax,ecx
    ret
SumOf ENDP
```

### Documenting Procedures

A good habit to cultivate is that of adding clear and readable documentation to your programs. The following are a few suggestions for information that you can put at the beginning of each procedure:

- A description of all tasks accomplished by the procedure.
- A list of input parameters and their usage, labeled by a word such as **Receives**. If any input parameters have specific requirements for their input values, list them here.
- A description of any values returned by the procedure, labeled by a word such as **Returns**.
- A list of any special requirements, called *preconditions*, that must be satisfied before the procedure is called. These can be labeled by the word **Requires**. For example, for a procedure that draws a graphics line, a useful precondition would be that the video display adapter must already be in graphics mode.

The descriptive labels we've chosen, such as **Receives**, **Returns**, and **Requires**, are not absolutes; other useful names are often used.

With these ideas in mind, let's add appropriate documentation to the **SumOf** procedure:

```

;-----
; sumof
;
; Calculates and returns the sum of three 32-bit integers.
; Receives: EAX, EBX, ECX, the three integers. May be
;           signed or unsigned.
; Returns:  EAX = sum
;-----
SumOf PROC
    add    eax,ebx
    add    eax,ecx
    ret
SumOf ENDP

```

Functions written in high-level languages like C and C++ typically return 8-bit values in AL, 16-bit values in AX, and 32-bit values in EAX.

### 5.2.2 CALL and RET Instructions

The CALL instruction calls a procedure by directing the processor to begin execution at a new memory location. The procedure uses a RET (return from procedure) instruction to bring the processor back to the point in the program where the procedure was called. Mechanically speaking, the CALL instruction pushes its return address on the stack and copies the called procedure's address into the instruction pointer. When the procedure is ready to return, its RET instruction pops the return address from the stack into the instruction pointer. In 32-bit mode, the CPU executes the instruction in memory pointed to by EIP (instruction pointer register). In 16-bit mode, IP points to the instruction.

#### **Call and Return Example**

Suppose that in **main**, a CALL statement is located at offset 00000020. Typically, this instruction requires 5 bytes of machine code, so the next statement (a MOV in this case) is located at offset 00000025:

```

                main PROC
00000020        call MySub
00000025        mov  eax,ebx

```

Next, suppose that the first executable instruction in **MySub** is located at offset 00000040:

```

                MySub PROC
00000040        mov  eax,edx
                .
                .
                ret
                MySub ENDP

```

When the CALL instruction executes (Fig. 5-6), the address following the call (00000025) is pushed on the stack and the address of **MySub** is loaded into EIP. All instructions in **MySub** execute up to its RET instruction. When the RET instruction executes, the value in the stack

pointed to by ESP is popped into EIP (step 1 in Fig. 5-7). In step 2, ESP is incremented so it points to the previous value on the stack (step 2).

FIGURE 5-6 Executing a CALL instruction.

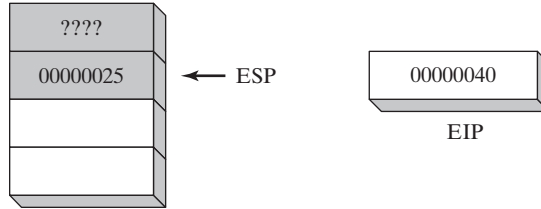
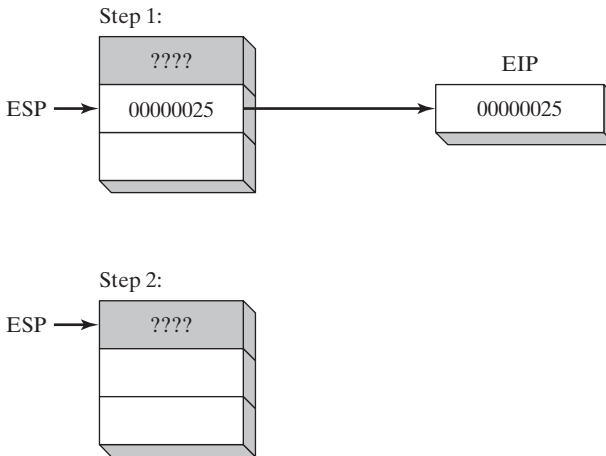


FIGURE 5-7 Executing the RET instruction.



### 5.2.3 Nested Procedure Calls

A *nested procedure call* occurs when a called procedure calls another procedure before the first procedure returns. Suppose that **main** calls a procedure named **Sub1**. While **Sub1** is executing, it calls the **Sub2** procedure. While **Sub2** is executing, it calls the **Sub3** procedure. The process is shown in Fig. 5-8.

When the RET instruction at the end of **Sub3** executes, it pops the value at stack[ESP] into the instruction pointer. This causes execution to resume at the instruction following the call **Sub3** instruction. The following diagram shows the stack just before the return from **Sub3** is executed:

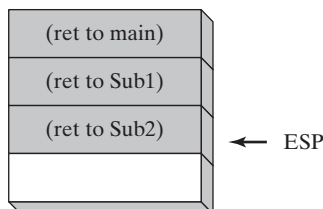
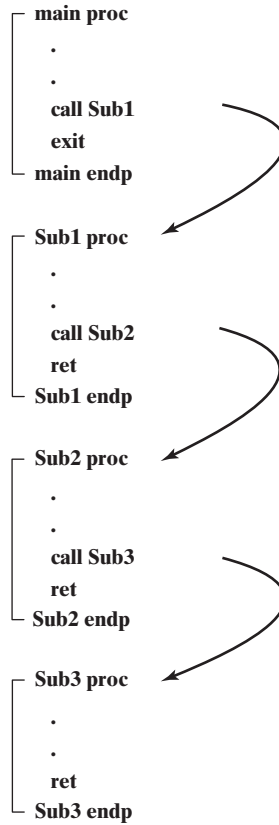
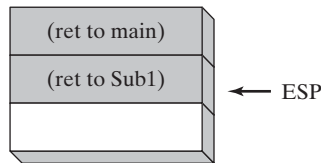


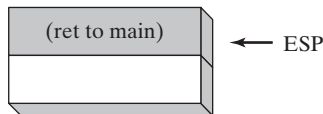
FIGURE 5-8 Nested procedure calls.



After the return, ESP points to the next-highest stack entry. When the RET instruction at the end of **Sub2** is about to execute, the stack appears as follows:



Finally, when **Sub1** returns, stack[ESP] is popped into the instruction pointer, and execution resumes in **main**:



Clearly, the stack proves itself a useful device for remembering information, including nested procedure calls. Stack structures, in general, are used in situations where programs must retrace their steps in a specific order.



### 5.2.4 Passing Register Arguments to Procedures

If you write a procedure that performs some standard operation such as calculating the sum of an integer array, it's not a good idea to include references to specific variable names inside the procedure. If you did, the procedure could only be used with one array. A better approach is to pass the offset of an array to the procedure and pass an integer specifying the number of array elements. We call these *arguments* (or *input parameters*). In assembly language, it is common to pass arguments inside general-purpose registers.

In the preceding section we created a simple procedure named **SumOf** that added the integers in the EAX, EBX, and ECX registers. In **main**, before calling **SumOf**, we assign values to EAX, EBX, and ECX:

```
.data
theSum  DWORD  ?
.code
main PROC
    mov  eax,10000h           ; argument
    mov  ebx,20000h           ; argument
    mov  ecx,30000h           ; argument
    call Sumof                ; EAX = (EAX + EBX + ECX)
    mov  theSum,eax           ; save the sum
```

After the CALL statement, we have the option of copying the sum in EAX to a variable.

### 5.2.5 Example: Summing an Integer Array

A very common type of loop that you may have already coded in C++ or Java is one that calculates the sum of an integer array. This is very easy to implement in assembly language, and it can be coded in such a way that it will run as fast as possible. For example, one can use registers rather than variables inside a loop.

Let's create a procedure named **ArraySum** that receives two parameters from a calling program: a pointer to an array of 32-bit integers, and a count of the number of array values. It calculates and returns the sum of the array in EAX:

```
;-----
; ArraySum
;
; Calculates the sum of an array of 32-bit integers.
; Receives: ESI = the array offset
;           ECX = number of elements in the array
; Returns:  EAX = sum of the array elements
;-----
ArraySum PROC
    push esi                ; save ESI, ECX
    push ecx
    mov  eax,0              ; set the sum to zero
L1:  add  eax,[esi]          ; add each integer to sum
    add  esi,TYPE DWORD     ; point to next integer
```

```

        loop L1                ; repeat for array size
        pop  ecx                ; restore ECX, ESI
        pop  esi
        ret                    ; sum is in EAX
ArraySum ENDP

```

Nothing in this procedure is specific to a certain array name or array size. It could be used in any program that needs to sum an array of 32-bit integers. Whenever possible, you should also create procedures that are flexible and adaptable.

### Testing the ArraySum Procedure

The following program tests the ArraySum procedure by calling it and passing the offset and length of an array of 32-bit integers. After calling ArraySum, it saves the procedure's return value in a variable named theSum.

```

; Testing the ArraySum procedure (TestArraySum.asm)
.386
.model flat, stdcall
.stack 4096
ExitProcess PROTO, dwExitCode:DWORD

.data
array DWORD 10000h,20000h,30000h,40000h,50000h
theSum DWORD ?

.code
main PROC
    mov  esi,OFFSET array    ; ESI points to array
    mov  ecx,LENGTHOF array ; ECX = array count
    call ArraySum           ; calculate the sum
    mov  theSum,eax         ; returned in EAX

    INVOKE ExitProcess,0
main ENDP

;-----
; ArraySum
; Calculates the sum of an array of 32-bit integers.
; Receives: ESI = the array offset
; ECX = number of elements in the array
; Returns: EAX = sum of the array elements
;-----

ArraySum PROC
    push esi                ; save ESI, ECX
    push ecx
    mov  eax,0              ; set the sum to zero

L1:
    add  eax,[esi]          ; add each integer to sum
    add  esi,TYPE DWORD     ; point to next integer
    loop L1                ; repeat for array size

```

```

        pop    ecx                ; restore ECX, ESI
        pop    esi
        ret                      ; sum is in EAX
ArraySum ENDP

END main

```

### 5.2.6 Saving and Restoring Registers

In the `ArraySum` example, `ECX` and `ESI` were pushed on the stack at the beginning of the procedure and popped at the end. This action is typical of most procedures that modify registers. Always save and restore registers that are modified by a procedure so the calling program can be sure that none of its own register values will be overwritten. The exception to this rule pertains to registers used as return values, usually `EAX`. Do not push and pop them.

#### *USES Operator*

The `USES` operator, coupled with the `PROC` directive, lets you list the names of all registers modified within a procedure. `USES` tells the assembler to do two things: First, generate `PUSH` instructions that save the registers on the stack at the beginning of the procedure. Second, generate `POP` instructions that restore the register values at the end of the procedure. The `USES` operator immediately follows `PROC`, and is itself followed by a list of registers on the same line separated by spaces or tabs (not commas).

The `ArraySum` procedure from Section 5.2.5 used `PUSH` and `POP` instructions to save and restore `ESI` and `ECX`. The `USES` operator can more easily do the same:

```

ArraySum PROC USES esi ecx
        mov    eax,0                ; set the sum to zero
L1:
        add    eax,[esi]            ; add each integer to sum
        add    esi,TYPE DWORD       ; point to next integer
        loop  L1                    ; repeat for array size

        ret                      ; sum is in EAX
ArraySum ENDP

```

The corresponding code generated by the assembler shows the effect of `USES`:

```

ArraySum PROC
        push esi
        push ecx
        mov    eax,0                ; set the sum to zero

L1:
        add    eax,[esi]            ; add each integer to sum
        add    esi,TYPE DWORD       ; point to next integer
        loop  L1                    ; repeat for array size

        pop  ecx
        pop  esi
        ret

ArraySum ENDP

```

*Debugging Tip:* When using the Microsoft Visual Studio debugger, you can view the hidden machine instructions generated by MASM's advanced operators and directives. Right-click in the Debugging window and select *Go to Disassembly*. This window displays your program's source code along with hidden machine instructions generated by the assembler.

**Exception** There is an important exception to our standing rule about saving registers that applies when a procedure returns a value in a register (usually EAX). In this case, the return register should not be pushed and popped. For example, in the SumOf procedure in the following example, it pushes and pops EAX, causing the procedure's return value to be lost:

```
SumOf PROC                                ; sum of three integers
    push  eax                               ; save EAX
    add   eax,ebx                           ; calculate the sum
    add   eax,ecx                           ; of EAX, EBX, ECX
    pop   eax                               ; lost the sum!
    ret
SumOf ENDP
```

### 5.2.7 Section Review

1. (*True/False*): The PROC directive begins a procedure and the ENDP directive ends a procedure.
2. (*True/False*): It is possible to define a procedure inside an existing procedure.
3. What would happen if the RET instruction was omitted from a procedure?
4. How are the words *Receives* and *Returns* used in the suggested procedure documentation?
5. (*True/False*): The CALL instruction pushes the offset of the CALL instruction on the stack.
6. (*True/False*): The CALL instruction pushes the offset of the instruction following the CALL on the stack.

## 5.3 Linking to an External Library

If you spend the time, you can write detailed code for input–output in assembly language. It's a lot like building your own automobile from scratch so that you can drive somewhere. The work is both interesting and time consuming. In Chapter 11 you will get a chance to see how input–output is handled in MS-Windows protected mode. It is great fun, and a new world opens up when you see the available tools. For now, however, input–output should be easy while you are learning assembly language basics. Section 5.3 shows how to call procedures from the book's link libraries, named *Irvine32.lib* and *Irvine64.obj*. The complete library source code is available at the author's web site ([asmirvine.com](http://asmirvine.com)). It should be installed on your computer in the *Examples\Lib32* subfolder of the book's install file (usually named *C:\Irvine*).

The Irvine32 library can only be used by programs running in 32-bit mode. It contains procedures that link to the MS-Windows API when they generate input–output. The Irvine64 library is a more limited library for 64-bit applications that is limited to essential display and string operations.

### 5.3.1 Background Information

A *link library* is a file containing procedures (subroutines) that have been assembled into machine code. A link library begins as one or more source files, which are assembled into object files. The object files are inserted into a specially formatted file recognized by the linker utility. Suppose a program displays a string in the console window by calling a procedure named **WriteString**. The program source must contain a **PROTO** directive identifying the **WriteString** procedure:

```
WriteString proto
```

Next, a **CALL** instruction executes **WriteString**:

```
call WriteString
```

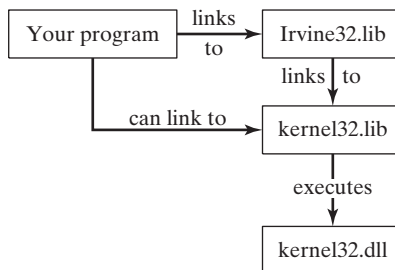
When the program is assembled, the assembler leaves the target address of the **CALL** instruction blank, knowing that it will be filled in by the linker. The linker looks for **WriteString** in the link library and copies the appropriate machine instructions from the library into the program's executable file. In addition, it inserts **WriteString's** address into the **CALL** instruction. If a procedure you're calling is not in the link library, the linker issues an error message and does not generate an executable file.

**Linker Command Options** The linker utility combines a program's object file with one or more object files and link libraries. The following command, for example, links `hello.obj` to the `irvine32.lib` and `kernel32.lib` libraries:

```
link hello.obj irvine32.lib kernel32.lib
```

**Linking 32-Bit Programs** The `kernel32.lib` file, part of the Microsoft Windows Platform *Software Development Kit*, contains linking information for system functions located in a file named `kernel32.dll`. The latter is a fundamental part of MS-Windows, and is called a *dynamic link library*. It contains executable functions that perform character-based input–output. Figure 5-9 shows how `kernel32.lib` is a bridge to `kernel32.dll`.

FIGURE 5-9 Linking 32-bit programs.



In Chapters 1 through 10, our programs link either `Irvine32.lib` or `Irvine64.obj`. Chapter 11 shows how to link programs directly to `kernel32.lib`.

### 5.3.2 Section Review

1. (*True/False*): A link library consists of assembly language source code.
2. Use the `PROTO` directive to declare a procedure named **MyProc** in an external link library.
3. Write a `CALL` statement that calls a procedure named **MyProc** in an external link library.
4. What is the name of the 32-bit link library supplied with this book?
5. What type of file is **kernel32.dll**?

## 5.4 The Irvine32 Library

### 5.4.1 Motivation for Creating the Library

There is no Microsoft-sanctioned standard library for assembly language programming. When programmers first started writing assembly language for x86 processors in the early 1980s, MS-DOS was the commonly used operating system. These 16-bit programs were able to call MS-DOS functions (known as INT 21h services) to do simple input/output. Even at that time, if you wanted to display an integer on the console, you had to write a fairly complicated procedure that converted from the internal binary representation of integers to a sequence of ASCII characters that would display the integer on the screen. We called it **WriteInt**, and this is the logic, abstracted into pseudocode:

Initialization:

```
let n equal the binary value
let buffer be an array of char[size]
```

Algorithm:

```
i = size - 1                ; last position of buffer
repeat
    r = n mod 10             ; remainder
    n = n / 10              ; integer division
    digit = r OR 30h        ; conver r to ASCII digit
    buffer[i--] = digit     ; store in buffer
until n = 0

if n is negative
    buffer[i] = "-"         ; insert a negative sign

while i > 0
    print buffer[i]
    i++
```

Notice that the digits are generated in reverse order and inserted into a buffer, moving from the back to the front. Then the digits are written to the console in forward order. While this code is easy enough to implement in C/C++, it requires some advanced skills in assembly language.

Professional programmers often prefer to build their own libraries, and doing so is an excellent educational experience. In 32-bit mode running under Windows, an input–output library must make calls directly into the operating system. The learning curve is rather steep, and it presents some challenges for beginning programmers. Therefore, the *Irvine32*

library is designed to provide a simple interface for input–output for beginners. As you continue through the chapters in this book, you will acquire the knowledge and skills to create your own library. You are free to modify and reuse the library, as long as you give credit to its original author. Another alternative, which we will discuss in Chapter 13, is to call Standard C library functions from your assembly language programs. Again, that requires some additional background.

Table 5-1 contains a complete list of procedures in the Irvine32 library.

Table 5-1 Procedures in the Irvine32 Library.

Procedure	Description
CloseFile	Closes a disk file that was previously opened.
Clsrscr	Clears the console window and locates the cursor at the upper left corner.
CreateOutputFile	Creates a new disk file for writing in output mode.
Crlf	Writes an end-of-line sequence to the console window.
Delay	Pauses the program execution for a specified <i>n</i> -millisecond interval.
DumpMem	Writes a block of memory to the console window in hexadecimal.
DumpRegs	Displays the EAX, EBX, ECX, EDX, ESI, EDI, EBP, ESP, EFLAGS, and EIP registers in hexadecimal. Also displays the most common CPU status flags.
GetCommandTail	Copies the program's command-line arguments (called the <i>command tail</i> ) into an array of bytes.
GetDateTime	Gets the current date and time from the system.
GetMaxXY	Gets the number of columns and rows in the console window's buffer.
GetMseconds	Returns the number of milliseconds elapsed since midnight.
GetTextColor	Returns the active foreground and background text colors in the console window.
Gotoxy	Locates the cursor at a specific row and column in the console window.
IsDigit	Sets the Zero flag if the AL register contains the ASCII code for a decimal digit (0–9).
MsgBox	Displays a popup message box.
MsgBoxAsk	Display a yes/no question in a popup message box.
OpenInputFile	Opens an existing disk file for input.
ParseDecimal32	Converts an unsigned decimal integer string to 32-bit binary.
ParseInteger32	Converts a signed decimal integer string to 32-bit binary.
Random32	Generates a 32-bit pseudorandom integer in the range 0 to FFFFFFFh.
Randomize	Seeds the random number generator with a unique value.
RandomRange	Generates a pseudorandom integer within a specified range.
ReadChar	Waits for a single character to be typed at the keyboard and returns the character.
ReadDec	Reads an unsigned 32-bit decimal integer from the keyboard, terminated by the Enter key.
ReadFromFile	Reads an input disk file into a buffer.
ReadHex	Reads a 32-bit hexadecimal integer from the keyboard, terminated by the Enter key.

Table 5-1 (Continued)

Procedure	Description
ReadInt	Reads a 32-bit signed decimal integer from the keyboard, terminated by the Enter key.
ReadKey	Reads a character from the keyboard's input buffer without waiting for input.
ReadString	Reads a string from the keyboard, terminated by the Enter key.
SetTextColor	Sets the foreground and background colors of all subsequent text output to the console.
Str_compare	Compares two strings.
Str_copy	Copies a source string to a destination string.
Str_length	Returns the length of a string in EAX.
Str_trim	Removes unwanted characters from a string.
Str_ucase	Converts a string to uppercase letters.
WaitMsg	Displays a message and waits for a key to be pressed.
WriteBin	Writes an unsigned 32-bit integer to the console window in ASCII binary format.
WriteBinB	Writes a binary integer to the console window in byte, word, or doubleword format.
WriteChar	Writes a single character to the console window.
WriteDec	Writes an unsigned 32-bit integer to the console window in decimal format.
WriteHex	Writes a 32-bit integer to the console window in hexadecimal format.
WriteHexB	Writes a byte, word, or doubleword integer to the console window in hexadecimal format.
WriteInt	Writes a signed 32-bit integer to the console window in decimal format.
WriteStackFrame	Writes the current procedure's stack frame to the console.
WriteStackFrameName	Writes the current procedure's name and stack frame to the console.
WriteString	Writes a null-terminated string to the console window.
WriteToFile	Writes a buffer to an output file.
WriteWindowsMsg	Displays a string containing the most recent error generated by MS-Windows.

### 5.4.2 Overview

**Console Window** The *console window* (or *command window*) is a text-only window created by MS-Windows when a command prompt is displayed.

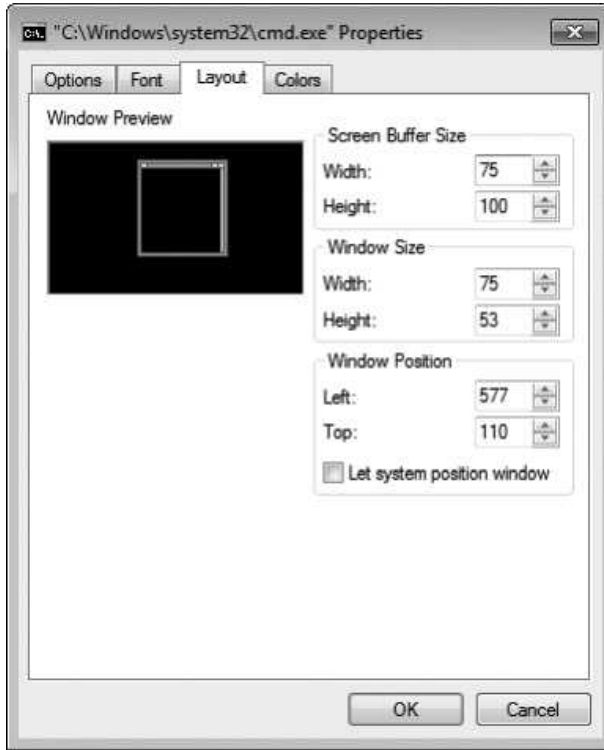
To display a console window in Microsoft Windows, click the Start button on the desktop, type *cmd* into the *Start Search* field, and press Enter. Once a console window is open, you can resize the console window buffer by right-clicking on the system menu in the window's upper-left corner, selecting *Properties* from the popup menu, and then modifying the values, as shown in Fig. 5-10.

You can also select various font sizes and colors. The console window defaults to 25 rows by 80 columns. You can use the *mode* command to change the number of columns and lines. The following, typed at the command prompt, sets the console window to 40 columns by 30 lines:

```
mode con cols=40 lines=30
```



FIGURE 5-10 Modifying the console window properties.



A *file handle* is a 32-bit integer used by the Windows operating system to identify a file that is currently open. When your program calls a Windows service to open or create a file, the operating system creates a new file handle and makes it available to your program. Each time you call an OS service method to read from or write to the file, you must pass the same file handle as a parameter to the service method.

*Note:* If your program calls procedures in the Irvine32 library, you must always push 32-bit values onto the runtime stack; if you do not, the Win32 Console functions called by the library will not work correctly.

### 5.4.3 Individual Procedure Descriptions

In this section, we describe how each of the procedures in the Irvine32 library is used. We will omit a few of the more advanced procedures, which will be explained in later chapters.

**CloseFile** The CloseFile procedure closes a file that was previously created or opened (see CreateOutputFile and OpenInputFile). The file is identified by a 32-bit integer *handle*, which is passed in EAX. If the file is closed successfully, the value returned in EAX will be nonzero. Sample call:

```
mov    eax,fileHandle
call  CloseFile
```

**Clrscr** The Clrscr procedure clears the console window. This procedure is typically called at the beginning and end of a program. If you call it at other times, you may need to pause the program by first calling WaitMsg. Doing this allows the user to view information already on the screen before it is erased. Sample call:

```
call WaitMsg           ; "Press any key..."
call Clrscr
```

**CreateOutputFile** The CreateOutputFile procedure creates a new disk file and opens it for writing. When you call the procedure, place the offset of a filename in EDX. When the procedure returns, EAX will contain a valid file handle (32-bit integer) if the file was created successfully. Otherwise, EAX equals INVALID\_HANDLE\_VALUE (a predefined constant). Sample call:

```
.data
filename BYTE "newfile.txt",0
.code
mov  edx,OFFSET filename
call CreateOutputFile
```

The following pseudocode describes the possible outcomes after calling CreateOutputFile:

```
if EAX = INVALID_HANDLE_VALUE
    the file was not created successfully
else
    EAX = handle for the open file
endif
```

**Crlf** The Crlf procedure advances the cursor to the beginning of the next line in the console window. It writes a string containing the ASCII character codes 0Dh and 0Ah. Sample call:

```
call Crlf
```

**Delay** The Delay procedure pauses the program for a specified number of milliseconds. Before calling Delay, set EAX to the desired interval. Sample call:

```
mov  eax,1000           ; 1 second
call Delay
```

**DumpMem** The DumpMem procedure writes a range of memory to the console window in hexadecimal. Pass it the starting address in ESI, the number of units in ECX, and the unit size in EBX (1 = byte, 2 = word, 4 = doubleword). The following sample call displays an array of 11 doublewords in hexadecimal:

```
.data
array DWORD 1,2,3,4,5,6,7,8,9,0Ah,0Bh
.code
main PROC
    mov  esi,OFFSET array           ; starting OFFSET
    mov  ecx,LENGTHOF array        ; number of units
    mov  ebx,TYPE array            ; doubleword format
    call DumpMem
```

The following output is produced:

```
00000001 00000002 00000003 00000004 00000005 00000006
00000007 00000008 00000009 0000000A 0000000B
```

**DumpRegs** The DumpRegs procedure displays the EAX, EBX, ECX, EDX, ESI, EDI, EBP, ESP, EIP, and EFL (EFLAGS) registers in hexadecimal. It also displays the values of the Carry, Sign, Zero, Overflow, Auxiliary Carry, and Parity flags. Sample call:

```
call DumpRegs
```

Sample output:

```
EAX=00000613 EBX=00000000 ECX=000000FF EDX=00000000
ESI=00000000 EDI=00000100 EBP=0000091E ESP=000000F6
EIP=00401026 EFL=00000286 CF=0 SF=1 ZF=0 OF=0 AF=0 PF=1
```

The displayed value of EIP is the offset of the instruction following the call to DumpRegs. DumpRegs can be useful when debugging programs because it displays a snapshot of the CPU. It has no input parameters and no return value.

**GetCommandTail** The GetCommandTail procedure copies the program's command line into a null-terminated string. If the command line was found to be empty, the Carry flag is set; otherwise, the Carry flag is cleared. This procedure is useful because it permits the user of a program to pass parameters on the command line. Suppose a program named **Encrypt.exe** reads an input file named **file1.txt** and produces an output file named **file2.txt**. The user can pass both filenames on the command line when running the program:

```
Encrypt file1.txt file2.txt
```

When it starts up, the Encrypt program can call GetCommandTail and retrieve the two filenames. When calling GetCommandTail, EDX must contain the offset of an array of at least 129 bytes. Sample call:

```
.data
cmdTail BYTE 129 DUP(0)           ; empty buffer
.code
mov  edx,OFFSET cmdTail
call GetCommandTail              ; fills the buffer
```

There is a way to pass command-line arguments when running an application in Visual Studio. From the Project menu, select *<projectname> Properties*. In the Property Pages window, expand the entry under *Configuration Properties*, and select *Debugging*. Then enter your command arguments into the edit line on the right panel named *Command Arguments*.

**GetMaxXY** The GetMaxXY procedure gets the size of the console window's buffer. If the console window buffer is larger than the visible window size, scroll bars appear automatically. GetMaxXY has no input parameters. When it returns, the DX register contains the number of buffer columns and AX contains the number of buffer rows. The possible range of each value can be no greater than 255, which may be smaller than the actual window buffer size. Sample call:

```

.data
rows BYTE ?
cols BYTE ?
.code
call GetMaxXY
mov  rows,al
mov  cols,dl

```

*GetMseconds* The *GetMseconds* procedure gets the number of milliseconds elapsed since midnight on the host computer, and returns the value in the EAX register. The procedure is a great tool for measuring the time between events. No input parameters are required. The following example calls *GetMseconds*, storing its return value. After the loop executes, the code call *GetMseconds* a second time and subtract the two time values. The difference is the approximate execution time of the loop:

```

.data
startTime DWORD ?
.code
call GetMseconds
mov  startTime,eax
L1:
    ; (loop body)
    loop L1
call GetMseconds
sub  eax,startTime           ; EAX = loop time, in milliseconds

```

*GetTextColor* The *GetTextColor* procedure gets the current foreground and background colors of the console window. It has no input parameters. It returns the background color in the upper four bits of AL and the foreground color in the lower four bits. Sample call:

```

.data
color byte ?
.code
call GetTextColor
mov  color,AL

```

*Gotoxy* The *Gotoxy* procedure locates the cursor at a given row and column in the console window. By default, the console window's X-coordinate range is 0 to 79 and the Y-coordinate range is 0 to 24. When you call *Gotoxy*, pass the Y-coordinate (row) in DH and the X-coordinate (column) in DL. Sample call:

```

mov  dh,10           ; row 10
mov  dl,20           ; column 20
call Gotoxy         ; locate cursor

```

The user may have resized the console window, so you can call *GetMaxXY* to find out the current number of rows and columns.

**IsDigit** The IsDigit procedure determines whether the value in AL is the ASCII code for a valid decimal digit. When calling it, pass an ASCII character in AL. The procedure sets the Zero flag if AL contains a valid decimal digit; otherwise, it clears Zero flag. Sample call:

```
mov  AL,somechar
call IsDigit
```

**MsgBox** The MsgBox procedure displays a graphical popup message box with an optional caption. (This works when the program is running in a console window.) Pass it the offset of a string in EDX, which will appear inside the box. Optionally, pass the offset of a string for the box's title in EBX. To leave the title blank, set EBX to zero. Sample call:

```
.data
caption BYTE "Dialog Title", 0
HelloMsg BYTE "This is a pop-up message box.", 0dh,0ah
          BYTE "Click OK to continue...", 0
.code
mov  ebx,OFFSET caption
mov  edx,OFFSET HelloMsg
call MsgBox
```

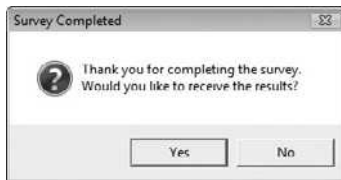
Sample output:



**MsgBoxAsk** The MsgBoxAsk procedure displays a graphical popup message box with Yes and No buttons. (This works when the program is running in a console window.) Pass it the offset of a question string in EDX, which will appear inside the box. Optionally, pass the offset of a string for the box's title in EBX. To leave the title blank, set EBX to zero. MsgBoxAsk returns an integer in EAX that tells you which button was selected by the user. The value will be one of two predefined Windows constants: IDYES (equal to 6) or IDNO (equal to 7). Sample call:

```
.data
caption BYTE "Survey Completed",0
question BYTE "Thank you for completing the survey."
          BYTE 0dh,0ah
          BYTE "Would you like to receive the results?",0
.code
mov  ebx,OFFSET caption
mov  edx,OFFSET question
call MsgBoxAsk
;(check return value in EAX)
```

Sample output:



**OpenInputFile** The `OpenInputFile` procedure opens an existing file for input. Pass it the offset of a filename in `EDX`. When it returns, if the file was opened successfully, `EAX` will contain a valid file handle. Otherwise, `EAX` will equal `INVALID_HANDLE_VALUE` (a predefined constant).

Sample call:

```
.data
filename BYTE "myfile.txt",0
.code
mov  edx,OFFSET filename
call OpenInputFile
```

The following pseudocode describes the possible outcomes after calling `OpenInputFile`:

```
if EAX = INVALID_HANDLE_VALUE
    the file was not opened successfully
else
    EAX = handle for the open file
endif
```

**ParseDecimal32** The `ParseDecimal32` procedure converts an unsigned decimal integer string to 32-bit binary. All valid digits occurring before a nonnumeric character are converted. Leading spaces are ignored. Pass it the offset of a string in `EDX` and the string's length in `ECX`. The binary value is returned in `EAX`. Sample call:

```
.data
buffer BYTE "8193"
bufSize = ($ - buffer)
.code
mov  edx,OFFSET buffer
mov  ecx,bufSize
call ParseDecimal32          ; returns EAX
```

- If the integer is blank, `EAX = 0` and `CF = 1`
- If the integer contains only spaces, `EAX = 0` and `CF = 1`
- If the integer is larger than  $2^{32}-1$ , `EAX = 0` and `CF = 1`
- Otherwise, `EAX` contains the converted integer and `CF = 0`

See the description of the **ReadDec** procedure for details about how the Carry flag is affected.

**ParseInteger32** The ParseInteger32 procedure converts a signed decimal integer string to 32-bit binary. All valid digits from the beginning of the string to the first nonnumeric character are converted. Leading spaces are ignored. Pass it the offset of a string in EDX and the string's length in ECX. The binary value is returned in EAX. Sample call:

```
.data
buffer byte "-8193"
bufSize = ($ - buffer)
.code
mov  edx,OFFSET buffer
mov  ecx,bufSize
call ParseInteger32          ; returns EAX
```

The string may contain an optional leading plus or minus sign, followed only by decimal digits. The Overflow flag is set and an error message is displayed on the console if the value cannot be represented as a 32-bit signed integer (range:  $-2,147,483,648$  to  $+2,147,483,647$ ).

**Random32** The Random32 procedure generates and returns a 32-bit random integer in EAX. When called repeatedly, Random32 generates a simulated random sequence. The numbers are created using a simple function having an input called a *seed*. The function uses the seed in a formula that generates the random value. Subsequent random values are generated using each previously generated random value as their seeds. The following code snippet shows a sample call to Random32:

```
.data
randVal DWORD ?
.code
call  Random32
mov  randVal,eax
```

**Randomize** The Randomize procedure initializes the starting seed value of the Random32 and RandomRange procedures. The seed equals the time of day, accurate to 1/100 of a second. Each time you run a program that calls Random32 and RandomRange, the generated sequence of random numbers will be unique. You need only to call Randomize once at the beginning of a program. The following example produces 10 random integers:

```
call  Randomize
mov  ecx,10
L1:  call  Random32

; use or display random value in EAX here...

loop L1
```

**RandomRange** The RandomRange procedure produces a random integer within the range of 0 to  $n - 1$ , where  $n$  is an input parameter passed in the EAX register. The random integer is returned in EAX. The following example generates a single random integer between 0 and 4999 and places it in a variable named *randVal*.

```
.data
randVal DWORD ?
```

```

.code
mov  eax,5000
call RandomRange
mov  randVal,eax

```

**ReadChar** The ReadChar procedure reads a single character from the keyboard and returns the character in the AL register. The character is not echoed in the console window. Sample call:

```

.data
char BYTE ?
.code
call ReadChar
mov  char,al

```

If the user presses an extended key such as a function key, arrow key, Ins, or Del, the procedure sets AL to zero, and AH contains a keyboard scan code. A list of scan codes is shown on the page facing the book's inside front cover. The upper half of EAX is not preserved. The following pseudocode describes the possible outcomes after calling ReadChar:

```

if an extended key was pressed
    AL = 0
    AH = keyboard scan code
else
    AL = ASCII key value
endif

```

**ReadDec** The ReadDec procedure reads a 32-bit unsigned decimal integer from the keyboard and returns the value in EAX. Leading spaces are ignored. The return value is calculated from all valid digits found until a nondigit character is encountered. For example, if the user enters 123ABC, the value returned in EAX is 123. Following is a sample call:

```

.data
intVal DWORD ?
.code
call ReadDec
mov  intVal,eax

```

ReadDec affects the Carry flag in the following ways:

- If the integer is blank, EAX = 0 and CF = 1
- If the integer contains only spaces, EAX = 0 and CF = 1
- If the integer is larger than  $2^{32}-1$ , EAX = 0 and CF = 1
- Otherwise, EAX holds the converted integer and CF = 0

**ReadFromFile** The ReadFromFile procedure reads an input disk file into a memory buffer. When you call ReadFromFile, pass it an open file handle in EAX, the offset of a buffer in EDX, and the maximum number of bytes to read in ECX. When ReadFromFile returns, check the value of the Carry flag: If CF is clear, EAX contains a count of the number of bytes read from the file. But if CF is set, EAX contains a numeric system error code. You can call the WriteWindowsMsg procedure to get a text representation of the error.



In the following example, as many as 5000 bytes are copied from the file into the buffer variable:

```
.data
BUFFER_SIZE = 5000
buffer BYTE BUFFER_SIZE DUP(?)
bytesRead DWORD ?

.code
mov  edx,OFFSET buffer      ; points to buffer
mov  ecx,BUFFER_SIZE       ; max bytes to read
call ReadFromFile          ; read the file
```

If the Carry flag were clear at this point, you could execute the following instruction:

```
mov  bytesRead,eax          ; count of bytes actually read
```

But if the Carry flag were set, you would call `WriteWindowsMsg` procedure, which displays a string that contains the error code and description of the most recent error generated by the application:

```
call WriteWindowsMsg
```

**ReadHex** The `ReadHex` procedure reads a 32-bit hexadecimal integer from the keyboard and returns the corresponding binary value in EAX. No error checking is performed for invalid characters. You can use both uppercase and lowercase letters for the digits A through F. A maximum of eight digits may be entered (additional characters are ignored). Leading spaces are ignored. Sample call:

```
.data
hexVal DWORD ?
.code
call ReadHex
mov  hexVal,eax
```

**ReadInt** The `ReadInt` procedure reads a 32-bit signed integer from the keyboard and returns the value in EAX. The user can type an optional leading plus or minus sign, and the rest of the number may only consist of digits. `ReadInt` sets the Overflow flag and display an error message if the value entered cannot be represented as a 32-bit signed integer (range:  $-2,147,483,648$  to  $+2,147,483,647$ ). The return value is calculated from all valid digits found until a nondigit character is encountered. For example, if the user enters `+123ABC`, the value returned is `+123`. Sample call:

```
.data
intVal SDWORD ?
.code
call ReadInt
mov  intVal,eax
```

**ReadKey** The `ReadKey` procedure performs a no-wait keyboard check. In other words, it inspects the keyboard input buffer to see if a key has been pressed by the user. If no keyboard data is found, the Zero flag is set. If a keypress is found by `ReadKey`, the Zero flag is cleared and AL is assigned either zero or an ASCII code. If AL contains zero, the user may have pressed a special key (function key, arrow key, etc.) The AH register contains a virtual scan code, DX

contains a virtual key code, and EBX contains the keyboard flag bits. The following pseudocode describes the various outcomes when calling `ReadKey`:

```

if no_keyboard_data then
    ZF = 1
else
    ZF = 0
    if AL = 0 then
        extended key was pressed, and AH = scan code, DX = virtual
        key code, and EBX = keyboard flag bits
    else
        AL = the key's ASCII code
    endif
endif
endif

```

The upper halves of EAX and EDX are overwritten when `ReadKey` is called.

**ReadString** The `ReadString` procedure reads a string from the keyboard, stopping when the user presses the Enter key. Pass the offset of a buffer in EDI and set ECX to the maximum number of characters the user can enter, plus 1 (to save space for the terminating null byte). The procedure returns the count of the number of characters typed by the user in EAX. Sample call:

```

.data
buffer BYTE 21 DUP(0)           ; input buffer
byteCount DWORD ?              ; holds counter
.code
mov     edx,OFFSET buffer       ; point to the buffer
mov     ecx,SIZEOF buffer       ; specify max characters
call   ReadString              ; input the string
mov     byteCount,eax          ; number of characters

```

`ReadString` automatically inserts a null terminator in memory at the end of the string. The following is a hexadecimal and ASCII dump of the first 8 bytes of `buffer` after the user has entered the string “ABCDEFGH”:

41 42 43 44 45 46 47 00	ABCDEFH
-------------------------	---------

The variable `byteCount` equals 7.

**SetTextColor** The `SetTextColor` procedure (*Irvine32 library only*) sets the foreground and background colors for text output. When calling `SetTextColor`, assign a color attribute to EAX. The following predefined color constants can be used for both foreground and background:

black = 0	red = 4	gray = 8	lightRed = 12
blue = 1	magenta = 5	lightBlue = 9	lightMagenta = 13
green = 2	brown = 6	lightGreen = 10	yellow = 14
cyan = 3	lightGray = 7	lightCyan = 11	white = 15

Color constants are defined in the *Irvine32.inc* file. To get a complete color byte value, multiply the background color by 16 and add it to the foreground color. The following constant, for example, indicates yellow characters on a blue background:

```
yellow + (blue * 16)
```

The following statements set the color to white on a blue background:

```
mov  eax,white + (blue * 16)  ; white on blue
call SetTextColor
```

An alternative way to express color constants is to use the SHL operator. You shift the background color leftward by 4 bits before adding it to the foreground color.

```
yellow + (blue SHL 4)
```

The bit shifting is performed at assembly time, so it can only have constant operands. In Chapter 7, you will learn how to shift integers at runtime. You can find a detailed explanation of video attributes in Section 16.3.2.

**Str\_length** The *Str\_length* procedure returns the length of a null-terminated string. Pass the string's offset in EDX. The procedure returns the string's length in EAX. Sample call:

```
.data
buffer BYTE "abcde",0
bufLength DWORD ?
.code
mov  edx,OFFSET buffer      ; point to string
call Str_length            ; EAX = 5
mov  bufLength,eax         ; save length
```

**WaitMsg** The *WaitMsg* procedure displays the message “Press any key to continue. . .” and waits for the user to press a key. This procedure is useful when you want to pause the screen display before data scrolls off and disappears. It has no input parameters. Sample call:

```
call WaitMsg
```

**WriteBin** The *WriteBin* procedure writes an integer to the console window in ASCII binary format. Pass the integer in EAX. The binary bits are displayed in groups of four for easy reading. Sample call:

```
mov  eax,12346AF9h
call WriteBin
```

The following output would be displayed by our sample code:

```
0001 0010 0011 0100 0110 1010 1111 1001
```

**WriteBinB** The *WriteBinB* procedure writes a 32-bit integer to the console window in ASCII binary format. Pass the value in the EAX register and let EBX indicate the display size in bytes (1, 2, or 4). The bits are displayed in groups of four for easy reading. Sample call:

```
mov  eax,00001234h
mov  ebx,TYPE WORD      ; 2 bytes
call WriteBinB          ; displays 0001 0010 0011 0100
```

**WriteChar** The WriteChar procedure writes a single character to the console window. Pass the character (or its ASCII code) in AL. Sample call:

```
mov     al, 'A'
call    WriteChar           ; displays: "A"
```

**WriteDec** The WriteDec procedure writes a 32-bit unsigned integer to the console window in decimal format with no leading zeros. Pass the integer in EAX. Sample call:

```
mov     eax, 295
call    WriteDec           ; displays: "295"
```

**WriteHex** The WriteHex procedure writes a 32-bit unsigned integer to the console window in 8-digit hexadecimal format. Leading zeros are inserted if necessary. Pass the integer in EAX. Sample call:

```
mov     eax, 7FFFh
call    WriteHex          ; displays: "00007FFF"
```

**WriteHexB** The WriteHexB procedure writes a 32-bit unsigned integer to the console window in hexadecimal format. Leading zeros are inserted if necessary. Pass the integer in EAX and EBX indicate the display format in bytes (1, 2, or 4). Sample call:

```
mov     eax, 7FFFh
mov     ebx, TYPE WORD    ; 2 bytes
call    WriteHexB        ; displays: "7FFF"
```

**WriteInt** The WriteInt procedure writes a 32-bit signed integer to the console window in decimal format with a leading sign and no leading zeros. Pass the integer in EAX. Sample call:

```
mov     eax, 216543
call    WriteInt         ; displays: "+216543"
```

**WriteString** The WriteString procedure writes a null-terminated string to the console window. Pass the string's offset in EDX. Sample call:

```
.data
prompt BYTE "Enter your name: ", 0
.code
mov     edx, OFFSET prompt
call    WriteString
```

**WriteToFile** The WriteToFile procedure writes the contents of a buffer to an output file. Pass it a valid file handle in EAX, the offset of the buffer in EDX, and the number of bytes to write in ECX. When the procedure returns, if EAX is greater than zero, it contains a count of the number of bytes written; otherwise, an error occurred. The following code calls WriteToFile:

```
BUFFER_SIZE = 5000
.data
fileHandle   DWORD ?
buffer       BYTE BUFFER_SIZE DUP(?)
```

```
.code
mov  eax,fileHandle
mov  edx,OFFSET buffer
mov  ecx,BUFFER_SIZE
call WriteToFile
```

The following pseudocode describes how to handle the value returned in EAX after calling WriteToFile:

```
if EAX = 0 then
    error occurred when writing to file
    call WriteWindowsMessage to see the error
else
    EAX = number of bytes written to the file
endif
```

**WriteWindowsMsg** The WriteWindowsMsg procedure writes a string containing the most recent error generated by your application to the Console window when executing a call to a system function. Sample call:

```
call WriteWindowsMsg
```

The following is an example of a message string:

```
Error 2: The system cannot find the file specified.
```

#### 5.4.4 Library Test Programs

##### **Tutorial: Library Test #1**

In this hands-on tutorial, you will write a program that demonstrates integer input–output with screen colors.

Step 1: Begin the program with a standard heading:

```
; Library Test #1: Integer I/O (InputLoop.asm)
; Tests the Clrscr, Crlf, DumpMem, ReadInt, SetTextColor,
; WaitMsg, WriteBin, WriteHex, and WriteString procedures.
INCLUDE Irvine32.inc
```

Step 2: Declare a **COUNT** constant that will determine the number of times the program's loop repeats later on. Then two constants, **BlueTextOnGray** and **DefaultColor**, are defined here so they can be used later on when we change the console window colors. The color byte stores the background color in the upper 4 bits, and the foreground (text) color in the lower 4 bits. We have not yet discussed bit shifting instructions, but you can multiply the background color by 16 to shift it into the high 4 bits of the color attribute byte:

```
.data
COUNT = 4
BlueTextOnGray = blue + (lightGray * 16)
DefaultColor = lightGray + (black * 16)
```

Step 3: Declare an array of signed doubleword integers, using hexadecimal constants. Also, add a string that will be used as prompt when the program asks the user to input an integer:

```
arrayD SDWORD 12345678h,1A4B2000h,3434h,7AB9h
prompt BYTE "Enter a 32-bit signed integer: ",0
```

Step 4: In the code area, declare the main procedure and write code that initializes ECX to blue text on a light gray background. The **SetTextColor** method changes the foreground and background color attributes of all text written to the window from this point onward in the program's execution:

```
.code
main PROC
    mov     eax,BlueTextOnGray
    call   SetTextColor
```

In order to set the background of the console window to the new color, you must use the `Clrscr` procedure to clear the screen:

```
call Clrscr                ; clear the screen
```

Next, the program will display a range of doubleword values in memory, identified by the variable named **arrayD**. The `DumpMem` procedure requires parameters to be passed in the ESI, EBX, and ECX registers.

Step 5: Assign to ESI the offset of **arrayD**, which marks the beginning of the range we wish to display:

```
mov     esi,OFFSET arrayD
```

Step 6: EBX is assigned an integer value that specifies the size of each array element. Since we are displaying an array of doublewords, EBX equals 4. This is the value returned by the expression `TYPE arrayD`:

```
mov     ebx,TYPE arrayD        ; doubleword = 4 bytes
```

Step 7: ECX must be set to the number of units that will be displayed, using the `LENGTHOF` operator. Then, when `DumpMem` is called, it has all the information it needs:

```
mov     ecx,LENGTHOF arrayD   ; number of units in arrayD
call   DumpMem                ; display memory
```

The following figure shows the type of output that would be generated by `DumpMem`:

```
Dump of offset 00405000
-----
12345678  1A4B2000  00003434  00007AB9
```

Next, the user will be asked to input a sequence of four signed integers. After each integer is entered, it is redisplayed in signed decimal, hexadecimal, and binary.

Step 8: Output a blank line by calling the `Crlf` procedure. Then, initialize `ECX` to the constant value `COUNT` so `ECX` can be the counter for the loop that follows:

```
call  Crlf
mov   ecx,COUNT
```

Step 9: We need to display a string that asks the user to enter an integer. Assign the offset of the string to `EDX`, and call the `WriteString` procedure. Then, call the `ReadInt` procedure to receive input from the user. The value the user enters will be automatically stored in `EAX`:

```
L1:  mov   edx,OFFSET prompt
      call WriteString
      call ReadInt           ; input integer into EAX
      call Crlf             ; display a newline
```

Step 10: Display the integer stored in `EAX` in signed decimal format by calling the `WriteInt` procedure. Then call `Crlf` to move the cursor to the next output line:

```
call  WriteInt           ; display in signed decimal
call  Crlf
```

Step 11: Display the same integer (still in `EAX`) in hexadecimal and binary formats, by calling the `WriteHex` and `WriteBin` procedures:

```
call  WriteHex          ; display in hexadecimal
call  Crlf
call  WriteBin          ; display in binary
call  Crlf
call  Crlf
```

Step 12: You will insert a `Loop` instruction that allows the loop to repeat at Label `L1`. This instruction first decrements `ECX`, and then jumps to label `L1` only if `ECX` is not equal to zero:

```
Loop  L1                ; repeat the loop
```

Step 13: After the loop ends, we want to display a “Press any key...” message and then pause the output and wait for a key to be pressed by the user. To do this, we call the `WaitMsg` procedure:

```
call  WaitMsg           ; "Press any key..."
```

Step 14: Just before the program ends, the console window attributes are returned to the default colors (light gray characters on a black background).

```
mov   eax, DefaultColor
call  SetTextColor
call  Clrscr
```

Here are the closing lines of the program:

```
exit
main ENDP
END main
```

The remainder of the program’s output is shown in the following figure, using four sample integers entered by the user:

```

Enter a 32-bit signed integer: -42
-42
FFFFFFD6
1111 1111 1111 1111 1111 1111 1101 0110

Enter a 32-bit signed integer: 36
+36
00000024
0000 0000 0000 0000 0000 0000 0010 0100

Enter a 32-bit signed integer: 244324
+244324
0003BA64
0000 0000 0000 0011 1011 1010 0110 0100

Enter a 32-bit signed integer: -7979779
-7979779
FF863CFD
1111 1111 1000 0110 0011 1100 1111 1101

```

A complete listing of the program appears below, with a few added comment lines:

```

; Library Test #1: Integer I/O   (InputLoop.asm)
; Tests the Clrscr, Crlf, DumpMem, ReadInt, SetTextColor,
; WaitMsg, WriteBin, WriteHex, and WriteString procedures.
include Irvine32.inc

.data
COUNT = 4
BlueTextOnGray = blue + (lightGray * 16)
DefaultColor = lightGray + (black * 16)
arrayD SDWORD 12345678h,1A4B2000h,3434h,7AB9h
prompt BYTE "Enter a 32-bit signed integer: ",0

.code
main PROC

; Select blue text on a light gray background
    mov     eax,BlueTextOnGray
    call   SetTextColor
    call   Clrscr                ; clear the screen

; Display an array using DumpMem.
    mov     esi,OFFSET arrayD    ; starting OFFSET
    mov     ebx,TYPE arrayD      ; doubleword = 4 bytes
    mov     ecx,LENGTHOF arrayD ; number of units in arrayD
    call   DumpMem               ; display memory

```



```

        ; Ask the user to input a sequence of signed integers
        call  Crlf                      ; new line
        mov   ecx,COUNT
L1: mov   edx,OFFSET prompt
        call  WriteString
        call  ReadInt                   ; input integer into EAX
        call  Crlf                      ; new line
; Display the integer in decimal, hexadecimal, and binary
        call  WriteInt                  ; display in signed decimal
        call  Crlf
        call  WriteHex                  ; display in hexadecimal
        call  Crlf
        call  WriteBin                  ; display in binary
        call  Crlf
        call  Crlf
        Loop  L1                        ; repeat the loop
; Return the console window to default colors
        call  WaitMsg                   ; "Press any key..."
        mov   eax,DefaultColor
        call  SetTextColor
        call  Clrscr
        exit
main ENDP
END main

```

### **Library Test #2: Random Integers**

Let's look at a second library test program that demonstrates random-number-generation capabilities of the link library, and introduces the CALL instruction (to be covered fully in Section 5.5). First, it randomly generates 10 unsigned integers in the range 0 to 4,294,967,294. Next, it generates 10 signed integers in the range -50 to +49:

```

; Link Library Test #2 (TestLib2.asm)
; Testing the Irvine32 Library procedures.
include Irvine32.inc
TAB = 9                      ; ASCII code for Tab
.code
main PROC
    call  Randomize          ; init random generator
    call  Rand1
    call  Rand2
    exit
main ENDP
Rand1 PROC
; Generate ten pseudo-random integers.
    mov   ecx,10            ; loop 10 times
L1: call  Random32          ; generate random int

```

```

        call WriteDec          ; write in unsigned decimal
        mov  al,TAB           ; horizontal tab
        call WriteChar       ; write the tab
        loop L1

        call Crlf
        ret
Rand1 ENDP

Rand2 PROC
; Generate ten pseudo-random integers from -50 to +49
        mov  ecx,10          ; loop 10 times
L1:    mov  eax,100          ; values 0-99
        call RandomRange    ; generate random int
        sub  eax,50          ; values -50 to +49
        call WriteInt       ; write signed decimal
        mov  al,TAB         ; horizontal tab
        call WriteChar     ; write the tab
        loop L1

        call Crlf
        ret
Rand2 ENDP
END main

```

Here is sample output from the program:

3221236194	2210931702	974700167	367494257	2227888607					
926772240	506254858	1769123448	2288603673	736071794					
-34	+27	+38	-34	+31	-13	-29	+44	-48	-43

### Library Test #3: Performance Timing

Assembly language is often used to optimize sections of code seen as critical to a program's performance. The *GetMseconds* procedure from the book's library returns the number of milliseconds elapsed since midnight. In our third library test program, we call *GetMseconds*, execute a nested loop, and call *GetMseconds* a second time. The difference between the two values returned by these procedure calls gives us the elapsed time of the nested loop:

```

; Link Library Test #3          (TestLib3.asm)
; Calculate the elapsed execution time of a nested loop
include Irvine32.inc

.data
OUTER_LOOP_COUNT = 3
startTime DWORD ?
msg1 byte "Please wait...",0dh,0ah,0
msg2 byte "Elapsed milliseconds: ",0

.code

```

```

main PROC
    mov     edx,OFFSET msg1      ; "Please wait..."
    call   WriteString

; Save the starting time
    call   GetMSeconds
    mov    startTime,eax

; Start the outer loop
    mov    ecx,OUTER_LOOP_COUNT

L1: call   innerLoop
    loop  L1

; Calculate the elapsed time
    call   GetMSeconds
    sub    eax,startTime

; Display the elapsed time
    mov    edx,OFFSET msg2      ; "Elapsed milliseconds: "
    call   WriteString
    call   WriteDec             ; write the milliseconds
    call   Crlf

    exit
main ENDP

innerLoop PROC
    push   ecx                  ; save current ECX value
    mov    ecx,0FFFFFFFh       ; set the loop counter
L1: mul    eax                  ; use up some cycles
    mul    eax
    mul    eax
    loop  L1                   ; repeat the inner loop
    pop    ecx                  ; restore ECX's saved value
    ret
innerLoop ENDP

END main

```

Here is sample output from the program running on an Intel Core Duo processor:

```

Please wait....
Elapsed milliseconds: 4974

```

### Detailed Analysis of the Program

Let us study Library Test #3 in greater detail. The *main* procedure displays the string “Please wait...” in the console window:

```

main PROC
    mov     edx,OFFSET msg1      ; "Please wait..."
    call   WriteString

```

When *GetMSeconds* is called, it returns the number of milliseconds that have elapsed since midnight into the EAX register. This value is saved in a variable for later use:

```
call GetMSeconds
mov  startTime, eax
```

Next, we create a loop that executes based on the value of the OUTER\_LOOP\_COUNT constant. That value is moved to ECX for use later in the LOOP instruction:

```
mov  ecx, OUTER_LOOP_COUNT
```

The loop begins with label L1, where the *innerLoop* procedure is called. This CALL instruction repeats until ECX is decremented down to zero:

```
L1: call innerLoop
    loop L1
```

The **innerLoop** procedure uses an instruction named PUSH to save ECX on the stack before setting it to a new value. (We will discuss PUSH and POP in the upcoming Section 5.4.) Then, the loop itself has a few instructions designed to use up clock cycles:

```
innerLoop PROC
    push ecx                ; save current ECX value
    mov  ecx, 0FFFFFFFh    ; set the loop counter
L1: mul  eax                ; use up some cycles
    mul  eax
    mul  eax
    loop L1                ; repeat the inner loop
```

The LOOP instruction will have decremented ECX down to zero at this point, so we pop the saved value of ECX off the stack. It will now have the same value on leaving this procedure that it had when entering. The PUSH and POP sequence is necessary because the *main* procedure was using ECX as a loop counter when it called the *innerLoop* procedure. Here are the last few lines of *innerLoop*:

```
pop  ecx                ; restore ECX's saved value
ret
innerLoop ENDP
```

Back in the *main* procedure, after the loop finishes, we call *GetMSeconds*, which returns its result in EAX. All we have to do is subtract the starting time from this value to get the number of milliseconds that elapsed between the two calls to *GetMSeconds*:

```
call GetMSeconds
sub  eax, startTime
```

The program displays a new string message, and then displays the integer in EAX that represents the number of elapsed milliseconds:

```
mov  edx, OFFSET msg2    ; "Elapsed milliseconds: "
call WriteString
call WriteDec            ; display the value in EAX
call Crlf
exit
main ENDP
```

### 5.4.5 Section Review

1. Which procedure in the link library generates a random integer within a selected range?
2. Which procedure in the link library displays “Press [Enter] to continue. . .” and waits for the user to press the Enter key?
3. Write statements that cause a program to pause for 700 milliseconds.
4. Which procedure from the link library writes an unsigned integer to the console window in decimal format?
5. Which procedure from the link library places the cursor at a specific console window location?
6. Write the `INCLUDE` directive that is required when using the `Irvine32` library.
7. What types of statements are inside the `Irvine32.inc` file?
8. What are the required input parameters for the `DumpMem` procedure?
9. What are the required input parameters for the `ReadString` procedure?
10. Which processor status flags are displayed by the `DumpRegs` procedure?
11. *Challenge*: Write statements that prompt the user for an identification number and input a string of digits into an array of bytes.

## 5.5 64-Bit Assembly Programming

### 5.5.1 The `Irvine64` Library

Our book provides a minimal library to assist you with 64-bit programming, containing the following procedures:

- **Crlf**: Writes an end-of-line sequence to the console.
- **Random64**: Generates a 64-bit pseudorandom integer in the range 0 to  $2^{64}-1$ . The random value is returned in the RAX register.
- **Randomize**: Seeds the random number generator with a unique value.
- **ReadInt64**: Reads a 64-bit signed integer from the keyboard, terminated by the Enter key. It returns the integer value in the RAX register.
- **ReadString**: Reads a string from the keyboard, terminated by the Enter key. Pass it the offset of the input buffer in RDX, and set RCX to the maximum number of characters the user can enter, plus 1 (for the null terminator byte). It returns a count (in RAX) of the number of characters typed by the user.
- **Str\_compare**: Compares two strings. Pass it a pointer to the source string in RSI, and a pointer to the target string in RDI. Sets the Zero and Carry flags in the same way as the `CMP` (Compare) instruction.
- **Str\_copy**: Copies a source string to the location indicated by a target pointer. Pass the source offset in RSI, and the target offset in RDI.
- **Str\_length**: Returns the length of a null-terminated string in the RAX register. Pass it the string's offset in RCX.
- **WriteInt64**: Displays the contents of the RAX register as a 64-bit signed decimal integer, with a leading plus or minus sign. It has no return value.

- **WriteHex64:** Displays the contents of the RAX register as a 64-bit hexadecimal integer. It has no return value.
- **WriteHexB:** Displays the contents of the RAX register as a hexadecimal integer in either a 1-byte, 2-byte, 4-byte, or 8-byte format. Pass it the display size (1, 2, 4, or 8) in the RBX register. It has no return value.
- **WriteString:** Displays a null-terminated ASCII string. Pass it the string's 64-bit offset in RDX. It has no return value.

Although this library is much smaller than our 32-bit library, it contains many of the essential tools you need for making programs more interactive. You are also encouraged to expand this library with your own code as you progress through the book. The *Irvine64* library preserves the values of the RBX, RBP, RDI, RSI, R12, R14, R14, and R15 registers. On the other hand, the RAX, RCX, RDX, R8, R9, R10, and R11 register values are usually not preserved.

### 5.5.2 Calling 64-Bit Subroutines

If you want to call a subroutine you have created, or a subroutine in the *Irvine64* library, all you have to do is place input parameters in registers and execute the `CALL` instruction. For example:

```
mov    rax,12345678h
call   WriteHex64
```

There's one other small thing you have to do, which is to use the `PROTO` directive at the top of your program to identify each procedure you plan to call that's outside your own program:

```
ExitProcess    PROTO    ; located in the Windows API
WriteHex64     PROTO    ; located in the Irvine64 library
```

### 5.5.3 The x64 Calling Convention

Microsoft follows a consistent scheme for passing parameters and calling procedures in 64-bit programs known as the *Microsoft x64 Calling Convention*. This convention is used by C/C++ compilers, as well as by the Windows Application Programming Interface (API). The only times you need to use this calling convention is when you either call a function in the Windows API, or you call a function written in C or C++. Here are some of the basic characteristics of this calling convention:

1. The `CALL` instruction subtracts 8 from the RSP (stack pointer) register, since addresses are 64-bits long.
2. The first four parameters passed to a procedure are placed in the RCX, RDX, R8, and R9, registers, in that order. If only one parameter is passed, it will be placed in RCX. If there is a second parameter, it will be placed in RDX, and so on. Additional parameters are pushed on the stack, in left-to-right order.
3. It is the caller's responsibility to allocate at least 32 bytes of *shadow space* on the runtime stack, so the called procedures can optionally save the register parameters in this area.
4. When calling a subroutine, the stack pointer (RSP) must be aligned on a 16-byte boundary (a multiple of 16). The `CALL` instruction pushes an 8-byte return address on the stack, so the calling program must subtract 8 from the stack pointer, in addition to the 32 it already subtracts for the shadow space. We will soon show how this is done in a sample program.

The remaining details about the x64 calling convention will be introduced in Chapter 8, when we discuss the runtime stack in greater detail. Here's the good news: you do not have to use the Microsoft x64 calling convention when calling subroutines in the *Irvine64* library. You only need to use it when calling Windows API functions.

### 5.5.4 Sample Program that Calls a Procedure

Let's create a short program that uses the Microsoft x64 calling convention to call a subroutine named **AddFour**. This subroutine adds the values in the four parameter registers (RCX, RDX, R8, and R9) and saves the sum in RAX. Because procedures normally return integer values in RAX, the calling program expects that value to be in this register when the subroutine returns. In this way, we can say that the subroutine is a function, because it receives four inputs and (deterministically) produces a single output.

```

1: ; Calling a subroutine in 64-bit mode      (CallProc_64.asm)
2: ; Chapter 5 example
3:
4: ExitProcess PROTO
5: WriteInt64 PROTO           ; Irvine64 library
6: Crlf PROTO                 ; Irvine64 library
7:
8: .code
9: main PROC
10:  sub  rsp,8                 ; align the stack pointer
11:  sub  rsp,20h              ; reserve 32 bytes for shadow params
12:
13:  mov  rcx,1                 ; pass four parameters, in order
14:  mov  rdx,2
15:  mov  r8,3
16:  mov  r9,4
17:  call AddFour              ; look for return value in RAX
18:  call WriteInt64          ; display the number
19:  call Crlf                ; output a CR/LF
20:
21:  mov  ecx,0
22:  call ExitProcess
23: main ENDP
24:
25: AddFour PROC
26:  mov  rax,rcx
27:  add  rax,rdx
28:  add  rax,r8
29:  add  rax,r9               ; sum is in RAX
30:  ret
31: AddFour ENDP
32:
33: END

```

Let's examine a few other details in the example: Line 10 aligns the stack pointer to an even 16-byte boundary. Why does this work? Before the OS called main, we assume the stack pointer





## 5.6 Chapter Summary

This chapter introduces the book's link library to make it easier for you to process input–output in assembly language applications.

Table 5-1 lists most of the procedures from the Irvine32 link library. The most up-to-date listing of all procedures is available on the book's Web site ([www.asmirvine.com](http://www.asmirvine.com)).

The *library test program* in Section 5.4.4 demonstrates a number of input–output functions from the Irvine32 library. It generates and displays a list of random numbers, a register dump, and a memory dump. It displays integers in various formats and demonstrates string input–output.

The *runtime stack* is a special array that is used as a temporary holding area for addresses and data. The ESP register holds a 32-bit OFFSET into some location on the stack. The stack is called a LIFO structure (*last-in, first-out*) because the last value placed in the stack is the first value taken out. A *push operation* copies a value into the stack. A *pop operation* removes a value from the stack and copies it to a register or variable. Stacks often hold procedure return addresses, procedure parameters, local variables, and registers used internally by procedures.

The PUSH instruction first decrements the stack pointer and then copies a source operand into the stack. The POP instruction first copies the contents of the stack pointed to by ESP into a destination operand and then increments ESP.

The PUSHAD instruction pushes the 32-bit general-purpose registers on the stack, and the PUSHA instruction does the same for the 16-bit general-purpose registers. The POPAD instruction pops the stack into the 32-bit general-purpose registers, and the POPA instruction does the same for the 16-bit general-purpose registers. PUSHA and POPA should only be used for 16-bit programming.

The PUSHFD instruction pushes the 32-bit EFLAGS register on the stack, and POPFD pops the stack into EFLAGS. PUSHF and POPF do the same for the 16-bit FLAGS register.

The *RevStr* program (Section 5.1.2) uses the stack to reverse a string of characters.

A *procedure* is a named block of code declared using the PROC and ENDP directives. A procedure's execution ends with the RET instruction. The SumOf procedure, shown in Section 5.2.1, calculates the sum of three integers. The CALL instruction executes a procedure by inserting the procedure's address into the instruction pointer register. When the procedure finishes, the RET (return from procedure) instruction brings the processor back to the point in the program from where the procedure was called. A *nested procedure call* occurs when a called procedure calls another procedure before it returns.

A code label followed by a single colon is only visible within its enclosing procedure. A code label followed by :: is a global label, making it accessible from any statement in the same source code file.

The ArraySum procedure, shown in Section 5.2.5, calculates and returns the sum of the elements in an array.

The USES operator, coupled with the PROC directive, lets you list all registers modified by a procedure. The assembler generates code that pushes the registers at the beginning of the procedure and pops the registers before returning.

## 5.7 Key Terms

### 5.7.1 Terms

arguments	nested procedure call
console window	precondition
file handle	pop operation
global label	push operation
input parameter	runtime stack
label	stack abstract data type
last-in, first-out (LIFO)	stack data structure
link library	stack pointer register

### 5.7.2 Instructions, Operators, and Directives

ENDP	PUSH
POP	PUSHA
POPA	PUSHAD
POPAD	PUSHFD
POPFD	RET
PROC	USES

## 5.8 Review Questions and Exercises

### 5.8.1 Short Answer

1. Which instruction pushes all of the 32-bit general-purpose registers on the stack?
2. Which instruction pushes the 32-bit EFLAGS register on the stack?
3. Which instruction pops the stack into the EFLAGS register?
4. *Challenge:* Another assembler (called NASM) permits the PUSH instruction to list multiple specific registers. Why might this approach be better than the PUSHAD instruction in MASM? Here is a NASM example:
 

```
PUSH EAX EBX ECX
```
5. *Challenge:* Suppose there were no PUSH instruction. Write a sequence of two other instructions that would accomplish the same as push eax.
6. (*True/False*): The RET instruction pops the top of the stack into the instruction pointer.
7. (*True/False*): Nested procedure calls are not permitted by the Microsoft assembler unless the NESTED operator is used in the procedure definition.
8. (*True/False*): In protected mode, each procedure call uses a minimum of 4 bytes of stack space.
9. (*True/False*): The ESI and EDI registers cannot be used when passing 32-bit parameters to procedures.

10. (*True/False*): The ArraySum procedure (Section 5.2.5) receives a pointer to any array of doublewords.
11. (*True/False*): The USES operator lets you name all registers that are modified within a procedure.
12. (*True/False*): The USES operator only generates PUSH instructions, so you must code POP instructions yourself.
13. (*True/False*): The register list in the USES directive must use commas to separate the register names.
14. Which statement(s) in the ArraySum procedure (Section 5.2.5) would have to be modified so it could accumulate an array of 16-bit words? Create such a version of ArraySum and test it.
15. What will be the final value in EAX after these instructions execute?

```

push 5
push 6
pop  eax
pop  eax

```

16. Which statement is true about what will happen when the example code runs?

```

1: main PROC
2:     push 10
3:     push 20
4:     call Ex2Sub
5:     pop  eax
6:     INVOKE ExitProcess,0
7: main ENDP
8:
9: Ex2Sub PROC
10:    pop  eax
11:    ret
12: Ex2Sub ENDP

```

- a. EAX will equal 10 on line 6
  - b. The program will halt with a runtime error on Line 10
  - c. EAX will equal 20 on line 6
  - d. The program will halt with a runtime error on Line 11
17. Which statement is true about what will happen when the example code runs?

```

1: main PROC
2:     mov  eax,30
3:     push eax
4:     push 40
5:     call Ex3Sub
6:     INVOKE ExitProcess,0
7: main ENDP
8:
9: Ex3Sub PROC
10:    pusha
11:    mov  eax,80
12:    popa

```

```

13:     ret
14: Ex3Sub ENDP

```

- EAX will equal 40 on line 6
- The program will halt with a runtime error on Line 6
- EAX will equal 30 on line 6
- The program will halt with a runtime error on Line 13

18. Which statement is true about what will happen when the example code runs?

```

1: main PROC
2:     mov eax,40
3:     push offset Here
4:     jmp Ex4Sub
5:     Here:
6:     mov eax,30
7:     INVOKE ExitProcess,0
8: main ENDP
9:
10: Ex4Sub PROC
11:     ret
12: Ex4Sub ENDP

```

- EAX will equal 30 on line 7
- The program will halt with a runtime error on Line 4
- EAX will equal 30 on line 6
- The program will halt with a runtime error on Line 11

19. Which statement is true about what will happen when the example code runs?

```

1: main PROC
2:     mov edx,0
3:     mov eax,40
4:     push eax
5:     call Ex5Sub
6:     INVOKE ExitProcess,0
7: main ENDP
8:
9: Ex5Sub PROC
10:    pop eax
11:    pop edx
12:    push eax
13:    ret
14: Ex5Sub ENDP

```

- EDX will equal 40 on line 6
- The program will halt with a runtime error on Line 13
- EDX will equal 0 on line 6
- The program will halt with a runtime error on Line 11

20. What values will be written to the array when the following code executes?

```

.data
array DWORD 4 DUP(0)
.code

```

```

main PROC
    mov eax,10
    mov esi,0
    call proc_1
    add esi,4
    add eax,10
    mov array[esi],eax
    INVOKE ExitProcess,0
main ENDP

proc_1 PROC
    call proc_2
    add esi,4
    add eax,10
    mov array[esi],eax
    ret
proc_1 ENDP

proc_2 PROC
    call proc_3
    add esi,4
    add eax,10
    mov array[esi],eax
    ret
proc_2 ENDP

proc_3 PROC
    mov array[esi],eax
    ret
proc_3 ENDP

```

## 5.8.2 Algorithm Workbench

The following exercises can be solved using either 32-bit or 64-bit code.

1. Write a sequence of statements that use only PUSH and POP instructions to exchange the values in the EAX and EBX registers (or RAX and RBX in 64-bit mode).
2. Suppose you wanted a subroutine to return to an address that was 3 bytes higher in memory than the return address currently on the stack. Write a sequence of instructions that would be inserted just before the subroutine's RET instruction that accomplish this task.
3. Functions in high-level languages often declare local variables just below the return address on the stack. Write an instruction that you could put at the beginning of an assembly language subroutine that would reserve space for two integer doubleword variables. Then, assign the values 1000h and 2000h to the two local variables.
4. Write a sequence of statements using indexed addressing that copies an element in a doubleword array to the previous position in the same array.
5. Write a sequence of statements that display a subroutine's return address. Be sure that whatever modifications you make to the stack do not prevent the subroutine from returning to its caller.

## 5.9 Programming Exercises

When you write programs to solve the programming exercises, use multiple procedures when possible. Follow the style and naming conventions used in this book, unless instructed otherwise by your instructor. Use explanatory comments in your programs at the beginning of each procedure and next to nontrivial statements.

### ★ 1. Draw Text Colors

Write a program that displays the same string in four different colors, using a loop. Call the **SetTextColor** procedure from the book's link library. Any colors may be chosen, but you may find it easiest to change the foreground color.

### ★★ 2. Linking Array Items

Suppose you are given three data items that indicate a starting index in a list, an array of characters, and an array of link index. You are to write a program that traverses the links and locates the characters in their correct sequence. For each character you locate, copy it to a new array. Suppose you used the following sample data, and assumed the arrays use zero-based indexes:

```
start = 1
chars:  H  A  C  E  B  D  F  G
links:  0  4  5  6  2  3  7  0
```

Then the values copied (in order) to the output array would be A,B,C,D,E,F,G,H. Declare the character array as type **BYTE**, and to make the problem more interesting, declare the links array type **DWORD**.

### ★ 3. Simple Addition (1)

Write a program that clears the screen, locates the cursor near the middle of the screen, prompts the user for two integers, adds the integers, and displays their sum.

### ★★ 4. Simple Addition (2)

Use the solution program from the preceding exercise as a starting point. Let this new program repeat the same steps three times, using a loop. Clear the screen after each loop iteration.

### ★ 5. BetterRandomRange Procedure

The **RandomRange** procedure from the **Irvine32** library generates a pseudorandom integer between 0 and  $N - 1$ . Your task is to create an improved version that generates an integer between  $M$  and  $N - 1$ . Let the caller pass  $M$  in **EBX** and  $N$  in **EAX**. If we call the procedure *BetterRandomRange*, the following code is a sample test:

```
mov  ebx, -300           ; lower bound
mov  eax, 100           ; upper bound
call BetterRandomRange
```

Write a short test program that calls **BetterRandomRange** from a loop that repeats 50 times. Display each randomly generated value.

**★★ 6. Random Strings**

Create a procedure that generates a random string of length  $L$ , containing all capital letters. When calling the procedure, pass the value of  $L$  in EAX, and pass a pointer to an array of byte that will hold the random string. Write a test program that calls your procedure 20 times and displays the strings in the console window.

**★ 7. Random Screen Locations**

Write a program that displays a single character at 100 random screen locations, using a timing delay of 100 milliseconds. *Hint:* Use the GetMaxXY procedure to determine the current size of the console window.

**★★ 8. Color Matrix**

Write a program that displays a single character in all possible combinations of foreground and background colors ( $16 \times 16 = 256$ ). The colors are numbered from 0 to 15, so you can use a nested loop to generate all possible combinations.

**★★★ 9. Recursive Procedure**

*Direct recursion* is the term we use when a procedure calls itself. Of course, you never want to let a procedure keep calling itself forever, because the runtime stack would fill up. Instead, you must limit the recursion in some way. Write a program that calls a recursive procedure. Inside this procedure, add 1 to a counter so you can verify the number of times it executes. Run your program with a debugger, and at the end of the program, check the counter's value. Put a number in ECX that specifies the number of times you want to allow the recursion to continue. Using only the LOOP instruction (and no other conditional statements from later chapters), find a way for the recursive procedure to call itself a fixed number of times.

**★★★ 10. Fibonacci Generator**

Write a procedure that produces  $N$  values in the Fibonacci number series and stores them in an array of doubleword. Input parameters should be a pointer to an array of doubleword, a counter of the number of values to generate. Write a test program that calls your procedure, passing  $N = 47$ . The first value in the array will be 1, and the last value will be 2,971,215,073. Use the Visual Studio debugger to open and inspect the array contents.

**★★★ 11. Finding Multiples of K**

In a byte array of size  $N$ , write a procedure that finds all multiples of  $K$  that are less than  $N$ . Initialize the array to all zeros at the beginning of the program, and then whenever a multiple is found, set the corresponding array element to 1. Your procedure must save and restore any registers it modifies. Call your procedure twice, with  $K = 2$ , and again with  $K = 3$ . Let  $N$  equal to 50. Run your program in the debugger and verify that the array values were set correctly. *Note: This procedure can be a useful tool when finding prime integers. An efficient algorithm for finding prime numbers is known as the Sieve of Eratosthenes. You will be able to implement this algorithm when conditional statements are covered in Chapter 6.*

---

# CONDITIONAL PROCESSING

- 6.1 Conditional Branching
- 6.2 Boolean and Comparison Instructions
  - 6.2.1 The CPU Status Flags
  - 6.2.2 AND Instruction
  - 6.2.3 OR Instruction
  - 6.2.4 Bit-Mapped Sets
  - 6.2.5 XOR Instruction
  - 6.2.6 NOT Instruction
  - 6.2.7 TEST Instruction
  - 6.2.8 CMP Instruction
  - 6.2.9 Setting and Clearing Individual CPU Flags
  - 6.2.10 Boolean Instructions in 64-Bit Mode
  - 6.2.11 Section Review
- 6.3 Conditional Jumps
  - 6.3.1 Conditional Structures
  - 6.3.2 *Jcond* Instruction
  - 6.3.3 Types of Conditional Jump Instructions
  - 6.3.4 Conditional Jump Applications
  - 6.3.5 Section Review
- 6.4 Conditional Loop Instructions
  - 6.4.1 LOOPZ and LOOPE Instructions
  - 6.4.2 LOOPNZ and LOOPNE Instructions
  - 6.4.3 Section Review
- 6.5 Conditional Structures
  - 6.5.1 Block-Structured IF Statements
  - 6.5.2 Compound Expressions
  - 6.5.3 WHILE Loops
  - 6.5.4 Table-Driven Selection
  - 6.5.5 Section Review
- 6.6 Application: Finite-State Machines
  - 6.6.1 Validating an Input String
  - 6.6.2 Validating a Signed Integer
  - 6.6.3 Section Review
- 6.7 Conditional Control Flow Directives
  - 6.7.1 Creating IF Statements
  - 6.7.2 Signed and Unsigned Comparisons
  - 6.7.3 Compound Expressions
  - 6.7.4 Creating Loops with .REPEAT and .WHILE
- 6.8 Chapter Summary
- 6.9 Key Terms
  - 6.9.1 Terms
  - 6.9.2 Instructions, Operators, and Directives
- 6.10 Review Questions and Exercises
  - 6.10.1 Short Answer
  - 6.10.2 Algorithm Workbench
- 6.11 Programming Exercises
  - 6.11.1 Suggestions for Testing Your Code
  - 6.11.2 Exercise Descriptions



This chapter introduces a major item to your assembly language toolchest, giving your programs the ability to make decisions. Nearly every program needs this capability. First, we start by introducing you to the Boolean operations that are the core of all decision statements because they affect the CPU status flags. Then we show how to use conditional jump and loop instructions that interpret CPU status flags. Next, we show how to use the tools from this chapter to implement one of the most fundamental structures in theoretical computer science: the Finite-State Machine. We finish the chapter by demonstrating MASM's built-in logic structures for 32-bit programming.

## 6.1 Conditional Branching

A programming language that permits decision making lets you alter the flow of control, using a technique known as *conditional branching*. Every IF statement, switch statement, or conditional loop found in high-level languages has built-in branching logic. Assembly language, as primitive as it is, provides all the tools you need for decision-making logic. In this chapter, we will see how the translation works, from high-level conditional statements to low-level implementation code.

Programs that deal with hardware devices must be able to manipulate individual bits in numbers. Individual bits must be tested, cleared, and set. Data encryption and compression also rely on bit manipulation. We will show how to perform these operations in assembly language.

This chapter should answer some basic questions:

- How can I use the boolean operations introduced in Chapter 1 (AND, OR, NOT)?
- How do I write an IF statement in assembly language?
- How are nested-IF statements translated by compilers into machine language?
- How can I set and clear individual bits in a binary number?
- How can I perform simple binary data encryption?
- How are signed numbers differentiated from unsigned numbers in boolean expressions?

This chapter follows a *bottom-up* approach, starting with the binary foundations behind programming logic. Next, you will see how the CPU compares instruction operands, using the CMP instruction and the processor status flags. Finally, we put it all together and show how to use assembly language to implement logic structures characteristic of high-level languages.

## 6.2 Boolean and Comparison Instructions

In Chapter 1, we introduced the four basic operations of boolean algebra: AND, OR, XOR, and NOT. These operations can be carried out at the binary bit level, using assembly language instructions. These operations are also important at the boolean expression level, in IF statements, for example. First, we will look at the bitwise instructions. The techniques used here could be used to manipulate control bits for hardware devices, implement communication protocols, or encrypt data, just to name a few applications. The Intel instruction set contains the AND, OR, XOR, and NOT instructions, which directly implement boolean operations on binary bits, shown in Table 6-1. In addition, the TEST instruction is a nondestructive AND operation.

TABLE 6-1 Selected Boolean Instructions.

Operation	Description
AND	Boolean AND operation between a source operand and a destination operand.
OR	Boolean OR operation between a source operand and a destination operand.
XOR	Boolean exclusive-OR operation between a source operand and a destination operand.
NOT	Boolean NOT operation on a destination operand.
TEST	Implied boolean AND operation between a source and destination operand, setting the CPU flags appropriately.

### 6.2.1 The CPU Status Flags

Boolean instructions affect the Zero, Carry, Sign, Overflow, and Parity flags. Here's a quick review of their meanings:

- The Zero flag is set when the result of an operation equals zero.
- The Carry flag is set when an operation generates a carry out of the highest bit of the destination operand.
- The Sign flag is a copy of the high bit of the destination operand, indicating that it is negative if *set* and positive if *clear*. (Zero is assumed to be positive.)
- The Overflow flag is set when an instruction generates a result that is outside the signed range of the destination operand.
- The Parity flag is set when an instruction generates an even number of 1 bits in the low byte of the destination operand.

### 6.2.2 AND Instruction

The AND instruction performs a boolean (bitwise) AND operation between each pair of matching bits in two operands and places the result in the destination operand:

```
AND destination,source
```

The following operand combinations are permitted, although immediate operands can be no larger than 32 bits:

```
AND reg,reg
AND reg,mem
AND reg,imm
AND mem,reg
AND mem,imm
```

The operands can be 8, 16, 32, or 64 bits, and they must be the same size. For each matching bit in the two operands, the following rule applies: If both bits equal 1, the result bit is 1; otherwise, it is 0. The following truth table from Chapter 1 labels the input bits  $x$  and  $y$ . The third column shows the value of the expression  $x \wedge y$ :

$x$	$y$	$x \wedge y$
0	0	0
0	1	0
1	0	0
1	1	1

The AND instruction lets you clear 1 or more bits in an operand without affecting other bits. The technique is called bit *masking*, much as you might use masking tape when painting a house to cover areas (such as windows) that should not be painted. Suppose, for example, that a control byte is about to be copied from the AL register to a hardware device. Further, we will assume that the device resets itself when bits 0 and 3 are cleared in the control byte. Assuming that we want to reset the device without modifying any other bits in AL, we can write the following:

```
and AL,11110110b    ; clear bits 0 and 3, leave others unchanged
```

For example, suppose AL is initially set to 10101110 binary. After ANDing it with 11110110, AL equals 10100110:

```
mov al,10101110b
and al,11110110b    ; result in AL = 10100110
```

**Flags** The AND instruction always clears the Overflow and Carry flags. It modifies the Sign, Zero, and Parity flags in a way that is consistent with the value assigned to the destination operand. For example, suppose the following instruction results in a value of Zero in the EAX register. In that case, the Zero flag will be set:

```
and eax,1Fh
```

### Converting Characters to Upper case

The AND instruction provides an easy way to translate a letter from lowercase to uppercase. If we compare the ASCII codes of capital **A** and lowercase **a**, it becomes clear that only bit 5 is different:

```
0 1 1 0 0 0 0 1 = 61h ('a')
0 1 0 0 0 0 0 1 = 41h ('A')
```

The rest of the alphabetic characters have the same relationship. If we AND any character with 11011111 binary, all bits are unchanged except for bit 5, which is cleared. In the following example, all characters in an array are converted to uppercase:

```
.data
array BYTE 50 DUP(?)
.code
    mov     ecx,LENGTHOF array
    mov     esi,OFFSET array
L1: and     BYTE PTR [esi],11011111b    ; clear bit 5
    inc     esi
    loop   L1
```

### 6.2.3 OR Instruction

The OR instruction performs a boolean OR operation between each pair of matching bits in two operands and places the result in the destination operand:

```
OR    destination,source
```

The OR instruction uses the same operand combinations as the AND instruction:

```
OR reg, reg
OR reg, mem
OR reg, imm
OR mem, reg
OR mem, imm
```

The operands can be 8, 16, 32, or 64 bits, and they must be the same size. For each matching bit in the two operands, the output bit is 1 when at least one of the input bits is 1. The following truth table (from Chapter 1) describes the boolean expression  $x \vee y$ :

<b>x</b>	<b>y</b>	<b><math>x \vee y</math></b>
0	0	0
0	1	1
1	0	1
1	1	1

The OR instruction is particularly useful when you need to set 1 or more bits in an operand without affecting any other bits. Suppose, for example, that your computer is attached to a servo motor, which is activated by setting bit 2 in its control byte. Assuming that the AL register contains a control byte in which each bit contains some important information, the following code only sets the bit in position 2:

```
or AL, 00000100b ; set bit 2, leave others unchanged
```

For example, if AL is initially equal to 11100011 binary and then we OR it with 00000100, the result equals 11100111:

```
mov al, 11100011b
or al, 00000100b ; result in AL = 11100111
```

**Flags** The OR instruction always clears the Carry and Overflow flags. It modifies the Sign, Zero, and Parity flags in a way that is consistent with the value assigned to the destination operand. For example, you can OR a number with itself (or zero) to obtain certain information about its value:

```
or al, al
```

The values of the Zero and Sign flags indicate the following about the contents of AL:

<b>Zero Flag</b>	<b>Sign Flag</b>	<b>Value in AL Is . . .</b>
Clear	Clear	Greater than zero
Set	Clear	Equal to zero
Clear	Set	Less than zero

### 6.2.4 Bit-Mapped Sets

Some applications manipulate sets of items selected from a limited-sized universal set. Examples might be employees within a company, or environmental readings from a weather monitoring station. In such cases, binary bits can indicate set membership. Rather than holding pointers or references to objects in a container such as a Java `HashSet`, an application can use a *bit vector* (or bit map) to map the bits in a binary number to an array of objects.

For example, the following binary number uses bit positions numbered from 0 on the right to 31 on the left to indicate that array elements 0, 1, 2, and 31 are members of the set named **SetX**:

```
SetX = 10000000 00000000 00000000 00000111
```

(The bytes have been separated to improve readability.) We can easily check for set membership by ANDing a particular member's bit position with a 1:

```
mov  eax,SetX
and  eax,10000b           ; is element[4] a member of SetX?
```

If the AND instruction in this example clears the Zero flag, we know that element [4] is a member of SetX.

#### Set Complement

The complement of a set can be generated using the NOT instruction, which reverses all bits. Therefore, the complement of the SetX that we introduced is generated in EAX using the following instructions:

```
mov  eax,SetX
not  eax                 ; complement of SetX
```

#### Set Intersection

The AND instruction produces a bit vector that represents the intersection of two sets. The following code generates and stores the intersection of SetX and SetY in EAX:

```
mov  eax,SetX
and  eax,SetY
```

This is how the intersection of SetX and SetY is produced:

```

                10000000000000000000000000000111   (SetX)
AND             1000001010100000000011101100011   (SetY)
-----
                10000000000000000000000000000011   (intersection)
```

It is hard to imagine any faster way to generate a set intersection. A larger domain would require more bits than could be held in a single register, making it necessary to use a loop to AND all of the bits together.

#### Set Union

The OR instruction produces a bit map that represents the union of two sets. The following code generates the union of SetX and SetY in EAX:

```
mov  eax,SetX
or   eax,SetY
```

This is how the union of SetX and SetY is generated by the OR instruction:

```

                10000000000000000000000000000111      (SetX)
OR             1000001010100000000011101100011      (SetY)
-----
                1000001010100000000011101100111      (union)

```

### 6.2.5 XOR Instruction

The XOR instruction performs a boolean exclusive-OR operation between each pair of matching bits in two operands and stores the result in the destination operand:

```
XOR destination, source
```

The XOR instruction uses the same operand combinations and sizes as the AND and OR instructions. For each matching bit in the two operands, the following applies: If both bits are the same (both 0 or both 1), the result is 0; otherwise, the result is 1. The following truth table describes the boolean expression  $\mathbf{x} \oplus \mathbf{y}$ :

<b>x</b>	<b>y</b>	<b><math>x \oplus y</math></b>
0	0	0
0	1	1
1	0	1
1	1	0

A bit exclusive-ORed with 0 retains its value, and a bit exclusive-ORed with 1 is toggled (complemented). XOR reverses itself when applied twice to the same operand. The following truth table shows that when bit  $x$  is exclusive-ORed with bit  $y$  twice, it reverts to its original value:

<b>x</b>	<b>y</b>	<b><math>x \oplus y</math></b>	<b><math>(x \oplus y) \oplus y</math></b>
0	0	0	0
0	1	1	0
1	0	1	1
1	1	0	1

As you will find out in Section 6.3.4, this “reversible” property of XOR makes it an ideal tool for a simple form of symmetric encryption.

**Flags** The XOR instruction always clears the Overflow and Carry flags. XOR modifies the Sign, Zero, and Parity flags in a way that is consistent with the value assigned to the destination operand.

**Checking the Parity Flag** Parity checking is a function performed on a binary number that counts the number of 1 bits contained in the number; if the resulting count is even, we say that the data has even parity; if the count is odd, the data has odd parity. In x86 processors, the Parity

flag is set when the lowest byte of the destination operand of a bitwise or arithmetic operation has even parity. Conversely, when the operand has odd parity, the flag is cleared. An effective way to check the parity of a number without changing its value is to exclusive-OR the number with zero:

```

mov  al,10110101b           ; 5 bits = odd parity
xor  al,0                    ; Parity flag clear (odd)
mov  al,11001100b           ; 4 bits = even parity
xor  al,0                    ; Parity flag set (even)

```

Visual Studio uses PE = 1 to indicate even parity, and PE = 0 to indicate odd parity.

**16-Bit Parity** You can check the parity of a 16-bit integer by performing an exclusive-OR between the upper and lower bytes:

```

mov  ax,64C1h                ; 0110 0100 1100 0001
xor  ah,al                    ; Parity flag set (even)

```

Imagine the set bits (bits equal to 1) in each register as being members of an 8-bit set. The XOR instruction zeroes all bits belonging to the intersection of the sets. XOR also forms the union between the remaining bits. The parity of this union will be the same as the parity of the entire 16-bit integer.

What about 32-bit values? If we number the bytes from  $B_0$  through  $B_3$ , we can calculate the parity as  $B_0 \text{ XOR } B_1 \text{ XOR } B_2 \text{ XOR } B_3$ .

## 6.2.6 NOT Instruction

The NOT instruction toggles (inverts) all bits in an operand. The result is called the *one's complement*. The following operand types are permitted:

```

NOT  reg
NOT  mem

```

For example, the one's complement of F0h is 0Fh:

```

mov  al,11110000b
not  al                    ; AL = 00001111b

```

**Flags** No flags are affected by the NOT instruction.

## 6.2.7 TEST Instruction

The TEST instruction performs an implied AND operation between each pair of matching bits in two operands and sets the Sign, Zero, and Parity flags based on the value assigned to the destination operand. The only difference between TEST and AND is that TEST does not modify the destination operand. The TEST instruction permits the same operand combinations as the AND instruction. TEST is particularly valuable for finding out whether individual bits in an operand are set.

*Example: Testing Multiple Bits* The TEST instruction can check several bits at once. Suppose we want to know whether bit 0 or bit 3 is set in the AL register. We can use the following instruction to find this out:

```
test al,00001001b;           test bits 0 and 3
```

(The value 00001001 in this example is called a *bit mask*.) From the following example data sets, we can infer that the Zero flag is set only when all tested bits are clear:

```
0 0 1 0 0 1 0 1 <- input value
0 0 0 0 1 0 0 1 <- test value
0 0 0 0 0 0 0 1 <- result: ZF = 0

0 0 1 0 0 1 0 0 <- input value
0 0 0 0 1 0 0 1 <- test value
0 0 0 0 0 0 0 0 <- result: ZF = 1
```

*Flags* The TEST instruction always clears the Overflow and Carry flags. It modifies the Sign, Zero, and Parity flags in the same way as the AND instruction.

### 6.2.8 CMP Instruction

Having examined all of the bitwise instructions, let's now turn to instructions used in logical (boolean) expressions. The most common boolean expressions involve some type of comparison. The following pseudocode snippets support this idea:

```
if A > B ...
while X > 0 and X < 200 ...
if check_for_error( N ) = true
```

In x86 assembly language we use the CMP instruction to compare integers. Character codes are also integers, so they work with CMP as well. Floating-point values require specialized comparison instructions, which we cover in Chapter 12.

The CMP (compare) instruction performs an implied subtraction of a source operand from a destination operand. Neither operand is modified:

```
CMP destination,source
```

CMP uses the same operand combinations as the AND instruction.

*Flags* The CMP instruction changes the Overflow, Sign, Zero, Carry, Auxiliary Carry, and Parity flags according to the value the destination operand would have had if actual subtraction had taken place. When two unsigned operands are compared, the Zero and Carry flags indicate the following relations between operands:

CMP Results	ZF	CF
Destination < source	0	1
Destination > source	0	0
Destination = source	1	0



When two signed operands are compared, the Sign, Zero, and Overflow flags indicate the following relations between operands:

CMP Results	Flags
Destination < source	SF ≠ OF
Destination > source	SF = OF
Destination = source	ZF = 1

CMP is a valuable tool for creating conditional logic structures. When you follow CMP with a conditional jump instruction, the result is the assembly language equivalent of an IF statement.

*Examples* Let's look at three code fragments showing how flags are affected by the CMP instruction. When AX equals 5 and is compared to 10, the Carry flag is set because subtracting 10 from 5 requires a borrow:

```
mov ax,5
cmp ax,10                ; ZF = 0 and CF = 1
```

Comparing 1000 to 1000 sets the Zero flag because subtracting the source from the destination produces zero:

```
mov ax,1000
mov cx,1000
cmp cx,ax                ; ZF = 1 and CF = 0
```

Comparing 105 to 0 clears both the Zero and Carry flags because subtracting 0 from 105 generates a positive, nonzero value.

```
mov si,105
cmp si,0                 ; ZF = 0 and CF = 0
```

## 6.2.9 Setting and Clearing Individual CPU Flags

How can you easily set or clear the Zero, Sign, Carry, and Overflow flags? There are several ways, some of which require modifying the destination operand. To set the Zero flag, TEST or AND an operand with Zero; to clear the Zero flag, OR an operand with 1:

```
test al,0                ; set Zero flag
and al,0                 ; set Zero flag
or al,1                  ; clear Zero flag
```

TEST does not modify the operand, whereas AND does. To set the Sign flag, OR the highest bit of an operand with 1. To clear the Sign flag, AND the highest bit with 0:

```
or al,80h                ; set Sign flag
and al,7Fh               ; clear Sign flag
```

To set the Carry flag, use the STC instruction; to clear the Carry flag, use CLC:

```
stc                      ; set Carry flag
clc                      ; clear Carry flag
```

To set the Overflow flag, add two positive values that produce a negative sum. To clear the Overflow flag, OR an operand with 0:

```

mov  al,7Fh                ; AL = +127
inc  al                    ; AL = 80h (-128), OF=1
or   eax,0                 ; clear Overflow flag

```

### 6.2.10 Boolean Instructions in 64-Bit Mode

For the most part, 64-bit instructions work exactly the same in 64-Bit mode as they do in 32-bit mode. For example, if the source operand is a constant whose size is less than 32 bits and the destination is a 64-bit register or memory operand, all bits in the destination operand are affected:

```

.data
allones QWORD 0FFFFFFFFFFFFFFFFh
.code
mov  rax,allones          ; RAX = FFFFFFFFFFFFFFFFFF
and  rax,80h              ; RAX = 0000000000000080
mov  rax,allones          ; RAX = FFFFFFFFFFFFFFFFFF
and  rax,8080h            ; RAX = 0000000000008080
mov  rax,allones          ; RAX = FFFFFFFFFFFFFFFFFF
and  rax,808080h         ; RAX = 0000000000808080

```

But when the source operand is a 32-bit constant or register, only the lower 32 bits of the destination operand are affected. In the following example, only the lower 32 bits of RAX are modified:

```

mov  rax,allones          ; RAX = FFFFFFFFFFFFFFFFFF
and  rax,80808080h        ; RAX = FFFFFFFF80808080

```

The same results are true when the destination operand is a memory operand. Clearly, 32-bit operands are a special case that you must consider separately from other operand sizes.

### 6.2.11 Section Review

1. Write a single instruction using 16-bit operands that clears the high 8 bits of AX and does not change the low 8 bits.
2. Write a single instruction using 16-bit operands that sets the high 8 bits of AX and does not change the low 8 bits.
3. Write a single instruction (other than NOT) that reverses all the bits in EAX.
4. Write instructions that set the Zero flag if the 32-bit value in EAX is even and clear the Zero flag if EAX is odd.
5. Write a single instruction that converts an uppercase character in AL to lowercase but does not modify AL if it already contains a lowercase letter.

## 6.3 Conditional Jumps

### 6.3.1 Conditional Structures

There are no explicit high-level logic structures in the x86 instruction set, but you can implement them using a combination of comparisons and jumps. Two steps are involved in executing a conditional statement: First, an operation such as CMP, AND, or SUB modifies the CPU status flags. Second, a conditional jump instruction tests the flags and causes a branch to a new address. Let's look at a couple of examples.

**Example 1** The CMP instruction in the following example compares EAX to Zero. The JZ (Jump if zero) instruction jumps to label **L1** if the Zero flag was set by the CMP instruction:

```

    cmp    eax, 0
    jz     L1                ; jump if ZF = 1
    .
    .
L1:

```

**Example 2** The AND instruction in the following example performs a bitwise AND on the DL register, affecting the Zero flag. The JNZ (jump if not Zero) instruction jumps if the Zero flag is clear:

```

    and    dl, 10110000b
    jnz    L2                ; jump if ZF = 0
    .
    .
L2:

```

### 6.3.2 Jcond Instruction

A *conditional jump instruction* branches to a destination label when a status flag condition is true. Otherwise, if the flag condition is false, the instruction immediately following the conditional jump is executed. The syntax is as follows:

*Jcond destination*

*cond* refers to a flag condition identifying the state of one or more flags. The following examples are based on the Carry and Zero flags:

JC	Jump if carry (Carry flag set)
JNC	Jump if not carry (Carry flag clear)
JZ	Jump if zero (Zero flag set)
JNZ	Jump if not zero (Zero flag clear)

CPU status flags are most commonly set by arithmetic, comparison, and boolean instructions. Conditional jump instructions evaluate the flag states, using them to determine whether or not jumps should be taken.

**Using the CMP Instruction** Suppose you want to jump to label L1 when EAX equals 5. In the next example, if EAX equals 5, the CMP instruction sets the Zero flag; then, the JE instruction jumps to L1 because the Zero flag is set:

```

    cmp    eax, 5
    je     L1                ; jump if equal

```

(The JE instruction always jumps based on the value of the Zero flag.) If EAX were not equal to 5, CMP would clear the Zero flag, and the JE instruction would not jump.

In the following example, the JL instruction jumps to label L1 because AX is less than 6:

```
mov ax,5
cmp ax,6
jl L1 ; jump if less
```

In the following example, the jump is taken because AX is greater than 4:

```
mov ax,5
cmp ax,4
jg L1 ; jump if greater
```

### 6.3.3 Types of Conditional Jump Instructions

The x86 instruction set has a large number of conditional jump instructions. They are able to compare signed and unsigned integers and perform actions based on the values of individual CPU flags. The conditional jump instructions can be divided into four groups:

- Jumps based on specific flag values
- Jumps based on equality between operands or the value of (E)CX
- Jumps based on comparisons of unsigned operands
- Jumps based on comparisons of signed operands

Table 6-2 shows a list of jumps based on the Zero, Carry, Overflow, Parity, and Sign flags.

Table 6-2 Jumps Based on Specific Flag Values.

Mnemonic	Description	Flags / Registers
JZ	Jump if zero	ZF = 1
JNZ	Jump if not zero	ZF = 0
JC	Jump if carry	CF = 1
JNC	Jump if not carry	CF = 0
JO	Jump if overflow	OF = 1
JNO	Jump if not overflow	OF = 0
JS	Jump if signed	SF = 1
JNS	Jump if not signed	SF = 0
JP	Jump if parity (even)	PF = 1
JNP	Jump if not parity (odd)	PF = 0

### Equality Comparisons

Table 6-3 lists jump instructions based on evaluating equality. In some cases, two operands are compared; in other cases, a jump is taken based on the value of CX, ECX, or RCX. In the table, the notations *leftOp* and *rightOp* refer to the left (destination) and right (source) operands in a CMP instruction:

```
CMP leftOp, rightOp
```

The operand names reflect the ordering of operands for relational operators in algebra. For example, in the expression  $X < Y$ , X is called *leftOp* and Y is called *rightOp*.

Table 6-3 Jumps Based on Equality.

Mnemonic	Description
JE	Jump if equal ( <i>leftOp = rightOp</i> )
JNE	Jump if not equal ( <i>leftOp ≠ rightOp</i> )
JCXZ	Jump if CX = 0
JECXZ	Jump if ECX = 0
JRCXZ	Jump if RCX = 0 (64-bit mode)

Although the JE instruction is equivalent to JZ (jump if Zero) and JNE is equivalent to JNZ (jump if not Zero), it's best to select the mnemonic (JE or JZ) that best indicates your intention to either compare two operands or examine a specific status flag.

Following are code examples that use the JE, JNE, JCXZ, and JECXZ instructions. Examine the comments carefully to be sure that you understand why the conditional jumps were (or were not) taken.

*Example 1:*

```

mov  edx, 0A523h
cmp  edx, 0A523h
jne  L5           ; jump not taken
je   L1           ; jump is taken

```

*Example 2:*

```

mov  bx, 1234h
sub  bx, 1234h
jne  L5           ; jump not taken
je   L1           ; jump is taken

```

*Example 3:*

```

mov  cx, 0FFFFh
inc  cx
jcxz L2           ; jump is taken

```

*Example 4:*

```

xor  ecx, ecx
jecxz L2          ; jump is taken

```

### Unsigned Comparisons

Jumps based on comparisons of unsigned numbers are shown in Table 6-4. The operand names reflect the order of operands, as in the expression (*leftOp < rightOp*). The jumps in Table 6-4 are only meaningful when comparing unsigned values. Signed operands use a different set of jumps.

### Signed Comparisons

Table 6-5 displays a list of jumps based on signed comparisons. The following instruction sequence demonstrates the comparison of two signed values:

```

mov  al, +127           ; hexadecimal value is 7Fh
cmp  al, -128          ; hexadecimal value is 80h
ja   IsAbove           ; jump not taken, because 7Fh < 80h
jg   IsGreater         ; jump taken, because +127 > -128

```

The JA instruction, which is designed for unsigned comparisons, does not jump because unsigned 7Fh is smaller than unsigned 80h. The JG instruction, on the other hand, is designed for signed comparisons—it jumps because +127 is greater than -128.

Table 6-4 Jumps Based on Unsigned Comparisons.

Mnemonic	Description
JA	Jump if above (if $leftOp > rightOp$ )
JNBE	Jump if not below or equal (same as JA)
JAE	Jump if above or equal (if $leftOp \geq rightOp$ )
JNB	Jump if not below (same as JAE)
JB	Jump if below (if $leftOp < rightOp$ )
JNAE	Jump if not above or equal (same as JB)
JBE	Jump if below or equal (if $leftOp \leq rightOp$ )
JNA	Jump if not above (same as JBE)

Table 6-5 Jumps Based on Signed Comparisons.

Mnemonic	Description
JG	Jump if greater (if $leftOp > rightOp$ )
JNLE	Jump if not less than or equal (same as JG)
JGE	Jump if greater than or equal (if $leftOp \geq rightOp$ )
JNL	Jump if not less (same as JGE)
JL	Jump if less (if $leftOp < rightOp$ )
JNGE	Jump if not greater than or equal (same as JL)
JLE	Jump if less than or equal (if $leftOp \leq rightOp$ )
JNG	Jump if not greater (same as JLE)

In the following code examples, examine the comments to be sure you understand why the jumps were (or were not) taken:

*Example 1*

```

mov    edx, -1
cmp    edx, 0
jnl   L5           ; jump not taken (-1 >= 0 is false)
jnle  L5           ; jump not taken (-1 > 0 is false)
jl    L1           ; jump is taken (-1 < 0 is true)

```

*Example 2*

```

mov    bx, +32
cmp    bx, -35
jng   L5           ; jump not taken (+32 <= -35 is false)
jnge  L5           ; jump not taken (+32 < -35 is false)
jge   L1           ; jump is taken (+32 >= -35 is true)

```

*Example 3*

```

mov ecx,0
cmp ecx,0
jg L5           ; jump not taken (0 > 0 is false)
jnl L1         ; jump is taken (0 >= 0 is true)

```

*Example 4*

```

mov ecx,0
cmp ecx,0
jl L5          ; jump not taken (0 < 0 is false)
jng L1        ; jump is taken (0 <= 0 is true)

```

**6.3.4 Conditional Jump Applications**

*Testing Status Bits* One of the things assembly language does best is bit testing. Often, we do not want to change the values of the bits we're testing, but we do want to modify the values of CPU status flags. Conditional jump instructions often use these status flags to determine whether or not to transfer control to code labels. Suppose, for example, that an 8-bit memory operand named **status** contains status information about an external device attached to the computer. The following instructions jump to a label if bit 5 is set, indicating that the device is offline:

```

mov al,status
test al,00100000b           ; test bit 5
jnz DeviceOffline

```

The following statements jump to a label if any of the bits 0, 1, or 4 are set:

```

mov al,status
test al,00010011b           ; test bits 0,1,4
jnz InputDataByte

```

Jumping to a label if bits 2, 3, and 7 are all set requires both the AND and CMP instructions:

```

mov al,status
and al,10001100b           ; mask bits 2,3,7
cmp al,10001100b           ; all bits set?
je ResetMachine             ; yes: jump to label

```

*Larger of Two Integers* The following code compares the unsigned integers in EAX and EBX and moves the larger of the two to EDX:

```

mov edx,eax                 ; assume EAX is larger
cmp eax,ebx                 ; if EAX is >= EBX
jae L1                      ; jump to L1
mov edx,ebx                 ; else move EBX to EDX
L1:                          ; EDX contains the larger integer

```

*Smallest of Three Integers* The following instructions compare the unsigned 16-bit values in the variables V1, V2, and V3 and move the smallest of the three to AX:

```

.data
V1 WORD ?
V2 WORD ?
V3 WORD ?
.code
    mov     ax,V1                ; assume V1 is smallest
    cmp     ax,V2                ; if AX <= V2
    jbe     L1                   ; jump to L1
    mov     ax,V2                ; else move V2 to AX
L1:  cmp     ax,V3                ; if AX <= V3
    jbe     L2                   ; jump to L2
    mov     ax,V3                ; else move V3 to AX
L2:

```

**Loop until Key Pressed** In the following 32-bit code, a loop runs continuously until the user presses a standard alphanumeric key. The *ReadKey* method from the Irvine32 library sets the Zero flag if no key is present in the input buffer:

```

.data
char BYTE ?
.code
L1:  mov     eax,10               ; create 10 ms delay
    call    Delay
    call    ReadKey              ; check for key
    jz      L1                   ; repeat if no key
    mov     char,AL              ; save the character

```

The foregoing code inserts a 10-millisecond delay in the loop to give MS-Windows time to process event messages. If you omit the delay, keystrokes may be ignored.

### **Application: Sequential Search of an Array**

A common programming task is to search for values in an array that meet some criteria. For example, the following program looks for the first nonzero value in an array of 16-bit integers. If it finds one, it displays the value; otherwise, it displays a message stating that a nonzero value was not found:

```

; Scanning an Array                                (ArrayScan.asm)
; Scan an array for the first nonzero value.

INCLUDE Irvine32.inc

.data
intArray  SWORD  0,0,0,0,1,20,35,-12,66,4,0
;intArray SWORD  1,0,0,0                ; alternate test data
;intArray SWORD  0,0,0,0                ; alternate test data
;intArray SWORD  0,0,0,1                ; alternate test data
noneMsg   BYTE  "A non-zero value was not found",0

```

This program contains alternate test data that are currently commented out. Uncomment each of these lines to test the program with different data configurations.



```

.code
main PROC
    mov     ebx,OFFSET intArray      ; point to the array
    mov     ecx,LENGTHOF intArray   ; loop counter

L1:  cmp     WORD PTR [ebx],0        ; compare value to zero
     jnz     found                  ; found a value
     add     ebx,2                   ; point to next
     loop   L1                      ; continue the loop
     jmp     notFound              ; none found

found:
     movsx  eax,WORD PTR[ebx]       ; sign-extend into EAX
     call   WriteInt
     jmp    quit

notFound:
     mov     edx,OFFSET noneMsg     ; display "not found" message
     call   WriteString

quit:
     call   Crlf
     exit
main ENDP
END main

```

### **Application: Simple String Encryption**

The XOR instruction has an interesting property. If an integer X is XORed with Y and the resulting value is XORed with Y again, the value produced is X:

$$((X \otimes Y) \otimes Y) = X$$

This reversible property of XOR provides an easy way to perform a simple form of data encryption: A *plain text* message is transformed into an encrypted string called *cipher text* by XORing each of its characters with a character from a third string called a *key*. The intended viewer can use the key to decrypt the cipher text and produce the original plain text.

**Example Program** We will demonstrate a simple program that uses *symmetric encryption*, a process by which the same key is used for both encryption and decryption. The following steps occur in order at runtime:

1. The user enters the plain text.
2. The program uses a single-character key to encrypt the plain text, producing the cipher text, which is displayed on the screen.
3. The program decrypts the cipher text, producing and displaying the original plain text.

Here is sample output from the program:

```

C:\WINDOWS\system32\cmd.exe
Enter the plain text: Bank account #: 8753257
Cipher text:      iÄÜä±Äi iQÜÜ¢±# ±||±r ±
Decrypted:      Bank account #: 8753257

```

*Program Listing* Here is a complete program listing:

```

; Encryption Program                                (Encrypt.asm)

INCLUDE Irvine32.inc
KEY = 239                                           ; any value between 1-255
BUFMAX = 128                                       ; maximum buffer size

.data
sPrompt BYTE "Enter the plain text:",0
sEncrypt BYTE "Cipher text: ",0
sDecrypt BYTE "Decrypted: ",0
buffer BYTE BUFMAX+1 DUP(0)
bufSize DWORD ?

.code
main PROC
    call InputTheString        ; input the plain text
    call TranslateBuffer      ; encrypt the buffer
    mov  edx,OFFSET sEncrypt  ; display encrypted message
    call DisplayMessage
    call TranslateBuffer      ; decrypt the buffer
    mov  edx,OFFSET sDecrypt  ; display decrypted message
    call DisplayMessage
    exit
main ENDP

;-----
InputTheString PROC
;
; Prompts user for a plaintext string. Saves the string
; and its length.
; Receives: nothing
; Returns: nothing
;-----
    pushad                    ; save 32-bit registers
    mov  edx,OFFSET sPrompt   ; display a prompt
    call WriteString
    mov  ecx,BUFMAX          ; maximum character count
    mov  edx,OFFSET buffer    ; point to the buffer
    call ReadString          ; input the string
    mov  bufSize,eax         ; save the length
    call Crlf
    popad
    ret
InputTheString ENDP

;-----
DisplayMessage PROC
;
; Displays the encrypted or decrypted message.
; Receives: EDX points to the message
; Returns: nothing
;-----

```

```

        pushad
        call WriteString
        mov  edx,OFFSET buffer      ; display the buffer
        call WriteString
        call Crlf
        call Crlf
        popad
        ret
DisplayMessage ENDP

;-----
TranslateBuffer PROC
;
; Translates the string by exclusive-ORing each
; byte with the encryption key byte.
; Receives: nothing
; Returns: nothing
;-----

        pushad
        mov  ecx,bufSize           ; loop counter
        mov  esi,0                 ; index 0 in buffer
L1:
        xor  buffer[esi],KEY       ; translate a byte
        inc  esi                   ; point to next byte
        loop L1
        popad
        ret
TranslateBuffer ENDP
END main

```

You should never encrypt important data with a single-character encryption key, because it can be too easily decoded. Instead, the chapter exercises suggest that you use an encryption key containing multiple characters to encrypt and decrypt the plain text.

### 6.3.5 Section Review

1. Which jump instructions follow unsigned integer comparisons?
2. Which jump instructions follow signed integer comparisons?
3. Which conditional jump instruction is equivalent to JNAE?
4. Which conditional jump instruction is equivalent to the JNA instruction?
5. Which conditional jump instruction is equivalent to the JNGE instruction?
6. (*Yes/No*): Will the following code jump to the label named **Target**?

```

mov ax,8109h
cmp ax,26h
jg Target

```

## 6.4 Conditional Loop Instructions

### 6.4.1 LOOPZ and LOOPE Instructions

The LOOPZ (loop if zero) instruction works just like the LOOP instruction except that it has one additional condition: the Zero flag must be set in order for control to transfer to the destination label. The syntax is

```
LOOPZ destination
```

The LOOPE (loop if equal) instruction is equivalent to LOOPZ, and they share the same opcode. They perform the following tasks:

```
ECX = ECX - 1
if ECX > 0 and ZF = 1, jump to destination
```

Otherwise, no jump occurs, and control passes to the next instruction. LOOPZ and LOOPE do not affect any of the status flags. In 32-bit mode, ECX is the loop counter register, and in 64-bit mode, RCX is the counter.

### 6.4.2 LOOPNZ and LOOPNE Instructions

The LOOPNZ (loop if not zero) instruction is the counterpart of LOOPZ. The loop continues while the unsigned value of ECX is greater than zero (after being decremented) and the Zero flag is clear. The syntax is

```
LOOPNZ destination
```

The LOOPNE (loop if not equal) instruction is equivalent to LOOPNZ, and they share the same opcode. They perform the following tasks:

```
ECX = ECX - 1
if ECX > 0 and ZF = 0, jump to destination
```

Otherwise, nothing happens, and control passes to the next instruction.

**Example** The following code excerpt (from *Loopnz.asm*) scans each number in an array until a nonnegative number is found (when the sign bit is clear). Notice that we push the flags on the stack before the ADD instruction because ADD will modify the flags. Then the flags are restored by POPFD just before the LOOPNZ instruction executes:

```
.data
array  SWORD  -3,-6,-1,-10,10,30,40,4
sentinel SWORD  0
.code
    mov     esi,OFFSET array
    mov     ecx,LENGTHOF array
L1:  test    WORD PTR [esi],8000h           ; test sign bit
    pushfd                               ; push flags on stack
    add     esi,TYPE array                ; move to next position
    popfd                                  ; pop flags from stack
    loopnz L1                            ; continue loop
```

```

        jnz    quit                ; none found
        sub    esi,TYPE array      ; ESI points to value
quit:

```

If a nonnegative value is found, ESI is left pointing at it. If the loop fails to find a positive number, it stops when ECX equals zero. In that case, the JNZ instruction jumps to label **quit**, and ESI points to the sentinel value (0), located in memory immediately following the array.

### 6.4.3 Section Review

1. (*True/False*): The LOOPE instruction jumps to a label when (and only when) the Zero flag is clear.
2. (*True/False*): In 32-bit mode, the LOOPNZ instruction jumps to a label when ECX is greater than zero and the Zero flag is clear.
3. (*True/False*): The destination label of a LOOPZ instruction must be no farther than  $-128$  or  $+127$  bytes from the instruction immediately following LOOPZ.
4. Modify the LOOPNZ example in Section 6.4.2 so that it scans for the first negative value in the array. Change the array initializers so they begin with positive values.
5. *Challenge*: The LOOPNZ example in Section 6.4.2 relies on a sentinel value to handle the possibility that a positive value might not be found. What might happen if you removed the sentinel?

## 6.5 Conditional Structures

We define a *conditional structure* to be one or more conditional expressions that trigger a choice between different logical branches. Each branch causes a different sequence of instructions to execute. No doubt you have already used conditional structures in a high-level programming language. But you may not know how language compilers translate conditional structures into low-level machine code. Let's find out how that is done.

### 6.5.1 Block-Structured IF Statements

An IF structure implies that a boolean expression is followed by two lists of statements; one performed when the expression is true, and another performed when the expression is false:

```

if( boolean-expression )
    statement-list-1
else
    statement-list-2

```

The **else** portion of the statement is optional. In assembly language, we code this structure in steps. First, we evaluate the boolean expression in such a way that one of the CPU status flags is affected. Second, we construct a series of jumps that transfer control to the two lists of statements, based on the value of the relevant CPU status flag.

**Example 1** In the following C++ code, two assignment statements are executed if **op1** is equal to **op2**:

```

if( op1 == op2 )
{
    X = 1;
    Y = 2;
}

```

We translate this IF statement into assembly language with a CMP instruction followed by conditional jumps. Because **op1** and **op2** are memory operands (variables), one of them must be moved to a register before executing CMP. The following code implements the IF statement as efficiently as possible by allowing the code to “fall through” to the two MOV instructions that we want to execute when the boolean condition is true:

```

mov    eax,op1
cmp    eax,op2                ; op1 == op2?
jne    L1                    ; no: skip next
mov    X,1                    ; yes: assign X and Y
mov    Y,2
L1:

```

If we implemented the == operator using JE, the resulting code would be slightly less compact (six instructions rather than five):

```

mov    eax,op1
cmp    eax,op2                ; op1 == op2?
je     L1                    ; yes: jump to L1
jmp    L2                    ; no: skip assignments
L1:   mov    X,1                ; assign X and Y
      mov    Y,2
L2:

```

As you see from the foregoing example, the same conditional structure can be translated into assembly language in multiple ways. When examples of compiled code are shown in this chapter, they represent only what a hypothetical compiler might produce.

**Example 2** In the NTFS file storage system, the size of a disk cluster depends on the disk volume’s overall capacity. In the following pseudocode, we set the cluster size to 4,096 if the volume size (in the variable named **terrabytes**) is less than 16 TBytes. Otherwise, we set the cluster size to 8,192:

```

clusterSize = 8192;
if terrabytes < 16
    clusterSize = 4096;

```

Here’s a way to implement the pseudocode in assembly language:

```

mov    clusterSize,8192      ; assume larger cluster
cmp    terrabytes, 16       ; smaller than 16 TB?
jae    next
mov    clusterSize,4096     ; switch to smaller cluster
next:

```

**Example 3** The following pseudocode statement has two branches:

```

if op1 > op2
    call Routine1
else
    call Routine2
end if

```

In the following assembly language translation of the pseudocode, we assume that **op1** and **op2** are signed doubleword variables. When comparing variables, one must be moved to a register:

```

        mov  eax,op1           ; move op1 to a register
        cmp  eax,op2           ; op1 > op2?
        jg   A1                ; yes: call Routine1
        call Routine2          ; no: call Routine2
        jmp  A2                ; exit the IF statement
A1:    call Routine1
A2:

```

### White Box Testing

Complex conditional statements may have multiple execution paths, making them hard to debug by inspection (looking at the code). Programmers often implement a technique known as *white box testing*, which verifies a subroutine's inputs and corresponding outputs. White box testing requires you to have a copy of the source code. You assign a variety of values to the input variables. For each combination of inputs, you manually trace through the source code and verify the execution path and outputs produced by the subroutine. Let's see how this is done in assembly language by implementing the following nested-IF statement:

```

if op1 == op2
    if X > Y
        call Routine1
    else
        call Routine2
    end if
else
    call Routine3
end if

```

Following is a possible translation to assembly language, with line numbers added for reference. It reverses the initial condition ( $op1 == op2$ ) and immediately jumps to the ELSE portion. All that is left to translate is the inner IF-ELSE statement:

```

1:      mov   eax,op1
2:      cmp   eax,op2           ; op1 == op2?
3:      jne   L2                ; no: call Routine3

; process the inner IF-ELSE statement.
4:      mov   eax,X
5:      cmp   eax,Y           ; X > Y?
6:      jg    L1                ; yes: call Routine1
7:      call  Routine2          ; no: call Routine2
8:      jmp   L3                ; and exit
9:  L1:  call  Routine1          ; call Routine1
10:     jmp   L3                ; and exit
11:  L2:  call  Routine3
12:  L3:

```

Table 6-6 shows the results of white box testing of the sample code. In the first four columns, test values have been assigned to op1, op2, X, and Y. The resulting execution paths are verified in columns 5 and 6.

TABLE 6-6 Testing the Nested IF Statement.

op1	op2	X	Y	Line Execution Sequence	Calls
10	20	30	40	1, 2, 3, 11, 12	Routine3
10	20	40	30	1, 2, 3, 11, 12	Routine3
10	10	30	40	1, 2, 3, 4, 5, 6, 7, 8, 12	Routine2
10	10	40	30	1, 2, 3, 4, 5, 6, 9, 10, 12	Routine1

## 6.5.2 Compound Expressions

### Logical AND Operator

Assembly language easily implements compound boolean expressions containing AND operators. Consider the following pseudocode, in which the values being compared are assumed to be unsigned integers:

```
if (a1 > b1) AND (b1 > c1)
    X = 1
end if
```

**Short-Circuit Evaluation** The following is a straightforward implementation using *short-circuit* evaluation, in which the second expression is not evaluated if the first expression is false. This is the norm for high-level languages:

```
        cmp    a1,b1                ; first expression...
        ja     L1
        jmp    next
L1:     cmp    b1,c1                ; second expression...
        ja     L2
        jmp    next
L2:     mov    X,1                  ; both true: set X to 1
next:
```

We can reduce the code to five instructions by changing the initial JA instruction to JBE:

```
        cmp    a1,b1                ; first expression...
        jbe   next                  ; quit if false
        cmp    b1,c1                ; second expression
        jbe   next                  ; quit if false
        mov    X,1                  ; both are true
next:
```

The 29% reduction in code size (seven instructions down to five) results from letting the CPU fall through to the second CMP instruction if the first JBE is not taken.



### Logical OR Operator

When a compound expression contains subexpressions joined by the OR operator, the overall expression is true if any of the subexpressions is true. Let's use the following pseudocode as an example:

```
if (a1 > b1) OR (b1 > c1)
    X = 1
```

In the following implementation, the code branches to L1 if the first expression is true; otherwise, it falls through to the second CMP instruction. The second expression reverses the > operator and uses JBE instead:

```
    cmp    al,bl                ; 1: compare AL to BL
    ja    L1                    ; if true, skip second expression
    cmp    bl,cl                ; 2: compare BL to CL
    jbe   next                  ; false: skip next statement
L1:  mov    X,1                  ; true: set X = 1
next:
```

For a given compound expression, there are multiple ways the expression can be implemented in assembly language.

### 6.5.3 WHILE Loops

A WHILE loop tests a condition first before performing a block of statements. As long as the loop condition remains true, the statements are repeated. The following loop is written in C++:

```
while( val1 < val2 )
{
    val1++;
    val2--;
}
```

When implementing this structure in assembly language, it is convenient to reverse the loop condition and jump to **endwhile** if a condition becomes true. Assuming that **val1** and **val2** are variables, we must copy one of them to a register at the beginning and restore the variable's value at the end:

```
    mov    eax,val1             ; copy variable to EAX
beginwhile:
    cmp    eax,val2             ; if not (val1 < val2)
    jnl    endwhile            ; exit the loop
    inc    eax                   ; val1++;
    dec    val2                  ; val2--;
    jmp    beginwhile           ; repeat the loop
endwhile:
    mov    val1,eax             ; save new value for val1
```

EAX is a proxy (substitute) for **val1** inside the loop. References to **val1** must be through EAX. JNL is used, implying that **val1** and **val2** are signed integers.

#### Example: IF statement Nested in a Loop

High-level languages are particularly good at representing nested control structures. In the following C++ code, an IF statement is nested inside a WHILE loop. It calculates the sum of all array elements greater than the value in **sample**:

```

int array[] = {10,60,20,33,72,89,45,65,72,18};
int sample = 50;
int ArraySize = sizeof array / sizeof sample;
int index = 0;
int sum = 0;
while( index < ArraySize )
{
    if( array[index] > sample )
    {
        sum += array[index];
    }
    index++;
}

```

Before coding this loop in assembly language, let's use the flowchart in Fig. 6-1 to describe the logic. To simplify the translation and speed up execution by reducing the number of memory accesses, registers have been substituted for variables. EDX = sample, EAX = sum, ESI = index, and ECX = ArraySize (a constant). Label names have been added to the shapes.

**Assembly Code** The easiest way to generate assembly code from a flowchart is to implement separate code for each flowchart shape. Note the direct correlation between the flowchart labels and labels used in the following source code (see *Flowchart.asm*):

```

.data
sum DWORD 0
sample DWORD 50
array DWORD 10,60,20,33,72,89,45,65,72,18
ArraySize = ($ - Array) / TYPE array

.code
main PROC
    mov     eax,0           ; sum
    mov     edx,sample
    mov     esi,0          ; index
    mov     ecx,ArraySize

L1:  cmp     esi,ecx       ; if esi < ecx
    jl     L2
    jmp    L5

L2:  cmp     array[esi*4], edx ; if array[esi] > edx
    jg     L3
    jmp    L4

L3:  add     eax,array[esi*4]

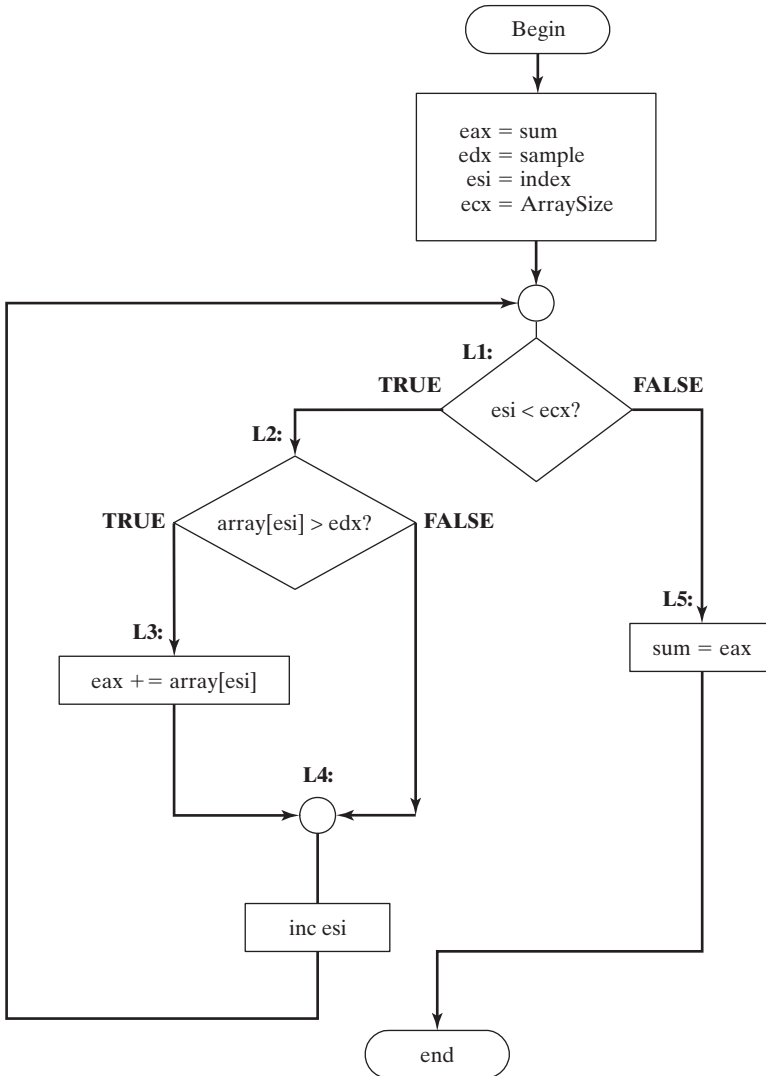
L4:  inc     esi
    jmp    L1

L5:  mov     sum,eax

```

A review question at the end of Section 6.5 will give you a chance to improve this code.

FIGURE 6-1 Loop containing IF statement.



#### 6.5.4 Table-Driven Selection

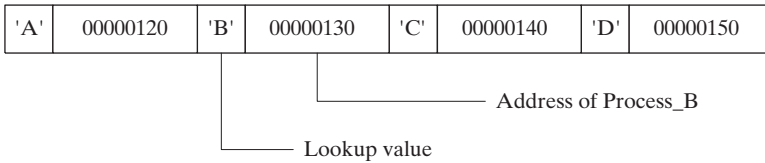
*Table-driven selection* is a way of using a table lookup to replace a multiway selection structure. To use it, you must create a table containing lookup values and the offsets of labels or procedures, and then you must use a loop to search the table. This works best when a large number of comparisons are made.

For example, the following is part of a table containing single-character lookup values and addresses of procedures:

```
.data
CaseTable BYTE 'A'           ; lookup value
          DWORD Process_A     ; address of procedure
          BYTE 'B'
          DWORD Process_B
          (etc.)
```

Let's assume `Process_A`, `Process_B`, `Process_C`, and `Process_D` are located at addresses 120h, 130h, 140h, and 150h, respectively. The table would be arranged in memory as shown in Fig. 6-2.

FIGURE 6-2 Table of procedure offsets.



**Example Program** In the following example program (*ProcTable.asm*), the user inputs a character from the keyboard. Using a loop, the character is compared to each entry in a lookup table. The first match found in the table causes a call to the procedure offset stored immediately after the lookup value. Each procedure loads `EDX` with the offset of a different string, which is displayed during the loop:

```
; Table of Procedure Offsets                (ProcTable.asm)
; This program contains a table with offsets of procedures.
; It uses the table to execute indirect procedure calls.

INCLUDE Irvine32.inc
.data
CaseTable BYTE 'A'           ; lookup value
          DWORD Process_A     ; address of procedure
EntrySize = ($ - CaseTable)
          BYTE 'B'
          DWORD Process_B
          BYTE 'C'
          DWORD Process_C
          BYTE 'D'
          DWORD Process_D

NumberOfEntries = ($ - CaseTable) / EntrySize
prompt BYTE "Press capital A,B,C,or D: ",0
```

Define a separate message string for each procedure:

```
msgA BYTE "Process_A",0
msgB BYTE "Process_B",0
msgC BYTE "Process_C",0
msgD BYTE "Process_D",0
```

```

.code
main PROC
    mov     edx,OFFSET prompt           ; ask user for input
    call   WriteString
    call   ReadChar                    ; read character into AL
    mov     ebx,OFFSET CaseTable       ; point EBX to the table
    mov     ecx,NumberOfEntries        ; loop counter

L1:
    cmp     al,[ebx]                   ; match found?
    jne     L2                          ; no: continue
    call   NEAR PTR [ebx + 1]          ; yes: call the procedure

```

This CALL instruction calls the procedure whose address is stored in the memory location referenced by EBX+1. An indirect call such as this requires the NEAR PTR operator.

```

    call   WriteString                 ; display message
    call   Crlf
    jmp    L3                          ; exit the search

L2:
    add     ebx,EntrySize               ; point to the next entry
    loop   L1                          ; repeat until ECX = 0

L3:
    exit
main ENDP

```

Each of the following procedures moves a different string offset to EDX:

```

Process_A PROC
    mov     edx,OFFSET msgA
    ret
Process_A ENDP

Process_B PROC
    mov     edx,OFFSET msgB
    ret
Process_B ENDP

Process_C PROC
    mov     edx,OFFSET msgC
    ret
Process_C ENDP

Process_D PROC
    mov     edx,OFFSET msgD
    ret
Process_D ENDP
END main

```

The table-driven selection method involves some initial overhead, but it can reduce the amount of code you write. A table can handle a large number of comparisons, and it can be more

easily modified than a long series of compare, jump, and CALL instructions. A table can even be reconfigured at runtime.

### 6.5.5 Section Review

*Notes:* In all compound expressions, use short-circuit evaluation. Assume that **val1** and **X** are 32-bit variables.

1. Implement the following pseudocode in assembly language:

```
if ebx > ecx
    X = 1
```

2. Implement the following pseudocode in assembly language:

```
if edx <= ecx
    X = 1
else
    X = 2
```

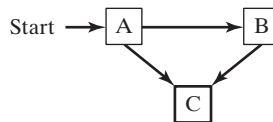
3. In the program from Section 6.5.4, why is it better to let the assembler calculate `NumberOfEntries` rather than assigning a constant such as `NumberOfEntries = 4`?
4. *Challenge:* Rewrite the code from Section 6.5.3 so it is functionally equivalent, but uses fewer instructions.

## 6.6 Application: Finite-State Machines

A *finite-state machine* (FSM) is a machine or program that changes state based on some input. It is fairly simple to use a graph to represent an FSM, which contains squares (or circles) called *nodes* and lines with arrows between the circles called *edges* (or *arcs*).

A simple example is shown in Figure 6-3. Each node represents a program state, and each edge represents a transition from one state to another. One node is designated as the *initial state*, shown in our diagram with an incoming arrow. The remaining states can be labeled with numbers or letters. One or more states are designated as *terminal states*, shown by a thick border around the square. A terminal state represents a state in which the program might stop without producing an error. A FSM is a specific instance of a more general type of structure called a *directed graph*. The latter is a set of nodes connected by edges having specific directions.

FIGURE 6-3 Simple finite-state machine.



### 6.6.1 Validating an Input String

Programs that read input streams often must validate their input by performing a certain amount of error checking. A programming language compiler, for instance, can use a FSM to scan source programs and convert words and symbols into *tokens*, which are usually keywords, arithmetic operators, and identifiers.

When using a FSM to check the validity of an input string, you usually read the input character by character. Each character is represented by an edge (transition) in the diagram. A FSM detects illegal input sequences in one of two ways:

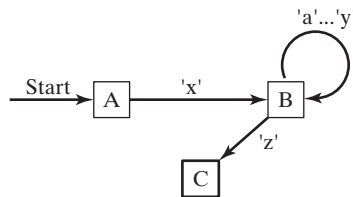
- The next input character does not correspond to any transitions from the current state.
- The end of input is reached and the current state is a nonterminal state.

**Character String Example** Let's check the validity of an input string according to the following two rules:

- The string must begin with the letter "x" and end with the letter "z."
- Between the first and last characters, there can be zero or more letters within the range {'a'...'y'}.

The FSM diagram in Fig. 6-4 describes this syntax. Each transition is identified with a particular type of input. For example, the transition from state A to state B can only be accomplished if the letter **x** is read from the input stream. A transition from state B to itself is accomplished by the input of any letter of the alphabet except **z**. A transition from state B to state C occurs only when the letter **z** is read from the input stream.

FIGURE 6-4 FSM for string.



If the end of the input stream is reached while the program is in state A or B, an error condition results because only state C is marked as a terminal state. The following input strings would be recognized by this FSM:

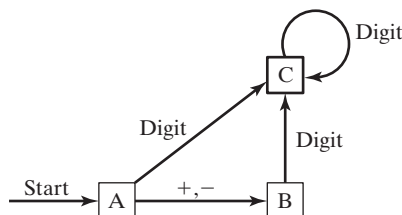
```

xaabcdefgz
xz
xyyqqrrstuvz
  
```

### 6.6.2 Validating a Signed Integer

A FSM for parsing a signed integer is shown in Fig. 6-5. Input consists of an optional leading sign followed by a sequence of digits. There is no maximum number of digits implied by the diagram.

FIGURE 6-5 Signed decimal integer FSM.



Finite-state machines are easily translated into assembly language code. Each state in the diagram (A, B, C, . . . ) is represented in the program by a label. The following actions are performed at each label:

1. A call to an input procedure reads the next character from input.
2. If the state is a terminal state, check to see whether the user has pressed the Enter key to end the input.
3. One or more compare instructions check for each possible transition leading away from the state. Each comparison is followed by a conditional jump instruction.

For example, at state A, the following code reads the next input character and checks for a possible transition to state B:

```
StateA:
    call  Getnext           ; read next char into AL
    cmp   al, '+'          ; leading + sign?
    je    StateB           ; go to State B
    cmp   al, '-'          ; leading - sign?
    je    StateB           ; go to State B
    call  IsDigit          ; ZF = 1 if AL contains a digit
    jz    StateC           ; go to State C
    call  DisplayErrorMsg  ; invalid input found
    jmp   Quit
```

Let's examine this code in more detail. First, it calls *Getnext* to read the next character from the console input into the AL register. The code will check for a leading + or – sign. It begins by comparing the value in AL to a “+” character. If the character matches, a jump is taken to the label named *StateB*:

```
StateA:
    call  Getnext           ; read next char into AL
    cmp   al, '+'          ; leading + sign?
    je    StateB           ; go to State B
```

At this point, we should look again at Fig. 6-5, and see that the transition from state A to state B can only be made if a + or – character is read from input. Therefore, the code must also check for the minus sign:

```
    cmp   al, '-'          ; leading - sign?
    je    StateB           ; go to State B
```

If a transition to state B is not possible, we can check the AL register for a digit, which would cause a transition to state C. The call to the *IsDigit* procedure (from the book's link library) sets the Zero flag if AL contains a digit:

```
    call  IsDigit          ; ZF = 1 if AL contains a digit
    jz    StateC           ; go to State C
```

Finally, there are no other possible transitions away from state A. If the character in AL has not been found to be a leading sign or digit, the program calls *DisplayErrorMsg* (which displays an error message on the console) and then jumps to the label named *Quit*:

```
    call  DisplayErrorMsg  ; invalid input found
    jmp   Quit
```



The label *Quit* marks the exit point of the program, at the end of the main procedure:

```
Quit:
    call CrLf
    exit
main ENDP
```

**Complete Finite-State Machine Program** The following program implements the signed integer FSM from Fig. 6-5:

```
; Finite State Machine                (Finite.asm)
INCLUDE Irvine32.inc
ENTER_KEY = 13
.data
InvalidInputMsg BYTE "Invalid input",13,10,0
.code
main PROC
    call Clrscr

StateA:
    call Getnext                ; read next char into AL
    cmp al,'+'                  ; leading + sign?
    je StateB                   ; go to State B
    cmp al,'-'                  ; leading - sign?
    je StateB                   ; go to State B
    call IsDigit                ; ZF = 1 if AL contains a digit
    jz StateC                   ; go to State C
    call DisplayErrorMsg        ; invalid input found
    jmp Quit

StateB:
    call Getnext                ; read next char into AL
    call IsDigit                ; ZF = 1 if AL contains a digit
    jz StateC                   ; go to State C
    call DisplayErrorMsg        ; invalid input found
    jmp Quit

StateC:
    call Getnext                ; read next char into AL
    call IsDigit                ; ZF = 1 if AL contains a digit
    jz StateC                   ; go to State C
    cmp al,ENTER_KEY           ; Enter key pressed?
    je Quit                     ; yes: quit
    call DisplayErrorMsg        ; no: invalid input found
    jmp Quit

Quit:
    call CrLf
    exit
main ENDP

;-----
```

```

Getnext PROC
;
; Reads a character from standard input.
; Receives: nothing
; Returns: AL contains the character
;-----
        call ReadChar          ; input from keyboard
        call WriteChar        ; echo on screen
        ret
Getnext ENDP
;-----
DisplayErrorMsg PROC
;
; Displays an error message indicating that
; the input stream contains illegal input.
; Receives: nothing.
; Returns: nothing
;-----
        push  edx
        mov   edx,OFFSET InvalidInputMsg
        call WriteString
        pop   edx
        ret
DisplayErrorMsg ENDP
END main

```

*IsDigit Procedure* The Finite-State Machine sample program calls the *IsDigit* procedure, which belongs to the book's link library. Let's look at the source code for *IsDigit*. It receives the AL register as input, and the value it returns is the setting of the Zero flag:

```

;-----
IsDigit PROC
;
; Determines whether the character in AL is a valid decimal digit.
; Receives: AL = character
; Returns: ZF = 1 if AL contains a valid decimal digit; otherwise, ZF = 0.
;-----
        cmp   al,'0'
        jnb  ID1          ; ZF = 0 when jump taken
        cmp   al,'9'
        ja   ID1          ; ZF = 0 when jump taken
        test  ax,0        ; set ZF = 1
ID1: ret
IsDigit ENDP

```

Before examining the code in *IsDigit*, we can review the set of hexadecimal ASCII codes for decimal digits, shown in the following table. Because the values are contiguous, we need only to check for the starting and ending range values:

Character	'0'	'1'	'2'	'3'	'4'	'5'	'6'	'7'	'8'	'9'
ASCII code (hex)	30	31	32	33	34	35	36	37	38	39

In the `IsDigit` procedure, the first two instructions compare the character in the AL register to the ASCII code for the digit 0. If the numeric ASCII code of the character is less than the ASCII code for 0, the program jumps to the label `ID1`:

```
    cmp  al, '0'
    jb  ID1                ; ZF = 0 when jump taken
```

But one may ask, if `JB` transfers control to the label named `ID1`, how do we know the state of the Zero flag? The answer lies in the way `CMP` works—it carries out an implied subtraction of the ASCII code for Zero (30h) from the character in the AL register. If the value in AL is smaller, the Carry flag is set, and the Zero flag is clear. (You may want to step through this code with a debugger to verify this fact.) The `JB` instruction is designed to transfer control to a label when `CF = 1` and `ZF = 0`.

Next, the code in the `IsDigit` procedure compares AL to the ASCII code for the digit 9. If the value is greater, the code jumps to the same label:

```
    cmp  al, '9'
    ja  ID1                ; ZF = 0 when jump taken
```

If the ASCII code for the character in AL is larger than the ASCII code of the digit 9 (39h), the Carry flag and Zero flag are cleared. That is exactly the flag combination that causes the `JA` instruction to transfer control to its target label.

If neither jump is taken (`JA` or `JB`), we assume that the character in AL is indeed a digit. Therefore, we insert an instruction that is guaranteed to set the Zero flag. To test any value with zero means to perform an implied `AND` with all zero bits. The result must be zero:

```
    test ax, 0              ; set ZF = 1
```

The `JB` and `JA` instructions we looked at earlier in `IsDigit` jumped to a label that was just beyond the `TEST` instruction. So if those jumps are taken, the Zero flag will be clear. Here is the complete procedure one more time:

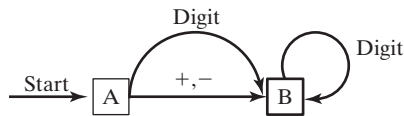
```
Isdigit PROC
    cmp  al, '0'
    jb  ID1                ; ZF = 0 when jump taken
    cmp  al, '9'
    ja  ID1                ; ZF = 0 when jump taken
    test ax, 0              ; set ZF = 1
ID1:  ret
Isdigit ENDP
```

In real-time or high-performance applications, programmers often take advantage of hardware characteristics to fully optimize their code. The `IsDigit` procedure is an example of this approach because it uses the flag settings of `JB`, `JA`, and `TEST` to return what is essentially a Boolean result.

### 6.6.3 Section Review

1. A finite-state machine is a specific application of what type of data structure?
2. In a finite-state machine diagram, what do the nodes represent?
3. In a finite-state machine diagram, what do the edges represent?

4. In the signed integer finite-state machine (Section 6.6.2), which state is reached when the input consists of “+5”?
5. In the signed integer finite-state machine (Section 6.6.2), how many digits can occur after a minus sign?
6. What happens in a finite-state machine when no more input is available and the current state is a nonterminal state?
7. Would the following simplification of a signed decimal integer finite-state machine work just as well as the one shown in Section 6.6.2? If not, why not?



## 6.7 Conditional Control Flow Directives

In 32-bit mode, MASM includes a number of high-level *conditional control flow directives* that help to simplify the coding of conditional statements. Unfortunately, they cannot be used in 64-bit mode. Before assembling your code, the assembler performs a preprocessing step. In this step, it recognizes directives such as `.CODE`, `.DATA`, as well as directives that can be used for conditional control flow. Table 6-7 lists the directives.

Table 6-7 Conditional Control Flow Directives.

Directive	Description
<code>.BREAK</code>	Generates code to terminate a <code>.WHILE</code> or <code>.REPEAT</code> block
<code>.CONTINUE</code>	Generates code to jump to the top of a <code>.WHILE</code> or <code>.REPEAT</code> block
<code>.ELSE</code>	Begins block of statements to execute when the <code>.IF</code> condition is false
<code>.ELSEIF <i>condition</i></code>	Generates code that tests <i>condition</i> and executes statements that follow, until an <code>.ENDIF</code> directive or another <code>.ELSEIF</code> directive is found
<code>.ENDIF</code>	Terminates a block of statements following an <code>.IF</code> , <code>.ELSE</code> , or <code>.ELSEIF</code> directive
<code>.ENDW</code>	Terminates a block of statements following a <code>.WHILE</code> directive
<code>.IF <i>condition</i></code>	Generates code that executes the block of statements if <i>condition</i> is true.
<code>.REPEAT</code>	Generates code that repeats execution of the block of statements until <i>condition</i> becomes true
<code>.UNTIL <i>condition</i></code>	Generates code that repeats the block of statements between <code>.REPEAT</code> and <code>.UNTIL</code> until <i>condition</i> becomes true
<code>.UNTILCXZ</code>	Generates code that repeats the block of statements between <code>.REPEAT</code> and <code>.UNTILCXZ</code> until <i>CX</i> equals zero
<code>.WHILE <i>condition</i></code>	Generates code that executes the block of statements between <code>.WHILE</code> and <code>.ENDW</code> as long as <i>condition</i> is true

### 6.7.1 Creating IF Statements

The `.IF`, `.ELSE`, `.ELSEIF`, and `.ENDIF` directives make it easy for you to code multiway branching logic. They cause the assembler to generate `CMP` and conditional jump instructions in the background, which appear in the output listing file (*prognamelist*). This is the syntax:

```
.IF condition1
    statements
[.ELSEIF condition2
    statements ]
[.ELSE
    statements ]
.ENDIF
```

The square brackets show that `.ELSEIF` and `.ELSE` are optional, whereas `.IF` and `.ENDIF` are required. A *condition* is a boolean expression involving the same operators used in C++ and Java (such as `<`, `>`, `==`, and `!=`). The expression is evaluated at runtime. The following are examples of valid conditions, using 32-bit registers and variables:

```
eax > 10000h
val1 <= 100
val2 == eax
val3 != ebx
```

The following are examples of compound conditions:

```
(eax > 0) && (eax > 10000h)
(val1 <= 100) || (val2 <= 100)
(val2 != ebx) && !CARRY?
```

A complete list of relational and logical operators is shown in Table 6-8.

Table 6-8 Runtime Relational and Logical Operators.

Operator	Description
<code>expr1 == expr2</code>	Returns true when <i>expr1</i> is equal to <i>expr2</i> .
<code>expr1 != expr2</code>	Returns true when <i>expr1</i> is not equal to <i>expr2</i> .
<code>expr1 &gt; expr2</code>	Returns true when <i>expr1</i> is greater than <i>expr2</i> .
<code>expr1 ≥ expr2</code>	Returns true when <i>expr1</i> is greater than or equal to <i>expr2</i> .
<code>expr1 &lt; expr2</code>	Returns true when <i>expr1</i> is less than <i>expr2</i> .
<code>expr1 ≤ expr2</code>	Returns true when <i>expr1</i> is less than or equal to <i>expr2</i> .
<code>! expr</code>	Returns true when <i>expr</i> is false.
<code>expr1 &amp;&amp; expr2</code>	Performs logical AND between <i>expr1</i> and <i>expr2</i> .
<code>expr1    expr2</code>	Performs logical OR between <i>expr1</i> and <i>expr2</i> .
<code>expr1 &amp; expr2</code>	Performs bitwise AND between <i>expr1</i> and <i>expr2</i> .
<code>CARRY?</code>	Returns true if the Carry flag is set.
<code>OVERFLOW?</code>	Returns true if the Overflow flag is set.
<code>PARITY?</code>	Returns true if the Parity flag is set.
<code>SIGN?</code>	Returns true if the Sign flag is set.
<code>ZERO?</code>	Returns true if the Zero flag is set.

Before using MASM conditional directives, be sure you thoroughly understand how to implement conditional branching instructions in pure assembly language. In addition, when a program containing decision directives is assembled, inspect the listing file to make sure the code generated by MASM is what you intended.

**Generating ASM Code** When you use high-level directives such as `.IF` and `.ELSE`, the assembler writes code for you. For example, let's write an `.IF` directive that compares `EAX` to the variable `val1`:

```
mov eax,6
.if eax > val1
    mov result,1
.endif
```

`val1` and `result` are assumed to be 32-bit unsigned integers. When the assembler reads the foregoing lines, it expands them into the following assembly language instructions, which you can view if you run the program in the Visual Studio debugger, right-click, and select *Go to Disassembly*.

```
mov    eax,6
cmp    eax,val1
jbe    @C0001           ; jump on unsigned comparison
mov    result,1
@C0001:
```

The label name `@C0001` was created by the assembler. This is done in a way that guarantees that all labels within same procedure are unique.

To control whether or not MASM-generated code appears in the source listing file, you can configure the Project properties in Visual Studio. Here's how: from the Project menu, select *Project Properties*, select *Microsoft Macro Assembler*, select *Listing File*, and set *Enable Assembly Generated Code Listing* to Yes.

## 6.7.2 Signed and Unsigned Comparisons

When you use the `.IF` directive to compare values, you must be aware of how MASM generates conditional jumps. If the comparison involves an unsigned variable, an unsigned conditional jump instruction is inserted in the generated code. This is a repeat of a previous example that compares `EAX` to `val1`, an unsigned doubleword:

```
.data
val1 DWORD    5
result DWORD  ?
.code
mov eax,6
.if eax > val1
    mov result,1
.endif
```

The assembler expands this using the `JBE` (unsigned jump) instruction:

```
mov eax,6
cmp eax,val1
```

```

        jbe @C0001                ; jump on unsigned comparison
        mov result,1
    @C0001:

```

**Comparing a Signed Integer** If an `.IF` directive compares a signed variable, however, a signed conditional jump instruction is inserted into the generated code. For example, `val2`, is a signed doubleword:

```

.data
val2 SDWORD -1
result DWORD ?
.code
    mov eax,6
    .IF eax > val2
        mov result,1
    .ENDIF

```

Consequently, the assembler generates code using the `JLE` instruction, a jump based on signed comparisons:

```

        mov eax,6
        cmp eax,val2
        jle @C0001                ; jump on signed comparison
        mov result,1
    @C0001:

```

**Comparing Registers** The question we might then ask is, what happens if two registers are compared? Clearly, the assembler cannot determine whether the values are signed or unsigned:

```

    mov eax,6
    mov ebx,val2
    .IF eax > ebx
        mov result,1
    .ENDIF

```

The following code is generated, showing that the assembler defaults to an unsigned comparison (note the use of the `JBE` instruction):

```

        mov  eax,6
        mov  ebx,val2
        cmp  eax, ebx
        jbe  @C0001
        mov  result,1
    @C0001:

```

### 6.7.3 Compound Expressions

Many compound boolean expressions use the logical OR and AND operators. When using the `.IF` directive, the `||` symbol is the logical OR operator:

```

    .IF expression1 || expression2
        statements
    .ENDIF

```

Similarly, the `&&` symbol is the logical AND operator:

```
.IF expression1 && expression2
    statements
.ENDIF
```

The logical OR operator will be used in the next program example.

### **SetCursorPosition Example**

The **SetCursorPosition** procedure, shown in the next example, performs range checking on its two input parameters, `DH` and `DL` (see *SetCur.asm*). The Y-coordinate (`DH`) must be between 0 and 24. The X-coordinate (`DL`) must be between 0 and 79. If either is found to be out of range, an error message is displayed:

```
SetCursorPosition PROC
; Sets the cursor position.
; Receives: DL = X-coordinate, DH = Y-coordinate.
; Checks the ranges of DL and DH.
; Returns: nothing
;-----
.data
BadXCoordMsg BYTE "X-Coordinate out of range!",0Dh,0Ah,0
BadYCoordMsg BYTE "Y-Coordinate out of range!",0Dh,0Ah,0
.code
    .IF (dl < 0) || (dl > 79)
        mov  edx,OFFSET BadXCoordMsg
        call WriteString
        jmp  quit
    .ENDIF
    .IF (dh < 0) || (dh > 24)
        mov  edx,OFFSET BadYCoordMsg
        call WriteString
        jmp  quit
    .ENDIF
    call Gotoxy
quit:
    ret
SetCursorPosition ENDP
```

The following code is generated by MASM when it preprocesses `SetCursorPosition`:

```
.code
; .IF (dl < 0) || (dl > 79)
    cmp  dl, 000h
    jb   @C0002
    cmp  dl, 04Fh
    jbe  @C0001
```



```

@C0002:
    mov     edx,OFFSET BadXCoordMsg
    call   WriteString
    jmp    quit
; .ENDIF

@C0001:
; .IF (dh < 0) || (dh > 24)

    cmp    dh, 000h
    jb     @C0005
    cmp    dh, 018h
    jbe    @C0004

@C0005:
    mov     edx,OFFSET BadYCoordMsg
    call   WriteString
    jmp    quit
; .ENDIF

@C0004:
    call   Gotoxy

quit:
    ret

```

### College Registration Example

Suppose a college student wants to register for courses. We will use two criteria to determine whether or not the student can register: The first is the person's grade average, based on a 0 to 400 scale, where 400 is the highest possible grade. The second is the number of credits the person wants to take. A multiway branch structure can be used, involving `.IF`, `.ELSEIF`, and `.ENDIF`. The following shows an example (see *Regist.asm*):

```

.data
TRUE = 1
FALSE = 0
gradeAverage WORD 275          ; test value
credits      WORD 12           ; test value
OkToRegister BYTE ?
.code
    mov OkToRegister,FALSE
    .IF gradeAverage > 350
        mov OkToRegister,TRUE
    .ELSEIF (gradeAverage > 250) && (credits <= 16)
        mov OkToRegister,TRUE
    .ELSEIF (credits <= 12)
        mov OkToRegister,TRUE
    .ENDIF

```

Table 6-9 lists the corresponding code generated by the assembler, which you can view by looking at the *Dissassembly* window of the Microsoft Visual Studio debugger. (It has been cleaned up here a bit to make it easier to read.) MASM-generated code will appear in the source listing file if you use the `/Sg` command-line option when assembling programs. The size of a

defined constants (such as TRUE or FALSE in the current code example) is 32-bits. Therefore, when a constant is moved to a BYTE address, MASM inserts the BYTE PTR operator.

Table 6-9 Registration Example, MASM-Generated Code.

```

mov byte ptr OkToRegister, FALSE
cmp word ptr gradeAverage, 350
jbe @C0006
mov byte ptr OkToRegister, TRUE
jmp @C0008
@C0006:
cmp word ptr gradeAverage, 250
jbe @C0009
cmp word ptr credits, 16
ja @C0009
mov byte ptr OkToRegister, TRUE
jmp @C0008
@C0009:
cmp word ptr credits, 12
ja @C0008
mov byte ptr OkToRegister, TRUE
@C0008:

```

#### 6.7.4 Creating Loops with .REPEAT and .WHILE

The .REPEAT and .WHILE directives offer alternatives to writing your own loops with CMP and conditional jump instructions. They permit the conditional expressions listed earlier in Table 6-8. The .REPEAT directive executes the loop body before testing the runtime condition following the .UNTIL directive:

```

.REPEAT
    statements
.UNTIL condition

```

The .WHILE directive tests the condition before executing the loop:

```

.WHILE condition
    statements
.ENDW

```

*Examples:* The following statements display the values 1 through 10 using the .WHILE directive. The counter register (EAX) is initialized to zero before the loop. Then, in the first statement inside the loop, EAX is incremented. The .WHILE directive branches out of the loop when EAX equals 10.

```

mov eax, 0
.WHILE eax < 10
    inc eax
    call WriteDec
    call Crlf
.ENDW

```

The following statements display the values 1 through 10 using the `.REPEAT` directive:

```
mov eax,0
.REPEAT
    inc eax
    call WriteDec
    call Crlf
.UNTIL eax == 10
```

### Example: Loop Containing an IF Statement

Earlier in this chapter, in Section 6.5.3, we showed how to write assembly language code for an IF statement nested inside a WHILE loop. Here is the pseudocode:

```
while( op1 < op2 )
{
    op1++;
    if( op1 == op3 )
        X = 2;
    else
        X = 3;
}
```

The following is an implementation of the pseudocode using the `.WHILE` and `.IF` directives. Because **op1**, **op2**, and **op3** are variables, they are moved to registers to avoid having two memory operands in any one instruction:

```
.data
X    DWORD 0
op1  DWORD 2           ; test data
op2  DWORD 4           ; test data
op3  DWORD 5           ; test data
.code
    mov eax,op1
    mov ebx,op2
    mov ecx,op3
    .WHILE eax < ebx
        inc eax
        .IF eax == ecx
            mov X,2
        .ELSE
            mov X,3
        .ENDIF
    .ENDW
```

## 6.8 Chapter Summary

The AND, OR, XOR, NOT, and TEST instructions are called *bitwise instructions* because they work at the bit level. Each bit in a source operand is matched to a bit in the same position of the destination operand:

- The AND instruction produces 1 when both input bits are 1.
- The OR instruction produces 1 when at least one of the input bits is 1.
- The XOR instruction produces 1 only when the input bits are different.

- The TEST instruction performs an implied AND operation on the destination operand, setting the flags appropriately. The destination operand is not changed.
- The NOT instruction reverses all bits in a destination operand.

The CMP instruction compares a destination operand to a source operand. It performs an implied subtraction of the source from the destination and modifies the CPU status flags accordingly. CMP is usually followed by a conditional jump instruction that transfers control to a code label.

Four types of conditional jump instructions are shown in this chapter:

- Table 6-2 contains examples of jumps based on specific flag values, such as JC (jump carry), JZ (jump zero), and JO (jump overflow).
- Table 6-3 contains examples of jumps based on equality, such as JE (jump equal), JNE (jump not equal), and JECXZ (jump if ECX = 0), and JRCXZ (jump if RCX = 0).
- Table 6-4 contains examples of conditional jumps based on comparisons of unsigned integers, such as JA (jump if above), JB (jump if below), and JAE (jump if above or equal).
- Table 6-5 contains examples of jumps based on signed comparisons, such as JL (jump if less) and JG (jump if greater).

In 32-bit mode, the LOOPZ (LOOPE) instruction repeats when the Zero flag is set and ECX is greater than Zero. The LOOPNZ (LOOPNE) instruction repeats when the Zero flag is clear and ECX is greater than zero. In 64-bit mode, the RCX register is used by the LOOPZ and LOOPNZ instructions.

*Encryption* is a process that encodes data, and *decryption* is a process that decodes data. The XOR instruction can be used to perform simple encryption and decryption.

Flowcharts are an effective tool for visually representing program logic. You can easily write assembly language code, using a flowchart as a model. It is helpful to attach a label to each flowchart symbol and use the same label in your assembly source code.

A *finite-state machine* (FSM) is an effective tool for validating strings containing recognizable characters such as signed integers. It is relatively easy to implement a FSM in assembly language if each state is represented by a label.

The .IF, .ELSE, .ELSEIF, and .ENDIF directives evaluate runtime expressions and greatly simplify assembly language coding. They are particularly useful when coding complex compound boolean expressions. You can also create conditional loops, using the .WHILE and .REPEAT directives.

## 6.9 Key Terms

### 6.9.1 Terms

bit-mapped set

bit mask

bit vector

boolean expression

cipher text

compound expression

conditional branching

conditional control flow directives

conditional structure

decryption

directed graph

edge

encryption

finite-state machine (FSM)

initial state	set intersection
key (encryption)	set union
logical AND operator	short-circuit evaluation
logical OR operator	symmetric encryption
masking (bits)	terminal state
node	table-driven selection
plain text	white box testing
set complement	

## 6.9.2 Instructions, Operators, and Directives

AND	JRCXZ	JNL
.BREAK	JG	JNP
CMP	JGE	JNS
.CONTINUE	JL	JNZ
.ELSE	JLE	LOOPE
.ELSEIF	JP	LOOPNE
.ENDIF	JS	LOOPZ
.ENDW	JZ	LOOPNZ
.IF	JNA	NOT
JA	JNAE	OR
JAE	JNB	.REPEAT
JB	JNBE	TEST
JBE	JNC	.UNTIL
JC	JNE	.UNTILCXZ
JE	JNG	.WHILE
JECXZ	JNGE	XOR

## 6.10 Review Questions and Exercises

### 6.10.1 Short Answer

- What will be the value of BX after the following instructions execute?
 

```
mov  bx, 0FFFFh
and  bx, 6Bh
```
- What will be the value of BX after the following instructions execute?
 

```
mov  bx, 91BAh
and  bx, 92h
```
- What will be the value of BX after the following instructions execute?
 

```
mov  bx, 0649Bh
or   bx, 3Ah
```

4. What will be the value of BX after the following instructions execute?

```
mov  bx,029D6h
xor  bx,8181h
```

5. What will be the value of EBX after the following instructions execute?

```
mov  ebx,0AF6F649Bh
or   ebx,3A219604h
```

6. What will be the value of RBX after the following instructions execute?

```
mov  rbx,0AF6F649Bh
xor  rbx,0FFFFFFFh
```

7. In the following instruction sequence, show the resulting value of AL where indicated, in binary:

```
mov  al,01101111b
and  al,00101101b           ; a.
mov  al,6Dh
and  al,4Ah                 ; b.
mov  al,00001111b
or   al,61h                 ; c.
mov  al,94h
xor  al,37h                 ; d.
```

8. In the following instruction sequence, show the resulting value of AL where indicated, in hexadecimal:

```
mov  al,7Ah
not  al                     ; a.
mov  al,3Dh
and  al,74h                 ; b.
mov  al,9Bh
or   al,35h                 ; c.
mov  al,72h
xor  al,0DCh                ; d.
```

9. In the following instruction sequence, show the values of the Carry, Zero, and Sign flags where indicated:

```
mov  al,00001111b
test al,00000010b          ; a. CF=   ZF=   SF=
mov  al,00000110b
cmp  al,00000101b          ; b. CF=   ZF=   SF=
mov  al,00000101b
cmp  al,00000111b          ; c. CF=   ZF=   SF=
```

10. Which conditional jump instruction executes a branch based on the contents of ECX?

11. How are JA and JNBE affected by the Zero and Carry flags?

12. What will be the final value in EDX after this code executes?

```
mov  edx,1
mov  eax,7FFFh
cmp  eax,8000h
jl   L1
mov  edx,0
```

L1:

13. What will be the final value in EDX after this code executes?

```

mov  edx, 1
mov  eax, 7FFFh
cmp  eax, 8000h
jb   L1
mov  edx, 0

```

L1:

14. What will be the final value in EDX after this code executes?

```

mov  edx, 1
mov  eax, 7FFFh
cmp  eax, 0FFFF8000h
jl   L2
mov  edx, 0

```

L2:

15. (*True/False*): The following code will jump to the label named **Target**.

```

mov  eax, -30
cmp  eax, -50
jg   Target

```

16. (*True/False*): The following code will jump to the label named **Target**.

```

mov  eax, -42
cmp  eax, 26
ja   Target

```

17. What will be the value of RBX after the following instructions execute?

```

mov  rbx, 0FFFFFFFFFFFFFFFh
and  rbx, 80h

```

18. What will be the value of RBX after the following instructions execute?

```

mov  rbx, 0FFFFFFFFFFFFFFFh
and  rbx, 808080h

```

19. What will be the value of RBX after the following instructions execute?

```

mov  rbx, 0FFFFFFFFFFFFFFFh
and  rbx, 80808080h

```

### 6.10.2 Algorithm Workbench

- Write a single instruction that converts an ASCII digit in AL to its corresponding binary value. If AL already contains a binary value (00h to 09h), leave it unchanged.
- Write instructions that calculate the parity of a 32-bit memory operand. Hint: Use the formula presented earlier in this section: B0 XOR B1 XOR B2 XOR B3.
- Given two bit-mapped sets named SetX and SetY, write a sequence of instructions that generate a bit string in EAX that represents members in SetX that are not members of SetY.
- Write instructions that jump to label L1 when the unsigned integer in DX is less than or equal to the integer in CX.
- Write instructions that jump to label L2 when the signed integer in AX is greater than the integer in CX.

6. Write instructions that first clear bits 0 and 1 in AL. Then, if the destination operand is equal to zero, the code should jump to label L3. Otherwise, it should jump to label L4.
7. Implement the following pseudocode in assembly language. Use short-circuit evaluation and assume that val1 and X are 32-bit variables.

```

if( val1 > ecx ) AND ( ecx > edx )
    X = 1
else
    X = 2;

```

8. Implement the following pseudocode in assembly language. Use short-circuit evaluation and assume that X is a 32-bit variable.

```

if( ebx > ecx ) OR ( ebx > val1 )
    X = 1
else
    X = 2

```

9. Implement the following pseudocode in assembly language. Use short-circuit evaluation and assume that X is a 32-bit variable.

```

if( ebx > ecx AND ebx > edx ) OR ( edx > eax )
    X = 1
else
    X = 2

```

10. Implement the following pseudocode in assembly language. Use short-circuit evaluation and assume that A, B, and N are 32-bit signed integers.

```

while N > 0
    if N != 3 AND (N < A OR N > B)
        N = N - 2
    else
        N = N - 1
end while

```

## 6.11 Programming Exercises

### 6.11.1 Suggestions for Testing Your Code

We have a few suggestions on how you can test the code you write for the programming exercises in this chapter, and in future chapters.

- Always step through your program with a debugger the first time you test it. It's so easy to forget a small detail, and the debugger let's you see exactly what's going on.
- If the specifications call for a signed array, be sure to include some negative values.
- When a range of input values is specified, include test data that falls before, on, and after these boundaries.
- Create multiple test cases, using arrays of different lengths.
- When you're writing a program that writes to an array, the Visual Studio debugger is the best tool for evaluating your program's correctness. Use the debugger's *Memory* window to display the array, choosing either hexadecimal or decimal representation.



- Immediately after calling the procedure you're testing, call it a second time to verify that the procedure has preserved all registers. Here's an example:

```
mov esi,OFFSET array
mov ecx,count
call CalcSum ; returns sum in EAX
call CalcSum ; call second time to see if registers are preserved
```

Usually there is a single return value in EAX, which of course, cannot be preserved. For that reason, you usually should not use EAX as an input parameter.

- If you're planning to pass more than one array to a procedure, make sure you do not refer to the array by name inside the procedure. Instead, set ESI or EDI to the array's offset before calling your procedure. That means you will be using indirect addressing (such as [esi] or [edi]) inside the procedure.
- If you need to create a variable for use only inside the procedure, you can use the .data directive before the variable, and then follow it with the .code directive. Here's an example:

```
MyCoolProcedure PROC
.data
sum SDWORD ?
.code
    mov sum,0
    (etc.)
```

The variable will still be publicly visible, unlike local variables in languages like C++ or Java. But when you declare it inside a procedure, you're making it obvious that you do not plan to use it anywhere else. Of course, you must use a runtime instruction to initialize variables used inside a procedure, because you will call this procedure more than once. You don't want it to have any leftover value the second time the procedure is called.

### 6.11.2 Exercise Descriptions

#### ★ 1. Filling an Array

Create a procedure that fills an array of doublewords with  $N$  random integers, making sure the values fall within the range  $j\dots k$ , inclusive. When calling the procedure, pass a pointer to the array that will hold the data, pass  $N$ , and pass the values of  $j$  and  $k$ . Preserve all register values between calls to the procedure. Write a test program that calls the procedure twice, using different values for  $j$  and  $k$ . Verify your results using a debugger.

#### ★★ 2. Summing Array Elements in a Range

Create a procedure that returns the sum of all array elements falling within the range  $j\dots k$  (inclusive). Write a test program that calls the procedure twice, passing a pointer to a signed doubleword array, the size of the array, and the values of  $j$  and  $k$ . Return the sum in the EAX register, and preserve all other register values between calls to the procedure.

#### ★★ 3. Test Score Evaluation

Create a procedure named *CalcGrade* that receives an integer value between 0 and 100, and returns a single capital letter in the AL register. Preserve all other register values between calls

to the procedure. The letter returned by the procedure should be according to the following ranges:

Score Range	Letter Grade
90 to 100	A
80 to 89	B
70 to 79	C
60 to 69	D
0 to 59	F

Write a test program that generates 10 random integers between 50 and 100, inclusive. Each time an integer is generated, pass it to the *CalcGrade* procedure. You can test your program using a debugger, or if you prefer to use the book's library, you can display each integer and its corresponding letter grade. (*The Irvine32 library is required for this solution program because it uses the RandomRange procedure.*)

#### ★★ 4. College Registration

Using the *College Registration* example from Section 6.7.3 as a starting point, do the following:

- Recode the logic using `CMP` and conditional jump instructions (instead of the `.IF` and `.ELSEIF` directives).
- Perform range checking on the credits value; it cannot be less than 1 or greater than 30. If an invalid entry is discovered, display an appropriate error message.
- Prompt the user for the grade average and credits values.
- Display a message that shows the outcome of the evaluation, such as “The student can register” or “The student cannot register”.

(*The Irvine32 library is required for this solution program.*)

#### ★★★ 5. Boolean Calculator (1)

Create a program that functions as a simple boolean calculator for 32-bit integers. It should display a menu that asks the user to make a selection from the following list:

1. `x AND y`
2. `x OR y`
3. `NOT x`
4. `x XOR y`
5. Exit program

When the user makes a choice, call a procedure that displays the name of the operation about to be performed. You must implement this procedure using the *Table-Driven Selection* technique, shown in Section 6.5.4. (You will implement the operations in Exercise 6.) (*The Irvine32 library is required for this solution program.*)

#### ★★★ 6. Boolean Calculator (2)

Continue the solution program from Exercise 5 by implementing the following procedures:

- `AND_op`: Prompt the user for two hexadecimal integers. AND them together and display the result in hexadecimal.

- **OR\_op:** Prompt the user for two hexadecimal integers. OR them together and display the result in hexadecimal.
- **NOT\_op:** Prompt the user for a hexadecimal integer. NOT the integer and display the result in hexadecimal.
- **XOR\_op:** Prompt the user for two hexadecimal integers. Exclusive-OR them together and display the result in hexadecimal.

*(The Irvine32 library is required for this solution program.)*

★★ **7. Probabilities and Colors**

Write a program that randomly chooses among three different colors for displaying text on the screen. Use a loop to display 20 lines of text, each with a randomly chosen color. The probabilities for each color are to be as follows: white = 30%, blue = 10%, green = 60%. Suggestion: Generate a random integer between 0 and 9. If the resulting integer falls in the range 0 to 2 (inclusive), choose white. If the integer equals 3, choose blue. If the integer falls in the range 4 to 9 (inclusive), choose green. Test your program by running it ten times, each time observing whether the distribution of line colors appears to match the required probabilities. *(The Irvine32 library is required for this solution program.)*

★★★ **8. Message Encryption**

Revise the encryption program in Section 6.3.4 in the following manner: Create an encryption key consisting of multiple characters. Use this key to encrypt and decrypt the plaintext by XOR-ing each character of the key against a corresponding byte in the message. Repeat the key as many times as necessary until all plain text bytes are translated. Suppose, for example, the key were equal to “ABXmv#7”. This is how the key would align with the plain text bytes:

Plain text	T	h	i	s		i	s		a		P	l	a	i	n	t	e	x	t		m	e	s	s	a	g	e	(etc.)
Key	A	B	X	m	v	#	7	A	B	X	m	v	#	7	A	B	X	m	v	#	7	A	8	X	m	v	#	7

(The key repeats until it equals the length of the plain text...)

★★ **9. Validating a PIN**

Banks use a Personal Identification Number (PIN) to uniquely identify each customer. Let us assume that our bank has a specified range of acceptable values for each digit in its customers’ 5-digit PINs. The table shown below contains the acceptable ranges, where digits are numbered from left to right in the PIN. Then we can see that the PIN 52413 is valid. But the PIN 43534 is invalid because the first digit is out of range. Similarly, 64535 is invalid because of its last digit.

Digit Number	Range
1	5 to 9
2	2 to 5
3	4 to 8
4	1 to 4
5	3 to 6

Your task is to create a procedure named *Validate\_PIN* that receives a pointer to an array of byte containing a 5-digit PIN. Declare two arrays to hold the minimum and maximum range values, and use these arrays to validate each digit of the PIN that was passed to the procedure. If any digit is found to be outside its valid range, immediately return the digit's position (between 1 and 5) in the EAX register. If the entire PIN is valid, return 0 in EAX. Preserve all other register values between calls to the procedure. Write a test program that calls *Validate\_PIN* at least four times, using both valid and invalid byte arrays. By running the program in a debugger, verify that the return value in EAX after each procedure call is valid. Or, if you prefer to use the book's library, you can display "Valid" or "Invalid" on the console after each procedure call.

### ★★★★ 10. Parity Checking

Data transmission systems and file subsystems often use a form of error detection that relies on calculating the parity (even or odd) of blocks of data. Your task is to create a procedure that returns True in the EAX register if the bytes in an array contain even parity, or False if the parity is odd. In other words, if you count all the bits in the entire array, their count will be even or odd. Preserve all other register values between calls to the procedure. Write a test program that calls your procedure twice, each time passing it a pointer to an array and the length of the array. The procedure's return value in EAX should be 1 (True) or 0 (False). For test data, create two arrays containing at least 10 bytes, one having even parity, and another having odd parity.

**Tip:** Earlier in this chapter, we showed how you can repeatedly apply the XOR instruction to a sequence of byte values to determine their parity. So, this suggests the use of a loop. But be careful, since some machine instructions affect the Parity flag, and others do not. You can find this out by looking at the individual instructions in Appendix B. The code in your loop that checks the parity will have to carefully save and restore the state of the Parity flag to avoid having it unintentionally modified by your code.

---

# INTEGER ARITHMETIC

- 7.1 Shift and Rotate Instructions**
  - 7.1.1 Logical Shifts and Arithmetic Shifts
  - 7.1.2 SHL Instruction
  - 7.1.3 SHR Instruction
  - 7.1.4 SAL and SAR Instructions
  - 7.1.5 ROL Instruction
  - 7.1.6 ROR Instruction
  - 7.1.7 RCL and RCR Instructions
  - 7.1.8 Signed Overflow
  - 7.1.9 SHLD/SHRD Instructions
  - 7.1.10 Section Review
- 7.2 Shift and Rotate Applications**
  - 7.2.1 Shifting Multiple Doublewords
  - 7.2.2 Binary Multiplication
  - 7.2.3 Displaying Binary Bits
  - 7.2.4 Extracting File Date Fields
  - 7.2.5 Section Review
- 7.3 Multiplication and Division Instructions**
  - 7.3.1 MUL Instruction
  - 7.3.2 IMUL Instruction
  - 7.3.3 Measuring Program Execution Times
  - 7.3.4 DIV Instruction
  - 7.3.5 Signed Integer Division
  - 7.3.6 Implementing Arithmetic Expressions
  - 7.3.7 Section Review
- 7.4 Extended Addition and Subtraction**
  - 7.4.1 ADC Instruction
  - 7.4.2 Extended Addition Example
  - 7.4.3 SBB Instruction
  - 7.4.4 Section Review
- 7.5 ASCII and Unpacked Decimal Arithmetic**
  - 7.5.1 AAA Instruction
  - 7.5.2 AAS Instruction
  - 7.5.3 AAM Instruction
  - 7.5.4 AAD Instruction
  - 7.5.5 Section Review
- 7.6 Packed Decimal Arithmetic**
  - 7.6.1 DAA Instruction
  - 7.6.2 DAS Instruction
  - 7.6.3 Section Review
- 7.7 Chapter Summary**
- 7.8 Key Terms**
  - 7.8.1 Terms
  - 7.8.2 Instructions, Operators, and Directives
- 7.9 Review Questions and Exercises**
  - 7.9.1 Short Answer
  - 7.9.2 Algorithm Workbench
- 7.10 Programming Exercises**

This chapter introduces the fundamental binary shift and rotation techniques, playing to one of the great strengths of assembly language. In fact, bit manipulation is an intrinsic part of computer graphics, data encryption, and hardware manipulation. Instructions that do this are powerful tools, and are only partially implemented by high-level languages, and somewhat obscured by their need to be platform-independent. We show quite a few ways you can apply bit shifting, including optimized multiplication and division.

Arithmetic with arbitrary-length integers is not supported by all high-level languages. But assembly language instructions make it possible to add and subtract integers of virtually any size. You will also be exposed to specialized instructions that perform arithmetic on packed decimal integers and integer strings.

## 7.1 Shift and Rotate Instructions

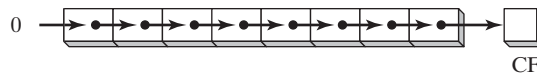
Along with bitwise instructions introduced in Chapter 6, shift instructions are among the most characteristic of assembly language. *Bit shifting* means to move bits right and left inside an operand. x86 processors provide a particularly rich set of instructions in this area (Table 7-1), all affecting the Overflow and Carry flags.

TABLE 7-1 Shift and Rotate Instructions.

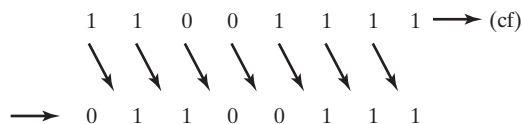
SHL	Shift left
SHR	Shift right
SAL	Shift arithmetic left
SAR	Shift arithmetic right
ROL	Rotate left
ROR	Rotate right
RCL	Rotate carry left
RCR	Rotate carry right
SHLD	Double-precision shift left
SHRD	Double-precision shift right

### 7.1.1 Logical Shifts and Arithmetic Shifts

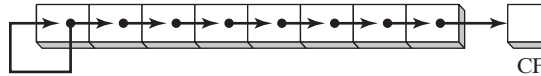
There are two ways to shift an operand's bits. The first, *logical shift*, fills the newly created bit position with zero. In the following illustration, a byte is logically shifted one position to the right. In other words, each bit is moved to the next lowest bit position. Note that bit 7 is assigned 0:



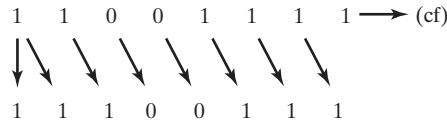
The following illustration shows a single logical right shift on the binary value 11001111, producing 01100111. The lowest bit is shifted into the Carry flag:



Another type of shift is called an *arithmetic shift*. The newly created bit position is filled with a copy of the original number's sign bit:

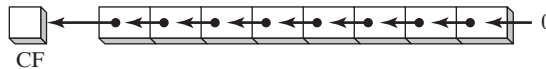


Binary 11001111, for example, has a 1 in the sign bit. When shifted arithmetically 1 bit to the right, it becomes 11100111:

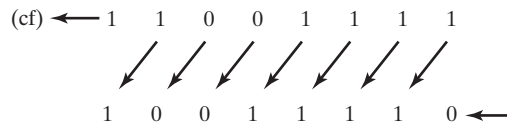


### 7.1.2 SHL Instruction

The SHL (shift left) instruction performs a logical left shift on the destination operand, filling the lowest bit with 0. The highest bit is moved to the Carry flag, and the bit that was in the Carry flag is discarded:



If you shift 11001111 left by 1 bit, it becomes 10011110:



The first operand in SHL is the destination and the second is the shift count:

```
SHL destination, count
```

The following lists the types of operands permitted by this instruction:

```
SHL reg, imm8
SHL mem, imm8
SHL reg, CL
SHL mem, CL
```

x86 processors permit *imm8* to be any integer between 0 and 255. Alternatively, the CL register can contain a shift count. Formats shown here also apply to the SHR, SAL, SAR, ROR, ROL, RCR, and RCL instructions.

**Example** In the following instructions, BL is shifted once to the left. The highest bit is copied into the Carry flag and the lowest bit position is assigned zero:

```
mov bl, 8Fh           ; BL = 10001111b
shl bl, 1             ; CF = 1, BL = 00011110b
```

When a value is shifted leftward multiple times, the Carry flag contains the last bit to be shifted out of the most significant bit (MSB). In the following example, bit 7 does not end up in the Carry flag because it is replaced by bit 6 (a zero):

```
mov  al,10000000b
shl  al,2                ; CF = 0, AL = 00000000b
```

Similarly, when a value is shifted rightward multiple times, the Carry flag contains the last bit to be shifted out of the least significant bit (LSB).

**Bitwise Multiplication** *Bitwise multiplication* is performed when you shift a number's bits in a leftward direction (toward the MSB). For example, SHL can perform multiplication by powers of 2. Shifting any operand left by  $n$  bits multiplies the operand by  $2^n$ . For example, shifting the integer 5 left by 1 bit yields the product of  $5 \times 2^1 = 10$ :

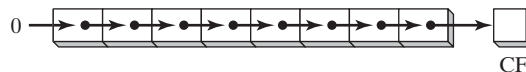
```
mov  dl,5      Before: 0 0 0 0 0 1 0 1 = 5
shl  dl,1      After:  0 0 0 0 1 0 1 0 = 10
```

If binary 00001010 (decimal 10) is shifted left by two bits, the result is the same as multiplying 10 by  $2^2$ :

```
mov  dl,10      ; before: 00001010
shl  dl,2      ; after:  00101000
```

### 7.1.3 SHR Instruction

The SHR (shift right) instruction performs a logical right shift on the destination operand, replacing the highest bit with a 0. The lowest bit is copied into the Carry flag, and the bit that was previously in the Carry flag is lost:



SHR uses the same instruction formats as SHL. In the following example, the 0 from the low-bit in AL is copied into the Carry flag, and the highest bit in AL is filled with a zero:

```
mov  al,0D0h      ; AL = 11010000b
shr  al,1         ; AL = 01101000b, CF = 0
```

In a multiple shift operation, the last bit to be shifted out of position 0 (the LSB) ends up in the Carry flag:

```
mov  al,00000010b
shr  al,2         ; AL = 00000000b, CF = 1
```

**Bitwise Division** *Bitwise division* is accomplished when you shift a number's bits in a rightward direction (toward the LSB). Shifting an unsigned integer right by  $n$  bits divides the operand by  $2^n$ . In the following statements, we divide 32 by  $2^1$ , producing 16:

```
mov  dl,32      Before: 0 0 1 0 0 0 0 0 = 32
shr  dl,1      After:  0 0 0 1 0 0 0 0 = 16
```



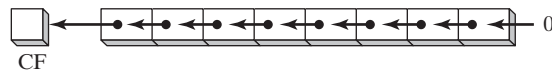
In the following example, 64 is divided by  $2^3$ :

```
mov al,01000000b      ; AL = 64
shr al,3              ; divide by 8, AL = 00001000b
```

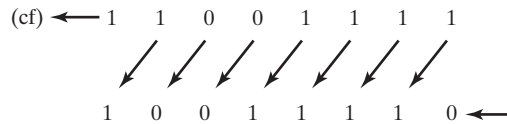
Division of signed numbers by shifting is accomplished using the SAR instruction because it preserves the number's sign bit.

#### 7.1.4 SAL and SAR Instructions

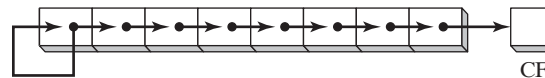
The SAL (shift arithmetic left) instruction works the same as the SHL instruction. For each shift count, SAL shifts each bit in the destination operand to the next highest bit position. The lowest bit is assigned 0. The highest bit is moved to the Carry flag, and the bit that was in the Carry flag is discarded:



If you shift binary 11001111 to the left by one bit, it becomes 10011110:



The SAR (shift arithmetic right) instruction performs a right arithmetic shift on its destination operand:



The operands for SAL and SAR are identical to those for SHL and SHR. The shift may be repeated, based on the counter in the second operand:

```
SAR destination, count
```

The following example shows how SAR duplicates the sign bit. AL is negative before and after it is shifted to the right:

```
mov al,0F0h          ; AL = 11110000b (-16)
sar al,1            ; AL = 11111000b (-8), CF = 0
```

**Signed Division** You can divide a signed operand by a power of 2, using the SAR instruction. In the following example,  $-128$  is divided by  $2^3$ . The quotient is  $-16$ :

```
mov dl,-128         ; DL = 10000000b
sar dl,3           ; DL = 11110000b
```

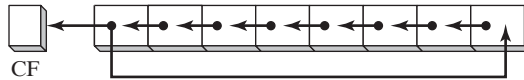
**Sign-Extend AX into EAX** Suppose AX contains a signed integer and you want to extend its sign into EAX. First shift EAX 16 bits to the left, then shift it arithmetically 16 bits to the right:

```
mov ax,-128        ; EAX = ????FF80h
shl eax,16         ; EAX = FF800000h
sar eax,16         ; EAX = FFFFFFFF80h
```

### 7.1.5 ROL Instruction

*Bitwise rotation* occurs when you move the bits in a circular fashion. In some versions, the bit leaving one end of the number is immediately copied into the other end. Another type of rotation uses the Carry flag as an intermediate point for shifted bits.

The ROL (rotate left) instruction shifts each bit to the left. The highest bit is copied into the Carry flag and the lowest bit position. The instruction format is the same as for SHL:



Bit rotation does not lose bits. A bit rotated off one end of a number appears again at the other end. Note in the following example how the high bit is copied into both the Carry flag and bit position 0:

```

mov  al,40h                ; AL = 01000000b
rol  al,1                  ; AL = 10000000b, CF = 0
rol  al,1                  ; AL = 00000001b, CF = 1
rol  al,1                  ; AL = 00000010b, CF = 0

```

**Multiple Rotations** When using a rotation count greater than 1, the Carry flag contains the last bit rotated out of the MSB position:

```

mov  al,00100000b
rol  al,3                  ; CF = 1, AL = 00000001b

```

**Exchanging Groups of Bits** You can use ROL to exchange the upper (bits 4–7) and lower (bits 0–3) halves of a byte. For example, 26h rotated four bits in either direction becomes 62h:

```

mov  al,26h
rol  al,4                  ; AL = 62h

```

When rotating a multibyte integer by four bits, the effect is to rotate each hexadecimal digit one position to the right or left. Here, for example, we repeatedly rotate 6A4Bh left four bits, eventually ending up with the original value:

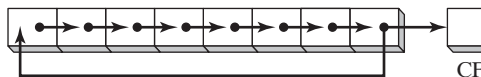
```

mov  ax,6A4Bh
rol  ax,4                  ; AX = A4B6h
rol  ax,4                  ; AX = 4B6Ah
rol  ax,4                  ; AX = B6A4h
rol  ax,4                  ; AX = 6A4Bh

```

### 7.1.6 ROR Instruction

The ROR (rotate right) instruction shifts each bit to the right and copies the lowest bit into the Carry flag and the highest bit position. The instruction format is the same as for SHL:



In the following examples, note how the lowest bit is copied into both the Carry flag and the highest bit position of the result:

```

mov  al,01h                ; AL = 00000001b
ror  al,1                  ; AL = 10000000b, CF = 1
ror  al,1                  ; AL = 01000000b, CF = 0

```

**Multiple Rotations** When using a rotation count greater than 1, the Carry flag contains the last bit rotated out of the LSB position:

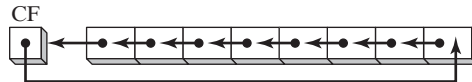
```

mov  al,00000100b
ror  al,3                  ; AL = 10000000b, CF = 1

```

### 7.1.7 RCL and RCR Instructions

The RCL (rotate carry left) instruction shifts each bit to the left, copies the Carry flag to the LSB, and copies the MSB into the Carry flag:



If we imagine the Carry flag as an extra bit added to the high end of the operand, RCL looks like a rotate left operation. In the following example, the CLC instruction clears the Carry flag. The first RCL instruction moves the high bit of BL into the Carry flag and shifts the other bits left. The second RCL instruction moves the Carry flag into the lowest bit position and shifts the other bits left:

```

clc                ; CF = 0
mov  bl,88h       ; CF,BL = 0 10001000b
rcl  bl,1         ; CF,BL = 1 00010000b
rcl  bl,1         ; CF,BL = 0 00100001b

```

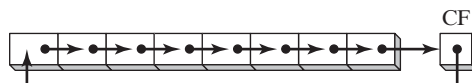
**Recover a Bit from the Carry Flag** RCL can recover a bit that was previously shifted into the Carry flag. The following example checks the lowest bit of `testval` by shifting its lowest bit into the Carry flag. If the lowest bit of `testval` is 1, a jump is taken; if the lowest bit is 0, RCL restores the number to its original value:

```

.data
testval BYTE 01101010b
.code
shr  testval,1    ; shift LSB into Carry flag
jc   exit        ; exit if Carry flag set
rcl  testval,1    ; else restore the number

```

**RCR Instruction** The RCR (rotate carry right) instruction shifts each bit to the right, copies the Carry flag into the MSB, and copies the LSB into the Carry flag:



As in the case of RCL, it helps to visualize the integer in this figure as a 9-bit value, with the Carry flag to the right of the LSB.

The following code example uses STC to set the Carry flag; then, it performs a rotate carry right operation on the AH register:

```

stc                ; CF = 1
mov ah,10h        ; AH, CF = 00010000 1
rcr ah,1          ; AH, CF = 10001000 0

```

### 7.1.8 Signed Overflow

The Overflow flag is set if the act of shifting or rotating a signed integer by one bit position generates a value outside the signed integer range of the destination operand. To put it another way, the number's sign is reversed. In the following example, a positive integer (+127) stored in an 8-bit register becomes negative (-2) when rotated left:

```

mov al,+127       ; AL = 01111111b
rol al,1          ; OF = 1, AL = 11111110b

```

Similarly, when -128 is shifted one position to the right, the Overflow flag is set. The result in AL (+64) has the opposite sign:

```

mov al,-128       ; AL = 10000000b
shr al,1          ; OF = 1, AL = 01000000b

```

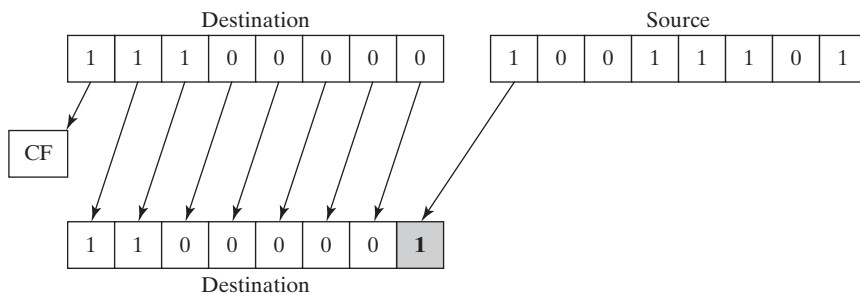
The value of the Overflow flag is undefined when the shift or rotation count is greater than 1.

### 7.1.9 SHLD/SHRD Instructions

The SHLD (shift left double) instruction shifts a destination operand a given number of bits to the left. The bit positions opened up by the shift are filled by the most significant bits of the source operand. The source operand is not affected, but the Sign, Zero, Auxiliary, Parity, and Carry flags are affected:

```
SHLD dest, source, count
```

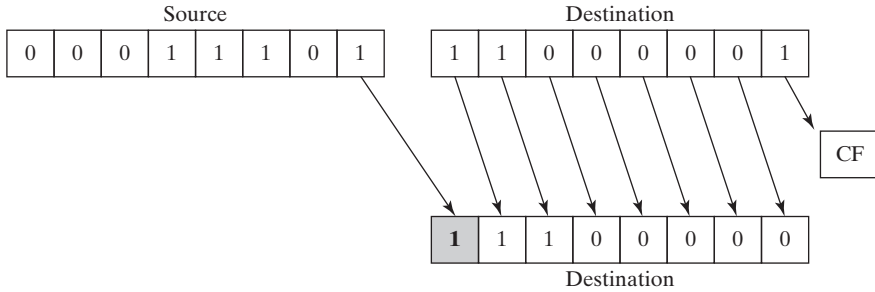
The following illustration shows the execution of SHLD with a shift count of 1. The highest bit of the source operand is copied into the lowest bit of the destination operand. All the destination operand bits are shifted left:



The SHRD (shift right double) instruction shifts a destination operand a given number of bits to the right. The bit positions opened up by the shift are filled by the least significant bits of the source operand:

```
SHRD dest, source, count
```

The following illustration shows the execution of SHRD with a shift count of 1:



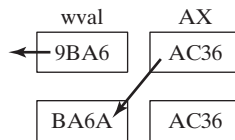
The following instruction formats apply to both SHLD and SHRD. The destination operand can be a register or memory operand, and the source operand must be a register. The count operand can be the CL register or an 8-bit immediate operand:

```
SHLD  reg16, reg16, CL/imm8
SHLD  mem16, reg16, CL/imm8
SHLD  reg32, reg32, CL/imm8
SHLD  mem32, reg32, CL/imm8
```

**Example 1** The following statements shift **wval** to the left 4 bits and insert the high 4 bits of AX into the low 4 bit positions of **wval**:

```
.data
wval WORD 9BA6h
.code
mov  ax, 0AC36h
shld wval, ax, 4           ; wval = BA6Ah
```

The data movement is shown in the following figure:



**Example 2** In the following example, **AX** is shifted to the right 4 bits, and the low 4 bits of **DX** are shifted into the high 4 positions of **AX**:

```
mov  ax, 234Bh
mov  dx, 7654h
shrd ax, dx, 4
```

The diagram illustrates the state of **DX** and **AX** before and after the SHRD instruction:

- Initial State:** **DX** = 7654h, **AX** = 234Bh.
- Final State:** **DX** = 7654h, **AX** = 4234h.

An arrow shows the low 4 bits of **DX** (42) moving into the high 4 bits of **AX** (42), and the original high 4 bits of **AX** (23) shifting to the low 4 bits of **AX**.

SHLD and SHRD can be used to manipulate bit-mapped images, when groups of bits must be shifted left and right to reposition images on the screen. Another potential application is data encryption, in which the encryption algorithm involves the shifting of bits. Finally, the two instructions can be used when performing fast multiplication and division with very long integers.

The following code example demonstrates SHRD by shifting an array of doublewords to the right by 4 bits:

```
.data
array DWORD 648B2165h,8C943A29h,6DFA4B86h,91F76C04h,8BAF9857h

.code
    mov     bl,4                ; shift count
    mov     esi,OFFSET array    ; offset of the array
    mov     ecx,(LENGTHOF array) - 1 ; number of array elements

L1:  push   ecx                ; save loop counter
     mov   eax,[esi + TYPE DWORD]
     mov   cl,bl              ; shift count
     shrd [esi],eax,cl        ; shift EAX into high bits of
                               ; [ESI]
     add  esi,TYPE DWORD      ; point to next doubleword pair
     pop  ecx                ; restore loop counter
     loop L1

     shr  DWORD PTR [esi],COUNT ; shift the last doubleword
```

### 7.1.10 Section Review

1. Which instruction shifts each bit in an operand to the left and copies the highest bit into both the Carry flag and the lowest bit position?
2. Which instruction shifts each bit to the right, copies the lowest bit into the Carry flag, and copies the Carry flag into the highest bit position?
3. Which instruction performs the following operation (CF = Carry flag)?

```
Before:  CF,AL = 1 11010101
After:   CF,AL = 1 10101011
```

4. What happens to the Carry flag when the SHR AX,1 instruction is executed?
5. *Challenge:* Write a series of instructions that shift the lowest bit of AX into the highest bit of BX without using the SHRD instruction. Next, perform the same operation using SHRD.
6. *Challenge:* One way to calculate the parity of a 32-bit number in EAX is to use a loop that shifts each bit into the Carry flag and accumulates a count of the number of times the Carry flag was set. Write a code that does this, and set the Parity flag accordingly.

## 7.2 Shift and Rotate Applications

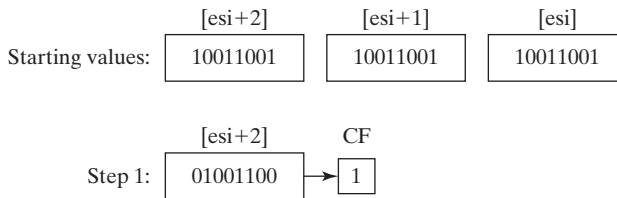
When a program needs to move bits from one part of an integer to another, assembly language is a great tool for the job. Sometimes, we move a subset of a number's bits to position 0 to make it easier to isolate the value of the bits. In this section, we show a few common bit shift and rotate applications that are easy to implement. More applications will be found in the chapter exercises.

### 7.2.1 Shifting Multiple Doublewords

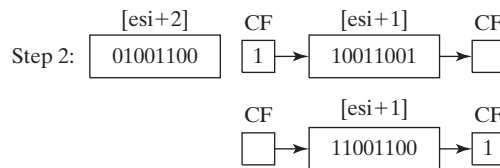
You can shift an extended-precision integer that has been divided into an array of bytes, words, or doublewords. Before doing this, you must know how the array elements are stored. A common way to store the integer is called *little-endian order*. It works like this: Place the low-order byte at the array's starting address. Then, working your way up from that byte to the high-order byte, store each in the next sequential memory location. Instead of storing the array as a series of bytes, you could store it as a series of words or doublewords. If you did so, the individual bytes would still be in little-endian order, because x86 machines store words and doublewords in little-endian order.

The following steps show how to shift an array of bytes 1 bit to the right:

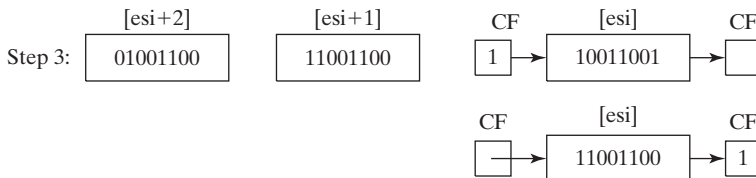
*Step 1:* Shift the highest byte at [ESI+2] to the right, automatically copying its lowest bit into the Carry flag.



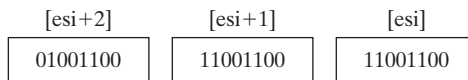
*Step 2:* Rotate the value at [ESI+1] to the right, filling the highest bit with the value of the Carry flag, and shifting the lowest bit into the Carry flag:



*Step 3:* Rotate the value at [ESI] to the right, filling the highest bit with the value of the Carry flag, and shifting the lowest bit into the Carry flag:



After Step 3 is complete, all bits have been shifted 1 position to the right:



The following code excerpt from the *Multishift.asm* program implements the steps we just outlined:

```
.data
ArraySize = 3
array BYTE ArraySize DUP(99h) ; 1001 pattern in each nybble
.code
main PROC
    mov esi,0
    shr array[esi+2],1          ; high byte
    rcr array[esi+1],1          ; middle byte, include Carry flag
    rcr array[esi],1           ; low byte, include Carry flag
```

Although our current example only shifts 3 bytes, the example could easily be modified to shift an array of words or doublewords. Using a loop, you could shift an array of arbitrary size.

### 7.2.2 Binary Multiplication

Sometimes programmers squeeze every performance advantage they can into integer multiplication by using bit shifting rather than the MUL instruction. The SHL instruction performs unsigned multiplication when the multiplier is a power of 2. Shifting an unsigned integer  $n$  bits to the left multiplies it by  $2^n$ . Any other multiplier can be expressed as the sum of powers of 2. For example, to multiply unsigned EAX by 36, we can write 36 as  $2^5 + 2^2$  and use the distributive property of multiplication:

$$\begin{aligned} \text{EAX} * 36 &= \text{EAX} * (2^5 + 2^2) \\ &= \text{EAX} * (32 + 4) \\ &= (\text{EAX} * 32) + (\text{EAX} * 4) \end{aligned}$$

The following figure shows the multiplication  $123 * 36$ , producing 4428, the product:

	01111011	123
	× 00100100	36
	01111011	123 SHL 2
+	01111011	123 SHL 5
	0001000101001100	4428

It is interesting to note that bits 2 and 5 are set in the multiplier (36), and the integers 2 and 5 are also the required shift counters. Using this information, the following code snippet multiplies 123 by 36, using SHL and ADD instructions:

```
mov eax,123
mov ebx,eax
shl eax,5          ; multiply by 25
shl ebx,2          ; multiply by 22
add eax,ebx        ; add the products
```

As a chapter programming exercise, you will be asked to generalize this example and create a procedure that multiplies any two 32-bit unsigned integers using shifting and addition.



### 7.2.3 Displaying Binary Bits

A common programming task is converting a binary integer to an ASCII binary string, allowing the latter to be displayed. The SHL instruction is useful in this regard because it copies the highest bit of an operand into the Carry flag each time the operand is shifted left. The following **BinToAsc** procedure is a simple implementation:

```

;-----
BinToAsc PROC
;
; Converts 32-bit binary integer to ASCII binary.
; Receives: EAX = binary integer, ESI points to buffer
; Returns: buffer filled with ASCII binary digits
;-----
    push ecx
    push esi

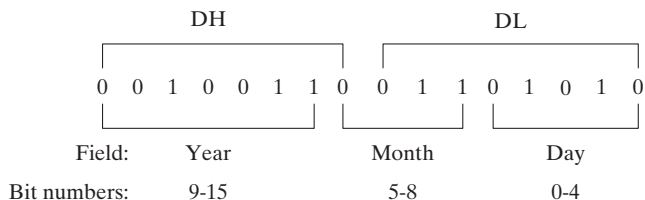
    mov ecx,32                ; number of bits in EAX
L1: shl eax,1                ; shift high bit into Carry flag
    mov BYTE PTR [esi],'0'   ; choose 0 as default digit
    jnc L2                    ; if no Carry, jump to L2
    mov BYTE PTR [esi],'1'   ; else move 1 to buffer
L2: inc esi                  ; next buffer position
    loop L1                   ; shift another bit to left

    pop esi
    pop ecx
    ret
BinToAsc ENDP

```

### 7.2.4 Extracting File Date Fields

When storage space is at a premium, system-level software often packs multiple data fields into a single integer. To uncover this data, applications often need to extract sequences of bits called *bit strings*. For example, in real-address mode, MS-DOS function 57h returns the date stamp of a file in DX. (The date stamp shows the date on which the file was last modified.) Bits 0 through 4 represent a day number between 1 and 31, bits 5 through 8 are the month number, and bits 9 through 15 hold the year number. If a file was last modified on March 10, 1999, the file's date stamp would appear as follows in the DX register (the year number is relative to 1980):



To extract a single bit string, shift its bits into the lowest part of a register and clear the irrelevant bit positions. The following code example extracts the day number field of a date stamp integer by making a copy of DL and masking off bits not belonging to the field:

```

mov al,dl                ; make a copy of DL
and al,00011111b        ; clear bits 5-7
mov day,al              ; save in day

```

To extract the month number field, we shift bits 5 through 8 into the low part of AL before masking off all other bits. AL is then copied into a variable:

```

mov ax,dx                ; make a copy of DX
shr ax,5                 ; shift right 5 bits
and al,00001111b        ; clear bits 4-7
mov month,al            ; save in month

```

The year number (bits 9 through 15) field is completely within the DH register. We copy it to AL and shift right by 1 bit:

```

mov al,dh                ; make a copy of DH
shr al,1                 ; shift right one position
mov ah,0                 ; clear AH to zeros
add ax,1980              ; year is relative to 1980
mov year,ax              ; save in year

```

### 7.2.5 Section Review

1. Write assembly language instructions that calculate  $EAX * 24$  using binary multiplication.
2. Write assembly language instructions that calculate  $EAX * 21$  using binary multiplication.  
*Hint:  $21 = 2^4 + 2^2 + 2^0$ .*
3. What change would you make to the BinToAsc procedure in Section 7.2.3 in order to display the binary bits in reverse order?
4. The time stamp field of a file directory entry uses bits 0 through 4 for the seconds, bits 5 through 10 for the minutes, and bits 11 through 15 for the hours. Write instructions that extract the minutes and copy the value to a byte variable named **bMinutes**.

## 7.3 Multiplication and Division Instructions

In 32-bit mode, integer multiplication can be performed as a 32-bit, 16-bit, or 8-bit operation. In 64-bit mode, you can also use 64-bit operands. The MUL and IMUL instructions perform unsigned and signed integer multiplication, respectively. The DIV instruction performs unsigned integer division, and IDIV performs signed integer division.

### 7.3.1 MUL Instruction

In 32-bit mode, the MUL (unsigned multiply) instruction comes in three versions: The first version multiplies an 8-bit operand by the AL register. The second version multiplies a 16-bit operand by the AX register, and the third version multiplies a 32-bit operand by the EAX register. The multiplier and multiplicand must always be the same size, and the product is twice their size. The three formats accept register and memory operands, but not immediate operands:

```

MUL reg/mem8
MUL reg/mem16
MUL reg/mem32

```

The single operand in the MUL instruction is the multiplier. Table 7-2 shows the default multiplicand and product, depending on the size of the multiplier. Because the destination operand is twice the size of the multiplicand and multiplier, overflow cannot occur. MUL sets the Carry and Overflow flags if the upper half of the product is not equal to zero. The Carry flag is ordinarily used for unsigned arithmetic, so we'll focus on it here. When AX is multiplied by a 16-bit operand, for example, the product is stored in the combined DX and AX registers. That is, the high 16 bits of the product are stored in DX, and the low 16 bits are stored in AX. The Carry flag is set if DX is not equal to zero, which lets us know that the product will not fit into the lower half of the implied destination operand.

Table 7-2 MUL Operands.

Multiplicand	Multiplier	Product
AL	reg/mem8	AX
AX	reg/mem16	DX:AX
EAX	reg/mem32	EDX:EAX

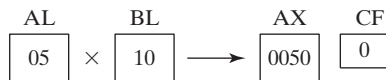
A good reason for checking the Carry flag after executing MUL is to know whether the upper half of the product can safely be ignored.

### MUL Examples

The following statements multiply AL by BL, storing the product in AX. The Carry flag is clear (CF = 0) because AH (the upper half of the product) equals zero:

```
mov  al,5h
mov  bl,10h
mul  bl                ; AX = 0050h, CF = 0
```

The following diagram illustrates the movement between registers:



The following statements multiply the 16-bit value 2000h by 0100h. The Carry flag is set because the upper part of the product (located in DX) is not equal to zero:

```
.data
val1 WORD 2000h
val2 WORD 0100h
.code
mov  ax,val1          ; AX = 2000h
mul  val2             ; DX:AX = 00200000h, CF = 1
```



The following statements multiply 12345h by 1000h, producing a 64-bit product in the combined EDX and EAX registers. The Carry flag is clear because the upper half of the product in EDX equals zero:

```
mov eax,12345h
mov ebx,1000h
mul ebx                ; EDX:EAX = 0000000012345000h, CF = 0
```

The following diagram illustrates the movement between registers:



### Using MUL in 64-Bit Mode

In 64-bit mode, you can use 64-bit operands with the MUL instruction. A 64-bit register or memory operand is multiplied against RDX, producing a 128-bit product in RDX:RAX. In the following example, each bit in RAX is shifted one position to the left when RAX is multiplied by 2. The highest bit of RAX spills over into the RDX register, which equals 0000000000000001 hexadecimal:

```
mov rax,0FFFF0000FFFF0000h
mov rbx,2
mul rbx                ; RDX:RAX = 0000000000000001FFFE0001FFFE0000
```

In the next example, we multiply RAX by a 64-bit memory operand. The value is being multiplied by 16, so each hexadecimal digit is shifted one position to the left (a 4-bit shift is the same as multiplying by 16).

```
.data
multiplier QWORD 10h
.code
mov rax,0AABBBBCCCCDDDDh
mul multiplier        ; RDX:RAX = 0000000000000000AABBBBCCCCDDDD0h
```

### 7.3.2 IMUL Instruction

The IMUL (signed multiply) instruction performs signed integer multiplication. Unlike the MUL instruction, IMUL preserves the sign of the product. It does this by sign extending the highest bit of the lower half of the product into the upper bits of the product. The x86 instruction set supports three formats for the IMUL instruction: one operand, two operands, and three operands. In the one-operand format, the multiplier and multiplicand are the same size and the product is twice their size.

**Single-Operand Formats** The one-operand formats store the product in AX, DX:AX, or EDX:EAX:

```
IMUL reg/mem8          ; AX = AL * reg/mem8
IMUL reg/mem16         ; DX:AX = AX * reg/mem16
IMUL reg/mem32         ; EDX:EAX = EAX * reg/mem32
```

As in the case of `MUL`, the storage size of the product makes overflow impossible. Also, the Carry and Overflow flags are set if the upper half of the product is not a sign extension of the lower half. You can use this information to decide whether to ignore the upper half of the product.

**Two-Operand Formats (32-Bit Mode)** The two-operand version of the `IMUL` instruction in 32-bit mode stores the product in the first operand, which must be a register. The second operand (the multiplier) can be a register, a memory operand, or an immediate value. Following are the 16-bit formats:

```
IMUL  reg16, reg/mem16
IMUL  reg16, imm8
IMUL  reg16, imm16
```

Following are the 32-bit operand types showing that the multiplier can be a 32-bit register, a 32-bit memory operand, or an immediate value (8 or 32 bits):

```
IMUL  reg32, reg/mem32
IMUL  reg32, imm8
IMUL  reg32, imm32
```

The two-operand formats truncate the product to the length of the destination. If significant digits are lost, the Overflow and Carry flags are set. Be sure to check one of these flags after performing an `IMUL` operation with two operands.

**Three-Operand Formats** The three-operand formats in 32-bit mode store the product in the first operand. The second operand can be a 16-bit register or memory operand, which is multiplied by the third operand, an 8- or 16-bit immediate value:

```
IMUL  reg16, reg/mem16, imm8
IMUL  reg16, reg/mem16, imm16
```

A 32-bit register or memory operand can be multiplied by an 8- or 32-bit immediate value:

```
IMUL  reg32, reg/mem32, imm8
IMUL  reg32, reg/mem32, imm32
```

If significant digits are lost when `IMUL` executes, the Overflow and Carry flags are set. Be sure to check one of these flags after performing an `IMUL` operation with three operands.

### Using `IMUL` in 64-Bit Mode

In 64-bit mode, you can use 64-bit operands with the `MUL` instruction. In the two-operand format, a 64-bit register or memory operand is multiplied against `RDX`, producing a 128-bit sign-extended product in `RDX:RAX`. In the next example, `RBX` is multiplied by `RAX`, producing a 128-bit product of  $-16$ .

```
mov  rax, -4
mov  rbx, 4
imul rb          ; RDX = 0FFFFFFFFFFFFFFFFh, RAX = -16
```

In other words, decimal  $-16$  is represented as `FFFFFFFFFFF0` hexadecimal in `RAX`, and `RDX` just contains an extension of `RAX`'s high-order bit, also known as its sign bit.

The three-operand format is also available in 64-bit mode. In the next example, we multiply the multiplicand ( $-16$ ) by 4, producing  $-64$  in the RAX register:

```
.data
multiplicand QWORD -16
.code
imul rax, multiplicand, 4           ; RAX = FFFFFFFF000000F0 (-64)
```

**Unsigned Multiplication** The two-operand and three-operand IMUL formats may also be used for unsigned multiplication because the lower half of the product is the same for signed and unsigned numbers. There is a small disadvantage to doing so: The Carry and Overflow flags will not indicate whether the upper half of the product equals zero.

### IMUL Examples

The following instructions multiply 48 by 4, producing  $+192$  in AX. Although the product is correct, AH is not a sign extension of AL, so the Overflow flag is set:

```
mov  al,48
mov  bl,4
imul bl                     ; AX = 00C0h, OF = 1
```

The following instructions multiply  $-4$  by 4, producing  $-16$  in AX. AH is a sign extension of AL, so the Overflow flag is clear:

```
mov  al,-4
mov  bl,4
imul bl                     ; AX = FFF0h, OF = 0
```

The following instructions multiply 48 by 4, producing  $+192$  in DX:AX. DX is a sign extension of AX, so the Overflow flag is clear:

```
mov  ax,48
mov  bx,4
imul bx                     ; DX:AX = 000000C0h, OF = 0
```

The following instructions perform 32-bit signed multiplication ( $4,823,424 * -423$ ), producing  $-2,040,308,352$  in EDX:EAX. The Overflow flag is clear because EDX is a sign extension of EAX:

```
mov  eax,+4823424
mov  ebx,-423
imul ebx                     ; EDX:EAX = FFFFFFFF86635D80h, OF = 0
```

The following instructions demonstrate two-operand formats:

```
.data
word1  SWORD 4
dword1 SDWORD 4
.code
mov  ax,-16                 ; AX = -16
mov  bx,2                   ; BX = 2
imul bx,ax                  ; BX = -32
imul bx,2                   ; BX = -64
```

```

imul bx,word1           ; BX = -256
mov  eax,-16           ; EAX = -16
mov  ebx,2             ; EBX = 2
imul ebx,eax          ; EBX = -32
imul ebx,2             ; EBX = -64
imul ebx,dword1       ; EBX = -256

```

The two-operand and three-operand IMUL instructions use a destination operand that is the same size as the multiplier. Therefore, it is possible for signed overflow to occur. Always check the Overflow flag after executing these types of IMUL instructions. The following two-operand instructions demonstrate signed overflow because  $-64,000$  cannot fit within the 16-bit destination operand:

```

mov  ax,-32000
imul ax,2              ; OF = 1

```

The following instructions demonstrate three-operand formats, including an example of signed overflow:

```

.data
word1  SWORD 4
dword1 SDWORD 4
.code
imul bx,word1,-16      ; BX = word1 * -16
imul ebx,dword1,-16   ; EBX = dword1 * -16
imul ebx,dword1,-2000000000 ; signed overflow!

```

### 7.3.3 Measuring Program Execution Times

Programmers often find it useful to compare the performance of one code implementation to another by measuring their performance times. The Microsoft Windows API provides the necessary tools to do this, which we have made even more accessible with the `GetMseconds` procedure in the `Irvine32` library. The procedure gets the number of system milliseconds that have elapsed since midnight. In the following code example, `GetMseconds` is called first, so we can record the system starting time. Then we call the procedure whose execution time we wish to measure (*FirstProcedureToTest*). Finally, `GetMseconds` is called a second time, and the difference between the current milliseconds value and the starting time is calculated:

```

.data
startTime DWORD ?
procTime1  DWORD ?
procTime2  DWORD ?
.code
call GetMseconds           ; get start time
mov  startTime,eax
.
call FirstProcedureToTest
.
call GetMseconds           ; get stop time
sub  eax,startTime        ; calculate the elapsed time
mov  procTime1,eax        ; save the elapsed time

```

There is, of course, a small amount of execution time used up by calling `GetMseconds` twice. But this overhead is insignificant when we measure the ratio of performance times between one code implementation and another. Here, we call the other procedure we wish to test, and save its execution time (*procTime2*):

```

    call GetMseconds           ; get start time
    mov  startTime,eax
    .
    call SecondProcedureToTest
    .
    call GetMseconds           ; get stop time
    sub  eax,startTime         ; calculate the elapsed time
    mov  procTime2,eax         ; save the elapsed time

```

Now, the ratio of *procTime1* to *procTime2* indicates the relative performance of the two procedures.

### **Comparing MUL and IMUL to Bit Shifting**

In older x86 processors, there was a significant difference in performance between multiplication by bit shifting versus multiplication using the `MUL` and `IMUL` instructions. We can use the `GetMseconds` procedure to compare the execution time of the two types of multiplication. The following two procedures perform multiplication repeatedly using a `LOOP_COUNT` constant to determine the amount of repetition:

```

mult_by_shifting PROC
;
; Multiplies EAX by 36 using SHL, LOOP_COUNT times.
;
    mov  ecx,LOOP_COUNT
L1:  push eax                ; save original EAX
    mov  ebx,eax
    shl  eax,5
    shl  ebx,2
    add  eax,ebx
    pop  eax                ; restore EAX
    loop L1
    ret
mult_by_shifting ENDP

mult_by_MUL PROC
;
; Multiplies EAX by 36 using MUL, LOOP_COUNT times.
;
    mov  ecx,LOOP_COUNT
L1:  push eax                ; save original EAX
    mov  ebx,36
    mul  ebx
    pop  eax                ; restore EAX
    loop L1
    ret
mult_by_MUL ENDP

```



The following code calls *mult\_by\_shifting* and displays the timing results. See the *Compare-Mult.asm* program from the book's Chapter 7 examples for the complete implementation:

```
.data
LOOP_COUNT = 0FFFFFFFFh
.data
intval DWORD 5
startTime DWORD ?
.code
call GetMseconds           ; get start time
mov  startTime,eax
mov  eax,intval            ; multiply now
call mult_by_shifting
call GetMseconds           ; get stop time
sub  eax,startTime
call WriteDec              ; display elapsed time
```

After calling *mult\_by\_MUL* in the same manner, the resulting timings on a legacy 4-GHz Pentium 4 showed that the SHL approach executed in 6.078 seconds and the MUL approach executed in 20.718 seconds. In other words, using MUL instruction was 241 percent slower. However, when running the same program on a more recent processor, the timings of both function calls were exactly the same. This example shows that Intel has managed to greatly optimize the MUL and IMUL instructions in recent processors.

### 7.3.4 DIV Instruction

In 32-bit mode, the DIV (unsigned divide) instruction performs 8-bit, 16-bit, and 32-bit unsigned integer division. The single register or memory operand is the divisor. The formats are

```
DIV reg/mem8
DIV reg/mem16
DIV reg/mem32
```

The following table shows the relationship between the dividend, divisor, quotient, and remainder:

Dividend	Divisor	Quotient	Remainder
AX	reg/mem8	AL	AH
DX:AX	reg/mem16	AX	DX
EDX:EAX	reg/mem32	EAX	EDX

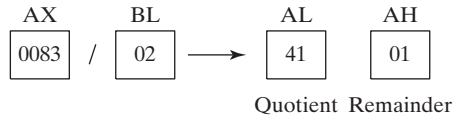
In 64-bit mode, the DIV instruction uses RDX:RAX as the dividend, and it permits the divisor to be a 64-bit register or memory operand. The quotient is stored in RAX, and the remainder in RDX.

#### ***DIV Examples***

The following instructions perform 8-bit unsigned division (83h/2), producing a quotient of 41h and a remainder of 1:

```
mov  ax,0083h           ; dividend
mov  bl,2               ; divisor
div  bl                 ; AL = 41h,  AH = 01h
```

The following diagram illustrates the movement between registers:



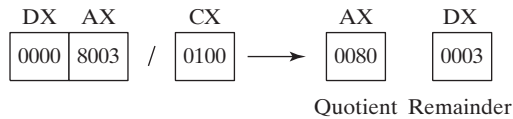
The following instructions perform 16-bit unsigned division (8003h/100h), producing a quotient of 80h and a remainder of 3. DX contains the high part of the dividend, so it must be cleared before the DIV instruction executes:

```

mov dx,0                ; clear dividend, high
mov ax,8003h            ; dividend, low
mov cx,100h             ; divisor
div cx                  ; AX = 0080h,  DX = 0003h

```

The following diagram illustrates the movement between registers:



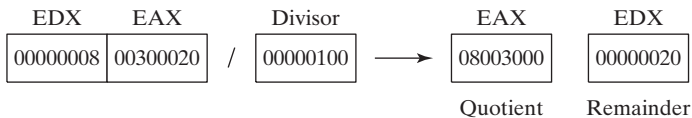
The following instructions perform 32-bit unsigned division using a memory operand as the divisor:

```

.data
dividend QWORD 0000000800300020h
divisor  DWORD 00000100h
.code
mov edx,DWORD PTR dividend + 4 ; high doubleword
mov eax,DWORD PTR dividend     ; low doubleword
div divisor                     ; EAX = 08003000h, EDX = 00000020h

```

The following diagram illustrates the movement between registers:



The following 64-bit division produces the quotient (0108000000003330h) in RAX and the remainder (0000000000000020h) in RDX:

```

.data
dividend_hi QWORD 0000000000000108h
dividend_lo QWORD 0000000033300020h
divisor     QWORD 0000000000010000h
.code
mov rdx, dividend_hi
mov rax, dividend_lo
div divisor                ; RAX = 0108000000003330
                          ; RDX = 0000000000000020

```

Notice how each hexadecimal digit in the dividend was shifted 4 positions to the right, because it was divided by 64. (Division by 16 would have moved each digit only one position to the right.)

### 7.3.5 Signed Integer Division

Signed integer division is nearly identical to unsigned division, with one important difference: The dividend must be sign-extended before the division takes place. *Sign extension* is the term used for copying the highest bit of a number into all of the upper bits of its enclosing variable or register. To show why this is necessary, let's try leaving it out. The following code uses MOV to assign  $-101$  to AX, which is the lower half of EAX:

```
.data
wordVal SWORD -101      ; 009Bh
.code
mov  eax,0              ; EAX = 00000000h
mov  ax,wordVal         ; EAX = 0000009Bh (+155)
mov  bx,2               ; EBX is the divisor
idiv bx                 ; divide EAX by BX (signed operation)
```

Unfortunately, the 009Bh in EAX is not really equal to  $-101$ . It is equal to  $+155$ , so the quotient produced by the division is  $+77$ , which is not what we wanted. Instead, the correct way to set up the problem is to use the CWD instruction (convert word to doubleword), which sign-extends AX into EAX before performing the division:

```
.data
wordVal SWORD -101      ; 009Bh
.code
mov  eax,0              ; EAX = 00000000h
mov  ax,wordVal         ; EAX = 0000009Bh (+155)
cwd  ; EAX = FFFFFFF9Bh (-101)
mov  bx,2               ; EBX is the divisor
idiv bx                 ; divide EAX by BX
```

We introduced the concept of sign extension in Chapter 4 along with the MOVSX instruction. The x86 instruction set includes several instructions for sign extension. First, we will look at these instructions, and then we will apply them to the signed integer division instruction, IDIV.

### Sign Extension Instructions (CBW, CWD, CDQ)

Intel provides three sign extension instructions: CBW, CWD, and CDQ. The CBW instruction (convert byte to word) extends the sign bit of AL into AH, preserving the number's sign. In the next example, 9Bh (in AL) and FF9Bh (in AX) both equal  $-101$  decimal:

```
.data
byteVal SBYTE -101      ; 9Bh
.code
mov  al,byteVal         ; AL = 9Bh
cbw  ; AX = FF9Bh
```

The CWD (convert word to doubleword) instruction extends the sign bit of AX into DX:

```
.data
wordVal SWORD -101          ; FF9Bh
.code
mov ax,wordVal              ; AX = FF9Bh
cwd                          ; DX:AX = FFFFFFF9Bh
```

The CDQ (convert doubleword to quadword) instruction extends the sign bit of EAX into EDX:

```
.data
dwordVal SDWORD -101       ; FFFFFFF9Bh
.code
mov eax,dwordVal
cdq                          ; EDX:EAX = FFFFFFFF9Bh
```

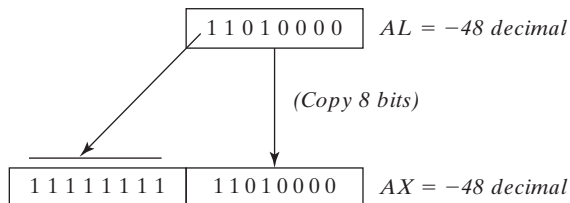
### The IDIV Instruction

The IDIV (signed divide) instruction performs signed integer division, using the same operands as DIV. Before executing 8-bit division, the dividend (AX) must be completely sign-extended. The remainder always has the same sign as the dividend.

**Example 1** The following instructions divide  $-48$  by  $5$ . After IDIV executes, the quotient in AL is  $-9$  and the remainder in AH is  $-3$ :

```
.data
byteVal SBYTE -48          ; D0 hexadecimal
.code
mov al,byteVal              ; lower half of dividend
cbw                          ; extend AL into AH
mov bl,+5                    ; divisor
idiv bl                      ; AL = -9, AH = -3
```

The following illustration shows how AL is sign-extended into AX by the CBW instruction:



To understand why sign extension of the dividend is necessary, let's repeat the previous example without using sign extension. The following code initializes AH to zero so it has a known value, and then divides without using CBW to prepare the dividend:

```
.data
byteVal SBYTE -48          ; D0 hexadecimal
.code
mov ah,0                    ; upper half of dividend
mov al,byteVal              ; lower half of dividend
mov bl,+5                    ; divisor
idiv bl                      ; AL = 41, AH = 3
```

Before the division, AX = 00D0h (208 decimal). IDIV divides this by 5, producing a quotient of 41 decimal, and a remainder of 3. That is certainly not the correct answer.

**Example 2** 16-Bit division requires AX to be sign-extended into DX. The next example divides  $-5000$  by 256:

```
.data
wordVal SWORD -5000
.code
mov ax,wordVal          ; dividend, low
cwd                     ; extend AX into DX
mov bx,+256             ; divisor
idiv bx                 ; quotient AX = -19, rem DX = -136
```

**Example 3** 32-Bit division requires EAX to be sign-extended into EDX. The next example divides 50,000 by  $-256$ :

```
.data
dwordVal SDWORD +50000
.code
mov eax,dwordVal        ; dividend, low
cdq                     ; extend EAX into EDX
mov ebx,-256            ; divisor
idiv ebx                 ; quotient EAX = -195, rem EDX = +80
```

All arithmetic status flag values are undefined after executing DIV and IDIV.

### Divide Overflow

If a division operand produces a quotient that will not fit into the destination operand, a *divide overflow* condition results. This causes a processor exception and halts the current program. The following instructions, for example, generate a divide overflow because the quotient (100h) is too large for the 8-bit AL destination register:

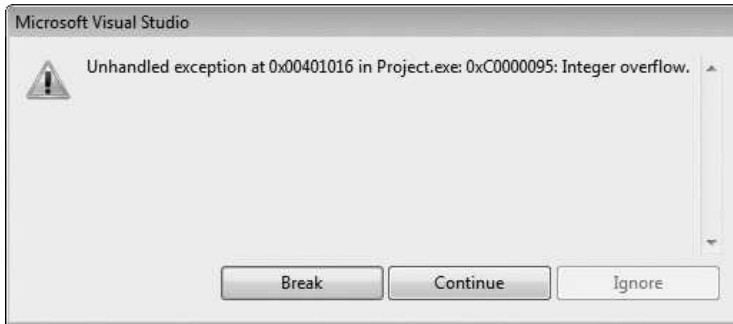
```
mov ax,1000h
mov bl,10h
div bl                  ; AL cannot hold 100h
```

When this code executes, Fig. 7-1 shows the resulting error dialog produced by Visual Studio. A similar dialog window appears when you execute code that attempts to divide by zero.

Here's a suggestion: use a 32-bit divisor and 64-bit dividend to reduce the probability of a divide overflow condition. In the following code, the divisor is EBX, and the dividend is placed in the 64-bit combined EDX and EAX registers:

```
mov eax,1000h
cdq
mov ebx,10h
div ebx                 ; EAX = 00000100h
```

FIGURE 7-1 Divide overflow error example.



To prevent division by zero, test the divisor before dividing:

```

mov ax,dividend
mov bl,divisor
cmp bl,0           ; check the divisor
je NoDivideZero   ; zero? display error
div bl            ; not zero: continue
.
.
NoDivideZero:     ;(display "Attempt to divide by zero")

```

### 7.3.6 Implementing Arithmetic Expressions

Chapter 4 showed how to implement arithmetic expressions using addition and subtraction. We can now include multiplication and division. Implementing arithmetic expressions at first seems to be an activity best left for compiler writers, but there is much to be gained by hands-on study. You can learn how compilers optimize code. Also, you can implement better error checking than a typical compiler by checking the size of the product following multiplication operations. Most high-level language compilers ignore the upper 32 bits of the product when multiplying two 32-bit operands. In assembly language, however, you can use the Carry and Overflow flags to tell you when the product does not fit into 32 bits. The use of these flags was explained in Sections 7.4.1 and 7.4.2.

**Tip:** There are two easy ways to view assembly code generated by a C++ compiler: While debugging in Visual Studio, right-click in the debug window and select *Go to Disassembly*. Alternatively, to generate a listing file, select *Properties* from the Project menu. Under *Configuration Properties*, select *Microsoft Macro Assembler*. Then select *Listing File*. In the dialog window, set *Generate Preprocessed Source Listing* to *Yes*, and set *List All Available Information* to *Yes*.

**Example 1** Implement the following C++ statement in assembly language, using unsigned 32-bit integers:

```
var4 = (var1 + var2) * var3;
```

This is a straightforward problem because we can work from left to right (addition, then multiplication). After the second instruction, EAX contains the sum of **var1** and **var2**. In the third instruction, EAX is multiplied by **var3** and the product is stored in EAX:

```

    mov  eax,var1
    add  eax,var2
    mul  var3                ; EAX = EAX * var3
    jc   tooBig             ; unsigned overflow?
    mov  var4,eax
    jmp  next
tooBig:                        ; display error message

```

If the MUL instruction generates a product larger than 32 bits, the JC instruction jumps to a label that handles the error.

*Example 2* Implement the following C++ statement, using unsigned 32-bit integers:

```
var4 = (var1 * 5) / (var2 - 3);
```

In this example, there are two subexpressions within parentheses. The left side can be assigned to EDX:EAX, so it is not necessary to check for overflow. The right side is assigned to EBX, and the final division completes the expression:

```

    mov  eax,var1           ; left side
    mov  ebx,5
    mul  ebx                ; EDX:EAX = product
    mov  ebx,var2          ; right side
    sub  ebx,3
    div  ebx                ; final division
    mov  var4,eax

```

*Example 3* Implement the following C++ statement, using signed 32-bit integers:

```
var4 = (var1 * -5) / (-var2 % var3);
```

This example is a little trickier than the previous ones. We can begin with the expression on the right side and store its value in EBX. Because the operands are signed, it is important to sign-extend the dividend into EDX and use the IDIV instruction:

```

    mov  eax,var2          ; begin right side
    neg  eax
    cdq                    ; sign-extend dividend
    idiv var3              ; EDX = remainder
    mov  ebx,edx           ; EBX = right side

```

Next, we calculate the expression on the left side, storing the product in EDX:EAX:

```

    mov  eax,-5            ; begin left side
    imul var1              ; EDX:EAX = left side

```

Finally, the left side (EDX:EAX) is divided by the right side (EBX):

```

    idiv ebx                ; final division
    mov  var4,eax          ; quotient

```

### 7.3.7 Section Review

1. Explain why overflow cannot occur when the MUL and one-operand IMUL instructions execute.
2. How is the one-operand IMUL instruction different from MUL in the way it generates a multiplication product?
3. What has to happen in order for the one-operand IMUL to set the Carry and Overflow flags?
4. When EBX is the operand in a DIV instruction, which register holds the quotient?
5. When BX is the operand in a DIV instruction, which register holds the quotient?
6. When BL is the operand in a MUL instruction, which registers hold the product?
7. Show an example of sign extension before calling the IDIV instruction with a 16-bit operand.

## 7.4 Extended Addition and Subtraction

*Extended precision addition and subtraction* is the technique of adding and subtracting numbers having an almost unlimited size. In C++, for example, no standard operator permits you to add two 1024-bit integers. But in assembly language, the ADC (add with carry) and SBB (subtract with borrow) instructions are well suited to this type of operation.

### 7.4.1 ADC Instruction

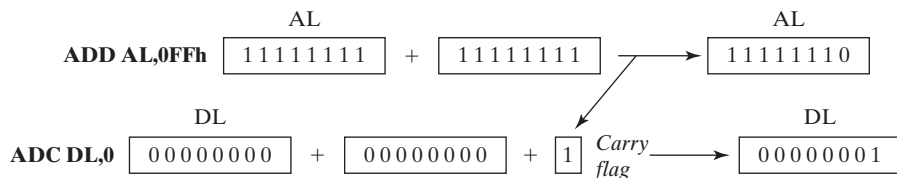
The ADC (add with carry) instruction adds both a source operand and the contents of the Carry flag to a destination operand. The instruction formats are the same as for the ADD instruction, and the operands must be the same size:

```
ADC reg, reg
ADC mem, reg
ADC reg, mem
ADC mem, imm
ADC reg, imm
```

For example, the following instructions add two 8-bit integers (FFh + FFh), producing a 16-bit sum in DL:AL, which is 01FEh:

```
mov dl, 0
mov al, 0FFh
add al, 0FFh           ; AL = FEh
adc dl, 0              ; DL/AL = 01FEh
```

The following illustration shows the movement of data during the two addition steps. First, FFh is added to AL, producing FEh in the AL register and setting the Carry flag. Next, both 0 and the contents of the Carry flag are added to the DL register:





Similarly, the following instructions add two 32-bit integers (FFFFFFFFh + FFFFFFFFh), producing a 64-bit sum in EDX:EAX: 00000001FFFFFFFFh:

```

mov  edx,0
mov  eax,0FFFFFFFFh
add  eax,0FFFFFFFFh
adc  edx,0

```

## 7.4.2 Extended Addition Example

Next, we would like to demonstrate a procedure named **Extended\_Add** that adds two extended integers of the same size. Using a loop, it works its way through the two extended integers as if they were parallel arrays. As it adds each matching pair of values in the arrays, it includes the value of the carry from the addition that was performed during the previous iteration of the loop. Our implementation assumes that the integers are stored as arrays of bytes, but the example could easily be modified to add arrays of doublewords.

The procedure receives two pointers in ESI and EDI that point to the integers to be added. The EBX register points to a buffer in which the bytes of the sum will be stored, with the precondition that this buffer must be one byte longer than the two integers. Also, the procedure receives the length of the longest integer in ECX. The numbers must be stored in little-endian order, with the lowest order byte at each array's starting offset. Here's the code, with line numbers added so we can discuss it in detail:

```

1:      ;-----
2:      Extended_Add PROC
3:      ;
4:      ; Calculates the sum of two extended integers stored
5:      ; as arrays of bytes.
6:      ; Receives: ESI and EDI point to the two integers,
7:      ;           EBX points to a variable that will hold the sum,
8:      ;           and ECX indicates the number of bytes to be added.
9:      ; Storage for the sum must be one byte longer than the
10:     ;   input operands.
11:     ; Returns: nothing
12:     ;-----
13:     pushad
14:     clc                               ; clear the Carry flag
15:
16:     L1: mov  al,[esi]                   ; get the first integer
17:         adc  al,[edi]                   ; add the second integer
18:         pushfd                          ; save the Carry flag
19:         mov  [ebx],al                   ; store partial sum
20:         add  esi,1                       ; advance all three pointers
21:         add  edi,1
22:         add  ebx,1
23:         popfd                          ; restore the Carry flag
24:         loop L1                         ; repeat the loop
25:
26:     mov  byte ptr [ebx],0               ; clear high byte of sum

```

```

27:      adc   byte ptr [ebx],0      ; add any leftover carry
28:      popad
29:      ret
30:      Extended_Add ENDP

```

When lines 16 and 17 add the first two low-order bytes, the addition might set the Carry flag. Therefore, it's important to save the Carry flag by pushing it on the stack on line 18, because we will need it when the loop repeats. Line 19 saves the first byte of the sum, and lines 20–22 advance all three pointers (for the two operands and the sum array). Line 23 restores the Carry flag, and line 24 continues the loop back to line 16. (The LOOP instruction never modifies the CPU status flags.) As the loop repeats, line 17 adds the next pair of bytes, and includes the value of the Carry flag. So if a Carry had been generated during the first pass through the loop, that Carry would be included during the second pass through the loop. The loop continues this way until all bytes have been added. Then, finally lines 26 and 27 look for any Carry that was generated when the two high-order bytes of the operand were added, and adds this Carry to the extra byte in the sum operand.

The following sample code calls **Extended\_Add**, passing it two 8-byte integers. We are careful to allocate an extra byte for the sum:

```

.data
op1 BYTE 34h,12h,98h,74h,06h,0A4h,0B2h,0A2h
op2 BYTE 02h,45h,23h,00h,00h,87h,10h,80h
sum  BYTE 9 dup(0)

.code
main PROC
    mov  esi,OFFSET op1          ; first operand
    mov  edi,OFFSET op2          ; second operand
    mov  ebx,OFFSET sum          ; sum operand
    mov  ecx,LENGTHOF op1        ; number of bytes
    call Extended_Add

; Display the sum.

    mov  esi,OFFSET sum
    mov  ecx,LENGTHOF sum
    call Display_Sum
    call Crlf

```

The following output is produced by the program. The addition produces a carry:

```
0122C32B0674BB5736
```

The **Display\_Sum** procedure (from the same program) displays the sum in its proper order, starting with the high-order byte, and working its way down to the low-order byte:

```

Display_Sum PROC
    pushad
    ; point to the last array element
    add  esi,ecx
    sub  esi,TYPE BYTE
    mov  ebx,TYPE BYTE

```

```

L1: mov  al,[esi]           ; get an array byte
    call WriteHexB        ; display it
    sub  esi,TYPE BYTE     ; point to previous byte
    loop L1

    popad
    ret
Display_Sum ENDP

```

### 7.4.3 SBB Instruction

The SBB (subtract with borrow) instruction subtracts both a source operand and the value of the Carry flag from a destination operand. The possible operands are the same as for the ADC instruction. The following example code carries out 64-bit subtraction with 32-bit operands. It sets EDX:EAX to 0000000700000001h and subtracts 2 from this value. The lower 32 bits are subtracted first, setting the Carry flag. Then the upper 32 bits are subtracted, including the Carry flag:

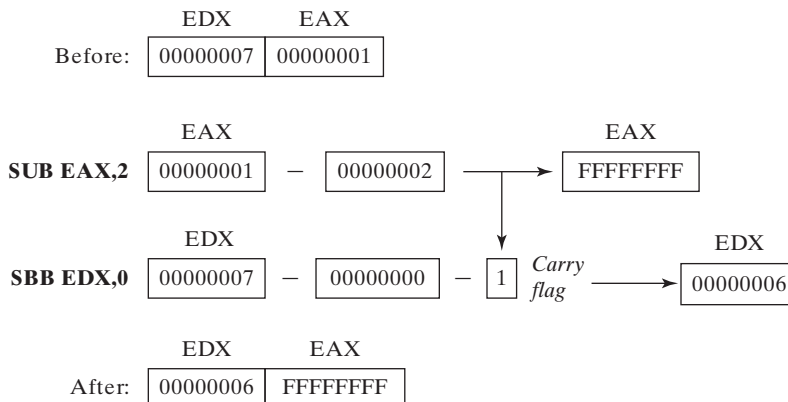
```

mov  edx,7                ; upper half
mov  eax,1                ; lower half
sub  eax,2                ; subtract 2
sbb  edx,0                ; subtract upper half

```

Figure 7-2 demonstrates the movement of data during the two subtraction steps. First, the value 2 is subtracted from EAX, producing FFFFFFFFh in EAX. The Carry flag is set because a borrow is required when subtracting a larger number from a smaller one. Next the SBB instruction subtracts both 0 and the contents of the Carry flag from EDX.

FIGURE 7-2 Subtracting from a 64-bit integer using SBB.



### 7.4.4 Section Review

1. Describe the ADC instruction.
2. Describe the SBB instruction.

3. What will be the values of EDX:EAX after the following instructions execute?

```
mov  edx,10h
mov  eax,0A0000000h
add  eax,20000000h
adc  edx,0
```

4. What will be the values of EDX:EAX after the following instructions execute?

```
mov  edx,100h
mov  eax,80000000h
sub  eax,90000000h
sbb  edx,0
```

5. What will be the contents of DX after the following instructions execute (STC sets the Carry flag)?

```
mov  dx,5
stc                                     ; set Carry flag
mov  ax,10h
adc  dx,ax
```

## 7.5 ASCII and Unpacked Decimal Arithmetic

(The instructions discussed in Section 7.5 apply only to programming in 32-bit mode.) The integer arithmetic shown so far in this book has dealt only with binary values. The CPU calculates in binary, but is also able to perform arithmetic on ASCII decimal strings. The latter can be conveniently entered by the user and displayed in the console window, without requiring them to be converted to binary. Suppose a program is to input two numbers from the user and add them together. The following is a sample of the output, in which the user has entered 3402 and 1256:

```
Enter first number:  3402
Enter second number: 1256
The sum is:         4658
```

We have two options when calculating and displaying the sum:

1. Convert both operands to binary, add the binary values, and convert the sum from binary to ASCII digit strings.
2. Add the digit strings directly by successively adding each pair of ASCII digits (2 + 6, 0 + 5, 4 + 2, and 3 + 1). The sum is an ASCII digit string, so it can be directly displayed on the screen.

The second option requires the use of specialized instructions that adjust the sum after adding each pair of ASCII digits. Four instructions that deal with ASCII addition, subtraction, multiplication, and division are as follows:

AAA	(ASCII adjust after addition)
AAS	(ASCII adjust after subtraction)
AAM	(ASCII adjust after multiplication)
AAD	(ASCII adjust before division)

**ASCII Decimal and Unpacked Decimal** The high 4 bits of an unpacked decimal integer are always zeros, whereas the same bits in an ASCII decimal number are equal to 0011b. In any case, both types of integers store one digit per byte. The following example shows how 3402 would be stored in both formats:



(All values are in hexadecimal)

Although ASCII arithmetic executes more slowly than binary arithmetic, it has two distinct advantages:

- Conversion from string format before performing arithmetic is not necessary.
- Using an assumed decimal point permits operations on real numbers without danger of the roundoff errors that occur with floating-point numbers.

ASCII addition and subtraction permit operands to be in ASCII format or unpacked decimal format. Only unpacked decimal numbers can be used for multiplication and division.

### 7.5.1 AAA Instruction

In 32-bit Mode, the AAA (ASCII adjust after addition) instruction adjusts the binary result of an ADD or ADC instruction. Assuming that AL contains a binary value produced by adding two ASCII digits, AAA converts AL to two unpacked decimal digits and stores them in AH and AL. Once in unpacked format, AH and AL can easily be converted to ASCII by ORing them with 30h.

The following example shows how to add the ASCII digits 8 and 2 correctly, using the AAA instruction. You must clear AH to zero before performing the addition or it will influence the result returned by AAA. The last instruction converts AH and AL to ASCII digits:

```

mov ah,0
mov al,'8'           ; AX = 0038h
add al,'2'          ; AX = 006Ah
aaa                 ; AX = 0100h (ASCII adjust result)
or ax,3030h        ; AX = 3130h = '10' (convert to ASCII)

```

### Multibyte Addition Using AAA

Let's look at a procedure that adds ASCII decimal values with implied decimal points. The implementation is a bit more complex than one would imagine because the carry from each digit addition must be propagated to the next highest position. In the following pseudocode, the name *acc* refers to an 8-bit accumulator register:

```

esi (index) = length of first_number - 1
edi (index) = length of first_number
ecx = length of first_number
set carry value to 0
Loop
    acc = first_number[esi]
    add previous carry to acc
    save carry in carry1
    acc += second_number[esi]

```

```

    OR the carry with carry1
    sum[edi] = acc
    dec edi
Until ecx == 0
Store last carry digit in sum

```

The carry digit must always be converted to ASCII. When you add the carry digit to the first operand, you must adjust the result with AAA. Here is the listing:

```

; ASCII Addition                                     (ASCII_add.asm)
; Perform ASCII arithmetic on strings having
; an implied fixed decimal point.

INCLUDE Irvine32.inc

DECIMAL_OFFSET = 5                                ; offset from right of string
.data
decimal_one BYTE "100123456789765"                ; 1001234567.89765
decimal_two BYTE "900402076502015"                ; 9004020765.02015
sum BYTE (SIZEOF decimal_one + 1) DUP(0),0

.code
main PROC
; Start at the last digit position.
    mov     esi,SIZEOF decimal_one - 1
    mov     edi,SIZEOF decimal_one
    mov     ecx,SIZEOF decimal_one
    mov     bh,0                                     ; set carry value to zero
L1: mov     ah,0                                     ; clear AH before addition
    mov     al,decimal_one[esi]                     ; get the first digit
    add     al,bh                                     ; add the previous carry
    aaa                                          ; adjust the sum (AH = carry)
    mov     bh,ah                                     ; save the carry in carry1
    or     bh,30h                                    ; convert it to ASCII
    add     al,decimal_two[esi]                     ; add the second digit
    aaa                                          ; adjust the sum (AH = carry)
    or     bh,ah                                     ; OR the carry with carry1
    or     bh,30h                                    ; convert it to ASCII
    or     al,30h                                    ; convert AL back to ASCII
    mov     sum[edi],al                             ; save it in the sum
    dec     esi                                     ; back up one digit
    dec     edi
    loop   L1
    mov     sum[edi],bh                             ; save last carry digit

; Display the sum as a string.
    mov     edx,OFFSET sum
    call   WriteString
    call   Crlf

    exit
main ENDP
END main

```

Here is the program's output, showing the sum without a decimal point:

1000525533291780

### 7.5.2 AAS Instruction

In 32-bit Mode, the AAS (ASCII adjust after subtraction) instruction follows a SUB or SBB instruction that has subtracted one unpacked decimal value from another and stored the result in AL. It makes the result in AL consistent with ASCII digit representation. Adjustment is necessary only when the subtraction generates a negative result. For example, the following statements subtract ASCII 9 from 8:

```
.data
val1 BYTE '8'
val2 BYTE '9'
.code
mov ah,0
mov al,val1                ; AX = 0038h
sub al,val2                ; AX = 00FFh
aas                        ; AX = FF09h
pushf                      ; save the Carry flag
or al,30h                  ; AX = FF39h
popf                       ; restore the Carry flag
```

After the SUB instruction, AX equals 00FFh. The AAS instruction converts AL to 09h and subtracts 1 from AH, setting it to FFh and setting the Carry flag.

### 7.5.3 AAM Instruction

In 32-bit Mode, the AAM (ASCII adjust after multiplication) instruction converts the binary product produced by MUL to unpacked decimal. The multiplication can only use unpacked decimals. In the following example, we multiply 5 by 6 and adjust the result in AX. After adjustment, AX = 0300h, the unpacked decimal representation of 30:

```
.data
AscVal BYTE 05h,06h
.code
mov bl,ascVal              ; first operand
mov al,[ascVal+1]         ; second operand
mul bl                     ; AX = 001Eh
aam                        ; AX = 0300h
```

### 7.5.4 AAD Instruction

In 32-Bit Mode, the AAD (ASCII adjust before division) instruction converts an unpacked decimal dividend in AX to binary in preparation for executing the DIV instruction. The following example converts unpacked 0307h to binary, then divides it by 5. DIV produces a quotient of 07h in AL and a remainder of 02h in AH:

```
.data
quotient BYTE ?
remainder BYTE ?
.code
```

```

mov ax,0307h           ; dividend
aad                   ; AX = 0025h
mov bl,5              ; divisor
div bl                ; AX = 0207h
mov quotient,al
mov remainder,ah

```

### 7.5.5 Section Review

1. Write a single instruction that converts a two-digit unpacked decimal integer in AX to ASCII decimal.
2. Write a single instruction that converts a two-digit ASCII decimal integer in AX to unpacked decimal format.
3. Write a two-instruction sequence that converts a two-digit ASCII decimal number in AX to binary.
4. Write a single instruction that converts an unsigned binary integer in AX to unpacked decimal.

## 7.6 Packed Decimal Arithmetic

(The instructions discussed in Section 7.6 apply only to programming in 32-bit mode.) Packed decimal integers store two decimal digits per byte. Each digit is represented by 4 bits. If there is an odd number of digits, the highest nybble is filled with a zero. Storage sizes may vary:

```

bcd1 QWORD 2345673928737285h ; 2,345,673,928,737,285 decimal
bcd2 DWORD 12345678h         ; 12,345,678 decimal
bcd3 DWORD 08723654h         ; 8,723,654 decimal
bcd4 WORD 9345h              ; 9,345 decimal
bcd5 WORD 0237h              ; 237 decimal
bcd6 BYTE 34h                ; 34 decimal

```

Packed decimal storage has at least two strengths:

- The numbers can have almost any number of significant digits. This makes it possible to perform calculations with a great deal of accuracy.
- Conversion of packed decimal numbers to ASCII (and vice versa) is relatively simple.

Two instructions, DAA (decimal adjust after addition) and DAS (decimal adjust after subtraction), adjust the result of an addition or subtraction operation on packed decimals. Unfortunately, no such instructions exist for multiplication and division. In those cases, the number must be unpacked, multiplied or divided, and repacked.

### 7.6.1 DAA Instruction

In 32-bit Mode, the DAA (decimal adjust after addition) instruction converts a binary sum produced by ADD or ADC in AL to packed decimal format. For example, the following instructions add packed decimals 35 and 48. The binary sum (7Dh) is adjusted to 83h, the packed decimal sum of 35 and 48.

```

mov al,35h
add al,48h             ; AL = 7Dh
daa                   ; AL = 83h (adjusted result)

```



The internal logic of DAA is documented in the Intel Instruction Set Reference Manual.

*Example* The following program adds two 16-bit packed decimal integers and stores the sum in a packed doubleword. Addition requires the sum variable to contain space for one more digit than the operands:

```

; Packed Decimal Example          (AddPacked.asm)
; Demonstrate packed decimal addition.
INCLUDE Irvine32.inc

.data
packed_1 WORD 4536h
packed_2 WORD 7207h
sum DWORD ?

.code
main PROC
; Initialize sum and index.
    mov     sum,0
    mov     esi,0

; Add low bytes.
    mov     al,BYTE PTR packed_1[esi]
    add     al,BYTE PTR packed_2[esi]
    daa
    mov     BYTE PTR sum[esi],al

; Add high bytes, include carry.
    inc     esi
    mov     al,BYTE PTR packed_1[esi]
    adc     al,BYTE PTR packed_2[esi]
    daa
    mov     BYTE PTR sum[esi],al

; Add final carry, if any.
    inc     esi
    mov     al,0
    adc     al,0
    mov     BYTE PTR sum[esi],al

; Display the sum in hexadecimal.
    mov     eax,sum
    call    WriteHex
    call    Crlf
    exit
main ENDP
END main

```

Needless to say, the program contains repetitive code that suggests using a loop. One of the chapter exercises will ask you to create a procedure that adds packed decimal integers of any size.

### 7.6.2 DAS Instruction

In 32-bit Mode, the DAS (decimal adjust after subtraction) instruction converts the binary result of a SUB or SBB instruction in AL to packed decimal format. For example, the following statements subtract packed decimal 48 from 85 and adjust the result:

```

mov  bl,48h
mov  al,85h
sub  al,bl           ; AL = 3Dh
das                    ; AL = 37h (adjusted result)

```

The internal logic of DAS is documented in the Intel Instruction Set Reference Manual.

### 7.6.3 Section Review

1. Under what circumstances does DAA instruction set the Carry flag? Give an example.
2. Under what circumstances does DAS instruction set the Carry flag? Give an example.
3. When adding two packed decimal integers of length  $n$  bytes, how many storage bytes must be reserved for the sum?

## 7.7 Chapter Summary

Along with the bitwise instructions from the preceding chapter, shift instructions are among the most characteristic of assembly language. To *shift* a number means to move its bits right or left.

The SHL (shift left) instruction shifts each bit in a destination operand to the left, filling the lowest bit with 0. One of the best uses of SHL is for performing high-speed multiplication by powers of 2. Shifting any operand left by  $n$  bits multiplies the operand by  $2^n$ . The SHR (shift right) instruction shifts each bit to the right, replacing the highest bit with a 0. Shifting any operand right by  $n$  bits divides the operand by  $2^n$ .

SAL (shift arithmetic left) and SAR (shift arithmetic right) are shift instructions specifically designed for shifting signed numbers.

The ROL (rotate left) instruction shifts each bit to the left and copies the highest bit to both the Carry flag and the lowest bit position. The ROR (rotate right) instruction shifts each bit to the right and copies the lowest bit to both the Carry flag and the highest bit position.

The RCL (rotate carry left) instruction shifts each bit to the left and copies the highest bit into the Carry flag, which is first copied into the lowest bit of the result. The RCR (rotate carry right) instruction shifts each bit to the right and copies the lowest bit into the Carry flag. The Carry flag is copied into the highest bit of the result.

The SHLD (shift left double) and SHRD (shift right double) instructions, available on x86 processors, are particularly effective for shifting bits in large integers.

In 32-bit mode, the MUL instruction multiplies an 8-, 16-, or 32-bit operand by AL, AX, or EAX. In 64-bit mode, a value can also be multiplied by the RAX register. The IMUL instruction performs signed integer multiplication. It has three formats: single operand, double operand, and three operand.

In 32-bit mode, the DIV instruction performs 8-bit, 16-bit, and 32-bit division on unsigned integers. In 64-bit mode, you can also perform 64-bit division. The IDIV instruction performs signed integer division, using the same operands as the DIV instruction.

The CBW (convert byte to word) instruction extends the sign bit of AL into the AH register. The CDQ (convert doubleword to quadword) instruction extends the sign bit of EAX into the EDX register. The CWD (convert word to doubleword) instruction extends the sign bit of AX into the DX register.

*Extended addition and subtraction* refers to adding and subtracting integers of arbitrary size. The ADC and SBB instructions can be used to implement such addition and subtraction. The ADC (add with carry) instruction adds both a source operand and the contents of the Carry flag to a destination operand. The SBB (subtract with borrow) instruction subtracts both a source operand and the value of the Carry flag from a destination operand.

*ASCII decimal* integers store one digit per byte, encoded as an ASCII digit. The AAA (ASCII adjust after addition) instruction converts the binary result of an ADD or ADC instruction to ASCII decimal. The AAS (ASCII adjust after subtraction) instruction converts the binary result of a SUB or SBB instruction to ASCII decimal. All of these instructions are available only in 32-bit mode.

*Unpacked decimal* integers store one decimal digit per byte, as a binary value. The AAM (ASCII adjust after multiplication) instruction converts the binary product of a MUL instruction to unpacked decimal. The AAD (ASCII adjust before division) instruction converts an unpacked decimal dividend to binary in preparation for the DIV instruction. All of these instructions are available only in 32-bit mode.

*Packed decimal* integers store two decimal digits per byte. The DAA (decimal adjust after addition) instruction converts the binary result of an ADD or ADC instruction to packed decimal. The DAS (decimal adjust after subtraction) instruction converts the binary result of a SUB or SBB instruction to packed decimal. All of these instructions are available only in 32-bit mode.

## 7.8 Key Terms

### 7.8.1 Terms

arithmetic shift	divide overflow
binary multiplication	little-endian order
bit rotation	logical shift
bit shifting	sign extension
bit strings	signed division
bitwise division	signed multiplication
bitwise multiplication	signed overflow
bitwise rotation	unsigned multiplication

### 7.8.2 Instructions, Operators, and Directives

AAA	AAS	CBW
AAD	ADC	DAA
AAM	CBQ	DAS

DIV	RCR	SBB
IDIV	ROL	SHL
IMUL	ROR	SHLD
MUL	SAL	SHR
RCL	SAR	SHRD

## 7.9 Review Questions and Exercises

### 7.9.1 Short Answer

1. In the following code sequence, show the value of AL after each shift or rotate instruction has executed:

```

mov al,0D4h
shr al,1           ; a.
mov al,0D4h
sar al,1           ; b.
mov al,0D4h
sar al,4           ; c.
mov al,0D4h
rol al,1           ; d.

```

2. In the following code sequence, show the value of AL after each shift or rotate instruction has executed:

```

mov al,0D4h
ror al,3           ; a.
mov al,0D4h
rol al,7           ; b.
stc
mov al,0D4h
rcl al,1           ; c.
stc
mov al,0D4h
rcr al,3           ; d.

```

3. What will be the contents of AX and DX after the following operation?

```

mov dx,0
mov ax,222h
mov cx,100h
mul cx

```

4. What will be the contents of AX after the following operation?

```

mov ax,63h
mov bl,10h
div bl

```

5. What will be the contents of EAX and EDX after the following operation?

```

mov eax,123400h
mov edx,0
mov ebx,10h
div ebx

```

6. What will be the contents of AX and DX after the following operation?

```
mov ax,4000h
mov dx,500h
mov bx,10h
div bx
```

7. What will be the contents of BX after the following instructions execute?

```
mov bx,5
stc
mov ax,60h
adc bx,ax
```

8. Describe the output when the following code executes in 64-bit mode:

```
.data
dividend_hi QWORD 00000108h
dividend_lo QWORD 33300020h
divisor     QWORD 00000100h
.code
mov rdx,dividend_hi
mov rax,dividend_lo
div divisor
```

9. The following program is supposed to subtract **val2** from **val1**. Find and correct all logic errors (CLC clears the Carry flag):

```
.data
val1 QWORD 20403004362047A1h
val2 QWORD 055210304A2630B2h
result QWORD 0

.code
mov cx,8 ; loop counter
mov esi,val1 ; set index to start
mov edi,val2
clc ; clear Carry flag
top:
mov al,BYTE PTR[esi] ; get first number
sbb al,BYTE PTR[edi] ; subtract second
mov BYTE PTR[esi],al ; store the result
dec esi
dec edi
loop top
```

10. What will be the hexadecimal contents of RAX after the following instructions execute in 64-bit mode?

```
.data
multiplicand QWORD 0001020304050000h
.code
imul rax,multiplicand, 4
```

## 7.9.2 Algorithm Workbench

1. Write a sequence of shift instructions that cause AX to be sign-extended into EAX. In other words, the sign bit of AX is copied into the upper 16 bits of EAX. Do not use the CWD instruction.

2. Suppose the instruction set contained no rotate instructions. Show how you would use SHR and a conditional jump instruction to rotate the contents of the AL register 1 bit to the right.
3. Write a logical shift instruction that multiplies the contents of EAX by 16.
4. Write a logical shift instruction that divides EBX by 4.
5. Write a single rotate instruction that exchanges the high and low halves of the DL register.
6. Write a single SHLD instruction that shifts the highest bit of the AX register into the lowest bit position of DX and shifts DX one bit to the left.
7. Write a sequence of instructions that shift three memory bytes to the right by 1 bit position. Use the following test data:

```
byteArray BYTE 81h,20h,33h
```

8. Write a sequence of instructions that shift three memory words to the left by 1 bit position. Use the following test data:
- ```
wordArray WORD 810Dh, 0C064h,93ABh
```
9. Write instructions that multiply  $-5$  by 3 and store the result in a 16-bit variable **val1**.
  10. Write instructions that divide  $-276$  by 10 and store the result in a 16-bit variable **val1**.
  11. Implement the following C++ expression in assembly language, using 32-bit unsigned operands:

```
val1 = (val2 * val3) / (val4 - 3)
```

12. Implement the following C++ expression in assembly language, using 32-bit signed operands:

```
val1 = (val2 / val3) * (val1 + val2)
```

13. Write a procedure that displays an unsigned 8-bit binary value in decimal format. Pass the binary value in AL. The input range is limited to 0 to 99, decimal. The only procedure you can call from the book's link library is WriteChar. The procedure should contain approximately eight instructions. Here is a sample call:

```
mov al,65 ; range limit: 0 to 99
call showDecimal8
```

14. *Challenge:* Suppose AX contains 0072h and the Auxiliary Carry flag is set as a result of adding two unknown ASCII decimal digits. Use the Intel 64 and IA-32 Instruction Set Reference to determine what output the AAA instruction would produce. Explain your answer.
15. *Challenge:* Using only SUB, MOV, and AND instructions, show how to calculate  $x = n \bmod y$ , assuming that you are given the values of  $n$  and  $y$ . You can assume that  $n$  is any 32-bit unsigned integer, and  $y$  is a power of 2.
16. *Challenge:* Using only SAR, ADD, and XOR instructions (but no conditional jumps), write code that calculates the absolute value of the signed integer in the EAX register. *Hints:* A number can be negated by adding  $-1$  to it and then forming its one's complement. Also, if you XOR an integer with all 1s, its 1s are reversed. On the other hand, if you XOR an integer with all zeros, the integer is unchanged.

## 7.10 Programming Exercises

### ★ 1. Display ASCII Decimal

Write a procedure named **WriteScaled** that outputs a decimal ASCII number with an implied decimal point. Suppose the following number were defined as follows, where `DECIMAL_OFFSET` indicates that the decimal point must be inserted five positions from the right side of the number:

```
DECIMAL_OFFSET = 5
.data
decimal_one BYTE "100123456789765"
```

`WriteScaled` would display the number like this:

```
1001234567.89765
```

When calling `WriteScaled`, pass the number's offset in `EDX`, the number length in `ECX`, and the decimal offset in `EBX`. Write a test program that passes three numbers of different sizes to the `WriteScaled` procedure.

### ★ 2. Extended Subtraction Procedure

Create a procedure named **Extended\_Sub** that subtracts two binary integers of arbitrary size. The storage size of the two integers must be the same, and their size must be a multiple of 32 bits. Write a test program that passes several pairs of integers, each at least 10 bytes long.

### ★★ 3. Packed Decimal Conversion

Write a procedure named **PackedToAsc** that converts a 4-byte packed decimal integer to a string of ASCII decimal digits. Pass the packed integer and the address of a buffer holding the ASCII digits to the procedure. Write a short test program that passes at least 5 packed decimal integers to your procedure.

### ★★ 4. Encryption Using Rotate Operations

Write a procedure that performs simple encryption by rotating each plaintext byte a varying number of positions in different directions. For example, in the following array that represents the encryption key, a negative value indicates a rotation to the left and a positive value indicates a rotation to the right. The integer in each position indicates the magnitude of the rotation:

```
key BYTE -2, 4, 1, 0, -3, 5, 2, -4, -4, 6
```

Your procedure should loop through a plaintext message and align the key to the first 10 bytes of the message. Rotate each plaintext byte by the amount indicated by its matching key array value. Then, align the key to the next 10 bytes of the message and repeat the process. Write a program that tests your encryption procedure by calling it twice, with different data sets.

### ★★★ 5. Prime Numbers

Write a program that generates all prime numbers between 2 and 1000, using the *Sieve of Eratosthenes* method. You can find many articles that describe the method for finding primes in this manner on the Internet. Display all the prime values.

**\*\*\* 6. Greatest Common Divisor (GCD)**

The greatest common divisor (GCD) of two integers is the largest integer that will evenly divide both integers. The GCD algorithm involves integer division in a loop, described by the following pseudocode:

```
int GCD(int x, int y)
{
    x = abs(x)           // absolute value
    y = abs(y)
    do {
        int n = x % y
        x = y
        y = n
    } while (y > 0)
    return x
}
```

Implement this function in assembly language and write a test program that calls the function several times, passing it different values. Display all results on the screen.

**\*\*\* 7. Bitwise Multiplication**

Write a procedure named **BitwiseMultiply** that multiplies any unsigned 32-bit integer by EAX, using only shifting and addition. Pass the integer to the procedure in the EBX register, and return the product in the EAX register. Write a short test program that calls the procedure and displays the product. (We will assume that the product is never larger than 32 bits.) This is a fairly challenging program to write. One possible approach is to use a loop to shift the multiplier to the right, keeping track of the number of shifts that occur before the Carry flag is set. The resulting shift count can then be applied to the SHL instruction, using the multiplicand as the destination operand. Then, the same process must be repeated until you find the last 1 bit in the multiplier.

**\*\*\* 8. Add Packed Integers**

Extend the **AddPacked** procedure from Section 7.6.1 so that it adds two packed decimal integers of arbitrary size (both lengths must be the same). Write a test program that passes **AddPacked** several pairs of integers: 4-byte, 8-byte, and 16-byte. We suggest that you use the following registers to pass information to the procedure:

```
ESI - pointer to the first number
EDI - pointer to the second number
EDX - pointer to the sum
ECX - number of bytes to add
```



---

# ADVANCED PROCEDURES

- 8.1 Introduction
- 8.2 Stack Frames
  - 8.2.1 Stack Parameters
  - 8.2.2 Disadvantages of Register Parameters
  - 8.2.3 Accessing Stack Parameters
  - 8.2.4 32-Bit Calling Conventions
  - 8.2.5 Local Variables
  - 8.2.6 Reference Parameters
  - 8.2.7 LEA Instruction
  - 8.2.8 ENTER and LEAVE Instructions
  - 8.2.9 LOCAL Directive
  - 8.2.10 The Microsoft x64 Calling Convention
  - 8.2.11 Section Review
- 8.3 Recursion
  - 8.3.1 Recursively Calculating a Sum
  - 8.3.2 Calculating a Factorial
  - 8.3.3 Section Review
- 8.4 INVOKE, ADDR, PROC, and PROTO
  - 8.4.1 INVOKE Directive
  - 8.4.2 ADDR Operator
  - 8.4.3 PROC Directive
  - 8.4.4 PROTO Directive
  - 8.4.5 Parameter Classifications
  - 8.4.6 Example: Exchanging Two Integers
  - 8.4.7 Debugging Tips
  - 8.4.8 WriteStackFrame Procedure
  - 8.4.9 Section Review
- 8.5 Creating Multimodule Programs
  - 8.5.1 Hiding and Exporting Procedure Names
  - 8.5.2 Calling External Procedures
  - 8.5.3 Using Variables and Symbols across Module Boundaries
  - 8.5.4 Example: ArraySum Program
  - 8.5.5 Creating the Modules Using Extern
  - 8.5.6 Creating the Modules Using INVOKE and PROTO
  - 8.5.7 Section Review
- 8.6 Advanced Use of Parameters (Optional Topic)
  - 8.6.1 Stack Affected by the USES Operator
  - 8.6.2 Passing 8-Bit and 16-Bit Arguments on the Stack
  - 8.6.3 Passing 64-Bit Arguments
  - 8.6.4 Non-Doubleword Local Variables
- 8.7 Java Bytecodes (Optional Topic)
  - 8.7.1 Java Virtual Machine
  - 8.7.2 Instruction Set
  - 8.7.3 Java Disassembly Examples
  - 8.7.4 Example: Conditional Branch
- 8.8 Chapter Summary
- 8.9 Key Terms
  - 8.9.1 Terms
  - 8.9.2 Instructions, Operators, and Directives
- 8.10 Review Questions and Exercises
  - 8.10.1 Short Answer
  - 8.10.2 Algorithm Workbench
- 8.11 Programming Exercises

## 8.1 Introduction

This chapter introduces the underlying structure of subroutine calls, focusing on the runtime stack. The information in this chapter is valuable to C and C++ programmers, who frequently must inspect the contents of the runtime stack when debugging low-level routines that function at the operating system or device driver level.

Most modern languages push arguments on the stack before calling subroutines. The subroutines, in turn, usually store their local variables on the stack. The details you learn in this chapter are relevant to your studies of languages like C++ and Java. We will show how arguments are passed by value and by reference, how local variables are created and destroyed, and how recursion is implemented. At the end of the chapter, we will explain the different memory models and language specifiers used by MASM. Parameters can be passed both in registers and on the stack. This is the case in 64-bit mode, where Microsoft established the *Microsoft x64 calling convention*.

Programming languages use different terms to refer to subroutines. In C and C++, for example, subroutines are called *functions*. In Java, subroutines are called *methods*. In MASM, subroutines are called *procedures*. Our purpose in this chapter is to show low-level implementations of typical subroutine calls as they might appear in C and C++. At the beginning of this chapter, when referring to general principles, we will use the general term *subroutine*. When referring to specific assembly language code examples, we will frequently use the term *procedure* when referring to a subroutine.

Values passed to a subroutine by a calling program are called *arguments*. When the values are received by the called subroutine, they are called *parameters*.

## 8.2 Stack Frames

### 8.2.1 Stack Parameters

In earlier chapters, our subroutines received register parameters. This is true in the Irvine32 library, for example. In this chapter, we will show how subroutines can receive parameters on the runtime stack. In 32-bit mode, stack parameters are always used by Windows API functions. In 64-bit mode, however, Windows functions receive a combination of register parameters and stack parameters.

A *stack frame* (or *activation record*) is the area of the stack set aside for passed arguments, subroutine return address, local variables, and saved registers. The stack frame is created by the following sequential steps:

1. Passed arguments, if any, are pushed on the stack.
2. The subroutine is called, causing the subroutine return address to be pushed on the stack.
3. As the subroutine begins to execute, EBP is pushed on the stack.
4. EBP is set equal to ESP. From this point on, EBP acts as a base reference for all of the subroutine parameters.
5. If there are local variables, ESP is decremented to reserve space for the variables on the stack.
6. If any registers need to be saved, they are pushed on the stack.

The structure of a stack frame is directly affected by a program's memory model and its choice of argument passing convention.

There's a good reason to learn about passing arguments on the stack; nearly all high-level languages use them. If you want to call functions in the 32-bit Windows Application Programmer Interface (API), for example, you must pass arguments on the stack. On the other hand, 64-bit programs use a different parameter passing convention, which we will discuss in Chapter 11.

### 8.2.2 Disadvantages of Register Parameters

For a number of years, Microsoft has included a parameter passing convention in 32-bit programs named *fastcall*. As the name implies, there is some runtime efficiency to be had by simply placing parameters in registers before calling a subroutine. The alternative, which involves pushing parameters on the stack, executes more slowly. The registers used for parameters typically include EAX, EBX, ECX, and EDX, and less commonly, EDI and ESI. Unfortunately, these same registers are used to hold data values such as loop counters and operands in calculations. Therefore, any registers used as parameters must first be pushed on the stack before procedure calls, assigned the values of procedure arguments, and later restored to their original values after the procedure returns. For example, this is the case when calling **DumpMem** from the Irvine32 library:

```

push ebx                ; save register values
push ecx
push esi
mov esi,OFFSET array   ; starting OFFSET
mov ecx,LENGTHOF array ; size, in units
mov ebx,TYPE array     ; doubleword format
call DumpMem           ; display memory
pop esi                ; restore register values
pop ecx
pop ebx

```

Not only do all the extra pushes and pops create code clutter, they tend to eliminate the very performance advantage we hoped to gain by avoiding register parameters! Also, programmers have to be very careful that each register's PUSH is matched by its appropriate POP, even when there exist multiple execution pathways through the code. In the following code, for example, if EAX equals 1 on line 8, the procedure will not return to its caller on line 17 because three register values were left on the runtime stack.

```

1: push ebx            ; save register values
2: push ecx
3: push esi
4: mov esi,OFFSET array ; starting OFFSET
5: mov ecx,LENGTHOF array ; size, in units
6: mov ebx,TYPE array   ; doubleword format
7: call DumpMem        ; display memory
8: cmp eax,1           ; error flag set?

```

```

    9: je     error_exit           ; exit with flag set
   10:
   11: pop    esi                   ; restore register values
   12: pop    ecx
   13: pop    ebx
   14: ret
   15: error_exit:
   16: mov    edx,offset error_msg
   17: ret

```

You may agree that a bug such as this is not easy to spot unless you spend a considerable amount of time staring at the code.

Stack parameters offer a flexible approach that does not require register parameters. Just before a subroutine call, the arguments are pushed on the stack. For example, if **DumpMem** used stack parameters, we would call it using the following code:

```

push  TYPE array
push  LENGTHOF array
push  OFFSET array
call  DumpMem

```

Two general types of arguments are pushed on the stack during subroutine calls:

- Value arguments (values of variables and constants)
- Reference arguments (addresses of variables)

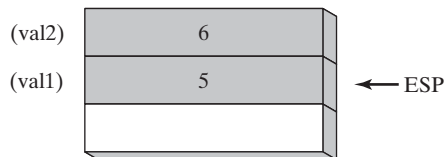
*Passing by Value* When an argument is passed *by value*, a copy of the value is pushed on the stack. Suppose we call a subroutine named **AddTwo**, passing it two 32-bit integers:

```

.data
val1  DWORD 5
val2  DWORD 6
.code
push  val2
push  val1
call  AddTwo

```

Following is a picture of the stack just prior to the CALL instruction:



An equivalent function call written in C++ would be

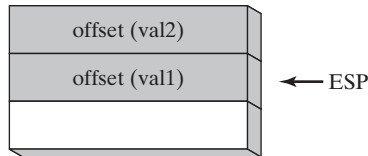
```
int sum = AddTwo( val1, val2 );
```

Observe that the arguments are pushed on the stack in reverse order, which is the norm for the C and C++ languages.

*Passing by Reference* An argument passed by reference consists of the address (offset) of an object. The following statements call **Swap**, passing the two arguments by reference:

```
push  OFFSET val2
push  OFFSET val1
call  Swap
```

Following is a picture of the stack just prior to the call to **Swap**:



The equivalent function call in C/C++ would pass the addresses of the `val1` and `val2` arguments:

```
Swap( &val1, &val2 );
```

*Passing Arrays* High-level languages always pass arrays to subroutines by reference. That is, they push the address of an array on the stack. The subroutine can then get the address from the stack and use it to access the array. It's easy to see why one would not want to pass an array by value, because doing so would require each array element to be pushed on the stack separately. Such an operation would be very slow, and it would use up precious stack space. The following statements do it the right way by passing the offset of array to a subroutine named **ArrayFill**:

```
.data
array  DWORD 50 DUP(?)
.code
push  OFFSET array
call  ArrayFill
```

### 8.2.3 Accessing Stack Parameters

High-level languages have various ways of initializing and accessing parameters during function calls. We will use the C and C++ languages as an example. They begin with a *prologue* consisting of statements that save the EBP register and point EBP to the top of the stack. Optionally, they may push certain registers on the stack whose values will be restored when the function returns. The end of the function consists of an *epilogue* in which the EBP register is restored and the RET instruction returns to the caller.

*AddTwo Example* The following **AddTwo** function, written in C, receives two integers passed by value and returns their sum:

```
int AddTwo( int x, int y )
{
    return x + y;
}
```

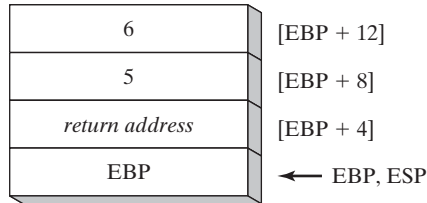
Let's create an equivalent implementation in assembly language. In its prologue, **AddTwo** pushes EBP on the stack to preserve its existing value:

```
AddTwo PROC
    push  ebp
```

Next, EBP is set to the same value as ESP, so EBP can be the base pointer for AddTwo's stack frame:

```
AddTwo PROC
    push ebp
    mov  ebp,esp
```

After the two instructions execute, the following figure shows the contents of the stack frame. A function call such as AddTwo(5, 6) would cause the second parameter to be pushed on the stack, followed by the first parameter:



AddTwo could push additional registers on the stack without altering the offsets of the stack parameters from EBP. ESP would change value, but EBP would not.

**Base-Offset Addressing** We will use base-offset addressing to access stack parameters. EBP is the base register and the offset is a constant. 32-bit values are usually returned in EAX. The following implementation of AddTwo adds the parameters and returns their sum in EAX:

```
AddTwo PROC
    push ebp
    mov  ebp,esp                ; base of stack frame
    mov  eax,[ebp + 12]        ; second parameter
    add  eax,[ebp + 8]         ; first parameter
    pop  ebp
    ret
AddTwo ENDP
```

### Explicit Stack Parameters

When stack parameters are referenced with expressions such as [ebp + 8], we call them *explicit stack parameters*. The reason for this term is that the assembly code explicitly states the offset of the parameter as a constant value. Some programmers define symbolic constants to represent the explicit stack parameters, to make their code easier to read:

```
y_param EQU [ebp + 12]
x_param EQU [ebp + 8]

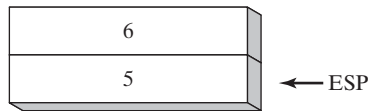
AddTwo PROC
    push ebp
    mov  ebp,esp
    mov  eax,y_param
    add  eax,x_param
    pop  ebp
    ret
AddTwo ENDP
```

### ***Cleaning Up the Stack***

There must be a way for parameters to be removed from the stack when a subroutine returns. Otherwise, a memory leak would result, and the stack would become corrupted. For example, suppose the following statements in **main** call **AddTwo**:

```
push 6
push 5
call AddTwo
```

Assuming that **AddTwo** leaves the two parameters on the stack, the following illustration shows the stack after returning from the call:

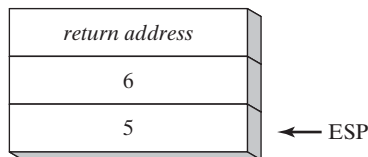


Inside **main**, we might try to ignore the problem and hope that the program terminates normally. But if we were to call **AddTwo** from a loop, the stack could overflow. Each call uses 12 bytes of stack space—4 bytes for each parameter, plus 4 bytes for the **CALL** instruction's return address. A more serious problem could result if we called **Example1** from **main**, which in turn calls **AddTwo**:

```
main PROC
    call Example1
    exit
main ENDP

Example1 PROC
    push 6
    push 5
    call AddTwo
    ret                                ; stack is corrupted!
Example1 ENDP
```

When the **RET** instruction in **Example1** is about to execute, **ESP** points to the integer 5 rather than the return address that would take it back to **main**:



The **RET** instruction loads the value 5 into the instruction pointer and attempts to transfer control to memory address 5. Assuming that this address is outside the program's code boundary, the processor issues a runtime exception, which tells the OS to terminate the program.

### 8.2.4 32-Bit Calling Conventions

In this section, we present the two most commonly used calling conventions for 32-bit programming in a Windows environment. First, the *C calling convention* was established by the C programming language, the language used to create both Unix and Windows. The *STDCALL calling convention* describes the protocol for calling Windows API functions. Both are important, since you may find yourself calling assembly functions from C and C++ programs, and your assembly language programs will also likely call numerous Windows API functions.

*The C Calling Convention* The C calling convention is used by the C and C++ programming languages. Subroutine parameters are pushed on the stack in reverse order, so a C program making a function call such as this will first push B on the stack, and then push A:

```
AddTwo( A, B )
```

The C calling convention solves the problem of cleaning up the runtime stack in a simple way: When a program calls a subroutine, it follows the CALL instruction with a statement that adds a value to the stack pointer (ESP) equal to the combined sizes of the subroutine parameters. Here is an example in which two arguments (5 and 6) are pushed on the stack before executing a CALL instruction:

```
Example1 PROC
    push 6
    push 5
    call AddTwo
    add esp,8           ; remove arguments from the stack
    ret
Example1 ENDP
```

Therefore, programs written in C/C++ always remove arguments from the stack in the calling program after a subroutine has returned.

*STDCALL Calling Convention* Another common way to remove parameters from the stack is to use a convention named STDCALL. In the following AddTwo procedure, we supply an integer parameter to the RET instruction, which in turn adds 8 to ESP after returning to the calling procedure. The integer must equal the number of bytes of stack space consumed by the procedure's parameters:

```
AddTwo PROC
    push ebp
    mov  ebp,esp       ; base of stack frame
    mov  eax,[ebp + 12] ; second parameter
    add  eax,[ebp + 8]  ; first parameter
    pop  ebp
    ret  8             ; clean up the stack
AddTwo ENDP
```

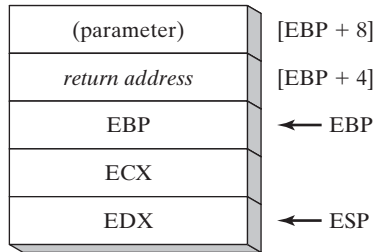
It should be pointed out that STDCALL, like C, pushes arguments onto the stack in reverse order. By having a parameter in the RET instruction, STDCALL reduces the amount of code





After it is initialized, EBP's contents remain fixed throughout the procedure. Pushing ECX and EDX does not affect the displacement from EBP of parameters already on the stack because the stack grows below EBP (see Fig. 8-1).

FIGURE 8-1 Stack frame for the MySub procedure.



### 8.2.5 Local Variables

In high-level languages, variables created, used, and destroyed within a single subroutine are called *local variables*. Local variables are created on the runtime stack, usually below the base pointer (EBP). Although they cannot be assigned default values at assembly time, they can be initialized at runtime. We can create local variables in assembly language by using the same techniques as C and C++.

**Example** The following C++ function declares local variables X and Y:

```
void MySub()
{
    int x = 10;
    int y = 20;
}
```

If this code were compiled into machine language, we would see how local variables are allocated. Each stack entry defaults to 32 bits, so each variable's storage size is rounded upward to a multiple of 4. A total of 8 bytes is reserved for the two local variables:

| Variable | Bytes | Stack Offset |
|----------|-------|--------------|
| X        | 4     | EBP - 4      |
| Y        | 4     | EBP - 8      |

The following disassembly (shown by a debugger) of the MySub function shows how a C++ program creates local variables, assigns values, and removes the variables from the stack. It uses the C calling convention:

```
MySub PROC
    push    ebp
    mov     ebp,esp
    sub     esp,8                ; create locals
```

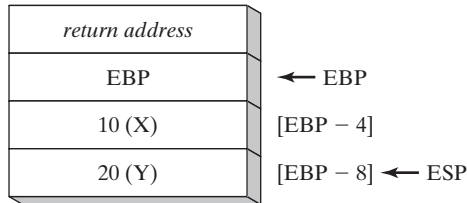
```

    mov  DWORD PTR [ebp-4],10    ; X
    mov  DWORD PTR [ebp-8],20   ; Y
    mov  esp,ebp                ; remove locals from stack
    pop  ebp
    ret
MySub ENDP

```

Figure 8-2 shows the function's stack frame after the local variables are initialized.

FIGURE 8-2 Stack frame after creating local variables.



Before finishing, the function resets the stack pointer by assigning it the value of EBP. The effect is to release the local variables from the stack:

```

    mov  esp,ebp                ; remove locals from stack

```

If this step is omitted, the POP EBP instruction would set EBP to 20 and the RET instruction would branch to memory location 10, causing the program to halt with a processor exception. Such is the case in the following version of MySub:

```

MySub PROC
    push ebp
    mov  ebp,esp
    sub  esp,8                  ; create locals
    mov  DWORD PTR [ebp-4],10   ; X
    mov  DWORD PTR [ebp-8],20   ; Y
    pop  ebp
    ret                          ; return to invalid address!
MySub ENDP

```

**Local Variable Symbols** In the interest of making programs easier to read, you can define a symbol for each local variable's offset and use the symbol in your code:

```

X_local EQU DWORD PTR [ebp-4]
Y_local EQU DWORD PTR [ebp-8]

MySub PROC
    push ebp
    mov  ebp,esp
    sub  esp,8                  ; reserve space for locals
    mov  X_local,10             ; X
    mov  Y_local,20             ; Y
    mov  esp,ebp                ; remove locals from stack
    pop  ebp
    ret
MySub ENDP

```

### 8.2.6 Reference Parameters

Reference parameters are usually accessed by procedures using base-offset addressing (from EBP). Because each reference parameter is a pointer, it is usually loaded into a register for use as an indirect operand. Suppose, for example, that a pointer to an array is located at stack address [ebp+12]. The following statement copies the pointer into ESI:

```
mov esi,[ebp+12]           ; points to the array
```

*ArrayFill Example* The **ArrayFill** procedure, which we are about to show, fills an array with a pseudorandom sequence of 16-bit integers. It receives two arguments: a pointer to the array and the array length. The first is passed by reference and the second is passed by value. Here is a sample call:

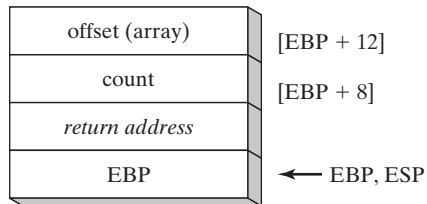
```
.data
count = 100
array WORD count DUP(?)

.code
push  OFFSET array
push  count
call  ArrayFill
```

Inside **ArrayFill**, the following prologue code initializes the stack frame pointer (EBP):

```
ArrayFill PROC
    push  ebp
    mov   ebp,esp
```

Now the stack frame contains the array offset, count, return address, and saved EBP:



**ArrayFill** saves the general-purpose registers, retrieves the parameters, and fills the array:

```
ArrayFill PROC
    push  ebp
    mov   ebp,esp
    pushad                ; save registers
    mov   esi,[ebp+12]    ; offset of array
    mov   ecx,[ebp+8]    ; array length
    cmp   ecx,0           ; ECX == 0?
    je    L2              ; yes: skip over loop
L1:
    mov   eax,10000h      ; get random 0 - FFFFh
    call  RandomRange    ; from the link library
    mov   [esi],ax       ; insert value in array
```

```

        add  esi,TYPE WORD      ; move to next element
        loop L1
L2:  popad                      ; restore registers
        pop  ebp
        ret   8                 ; clean up the stack
ArrayFill ENDP

```

### 8.2.7 LEA Instruction

The LEA instruction returns the address of an indirect operand. Because indirect operands contain one or more registers, their offsets are calculated at runtime. To show how LEA can be used, let's look at the following C++ program, which declares a local array of char and references **myString** when assigning values:

```

void makeArray( )
{
    char myString[30];
    for( int i = 0; i < 30; i++ )
        myString[i] = '*';
}

```

The equivalent code in assembly language allocates space for myString on the stack and assigns the address to ESI, an indirect operand. Although the array is only 30 bytes, ESP is decremented by 32 to keep it aligned on a doubleword boundary. Note how LEA is used to assign the array's address to ESI:

```

makeArray PROC
    push  ebp
    mov   ebp,esp
    sub   esp,32                ; myString is at EBP-30
    lea   esi,[ebp-30]         ; load address of myString
    mov   ecx,30               ; loop counter
L1:  mov   BYTE PTR [esi], '*'  ; fill one position
    inc   esi                  ; move to next
    loop  L1                   ; continue until ECX = 0
    add   esp,32               ; remove the array (restore ESP)
    pop   ebp
    ret
makeArray ENDP

```

It is not possible to use OFFSET to get the address of a stack parameter because OFFSET only works with addresses known at compile time. The following statement would not assemble:

```

mov   esi,OFFSET [ebp-30]      ; error

```

### 8.2.8 ENTER and LEAVE Instructions

The ENTER instruction automatically creates a stack frame for a called procedure. It reserves stack space for local variables and saves EBP on the stack. Specifically, it performs three actions:

- Pushes EBP on the stack (*push ebp*)
- Sets EBP to the base of the stack frame (*mov ebp, esp*)
- Reserves space for local variables (*sub esp,numbytes*)

ENTER has two operands: The first is a constant specifying the number of bytes of stack space to reserve for local variables and the second specifies the lexical nesting level of the procedure.

```
ENTER numbytes, nestinglevel
```

Both operands are immediate values. *Numbytes* is always rounded up to a multiple of 4 to keep ESP on a doubleword boundary. *Nestinglevel* determines the number of stack frame pointers copied into the current stack frame from the stack frame of the calling procedure. In our programs, *nestinglevel* is always zero. The Intel manuals explain how the ENTER instruction supports nesting levels in block-structured languages.

**Example 1** The following example declares a procedure with no local variables:

```
MySub PROC
    enter 0,0
```

It is equivalent to the following instructions:

```
MySub PROC
    push ebp
    mov  ebp,esp
```

**Example 2** The ENTER instruction reserves 8 bytes of stack space for local variables:

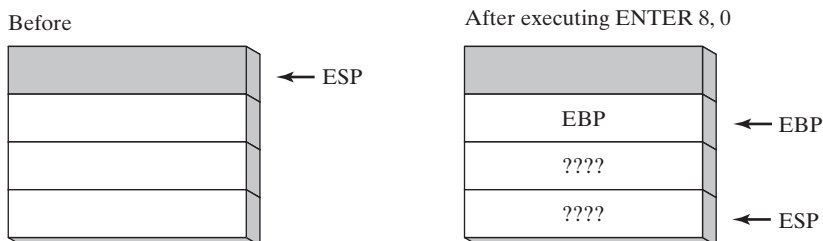
```
MySub PROC
    enter 8,0
```

It is equivalent to the following instructions:

```
MySub PROC
    push ebp
    mov  ebp,esp
    sub  esp,8
```

Figure 8-3 shows the stack before and after ENTER has executed.

FIGURE 8-3 Stack frame before and after ENTER has executed.



If you use the ENTER instruction, it is strongly advised that you also use the LEAVE instruction at the end of the same procedure. Otherwise, the stack space you create for local variables might not be released. This would cause the RET instruction to pop the wrong return address off the stack.

**LEAVE Instruction** The LEAVE instruction terminates the stack frame for a procedure. It reverses the action of a previous ENTER instruction by restoring ESP and EBP to the values

they were assigned when the procedure was called. Using the **MySub** procedure example again, we can write the following:

```
MySub PROC
    enter 8,0
    .
    .
    leave
    ret
MySub ENDP
```

The following equivalent set of instructions reserves and discards 8 bytes of space for local variables:

```
MySub PROC
    push ebp
    mov  ebp,esp
    sub  esp,8
    .
    .
    mov  esp,ebp
    pop  ebp
    ret
MySub ENDP
```

### 8.2.9 LOCAL Directive

We can guess that Microsoft created the LOCAL directive as a high-level substitute for the ENTER instruction. LOCAL declares one or more local variables by name, assigning them size attributes. (ENTER, on the other hand, only reserves a single unnamed block of stack space for local variables.) If used, LOCAL must appear on the line immediately following the PROC directive. Its syntax is

```
LOCAL varlist
```

*varlist* is a list of variable definitions, separated by commas, optionally spanning multiple lines. Each variable definition takes the following form:

```
label:type
```

The label may be any valid identifier, and type can either be a standard type (WORD, DWORD, etc.) or a user-defined type. (Structures and other user-defined types are described in Chapter 10.)

**Examples** The **MySub** procedure contains a local variable named **var1** of type BYTE:

```
MySub PROC
    LOCAL var1:BYTE
```

The **BubbleSort** procedure contains a doubleword local variable named **temp** and a variable named **SwapFlag** of type BYTE:

```
BubbleSort PROC
    LOCAL temp:DWORD, SwapFlag:BYTE
```

The **Merge** procedure contains a PTR WORD local variable named **pArray**, which is a pointer to a 16-bit integer:

```
Merge PROC
    LOCAL pArray:PTR WORD
```

The local variable **TempArray** is an array of 10 doublewords. Note the use of brackets to show the array size:

```
LOCAL TempArray[10]:DWORD
```

### MASM Code Generation

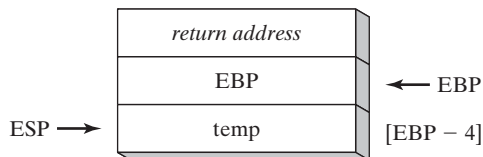
It's a good idea to look at the code generated by MASM when the LOCAL directive is used. The following **Example1** procedure has a single doubleword local variable:

```
Example1 PROC
    LOCAL temp:DWORD
    mov  eax,temp
    ret
Example1 ENDP
```

MASM generates the following code for Example1, showing how ESP is decremented by 4 to leave space for the doubleword variable:

```
push  ebp
mov   ebp,esp
add   esp,0FFFFFFFCh      ; add -4 to ESP
mov   eax,[ebp-4]
leave
ret
```

Here is a diagram of Example1's stack frame:



#### 8.2.10 The Microsoft x64 Calling Convention

Microsoft follows a consistent scheme for passing parameters and calling subroutines in 64-bit programs, known as the *Microsoft x64 calling convention*. This convention is used by C and C++ compilers, as well as by the Windows API library. The only time you need to use this calling convention is when you either call a Windows function, or you call a function written in C or C++. Here are the characteristics and requirements of this calling convention:

1. The CALL instruction subtracts 8 from the RSP (stack pointer) register, since addresses are 64 bits long.
2. The first four parameters passed to a subroutine are placed in the RCX, RDX, R8, and R9, registers, in that order. So if only one parameter is passed, it will be placed in RCX. If there



is a second parameter, it will be placed in RDX, and so on. Additional parameters are pushed on the stack, in left-to-right order.

- Parameters less than 64 bits long are not zero extended, so the upper bits have indeterminate values.
- If the return value is an integer whose size is less than or equal to 64 bits, it must be returned in the RAX register.
- It is the caller's responsibility to allocate at least 32 bytes of shadow space on the runtime stack, so called subroutines can optionally save the register parameters in this area.
- When calling a subroutine, the stack pointer (RSP) must be aligned on a 16-byte boundary. The CALL instruction pushes an 8-byte return address on the stack, so the calling program must subtract 8 from the stack pointer, in addition to the 32 it subtracts for the register parameters.
- It is the calling program's responsibility to remove all parameters and shadow space from the runtime stack after the called subroutine has finished.
- A return value larger than 64 bits is placed on the runtime stack, and RCX points to its location.
- The RAX, RCX, RDX, R8, R9, R10, and R11 registers are often altered by subroutines, so if the calling program wants them preserved, it will push them on the stack before the subroutine call, and pop them off the stack afterwards.
- The values of the RBX, RBP, RDI, RSI, R12, R14, R14, and R15 registers must be preserved by subroutines.

### 8.2.11 Section Review

- (True/False): A subroutine's stack frame always contains the caller's return address and the subroutine's local variables.
- (True/False): Arrays are passed by reference to avoid copying them onto the stack.
- (True/False): A subroutine's prologue code always pushes EBP on the stack.
- (True/False): Local variables are created by adding a positive value to the stack pointer.
- (True/False): In 32-bit mode, the last argument to be pushed on the stack in a subroutine call is stored at location EBP + 8.
- (True/False): Passing by reference means that an argument's address is stored on the runtime stack.
- What are the two common types of stack parameters?

## 8.3 Recursion

A *recursive subroutine* is one that calls itself, either directly or indirectly. *Recursion*, the practice of calling recursive subroutines, can be a powerful tool when working with data structures that have repeating patterns. Examples are linked lists and various types of connected graphs where a program must retrace its path.

*Endless Recursion* The most obvious type of recursion occurs when a subroutine calls itself. The following program, for example, has a procedure named **Endless** that calls itself repeatedly without ever stopping:

```

; Endless Recursion                (Endless.asm)
INCLUDE Irvine32.inc
.data
endlessStr BYTE "This recursion never stops",0
.code
main PROC
    call Endless
    exit
main ENDP

Endless PROC
    mov  edx,OFFSET endlessStr
    call WriteString
    call Endless
    ret                ; never executes
Endless ENDP
END main

```

Of course, this example doesn't have any practical value. Each time the procedure calls itself, it uses up 4 bytes of stack space when the CALL instruction pushes the return address. The RET instruction is never executed, and the program halts when the stack overflows.

### 8.3.1 Recursively Calculating a Sum

Useful recursive subroutines always contain a terminating condition. When the terminating condition becomes true, the stack unwinds when the program executes all pending RET instructions. To illustrate, let's consider the recursive procedure named **CalcSum**, which sums the integers 1 to  $n$ , where  $n$  is an input parameter passed in ECX. CalcSum returns the sum in EAX:

```

; Sum of Integers                (RecursiveSum.asm)
INCLUDE Irvine32.inc
.code
main PROC
    mov  ecx,5                ; count = 5
    mov  eax,0                ; holds the sum
    call CalcSum              ; calculate sum
L1:    call WriteDec           ; display EAX
    call Crlf                 ; new line
    exit
main ENDP

;-----
CalcSum PROC
; Calculates the sum of a list of integers
; Receives: ECX = count
; Returns: EAX = sum
;-----
    cmp  ecx,0                ; check counter value
    jz   L2                    ; quit if zero
    add  eax,ecx               ; otherwise, add to sum
    dec  ecx                  ; decrement counter
    call CalcSum              ; recursive call

```

```

L2: ret
CalcSum ENDP
end Main

```

The first two lines of **CalcSum** check the counter and exit the procedure when  $ECX = 0$ . The code bypasses further recursive calls. When the **RET** instruction is reached for the first time, it returns to the previous call to **CalcSum**, which returns to *its* previous call, and so on. Table 8-1 shows the return addresses (as labels) pushed on the stack by the **CALL** instruction, along with the concurrent values of **ECX** (counter) and **EAX** (sum).

Table 8-1 Stack Frame and Registers (CalcSum).

| Pushed on Stack | Value in ECX | Value in EAX |
|-----------------|--------------|--------------|
| L1              | 5            | 0            |
| L2              | 4            | 5            |
| L2              | 3            | 9            |
| L2              | 2            | 12           |
| L2              | 1            | 14           |
| L2              | 0            | 15           |

Even a simple recursive procedure makes ample use of the stack. At the very minimum, four bytes of stack space are used up each time a procedure call takes place because the return address must be saved on the stack.

### 8.3.2 Calculating a Factorial

Recursive subroutines often store temporary data in stack parameters. When the recursive calls unwind, the data saved on the stack can be useful. The next example we will look at calculates the factorial of an integer  $n$ . The *factorial* algorithm calculates  $n!$ , where  $n$  is an unsigned integer. The first time the **factorial** function is called, the parameter  $n$  is the starting number, shown here programmed in C/C++/Java syntax:

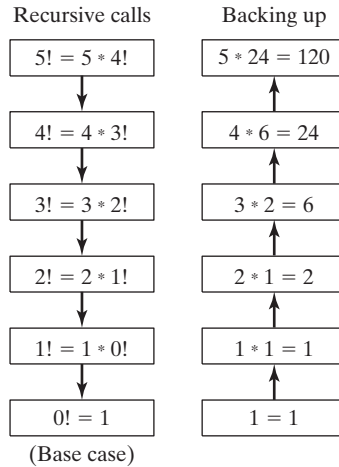
```

int function factorial(int n)
{
    if(n == 0)
        return 1;
    else
        return n * factorial(n-1);
}

```

Given any number  $n$ , we assume we can calculate the factorial of  $n - 1$ . If so, we can continue to reduce  $n$  until it equals zero. By definition,  $0!$  equals 1. In the process of backing up to the original expression  $n!$ , we accumulate the product of each multiplication. For example, to calculate  $5!$ , the recursive algorithm descends along the left column of Fig. 8-4 and backs up along the right column.

FIGURE 8-4 Recursive calls to the factorial function.



**Example Program** The following assembly language program contains a procedure named **Factorial** that uses recursion to calculate a factorial. We pass  $n$  (an unsigned integer between 0 and 12) on the stack to the **Factorial** procedure, and a value is returned in EAX. Because EAX is a 32-bit register, the largest factorial it can hold is 12! (479,001,600).

```

; Calculating a Factorial (Fact.asm)

INCLUDE Irvine32.inc
.code
main PROC
    push 5                ; calc 5!
    call Factorial        ; calculate factorial (EAX)
    call WriteDec         ; display it
    call Crlf
    exit
main ENDP

;-----
Factorial PROC
; Calculates a factorial.
; Receives: [ebp+8] = n, the number to calculate
; Returns: eax = the factorial of n
;-----

    push ebp
    mov  ebp,esp
    mov  eax,[ebp+8]      ; get n
    cmp  eax,0           ; n > 0?
    ja   L1              ; yes: continue
    mov  eax,1           ; no: return 1 as the value of 0!
    jmp  L2              ; and return to the caller

```

```

L1: dec  eax
    push eax                ; Factorial(n-1)
    call Factorial

; Instructions from this point on execute when each
; recursive call returns.

ReturnFact:
    mov  ebx,[ebp+8]       ; get n
    mul  ebx               ; EDX:EAX = EAX * EBX

L2: pop  ebp               ; return EAX
    ret  4                 ; clean up stack
Factorial ENDP
END main

```

Let's examine the Factorial procedure more closely by tracking a call to it with an initial value of  $N = 3$ . As documented in its specifications, Factorial assigns its return value to the EAX register:

```

push 3
call Factorial           ; EAX = 3!

```

The Factorial procedure receives one stack parameter,  $N$ , which is the starting value that determines which factorial to calculate. The calling program's return address is automatically pushed on the stack by the CALL instruction. The first thing Factorial does is to push EBP on the stack, to save the base pointer to the calling program's stack:

```

Factorial PROC
    push ebp

```

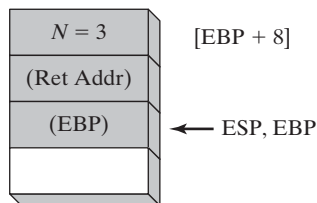
Next, it must set EBP to the beginning of the current stack frame:

```

    mov  ebp,esp

```

Now that EBP and ESP both point to the top of the stack, the runtime stack contains the following stack frame. It contains the parameter  $N$ , the caller's return address, and the saved value of EBP:



The same diagram shows that in order to retrieve the value of  $N$  from the stack and load it into EAX, the code must add 8 to the value of EBP, using base-offset addressing:

```

    mov  eax,[ebp+8]       ; get n

```

Next, the code checks the *base case*, the condition that stops the recursion. If  $N$  (currently in EAX) equals zero, the function returns 1, defined as  $0!$

```

    cmp    eax,0           ; is n > 0?
    ja     L1             ; yes: continue
    mov    eax,1           ; no: return 1 as the value of 0!
    jmp    L2             ; and return to the caller

```

(We will examine the code at label L2 later.) Since the value in EAX is currently equal to 3, Factorial will call itself recursively. First, it subtracts 1 from  $N$  and pushes the new value on the stack. This value is the parameter that is passed with the new call to Factorial:

```

L1:  dec    eax
     push  eax           ; Factorial(n - 1)
     call  Factorial

```

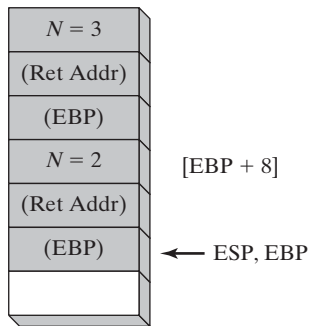
Execution now transfers to the first line of Factorial, with a new value of  $N$ :

```

Factorial PROC
    push  ebp
    mov   ebp,esp

```

The runtime stack now holds a second stack frame, with  $N$  equal to 2:



The value of  $N$ , which is now 2, is loaded into EAX and compared to zero.

```

    mov    eax,[ebp+8]     ; N = 2 at this point
    cmp    eax,0           ; compare N to zero
    ja     L1             ; still greater than zero
    mov    eax,1           ; not executed
    jmp    L2             ; not executed

```

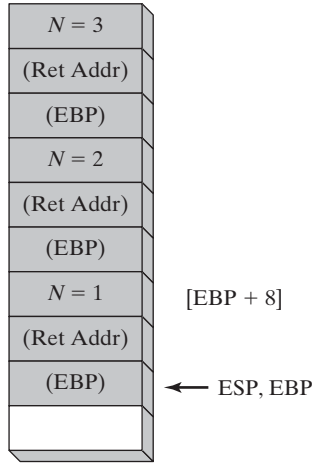
It is greater than zero, so execution continues at label L1.

**Tip:** You may have observed that the previous value of EAX, assigned during the first call to Factorial, was just overwritten by a new value. This illustrates an important point: when making recursive calls to a procedure, you should take careful note of which registers are modified. If you need to save any of these register values, push them on the stack before making the recursive call, and then pop them back off the stack after returning from the call. Fortunately, in the Factorial procedure it is not necessary to save the contents of EAX across recursive procedure calls.

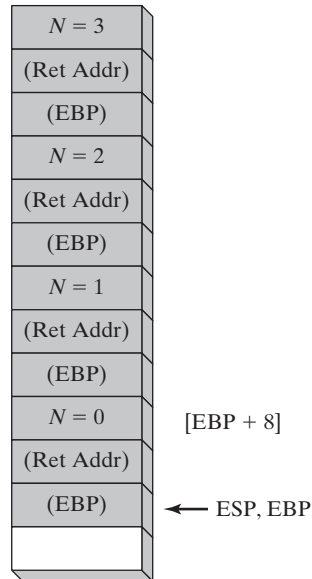
At L1, we are about to use a recursive procedure call to get the factorial of  $N - 1$ . The code subtracts 1 from EAX, pushes it on the stack, and calls Factorial:

```
L1: dec  eax           ; N = 1
    push eax         ; Factorial(1)
    call Factorial
```

Now, entering Factorial a third time, three stack frames are active:



The Factorial procedure compares  $N$  to 0, and on finding that  $N$  is greater than zero, calls Factorial one more time with  $N = 0$ . The runtime stack now contains its fourth stack frame as it enters the Factorial procedure for the last time:



When Factorial is called with  $N = 0$ , things get interesting. The following statements cause a branch to label L2. The value 1 is assigned to EAX because  $0! = 1$ , and EAX must be assigned Factorial's return value:

```

mov   eax,[ebp+8]      ; EAX = 0
cmp   eax,0           ; is n > 0?
ja    L1              ; yes: continue
mov   eax,1           ; no: return 1 as the value of 0!
jmp   L2              ; and return to the caller

```

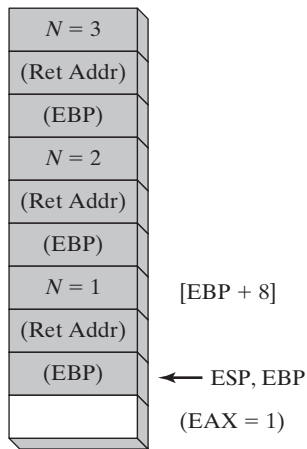
The following statements at label L2 cause Factorial to return to where it was last called:

```

L2:  pop   ebp          ; return EAX
      ret   4           ; clean up stack

```

At this point, the following figure shows that the most recent frame is no longer in the runtime stack, and EAX contains 1 (the factorial of Zero):



The following lines are the return point from the call to Factorial. They take the current value of  $N$  (stored on the stack at  $EBP + 8$ ), multiply it against EAX (the value returned by the call to Factorial). The product in EAX is now the return value of this iteration of Factorial:

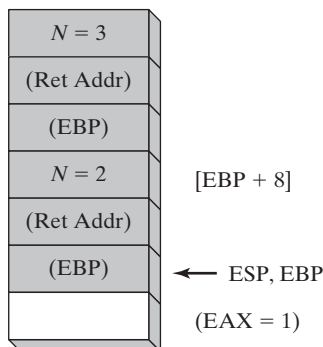
```

ReturnFact:
    mov   ebx,[ebp+8]      ; get n
    mul   ebx              ; EAX = EAX * EBX
L2:  pop   ebp          ; return EAX
      ret   4           ; clean up stack
Factorial ENDP

```



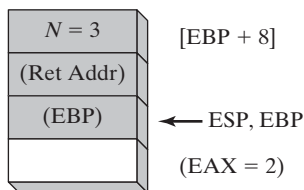
(The upper half of the product in EDX is all zeros, and is ignored.) Therefore, the first time the foregoing lines are reached, EAX is assigned the product of the expression  $1 \times 1$ . As the RET statement executes, another frame is removed from the stack:



Again, the statements following the CALL instruction execute, multiplying  $N$  (which now equals 2) by the value in EAX (equal to 1):

```
ReturnFact:
    mov  ebx,[ebp+8]      ; get n
    mul  ebx              ; EDX:EAX = EAX * EBX
L2:  pop  ebp             ; return EAX
    ret  4                ; clean up stack
Factorial ENDP
```

With EAX now equal to 2, the RET statement removes another frame from the stack:



Finally, the statements following the CALL instruction execute one last time, multiplying  $N$  (equal to 3) by the value in EAX (equal to 2):

```
ReturnFact:
    mov  ebx,[ebp+8]      ; get n
    mul  ebx              ; EDX:EAX = EAX * EBX
L2:  pop  ebp             ; return EAX
    ret  4                ; clean up stack
Factorial ENDP
```

The return value in EAX, 6, is the computed value of 3 factorial. This was the calculation we sought when first calling Factorial. The last stack frame disappears when the RET statement executes.

### 8.3.3 Section Review

1. (*True/False*): Given the same task to accomplish, a recursive subroutine usually uses less memory than a nonrecursive one.
2. In the Factorial function, what condition terminates the recursion?
3. Which instructions in the assembly language Factorial procedure execute after each recursive call has finished?
4. What would happen to the Factorial program's output if you tried to calculate 13!?
5. *Challenge*: How many bytes of stack space would be used by the Factorial procedure when calculating 5!?

## 8.4 INVOKE, ADDR, PROC, and PROTO

In 32-bit mode, the INVOKE, PROC, and PROTO directives provide powerful tools for defining and calling procedures. Along with these directives, the ADDR operator is an essential tool for defining procedure parameters. In many ways, these directives approach the convenience offered by high-level programming languages. From a pedagogical point of view, their use is controversial because they mask the underlying structure of the runtime stack. Before using them, you would be wise to develop a detailed understanding of the low-level mechanics involved in subroutine calls.

There is a situation in which using advanced procedure directives leads to better programming—when your program executes procedure calls across module boundaries. In such cases, the PROTO directive helps the assembler to validate procedure calls by checking argument lists against procedure declarations. This feature encourages advanced assembly language programmers to take advantage of the convenience offered by advanced MASM directives.

### 8.4.1 INVOKE Directive

The INVOKE directive, only available in 32-bit mode, pushes arguments on the stack (in the order specified by the MODEL directive's language specifier) and calls a procedure. INVOKE is a convenient replacement for the CALL instruction because it lets you pass multiple arguments using a single line of code. Here is the general syntax:

```
INVOKE procedureName [, argumentList]
```

*ArgumentList* is an optional comma-delimited list of arguments passed to the procedure. Using the CALL instruction, for example, we could call a procedure named DumpArray after executing several PUSH instructions:

```
push TYPE array
push LENGTHOF array
push OFFSET array
call DumpArray
```

The equivalent statement using INVOKE is reduced to a single line in which the arguments are listed in reverse order (assuming STDCALL is in effect):

```
INVOKE DumpArray, OFFSET array, LENGTHOF array, TYPE array
```

INVOKE permits almost any number of arguments, and individual arguments can appear on separate source code lines. The following INVOKE statement includes helpful comments:

```
INVOKE DumpArray,           ; displays an array
      OFFSET array,        ; points to the array
      LENGTHOF array,      ; the array length
      TYPE array           ; array component size
```

Argument types are listed in Table 8-2.

TABLE 8-2 Argument types used with INVOKE.

| Type               | Examples                             |
|--------------------|--------------------------------------|
| Immediate value    | 10, 3000h, OFFSET mylist, TYPE array |
| Integer expression | (10 * 20), COUNT                     |
| Variable           | myList, array, myWord, myDword       |
| Address expression | [myList+2], [ebx + esi]              |
| Register           | eax, bl, edi                         |
| ADDR <i>name</i>   | ADDR myList                          |
| OFFSET <i>name</i> | OFFSET myList                        |

**EAX, EDX Overwritten** If you pass arguments smaller than 32 bits to a procedure, INVOKE frequently causes the assembler to overwrite EAX and EDX when it widens the arguments before pushing them on the stack. You can avoid this behavior by always passing 32-bit arguments to INVOKE, or you can save and restore EAX and EDX before and after the procedure call.

### 8.4.2 ADDR Operator

The ADDR operator, also available in 32-bit mode, can be used to pass a pointer argument when calling a procedure using INVOKE. The following INVOKE statement, for example, passes the address of **myArray** to the **FillArray** procedure:

```
INVOKE FillArray, ADDR myArray
```

The argument passed to ADDR must be an assembly time constant. The following is an error:

```
INVOKE mySub, ADDR [ebp+12] ; error
```

The ADDR operator can only be used in conjunction with INVOKE. The following is an error:

```
mov esi, ADDR myArray ; error
```

**Example** The following INVOKE directive calls **Swap**, passing it the addresses of the first two elements in an array of doublewords:

```
.data
Array DWORD 20 DUP(?)
.code
...
INVOKE Swap,
      ADDR Array,
      ADDR [Array+4]
```

Here is the corresponding code generated by the assembler, assuming STDCALL is in effect:

```
push OFFSET Array+4
push OFFSET Array
call Swap
```

### 8.4.3 PROC Directive

#### **Syntax of the PROC Directive**

In 32-bit mode, the PROC directive has the following basic syntax:

```
label PROC [attributes] [USES reglist], parameter_list
```

*Label* is a user-defined label following the rules for identifiers explained in Chapter 3. *Attributes* refers to any of the following:

```
[distance] [langtype] [visibility] [prologuearg]
```

Table 8-3 describes each of the attributes.

Table 8-3 Attributes field in the PROC directive.

| Attribute   | Description                                                                                                                                                                                                                                                         |
|-------------|---------------------------------------------------------------------------------------------------------------------------------------------------------------------------------------------------------------------------------------------------------------------|
| distance    | NEAR or FAR. Indicates the type of RET instruction (RET or RETF) generated by the assembler.                                                                                                                                                                        |
| langtype    | Specifies the calling convention (parameter passing convention) such as C, PASCAL, or STDCALL. Overrides the language specified in the .MODEL directive.                                                                                                            |
| visibility  | Indicates the procedure's visibility to other modules. Choices are PRIVATE, PUBLIC (default), and EXPORT. If the visibility is EXPORT, the linker places the procedure's name in the export table for segmented executables. EXPORT also enables PUBLIC visibility. |
| prologuearg | Specifies arguments affecting generation of prologue and epilogue code.                                                                                                                                                                                             |

#### **Parameter Lists**

The PROC directive permits you to declare a procedure with a comma-separated list of named parameters. Your implementation code can refer to the parameters by name rather than by calculated stack offsets such as [ebp+8]:

```
label PROC [attributes] [USES reglist],
    parameter_1,
    parameter_2,
    .
    .
    parameter_n
```

The comma following PROC can be omitted if the parameter list appears on the same line:

```
label PROC [attributes], parameter_1, parameter_2, ..., parameter_n
```

A single parameter has the following syntax:

*paramName*: *type*

*ParamName* is an arbitrary name you assign to the parameter. Its scope is limited to the current procedure (called *local scope*). The same parameter name can be used in more than one procedure, but it cannot be the name of a global variable or code label. *Type* can be one of the following: BYTE, SBYTE, WORD, SWORD, DWORD, SDWORD, FWORD, QWORD, or TBYTE. It can also be a *qualified type*, which may be a pointer to an existing type. Following are examples of qualified types:

|           |            |
|-----------|------------|
| PTR BYTE  | PTR SBYTE  |
| PTR WORD  | PTR SWORD  |
| PTR DWORD | PTR SDWORD |
| PTR QWORD | PTR TBYTE  |

Though it is possible to add NEAR and FAR attributes to these expressions, they are relevant only in more specialized applications. Qualified types can also be created using the TYPEDEF and STRUCT directives, which we explain in Chapter 10.

**Example 1** The AddTwo procedure receives two doubleword values and returns their sum in EAX:

```
AddTwo PROC,
    val1:DWORD,
    val2:DWORD
    mov  eax, val1
    add  eax, val2
    ret
AddTwo ENDP
```

The assembly language generated by MASM when assembling AddTwo shows how the parameter names are translated into offsets from EBP. A constant operand is appended to the RET instruction because STDCALL is in effect:

```
AddTwo PROC
    push ebp
    mov  ebp, esp
    mov  eax, dword ptr [ebp+8]
    add  eax, dword ptr [ebp+0Ch]
    leave
    ret  8
AddTwo ENDP
```

*Note:* It would be just as correct to substitute the ENTER 0,0 instruction in place of the following statements in the AddTwo procedure:

```
push  ebp
mov   ebp, esp
```

**Tip:** To view details of MASM-generated procedure code, open your program with a debugger and view the Disassembly window.

*Example 2* The FillArray procedure receives a pointer to an array of bytes:

```
FillArray PROC,
    pArray:PTR BYTE
    . . .
FillArray ENDP
```

*Example 3* The Swap procedure receives two pointers to doublewords:

```
Swap PROC,
    pValX:PTR DWORD,
    pValY:PTR DWORD
    . . .
Swap ENDP
```

*Example 4* The Read\_File procedure receives a byte pointer named **pBuffer**. It has a local doubleword variable named **fileHandle**, and it saves two registers on the stack (EAX and EBX):

```
Read_File PROC USES eax ebx,
    pBuffer:PTR BYTE
    LOCAL fileHandle:DWORD

    mov  esi,pBuffer
    mov  fileHandle,eax
    .
    .
    ret
Read_File ENDP
```

The MASM-generated code for Read\_File shows how space is reserved on the stack for the local variable (fileHandle) before pushing EAX and EBX (specified in the USES clause):

```
Read_File PROC
    push  ebp
    mov   ebp,esp
    add   esp,0FFFFFFFh           ; create fileHandle
    push  eax                     ; save EAX
    push  ebx                     ; save EBX
    mov   esi,dword ptr [ebp+8]   ; pBuffer
    mov   dword ptr [ebp-4],eax   ; fileHandle
    pop   ebx
    pop   eax
    leave
    ret  4
Read_File ENDP
```

*Note:* Although Microsoft chose not to do so, another way to begin the generated code for Read\_File would have been this:

```
Read_File PROC
    enter 4,0
    push  eax
    (etc.)
```

The ENTER instruction saves EBP, sets it to the value of the stack pointer, and reserves space for the local variable.

**RET Instruction Modified by PROC** When PROC is used with one or more parameters and STDCALL is the default protocol, MASM generates the following entry and exit code, assuming PROC has  $n$  parameters:

```

push  ebp
mov   ebp,esp
.
.
leave
ret   (n*4)

```

The constant appearing in the RET instruction is the number of parameters multiplied by 4 (because each parameter is a doubleword). The STDCALL convention is the default when you INCLUDE Irvine32.inc, and it is the calling convention used for all Windows API function calls.

### Specifying the Parameter Passing Protocol

A program might call Irvine32 library procedures and in turn contain procedures that can be called from C++ programs. To provide this flexibility, the *attributes* field of the PROC directive lets you specify the language convention for passing parameters. It overrides the default language convention specified in the .MODEL directive. The following example declares a procedure with the C calling convention:

```

Example1 PROC C,
    parm1:DWORD, parm2:DWORD

```

If we execute Example1 using INVOKE, the assembler generates code consistent with the C calling convention. Similarly, if we declare Example1 using STDCALL, INVOKE generates consistent with that language convention:

```

Example1 PROC STDCALL,
    parm1:DWORD, parm2:DWORD

```

### 8.4.4 PROTO Directive

In 64-bit mode, we use the PROTO directive to identify a procedure that is external to the program, as in the following example:

```

ExitProcess PROTO
.code
mov  ecx,0
call ExitProcess

```

In 32-bit mode, however, PROTO is a good deal more powerful because it can include a list of procedure parameters. We say that the PROTO directive creates a *prototype* for an existing procedure. A prototype declares a procedure's name and parameter list. It allows you to call a procedure before defining it and to verify that the number and types of arguments match the procedure definition.

MASM requires a prototype for each procedure called by INVOKE. PROTO must appear first before INVOKE. In other words, the standard ordering of these directives is

```
MySub PROTO                                ; procedure prototype
.
INVOKE MySub                               ; procedure call
.
MySub PROC                                 ; procedure implementation
.
.
MySub ENDP
```

An alternative scenario is possible: The procedure implementation can appear in the program prior to the location of the INVOKE statement for that procedure. In that case, PROC acts as its own prototype:

```
MySub PROC                                 ; procedure definition
.
.
MySub ENDP
.
INVOKE MySub                               ; procedure call
```

Assuming you have already written a particular procedure, you can easily create its prototype by copying the PROC statement and making the following changes:

- Change the word PROC to PROTO.
- Remove the USES operator if any, along with its register list.

For example, suppose we have already created the **ArraySum** procedure:

```
ArraySum PROC USES esi ecx,
    ptrArray:PTR DWORD,                ; points to the array
    szArray:DWORD                      ; array size
    ; (remaining lines omitted...)
ArraySum ENDP
```

This is a matching PROTO declaration:

```
ArraySum PROTO,
    ptrArray:PTR DWORD,                ; points to the array
    szArray:DWORD                      ; array size
```

The PROTO directive lets you override the default parameter passing protocol in the .MODEL directive. It must be consistent with the procedure's PROC declaration:

```
Example1 PROTO C,
    parm1:DWORD, parm2:DWORD
```

### **Assembly Time Argument Checking**

The PROTO directive helps the assembler compare a list of arguments in a procedure call to the procedure's definition. The error checking is not as precise as you would find in languages like C and C++. Instead, MASM checks for the correct number of parameters, and to a limited extent, matches argument types to parameter types. Suppose, for example, the prototype for **Sub1** is declared thus:

```
Sub1 PROTO, p1:BYTE, p2:WORD, p3:PTR BYTE
```



We will define the following variables:

```
.data
byte_1  BYTE  10h
word_1  WORD  2000h
word_2  WORD  3000h
dword_1  DWORD 12345678h
```

The following is a valid call to Sub1:

```
INVOKE Sub1, byte_1, word_1, ADDR byte_1
```

The code generated by MASM for this INVOKE shows arguments pushed on the stack in reverse order:

```
push  404000h                ; ptr to byte_1
sub   esp,2                  ; pad stack with 2 bytes
push  word ptr ds:[00404001h] ; value of word_1
mov   al,byte ptr ds:[00404000h] ; value of byte_1
push  eax
call  00401071
```

EAX is overwritten, and the **sub esp,2** instruction pads the subsequent stack entry to 32 bits.

*Errors Detected by MASM* If an argument exceeds the size of a declared parameter, MASM generates an error:

```
INVOKE Sub1, word_1, word_2, ADDR byte_1      ; arg 1 error
```

MASM generates errors if we invoke Sub1 using too few or too many arguments:

```
INVOKE Sub1, byte_1, word_2          ; error: too few arguments
INVOKE Sub1, byte_1,                ; error: too many arguments
    word_2, ADDR byte_1, word_2
```

*Errors Not Detected by MASM* If an argument's type is smaller than a declared parameter, MASM does not detect an error:

```
INVOKE Sub1, byte_1, byte_1, ADDR byte_1
```

Instead, MASM expands the smaller argument to the size of the declared parameter. In the following code generated by our INVOKE example, the second argument (byte\_1) is expanded into EAX before pushing it on the stack:

```
push  404000h                ; addr of byte_1
mov   al,byte ptr ds:[00404000h] ; value of byte_1
movzx eax,al                 ; expand into EAX
push  eax                    ; push on stack
mov   al,byte ptr ds:[00404000h] ; value of byte_1
push  eax                    ; push on stack
call  00401071                ; call Sub1
```

If a doubleword is passed when a pointer was expected, no error is detected. This type of error usually leads to a runtime error when the subroutine tries to use the stack parameter as a pointer:

```
INVOKE Sub1, byte_1, word_2, dword_1      ; no error detected
```

### **ArraySum Example**

Let's revisit the **ArraySum** procedure from Chapter 5, which calculates the sum of an array of doublewords. Originally, we passed arguments in registers; now we can use the PROC directive to declare stack parameters:

```
ArraySum PROC USES esi ecx,
    ptrArray:PTR DWORD,      ; points to the array
    szArray:DWORD           ; array size
    mov esi,ptrArray        ; address of the array
    mov ecx,szArray         ; size of the array
    mov eax,0               ; set the sum to zero
    cmp ecx,0               ; length = zero?
    je L2                   ; yes: quit
L1: add eax,[esi]           ; add each integer to sum
    add esi,4               ; point to next integer
    loop L1                 ; repeat for array size
L2: ret                    ; sum is in EAX
ArraySum ENDP
```

The INVOKE statement calls **ArraySum**, passing the address of an array and the number of elements in the array:

```
.data
array DWORD 10000h,20000h,30000h,40000h,50000h
theSum DWORD ?
.code
main PROC
    INVOKE ArraySum,
        ADDR array,          ; address of the array
        LENGTHOF array      ; number of elements
    mov theSum,eax          ; store the sum
```

### **8.4.5 Parameter Classifications**

Procedure parameters are usually classified according to the direction of data transfer between the calling program and the called procedure:

- **Input:** An input parameter is data passed by a calling program to a procedure. The called procedure is not expected to modify the corresponding parameter variable, and even if it does, the modification is confined to the procedure itself.
- **Output:** An output parameter is created when a calling program passes the address of a variable to a procedure. The procedure uses the address to locate and assign data to the variable. The Win32 Console Library, for example, has a function named **ReadConsole** that

reads a string of characters from the keyboard. The calling program passes a pointer to a string buffer, into which ReadConsole stores text typed by the user:

```
.data
buffer BYTE 80 DUP(?)
inputHandle DWORD ?
.code
INVOKE ReadConsole, inputHandle, ADDR buffer,
    (etc.)
```

- **Input–Output:** An input–output parameter is identical to an output parameter, with one exception: The called procedure expects the variable referenced by the parameter to contain some data. The procedure is also expected to modify the variable via the pointer.

### 8.4.6 Example: Exchanging Two Integers

The following program exchanges the contents of two 32-bit integers. The Swap procedure has two input–output parameters named **pValX** and **pValY**, which contain the addresses of data to be exchanged:

```
; Swap Procedure Example                                (Swap.asm)
INCLUDE Irvine32.inc
Swap PROTO, pValX:PTR DWORD, pValY:PTR DWORD

.data
Array DWORD 10000h,20000h

.code
main PROC
    ; Display the array before the exchange:
    mov  esi,OFFSET Array
    mov  ecx,2                                ; count = 2
    mov  ebx,TYPE Array
    call DumpMem                               ; dump the array values
    INVOKE Swap, ADDR Array, ADDR [Array+4]
    ; Display the array after the exchange:
    call DumpMem
    exit
main ENDP

;-----
Swap PROC USES eax esi edi,
    pValX:PTR DWORD,                ; pointer to first integer
    pValY:PTR DWORD                ; pointer to second integer
;
; Exchange the values of two 32-bit integers
; Returns: nothing
;-----
    mov  esi,pValX                    ; get pointers
    mov  edi,pValY
    mov  eax,[esi]                    ; get first integer
    xchg eax,[edi]                    ; exchange with second
    mov  [esi],eax                    ; replace first integer
```

```

        ret                                ; PROC generates RET 8 here
Swap ENDP
END main

```

The two parameters in the `Swap` procedure, `pValX` and `pValY`, are input–output parameters. Their existing values are *input* to the procedure, and their new values are also *output* from the procedure. Because we’re using `PROC` with parameters, the assembler changes the `RET` instruction at the end of `Swap` to **RET 8** (assuming `STDCALL` is the calling convention).

### 8.4.7 Debugging Tips

In this section, we call attention to a few common errors encountered when passing arguments to procedures in assembly language. We hope you never make these mistakes.

#### **Argument Size Mismatch**

Array addresses are based on the sizes of their elements. To address the second element of a doubleword array, for example, one adds 4 to the array’s starting address. Suppose we call `Swap` from Section 8.4.6, passing pointers to the first two elements of `DoubleArray`. If we incorrectly calculate the address of the second element as `DoubleArray + 1`, the resulting hexadecimal values in `DoubleArray` after calling `Swap` are incorrect:

```

.data
DoubleArray DWORD 10000h,20000h
.code
INVOKE Swap, ADDR [DoubleArray + 0], ADDR [DoubleArray + 1]

```

#### **Passing the Wrong Type of Pointer**

When using `INVOKE`, remember that the assembler does not validate the type of pointer you pass to a procedure. For example, the `Swap` procedure from Section 8.4.6 expects to receive two doubleword pointers. Suppose we inadvertently pass it pointers to bytes:

```

.data
ByteArray BYTE 10h,20h,30h,40h,50h,60h,70h,80h
.code
INVOKE Swap, ADDR [ByteArray + 0], ADDR [ByteArray + 1]

```

The program will assemble and run, but when `ESI` and `EDI` are dereferenced, 32-bit values are exchanged.

#### **Passing Immediate Values**

If a procedure has a reference parameter, do not pass it an immediate argument. Consider the following procedure, which has a single reference parameter:

```

Sub2 PROC, dataPtr:PTR WORD
    mov esi,dataPtr          ; get the address
    mov WORD PTR [esi],0    ; dereference, assign zero
    ret
Sub2 ENDP

```

The following INVOKE statement assembles but causes a runtime error. The **Sub2** procedure receives 1000h as a pointer value and dereferences memory location 1000h:

```
INVOKE Sub2, 1000h
```

The example is likely to cause a general protection fault, because memory location 1000h is not likely to be within the program's data segment.

### 8.4.8 WriteStackFrame Procedure

The Irvine32 library contains a useful procedure named **WriteStackFrame** that displays the contents of the current procedure's stack frame. It shows the procedure's stack parameters, return address, local variables, and saved registers. It was generously provided by Professor James Brink of Pacific Lutheran University. Here is the prototype:

```
WriteStackFrame PROTO,
    numParam:DWORD,          ; number of passed parameters
    numLocalVal: DWORD,      ; number of DWordLocal variables
    numSavedReg: DWORD       ; number of saved registers
```

Here's an excerpt from a program that demonstrates WriteStackFrame:

```
main PROC
    mov eax, 0EAEAEAEAh
    mov ebx, 0EBEBEBEBh
    INVOKE myProc, 1111h, 2222h ; pass two integer arguments
    exit
main ENDP

myProc PROC USES eax ebx,
    x: DWORD, y: DWORD
    LOCAL a:DWORD, b:DWORD

    PARAMS = 2
    LOCALS = 2
    SAVED_REGS = 2
    mov a,0AAAAh
    mov b,0BBBBh
    INVOKE WriteStackFrame, PARAMS, LOCALS, SAVED_REGS
```

The following sample output was produced by the call:

```
Stack Frame
00002222 ebp+12 (parameter)
00001111 ebp+8 (parameter)
00401083 ebp+4 (return address)
0012FFF0 ebp+0 (saved ebp) <--- ebp
0000AAAA ebp-4 (local variable)
0000BBBB ebp-8 (local variable)
EAEAEAEA ebp-12 (saved register)
EBEBEBEB ebp-16 (saved register) <--- esp
```

A second procedure, named **WriteStackFrameName**, has an additional parameter that holds the name of the procedure owning the stack frame:

```
WriteStackFrameName PROTO,
    numParam:DWORD,           ; number of passed parameters
    numLocalVal:DWORD,       ; number of DWORD local variables
    numSavedReg:DWORD,       ; number of saved registers
    procName:PTR BYTE        ; null-terminated string
```

You can find the source code for the Irvine32 library in the \Examples\Lib32 directory of our book's install directory (usually *C:\Irvine*). Look for the file named *Irvine32.asm*.

### 8.4.9 Section Review

1. (*True/False*): The CALL instruction cannot include procedure arguments.
2. (*True/False*): The INVOKE directive can include up to a maximum of three arguments.
3. (*True/False*): The INVOKE directive can only pass memory operands, but not register values.
4. (*True/False*): The PROC directive can contain a USES operator, but the PROTO directive cannot.

## 8.5 Creating Multimodule Programs

Large source files are hard to manage and slow to assemble. You could break a single file into multiple include files, but a modification to any source file would still require a complete assembly of all the files. A better approach is to divide up a program into *modules* (assembled units). Each module is assembled independently, so a change to one module's source code only requires reassembling the single module. The linker combines all assembled modules (OBJ files) into a single executable file rather quickly. Linking large numbers of object modules requires far less time than assembling the same number of source code files.

There are two general approaches to creating multimodule programs: The first is the traditional one, using the EXTERN directive, which is more or less portable across different x86 assemblers. The second approach is to use Microsoft's advanced INVOKE and PROTO directives, which simplify procedure calls and hide some low-level details. We will demonstrate both approaches and let you decide which you want to use.

### 8.5.1 Hiding and Exporting Procedure Names

By default, MASM makes all procedures public, permitting them to be called from any other module in the same program. You can override this behavior using the PRIVATE qualifier:

```
mySub PROC PRIVATE
```

By making procedures private, you use the principle of *encapsulation* to hide procedures inside modules and avoid potential name clashes when procedures in different modules have the same names.

**OPTION PROC:PRIVATE Directive** Another way to hide procedures inside a source module is to place the OPTION PROC:PRIVATE directive at the top of the file. All procedures become private by default. Then, you use the PUBLIC directive to identify any procedures you want to export:

```
OPTION PROC:PRIVATE
PUBLIC mySub
```

The `PUBLIC` directive takes a comma-delimited list of names:

```
PUBLIC sub1, sub2, sub3
```

Alternatively, you can designate individual procedures as public:

```
mySub PROC PUBLIC
.
mySub ENDP
```

If you use `OPTION PROC:PRIVATE` in your program's startup module, be sure to designate your startup procedure (usually `main`) as `PUBLIC`, or the operating system's loader will not be able to find it. For example,

```
main PROC PUBLIC
```

## 8.5.2 Calling External Procedures

The `EXTERN` directive, used when calling a procedure outside the current module, identifies the procedure's name and stack frame size. The following program example calls `sub1`, located in an external module:

```
INCLUDE Irvine32.inc
EXTERN sub1@0:PROC
.code
main PROC
    call sub1@0
    exit
main ENDP
END main
```

When the assembler discovers a missing procedure in a source file (identified by a `CALL` instruction), its default behavior is to issue an error message. Instead, `EXTERN` tells the assembler to create a blank address for the procedure. The linker resolves the missing address when it creates the program's executable file.

The `@n` suffix at the end of a procedure name identifies the total stack space used by declared parameters (see the extended `PROC` directive in Section 8.4). If you're using the basic `PROC` directive with no declared parameters, the suffix on each procedure name in `EXTERN` will be `@0`. If you declare a procedure using the extended `PROC` directive, add 4 bytes for every parameter. Suppose we declare `AddTwo` with two doubleword parameters:

```
AddTwo PROC,
    val1:DWORD,
    val2:DWORD
. . .
AddTwo ENDP
```

The corresponding `EXTERN` directive is `EXTERN AddTwo@8:PROC`. Alternatively, you can use the `PROTO` directive in place of `EXTERN`:

```
AddTwo PROTO,
    val1:DWORD,
    val2:DWORD
```

### 8.5.3 Using Variables and Symbols across Module Boundaries

#### **Exporting Variables and Symbols**

Variables and symbols are, by default, private to their enclosing modules. You can use the `PUBLIC` directive to export specific names, as in the following example:

```
PUBLIC count, SYM1
SYM1 = 10
.data
count DWORD 0
```

#### **Accessing External Variables and Symbols**

You can use the `EXTERN` directive to access variables and symbols defined in external modules:

```
EXTERN name : type
```

For symbols (defined with `EQU` and `=`), *type* should be `ABS`. For variables, *type* can be a data-definition attribute such as `BYTE`, `WORD`, `DWORD`, and `SDWORD`, including `PTR`. Here are examples:

```
EXTERN one:WORD, two:SDWORD, three:PTR BYTE, four:ABS
```

#### **Using an INCLUDE File with EXTERNDEF**

MASM has a useful directive named `EXTERNDEF` that takes the place of both `PUBLIC` and `EXTERN`. It can be placed in a text file and copied into each program module using the `INCLUDE` directive. For example, let's define a file named *vars.inc* containing the following declaration:

```
; vars.inc
EXTERNDEF count:DWORD, SYM1:ABS
```

Next, we create a source file named *sub1.asm* containing `count` and `SYM1`, an `INCLUDE` statement that copies *vars.inc* into the compile stream.

```
; sub1.asm
.386
.model flat,STDCALL
INCLUDE vars.inc
SYM1 = 10
.data
count DWORD 0
END
```

Because this is not the program startup module, we omit a program entry point label in the `END` directive, and we do not need to declare a runtime stack.



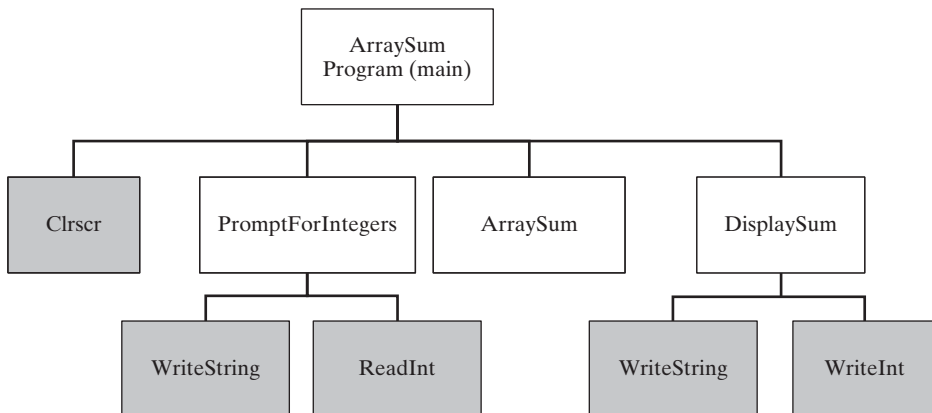
Next, we create a startup module named *main.asm* that includes *vars.inc* and makes references to *count* and *SYM1*:

```
; main.asm
.386
.model flat,stdcall
.stack 4096
ExitProcess proto, dwExitCode:dword
INCLUDE vars.inc
.code
main PROC
    mov     count,2000h
    mov     eax,SYM1
    INVOKE ExitProcess,0
main ENDP
END main
```

#### 8.5.4 Example: ArraySum Program

The *ArraySum* program, first presented in Chapter 5, is an easy program to separate into modules. For a quick review of the program's design, let's review the structure chart (Fig. 8-5). Shaded rectangles refer to procedures in the book's link library. The **main** procedure calls **PromptForIntegers**, which in turn calls **WriteString** and **ReadInt**. It's usually easiest to keep track of the various files in a multimodule program by creating a separate disk directory for the files. That's what we did for the *ArraySum* program, to be shown in the next section.

FIGURE 8-5 Structure chart, *ArraySum* program.



#### 8.5.5 Creating the Modules Using Extern

We will show two versions of the multimodule *ArraySum* program. This section will use the traditional **EXTERN** directive to reference functions in separate modules. Later, in Section 8.5.6, we will implement the same program using the advanced capabilities of **INVOKE**, **PROTO**, and **PROC**.

*PromptForIntegers* `_prompt.asm` contains the source code file for the `PromptForIntegers` procedure. It displays prompts asking the user to enter three integers, inputs the values by calling `ReadInt`, and inserts them in an array:

```

; Prompt For Integers          (_prompt.asm)
INCLUDE Irvine32.inc
.code
;-----
PromptForIntegers PROC
; Prompts the user for an array of integers and fills
; the array with the user's input.
; Receives:
;   ptrPrompt:PTR BYTE          ; prompt string
;   ptrArray:PTR DWORD         ; pointer to array
;   arraySize:DWORD           ; size of the array
; Returns:  nothing
;-----
arraySize EQU [ebp+16]
ptrArray  EQU [ebp+12]
ptrPrompt EQU [ebp+8]

    enter 0,0
    pushad                ; save all registers

    mov  ecx,arraySize
    cmp  ecx,0            ; array size <= 0?
    jle  L2              ; yes: quit
    mov  edx,ptrPrompt   ; address of the prompt
    mov  esi,ptrArray

L1:  call WriteString    ; display string
     call ReadInt      ; read integer into EAX
     call Crlf        ; go to next output line
     mov  [esi],eax    ; store in array
     add  esi,4        ; next integer
     loop L1

L2:  popad              ; restore all registers
     leave
     ret  12           ; restore the stack
PromptForIntegers ENDP
END

```

*ArraySum* The `_arraysum.asm` module contains the `ArraySum` procedure, which calculates the sum of the array elements and returns a result in EAX:

```

; ArraySum Procedure          (_arraysum.asm)
INCLUDE Irvine32.inc
.code
;-----
ArraySum PROC
;

```

```

; Calculates the sum of an array of 32-bit integers.
; Receives:
;   ptrArray           ; pointer to array
;   arraySize         ; size of array (DWORD)
; Returns:  EAX = sum
;-----
ptrArray EQU [ebp+8]
arraySize EQU [ebp+12]
    enter 0,0
    push ecx           ; don't push EAX
    push esi
    mov  eax,0         ; set the sum to zero
    mov  esi,ptrArray
    mov  ecx,arraySize
    cmp  ecx,0         ; array size <= 0?
    jle  L2           ; yes: quit
L1:  add  eax,[esi]    ; add each integer to sum
    add  esi,4         ; point to next integer
    loop L1           ; repeat for array size
L2:  pop  esi
    pop  ecx           ; return sum in EAX
    leave
    ret  8             ; restore the stack
ArraySum ENDP
END

```

*DisplaySum* The *\_display.asm* module contains the `DisplaySum` procedure, which displays a label, followed by the array sum:

```

; DisplaySum Procedure      (_display.asm)
INCLUDE Irvine32.inc
.code
;-----
DisplaySum PROC
; Displays the sum on the console.
; Receives:
;   ptrPrompt           ; offset of prompt string
;   theSum              ; the array sum (DWORD)
; Returns:  nothing
;-----
theSum    EQU [ebp+12]
ptrPrompt EQU [ebp+8]
    enter 0,0
    push eax
    push edx
    mov  edx,ptrPrompt ; pointer to prompt
    call WriteString
    mov  eax,theSum

```

```

        call WriteInt          ; display EAX
        call Crlf

        pop  edx
        pop  eax
        leave
        ret  8                ; restore the stack
DisplaySum ENDP
END

```

**Startup Module** The *Sum\_main.asm* module contains the startup procedure (main). It contains EXTERN directives for the three external procedures. To make the source code more user-friendly, the EQU directive redefines the procedure names:

```

ArraySum          EQU ArraySum@0
PromptForIntegers EQU PromptForIntegers@0
DisplaySum        EQU DisplaySum@0

```

Just before each procedure call, a comment describes the parameter order. This program uses the STDCALL parameter passing convention:

```

; Integer Summation Program (Sum_main.asm)
; Multimodule example:
; This program inputs multiple integers from the user,
; stores them in an array, calculates the sum of the
; array, and displays the sum.
INCLUDE Irvine32.inc

EXTERN PromptForIntegers@0:PROC
EXTERN ArraySum@0:PROC, DisplaySum@0:PROC

; Redefine external symbols for convenience
ArraySum          EQU ArraySum@0
PromptForIntegers EQU PromptForIntegers@0
DisplaySum        EQU DisplaySum@0

; modify Count to change the size of the array:
Count = 3

.data
prompt1 BYTE "Enter a signed integer: ",0
prompt2 BYTE "The sum of the integers is: ",0
array   DWORD Count DUP(?)
sum     DWORD ?

.code
main PROC
    call Clrscr

; PromptForIntegers( addr prompt1, addr array, Count )
    push Count
    push OFFSET array
    push OFFSET prompt1

```

```

        call  PromptForIntegers
; sum = ArraySum( addr array, Count )
        push  Count
        push  OFFSET array
        call  ArraySum
        mov   sum,eax

; DisplaySum( addr prompt2, sum )
        push  sum
        push  OFFSET prompt2
        call  DisplaySum

        call  Crlf
        exit
main ENDP
END main

```

The source files for this program are stored in the example programs directory in a folder named *ch08\ModSum32\_traditional*.

Next, we will see how this program would change if it were built using Microsoft's INVOKE and PROTO directives.

### 8.5.6 Creating the Modules Using INVOKE and PROTO

In 32-bit mode, multimodule programs may be created using Microsoft's advanced INVOKE, PROTO, and extended PROC directives (Section 8.4). Their primary advantage over the more traditional use of CALL and EXTERN is their ability to match up argument lists passed by INVOKE to corresponding parameter lists declared by PROC.

Let's recreate the ArraySum program, using the INVOKE, PROTO, and advanced PROC directives. A good first step is to create an include file containing a PROTO directive for each external procedure. Each module will include this file (using the INCLUDE directive) without incurring any code size or runtime overhead. If a module does not call a particular procedure, the corresponding PROTO directive is ignored by the assembler. The source code for this program is located in the *\ch08\ModSum32\_advanced* folder.

*The sum.inc Include File* Here is the *sum.inc* include file for our program:

```

; (sum.inc)
INCLUDE Irvine32.inc

PromptForIntegers PROTO,
    ptrPrompt:PTR BYTE,           ; prompt string
    ptrArray:PTR DWORD,          ; points to the array
    arraySize:DWORD              ; size of the array

ArraySum PROTO,
    ptrArray:PTR DWORD,          ; points to the array
    arraySize:DWORD              ; size of the array

DisplaySum PROTO,
    ptrPrompt:PTR BYTE,          ; prompt string
    theSum:DWORD                 ; sum of the array

```

*The \_prompt Module* The *\_prompt.asm* file uses the PROC directive to declare parameters for the PromptForIntegers procedure. It uses an INCLUDE to copy *sum.inc* into this file:

```

; Prompt For Integers      (_prompt.asm)
INCLUDE sum.inc           ; get procedure prototypes
.code
;-----
PromptForIntegers PROC,
    ptrPrompt:PTR BYTE,   ; prompt string
    ptrArray:PTR DWORD,   ; pointer to array
    arraySize:DWORD       ; size of the array
;
; Prompts the user for an array of integers and fills
; the array with the user's input.
; Returns:  nothing
;-----
    pushad                ; save all registers
    mov  ecx,arraySize
    cmp  ecx,0             ; array size <= 0?
    jle  L2                ; yes: quit
    mov  edx,ptrPrompt     ; address of the prompt
    mov  esi,ptrArray
L1:  call WriteString      ; display string
     call ReadInt         ; read integer into EAX
     call Crlf            ; go to next output line
     mov  [esi],eax        ; store in array
     add  esi,4            ; next integer
     loop L1
L2:  popad                 ; restore all registers
     ret
PromptForIntegers ENDP
END

```

Compared to the previous version of PromptForIntegers, the statements **enter 0, 0** and **leave** are now missing because they will be generated by MASM when it encounters the PROC directive with declared parameters. Also, the RET instruction needs no constant parameter (PROC takes care of that).

*The \_arraysum Module* Next, the *\_arraysum.asm* file contains the ArraySum procedure:

```

; ArraySum Procedure      (_arraysum.asm)
INCLUDE sum.inc
.code
;-----
ArraySum PROC,
    ptrArray:PTR DWORD,   ; pointer to array
    arraySize:DWORD       ; size of array
;
; Calculates the sum of an array of 32-bit integers.

```

```

; Returns:  EAX = sum
;-----
    push ecx                ; don't push EAX
    push esi
    mov  eax,0              ; set the sum to zero
    mov  esi,ptrArray
    mov  ecx,arraySize
    cmp  ecx,0              ; array size <= 0?
    jle  L2                 ; yes: quit
L1:  add  eax,[esi]         ; add each integer to sum
    add  esi,4              ; point to next integer
    loop L1                 ; repeat for array size
L2:  pop  esi
    pop  ecx                ; return sum in EAX
    ret
ArraySum ENDP
END

```

*The \_display Module* The *\_display.asm* file contains the DisplaySum procedure:

```

; DisplaySum Procedure      (_display.asm)
INCLUDE Sum.inc
.code
;-----
DisplaySum PROC,
    ptrPrompt:PTR BYTE,    ; prompt string
    theSum:DWORD           ; the array sum
;
; Displays the sum on the console.
; Returns:  nothing
;-----
    push  eax
    push  edx

    mov  edx,ptrPrompt     ; pointer to prompt
    call WriteString
    mov  eax,theSum
    call WriteInt         ; display EAX
    call Crlf

    pop  edx
    pop  eax
    ret
DisplaySum ENDP
END

```

*The Sum\_main Module* The *Sum\_main.asm* (startup module) contains main and calls each of the other procedures. It uses INCLUDE to copy in the procedure prototypes from *sum.inc*:

```

; Integer Summation Program (Sum_main.asm)

INCLUDE sum.inc
Count = 3
.data
prompt1 BYTE "Enter a signed integer: ",0
prompt2 BYTE "The sum of the integers is: ",0
array   DWORD  Count DUP(?)
sum     DWORD  ?

.code
main PROC
    call Clrscr

    INVOKE PromptForIntegers, ADDR prompt1, ADDR array, Count
    INVOKE ArraySum, ADDR array, Count
    mov     sum,eax
    INVOKE DisplaySum, ADDR prompt2, sum

    call Crlf
    exit
main ENDP
END main

```

**Summary** We have shown two ways of creating multimodule programs—first, using the more conventional `EXTERN` directive, and second, using the advanced capabilities of `INVOKE`, `PROTO`, and `PROC`, in 32-bit mode. The latter directives simplify many details and are optimized for calling Windows API functions. They also hide a number of details, so you may prefer to use explicit stack parameters along with `CALL` and `EXTERN`.

### 8.5.7 Section Review

1. (*True/False*): Linking `OBJ` modules is much faster than assembling `ASM` source files.
2. (*True/False*): Separating a large program into short modules makes a program more difficult to maintain.
3. (*True/False*): In a multimodule program, an `END` statement with a label occurs only once, in the startup module.
4. (*True/False*): `PROTO` directives use up memory, so you must be careful not to include a `PROTO` directive for a procedure unless the procedure is actually called.

## 8.6 Advanced Use of Parameters (Optional Topic)

In this section, we explore some of the less commonly encountered situations when passing parameters on the runtime stack, in 32-bit mode. If you were to examine code created by C and C++ compilers, for example, you would see examples of techniques shown here.

### 8.6.1 Stack Affected by the `USES` Operator

The `USES` operator, introduced in Chapter 5, lists the names of registers to save at the beginning of a procedure and restore at the procedure's end. The assembler automatically generates appropriate `PUSH` and `POP` instructions for each named register. But there's something you have to



know: The USES operator should not be used when declaring procedures that access their stack parameters using constant offsets such as [ebp + 8]. Let's look at an example that shows why. The following **MySub1** procedure employs the USES operator to save and restore ECX and EDX:

```
MySub1 PROC USES ecx edx
    ret
MySub1 ENDP
```

The following code is generated by MASM when it assembles **MySub1**:

```
push ecx
push edx
pop  edx
pop  ecx
ret
```

Suppose we combine USES with a stack parameter, as does the following **MySub2** procedure. Its parameter is expected to be located on the stack at EBP+8:

```
MySub2 PROC USES ecx edx
    push ebp                ; save base pointer
    mov  ebp,esp            ; base of stack frame
    mov  eax,[ebp+8]        ; get the stack parameter
    pop  ebp                ; restore base pointer
    ret  4                  ; clean up the stack
MySub2 ENDP
```

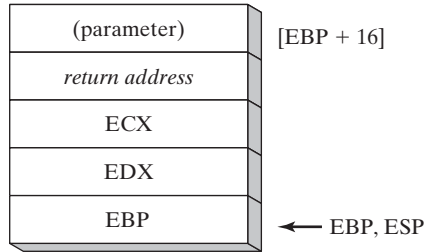
Here is the corresponding code generated by MASM for **MySub2**:

```
push ecx
push edx
push ebp
mov  ebp,esp
mov  eax,dword ptr [ebp+8] ; wrong location!
pop  ebp
pop  edx
pop  ecx
ret  4
```

An error results because the assembler inserted the PUSH instructions for ECX and EDX at the beginning of the procedure, altering the offset of the stack parameter. Figure 8-6 shows how the stack parameter must now be referenced as [EBP+16]. USES modifies the stack before saving EBP, which corrupts the standard prologue code commonly used for subroutines.

**Tip:** Earlier in this chapter, we saw that the PROC directive has a high-level syntax for declaring stack parameters. In that context, the USES operator causes no problems.

FIGURE 8–6 Stack frame of the MySub2 procedure.



### 8.6.2 Passing 8-Bit and 16-Bit Arguments on the Stack

When passing stack arguments to procedures in 32-bit mode, it's best to push 32-bit operands. Though you can push 16-bit operands on the stack, doing so prevents ESP from being aligned on a doubleword boundary. A page fault may occur and runtime performance may be degraded. You should expand them to 32 bits before pushing them on the stack. The following Uppercase procedure receives a character argument and returns its uppercase equivalent in AL:

```

Uppercase PROC
    push ebp
    mov  ebp,esp
    mov  al,[esp+8]           ; AL = character
    cmp  al,'a'              ; less than 'a'?
    jb   L1                  ; yes: do nothing
    cmp  al,'z'              ; greater than 'z'?
    ja   L1                  ; yes: do nothing
    sub  al,32                ; no: convert it
L1:
    pop  ebp
    ret  4                    ; clean up the stack
Uppercase ENDP

```

If we pass a character literal to Uppercase, the PUSH instruction automatically expands the character to 32 bits:

```

push 'x'
call Uppercase

```

Passing a character variable requires more care because the PUSH instruction does not permit 8-bit operands:

```

.data
charVal BYTE 'x'
.code
push charVal           ; syntax error!
call Uppercase

```

Instead, we use `MOVZX` to expand the character into `EAX`:

```
movzx eax,charVal           ; move with extension
push  eax
call  Uppercase
```

### 16-Bit Argument Example

Suppose we want to pass two 16-bit integers to the `AddTwo` procedure shown earlier. The procedure expects 32-bit values, so the following call would cause an error:

```
.data
word1 WORD 1234h
word2 WORD 4111h
.code
push word1
push word2
call AddTwo           ; error!
```

Instead, we can zero-extend each argument before pushing it on the stack. The following code correctly calls `AddTwo`:

```
movzx eax,word1
push  eax
movzx eax,word2
push  eax
call  AddTwo           ; sum is in EAX
```

The caller of a procedure must ensure the arguments it passes are consistent with the parameters expected by the procedure. In the case of stack parameters, the order and size of the parameters are important!

### 8.6.3 Passing 64-Bit Arguments

In 32-bit mode, when passing 64-bit integer arguments to subroutines on the stack, push the high-order doubleword of the argument first, followed by the low-order doubleword. Doing so places the integer into the stack in little-endian order (low-order byte at the lowest address). The subroutine can easily retrieve these values, as is done in the following **WriteHex64** procedure, which displays a 64-bit integer in hexadecimal:

```
WriteHex64 PROC
    push  ebp
    mov   ebp,esp
    mov   eax,[ebp+12]       ; high doubleword
    call WriteHex
    mov   eax,[ebp+8]       ; low doubleword
    call WriteHex
    pop   ebp
    ret   8
WriteHex64 ENDP
```

The following sample call to `WriteHex64` pushes the upper half of `longVal`, followed by the lower half:

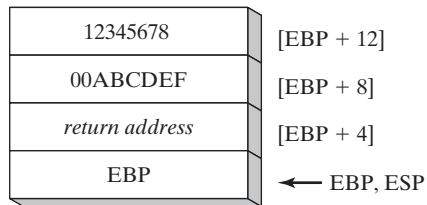
```

.data
longVal QWORD 1234567800ABCDEFh
.code
push  DWORD PTR longVal + 4    ; high doubleword
push  DWORD PTR longVal       ; low doubleword
call  WriteHex64

```

Figure 8-7 shows a picture of the stack frame inside `WriteHex64` just after `EBP` was pushed on the stack and `ESP` was copied to `EBP`.

FIGURE 8-7 Stack frame after pushing `EBP`.



### 8.6.4 Non-Doubleword Local Variables

The `LOCAL` directive has interesting behavior when you declare local variables of differing sizes. Each is allocated space according to its size: An 8-bit variable is assigned to the next available byte, a 16-bit variable is assigned to the next even address (word-aligned), and a 32-bit variable is allocated the next doubleword aligned boundary. Let's look at a few examples. First, the

**Example1** procedure contains a local variable named `var1` of type `BYTE`:

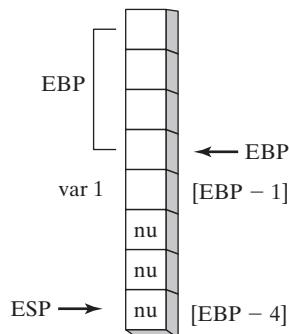
```

Example1 PROC
    LOCAL var1:byte
    mov  al,var1                ; [EBP - 1]
    ret
Example1 ENDP

```

Because stack offsets default to 32 bits in 32-bit mode, one might expect `var1` to be located at `EBP - 4`. Instead, as shown in Fig. 8-8, MASM decrements `ESP` by 4 and places `var1` at `EBP - 1`, leaving the three bytes below it unused (marked by the letters `nu`, which indicate not used). In the figure, each block represents a single byte.

FIGURE 8-8 Creating space for local variables (*Example1* Procedure).



The **Example2** procedure contains a doubleword followed by a byte:

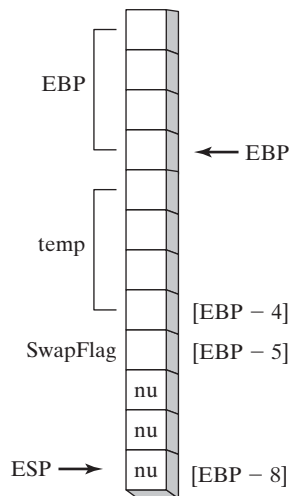
```
Example2 PROC
    local temp:dword, SwapFlag:BYTE
    .
    .
    ret
Example2 ENDP
```

The following code is generated by the assembler for **Example2**. The ADD instruction adds 8 to ESP, creating an opening in the stack between ESP and EBP for the two local variables:

```
push ebp
mov  ebp,esp
add  esp,0FFFFFFF8h      ; add -8 to ESP
mov  eax,[ebp-4]        ; temp
mov  bl,[ebp-5]         ; SwapFlag
leave
ret
```

Although **SwapFlag** is only a byte variable, ESP is rounded downward to the next doubleword stack location. A detailed view of the stack, shown as individual bytes in Fig. 8-9, shows the exact location of **SwapFlag** and the unused space below it (labeled **nu**). In the figure, each block equals a single byte.

FIGURE 8-9 Creating space in Example 2 for local variables.



If you plan to create arrays larger than a few hundred bytes as local variables, be sure to reserve adequate space for the runtime stack, using the **STACK** directive. In the Irvine32 library, for example, we reserve 4096 bytes of stack space:

```
.stack 4096
```

If procedure calls are nested, the runtime stack must be large enough to hold the sum of all local variables active at any point in the program's execution. In the following code, for example, **Sub1** calls **Sub2**, and **Sub2** calls **Sub3**. Each has a local array variable:

```
Sub1 PROC
local array1[50]:dword      ; 200 bytes
callSub2
.
.
ret
Sub1 ENDP

Sub2 PROC
local array2[80]:word      ; 160 bytes
callSub3
.
.
ret
Sub2 ENDP

Sub3 PROC
local array3[300]:dword    ; 1200 bytes
.
.
ret
Sub3 ENDP
```

When the program enters **Sub3**, the runtime stack holds local variables from **Sub1**, **Sub2**, and **Sub3**. The stack will require 1,560 bytes to hold the local variables, plus the two procedure return addresses (8 bytes), plus any registers that might have been pushed on the stack within the procedures. If a procedure is called recursively, the stack space it uses will be approximately the size of its local variables and parameters multiplied by the estimated depth of the recursion.

## 8.7 Java Bytecodes (Optional Topic)

### 8.7.1 Java Virtual Machine

The *Java Virtual Machine* (JVM) is the software that executes compiled Java bytecodes. It is an important part of the Java Platform, which encompasses programs, specifications, libraries, and data structures working together. *Java bytecodes* is the name given to the machine language inside compiled Java programs.

While this book teaches native assembly language on x86 processors, it is also instructive to learn how other machine architectures work. The JVM is the foremost example of a stack-based machine. Rather than using registers to hold operands (as the x86 does), the JVM uses a stack for data movement, arithmetic, comparison, and branching operations.

The compiled programs executed by a JVM contain *Java bytecodes*. Every Java source program must be compiled into Java bytecodes (in the form of a .class file) before it can execute. The same program containing Java bytecodes will execute on any computer system that has Java runtime software installed.

A Java source file named *Account.java*, for example, is compiled into a file named *Account.class*. Inside this class file is a stream of bytecodes for each method in the class. The JVM might optionally use a technique called *just-in-time compilation* to compile the class bytecodes into the computer's native machine language.

An executing Java method has its own stack frame containing local variables, the operand stack, input parameters, a return address, and a return value. The operand area of the stack is actually at the top of the stack, so values pushed there are available as arithmetic and logical operands, as well as arguments passed to class methods.

Before local variables can be used in instructions that involve arithmetic or comparison, they must be pushed onto the operand area of the stack frame. From this point forward, we will refer to this area as the *operand stack*.

In Java bytecodes, each instruction contains a 1-byte opcode, followed by zero or more operands. When displayed by a Java disassembler utility, the opcodes have names, such as *iload*, *istore*, *imul*, and *goto*. Each stack entry is 4 bytes (32 bits).

### Viewing Disassembled Bytecodes

The *Java Development Kit* (JDK) contains a utility named *javap.exe* that displays the byte codes in a java *.class* file. We call this a *disassembly* of the file. The command-line syntax is:

```
javap -c classname
```

For example, if your class file were named *Account.class*, the appropriate *javap* command line would be

```
javap -c Account
```

You can find the *javap.exe* utility in the *\bin* folder of your installed Java Development Kit.

## 8.7.2 Instruction Set

### Primitive Data Types

There are seven primitive data types recognized by the JVM, shown in Table 8-4. All signed integers are in two's complement format, just like x86 integers. But they are stored in big-endian order, with the high-order byte at the starting address of each integer (x86 integers are stored in little-endian order). The IEEE real formats are described in Chapter 12.

Table 8-4 Java Primitive Data Types.

| Data Type | Bytes | Format                     |
|-----------|-------|----------------------------|
| char      | 2     | Unicode character          |
| byte      | 1     | signed integer             |
| short     | 2     | signed integer             |
| int       | 4     | signed integer             |
| long      | 8     | signed integer             |
| float     | 4     | IEEE single-precision real |
| double    | 8     | IEEE double-precision real |

### Comparison Instructions

Comparison instructions pop two operands off the top of the operand stack, compare them, and push the result of the comparison back on the stack. Let's assume the operands are pushed in the following order:



The following table shows the value pushed on the stack after comparing *op1* and *op2*:

| Results of Comparing<br><i>op1</i> and <i>op2</i> | Value Pushed on the<br>Operand Stack |
|---------------------------------------------------|--------------------------------------|
| op1 > op2                                         | 1                                    |
| op1 = op2                                         | 0                                    |
| op1 < op2                                         | -1                                   |

The *dcmp* instruction compares doubles, and *fcmp* compares float values.

### Branching Instructions

Branching instructions can be categorized as either conditional branches or unconditional branches. Examples of unconditional branches in Java bytecode are *goto* and *jsr*.

The *goto* instruction unconditionally branches to a label:

```
goto label
```

The *jsr* instruction calls a subroutine identified by a label. Its syntax is:

```
jsr label
```

A conditional branch instruction usually inspects the value that it pops from the top of the operand stack. Then, based on the value, the instruction decides whether or not to branch to a given label. For example, the *ifle* instruction branches to a label if the popped value is less than or equal to zero. Its syntax is:

```
ifle label
```

Similarly, the *ifgt* instruction branches to a label if the popped value is greater than zero. Its syntax is:

```
ifgt label
```

### 8.7.3 Java Disassembly Examples

In order to help you understand how Java bytecodes work, we will present a series of short code examples written in Java. In the examples that follow, please be aware that details in the bytecode listings may vary slightly between different releases of Java.

#### Example: Adding Two Integers

The following Java source code lines add two integers and place their sum in a third variable:

```
int A = 3;
int B = 2;
int sum = 0;
sum = A + B;
```



Following is a disassembly of the Java code:

```

0:  iconst_3
1:  istore_0
2:  iconst_2
3:  istore_1
4:  iconst_0
5:  istore_2
6:  iload_0
7:  iload_1
8:  iadd
9:  istore_2

```

Each numbered line represents the byte offset of a Java bytecode instruction. In the current example, we can tell that each instruction is only one byte long because the instruction offsets are numbered consecutively.

Although bytecode disassemblies usually do not contain comments, we will add our own. Local variables have their own reserved area on the runtime stack. There is another stack called the *operand stack* that is used by instructions when performing arithmetic and moving of data. To avoid confusion between these two stacks, we will refer to variable locations with index values 0, 1, 2, and so on.

Now we will analyze the bytecodes in detail. The first two instructions push a constant value onto the operand stack and pop the same value into the local variable at location 0:

```

0:  iconst_3          // push constant (3) onto operand stack
1:  istore_0         // pop into local variable 0

```

The next four lines push two more constants on the operand stack and pop them into local variables at locations 1 and 2:

```

2:  iconst_2          // push constant (2) onto stack
3:  istore_1         // pop into local variable 1
4:  iconst_0         // push constant (0) onto stack
5:  istore_2         // pop into local variable 2

```

Having seen the Java source code from which this bytecode was generated, it is now clear that the following table shows the location indexes of the three variables:

| Location Index | Variable Name |
|----------------|---------------|
| 0              | A             |
| 1              | B             |
| 2              | sum           |

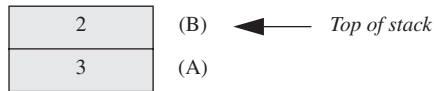
Next, in order to perform addition, the two operands must be pushed on the operand stack. The *iload\_0* instruction pushes the variable A onto the stack. The *iload\_1* instruction does the same for the variable B:

```

6:  iload_0          // push A onto the stack
7:  iload_1          // push B onto the stack

```

The operand stack now contains two values:



We are not concerned with actual machine representation in these examples, so the runtime stack is shown as growing in the upward direction. The uppermost value in each stack diagram is the top of stack.

The *iadd* instruction adds the two values at the top of the stack and pushes the sum back on the stack:

```
8: iadd
```

The operand stack contains the sum of A and B:



The *istore\_2* instruction pops the stack into location 2, which is the variable named *sum*:

```
9: istore_2
```

The operand stack is now empty.

### Example: Adding Two Doubles

The following Java snippet adds two variables of type double and saves them in a sum. It performs the same operations as our *Adding Two Integers* example, so we will focus on the differences between processing integers and doubles:

```
double A = 3.1;
double B = 2;
double sum = A + B;
```

Following are the disassembled bytecodes for our example. The comments shown at the right were inserted by the *javap* utility program:

```
0: ldc2_w #20;           // double 3.1d
3: dstore_0
4: ldc2_w #22;           // double 2.0d
7: dstore_2
8: dload_0
9: dload_2
10: dadd
11: dstore_4
```

We will discuss this code in steps. The *ldc2\_w* instruction at offset 0 pushes a floating-point constant (3.1) from the constant pool onto the operand stack. The *ldc2* instruction always includes a 2-byte index into the constant pool area:

```
0: ldc2_w #20;           // double 3.1d
```

The *dstore* instruction at offset 3 pops a double from the operand stack into the local variable at location 0. The instruction's starting offset (3) reflects the number of bytes used by the first instruction (opcode, plus 2-byte index):

```
3:  dstore_0          // save in A
```

The next two instructions at offsets 4 and 7 follow suit, initializing the variable B:

```
4:  ldc2_w #22;      // double 2.0d
7:  dstore_2          // save in B
```

The *dload\_0* and *dload\_2* instructions push the local variables onto the stack. The indexes refer to 64-bit locations (two variable stack entries) because the doubleword values are 8 bytes long:

```
8:  dload_0
9:  dload_2
```

The next instruction (*dadd*) adds the two double values at the top of the stack and pushes their sum back onto the stack:

```
10: dadd
```

The final *dstore\_4* instruction pops the stack into the local variable at location 4:

```
11: dstore_4
```

### 8.7.4 Example: Conditional Branch

An important part of understanding Java bytecodes relates to how the JVM handles conditional branching. Comparison operations always pop the top two items off the stack, compare them, and push an integer result value back onto the stack. Conditional branching instructions, which often follow comparison operations, use the integer value at the top of the stack to decide whether or not to branch to a target label. For example, the following Java code contains a simple IF statement that assigns one of two values to a boolean variable:

```
double A = 3.0;
boolean result = false;

if( A > 2.0 )
    result = false;
else
    result = true;
```

Following is the corresponding disassembly of the Java code:

```
0:  ldc2_w #26;        // double 3.0d
3:  dstore_0           // pop into A
4:  iconst_0           // false = 0
5:  istore_2           // store in result
6:  dload_0
7:  ldc2_w #22;        // double 2.0d
10: dcmpl
11: ifle 19            // if A <= 2.0, goto 19
14: iconst_0           // false
15: istore_2           // result = false
```

```

16: goto 21           // skip next two statements
19: iconst_1         // true
20: istore_2         // result = true

```

The first two instructions copy 3.0 from the constant pool onto the runtime stack, and then pop it from the stack into the variable A:

```

0:  ldc2_w #26;      // double 3.0d
3:  dstore_0         // pop into A

```

The next two instructions copy the boolean value *false* (equal to 0) from the constant area onto the stack, and then pop it into the variable named *result*:

```

4:  iconst_0         // false = 0
5:  istore_2         // store in result

```

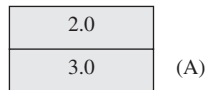
The value of A (location 0) is pushed onto the operand stack, followed by the value 2.0:

```

6:  dload_0          // push A onto the stack
7:  ldc2_w #22;      // double 2.0d

```

The operand stack now contains two values:



The *dcmpl* instruction pops two doubles from the stack and compares them. Since the value at the top of the stack (2.0) is less than the value just below it (3.0), the integer 1 is pushed on the stack.

```

10: dcmpl

```

The *ifl* instruction branches to a given offset if the value it pops from the stack is less than or equal to zero:

```

11: ifle 19           // if stack.pop() <= 0 goto 19

```

Here, we should recall that our starting Java source code example assigned a value of *false* if  $A > 2.0$ :

```

if( A > 2.0 )
    result = false;
else
    result = true;

```

The Java bytecode turns this IF statement around by jumping to offset 19 if  $A \leq 2.0$ . At offset 19, *result* is assigned the value *true*. Meanwhile, if the branch to offset 19 is not taken, *result* is assigned the value *false* by the next few instructions:

```

14: iconst_0         // false
15: istore_2         // result = false
16: goto 21         // skip next two statements

```

The *goto* instruction at offset 16 skips over the next two lines, which are responsible for assigning *true* to *result*:

```

19: iconst_1         // true
20: istore_2         // result = true

```

## Conclusion

The Java Virtual Machine has a markedly different instruction set than that of the x86 processor family. Its stack-oriented approach to calculations, comparisons, and branching contrasts sharply to the constant use of registers and memory operands in x86 instructions. While the symbolic disassembly of bytecodes is not as easy to read as x86 assembly language, bytecodes are fairly easy for the compiler to generate. Each operation is atomic, meaning that it performs just one operation. In cases where a just-in-time compiler is used by a JVM, the Java bytecodes are translated into native machine language just before execution. In this respect, Java bytecodes have a great deal in common with machine languages based on the Reduced Instruction Set (RISC) model.

## 8.8 Chapter Summary

There are two basic types of procedure parameters: register parameters and stack parameters. The Irvine32 and Irvine64 libraries use register parameters, which are optimized for program execution speed. Register parameters tend to create code clutter in calling programs. Stack parameters are the alternative. The procedure arguments must be pushed on the stack by a calling program.

A stack frame (or activation record) is the area of the stack set aside for a procedure's return address, passed parameters, local variables, and saved registers. The stack frame is created when the running program begins to execute a procedure.

When a copy of a procedure argument is pushed on the stack, it is passed by value. When an argument's address is pushed on the stack, it is passed by reference; the procedure can modify the variable via its address. Arrays should be passed by reference, to avoid having to push all array elements on the stack.

Procedure parameters can be accessed using indirect addressing with the EBP register. Expressions such as `[ebp+8]` give you a high level of control over stack parameter addressing. The LEA instruction returns the offset of any type of indirect operand. LEA is ideally suited for use with stack parameters.

The ENTER instruction completes the stack frame by saving EBP on the stack and reserving space for local variables. The LEAVE instruction terminates the stack frame for a procedure by reversing the action of a preceding ENTER instruction.

A recursive subroutine is one that calls itself, either directly or indirectly. Recursion, the practice of calling recursive subroutines, can be a powerful tool when working with data structures that have repeating patterns.

The LOCAL directive declares one or more local variables inside a procedure. It must be placed on the line immediately following a PROC directive. Local variables have distinct advantages over global variables:

- Access to the name and contents of a local variable can be restricted to its containing procedure. Local variables help when debugging programs because only a limited number of program statements are capable of modifying the local variables.

- A local variable's lifetime is limited to the execution scope of its enclosing procedure. Local variables make efficient use of memory because the same storage space can be used for other variables.
- The same variable name may be used in more than one procedure without causing a naming clash.
- Local variables can be used in recursive procedures to store values on the stack. If global variables were used instead, their values would be overwritten each time the procedure called itself.

The INVOKE directive (32-bit mode only) is a more powerful replacement for the CALL instruction that lets you pass multiple arguments. The ADDR operator can be used to pass a pointer when calling a procedure with the INVOKE directive.

The PROC directive declares a procedure name with a list of named parameters. The PROTO directive creates a prototype for an existing procedure. A prototype declares a procedure's name and parameter list.

An application program of any size is difficult to manage when all of its source code is in the same file. It is more convenient to break the program up into multiple source code files (called modules), making each file easy to view and edit.

**Java Bytecodes** *Java bytecodes* is the name given to the machine language inside compiled Java programs. The Java Virtual Machine (JVM) is the software that executes compiled Java bytecodes. In Java bytecodes, each instruction contains a 1-byte opcode, followed by zero or more operands. The JVM uses a stack-oriented model for performing arithmetic, data movement, comparison, and branching. The Java Development Kit (JDK) contains a utility named *javap.exe* that displays a disassembly of the byte codes in a java .class file.

## 8.9 Key Terms

### 8.9.1 Terms

|                                  |                            |
|----------------------------------|----------------------------|
| activation record                | operand stack              |
| argument                         | parameter                  |
| calling convention               | passing by reference       |
| effective address                | passing by value           |
| epilogue                         | procedure prototype        |
| explicit stack parameters        | prologue                   |
| Java bytecodes                   | recursion                  |
| Java Development Kit (JDK)       | recursive subroutine       |
| Java Virtual Machine (JVM)       | stack frame                |
| just-in-time compilation         | STDCALL calling convention |
| local variables                  | reference parameter        |
| memory model                     | stack parameter            |
| Microsoft x64 calling convention | subroutine                 |

## 8.9.2 Instructions, Operators, and Directives

|        |       |
|--------|-------|
| ADDR   | LOCAL |
| ENTER  | PROC  |
| INVOKE | PROTO |
| LEA    | RET   |
| LEAVE  | USES  |

## 8.10 Review Questions and Exercises

### 8.10.1 Short Answer

1. Which statements belong in a procedure's epilogue when the procedure has stack parameters and local variables?
2. When a C function returns a 32-bit integer, where is the return value stored?
3. How does a program using the STDCALL calling convention clean up the stack after a procedure call?
4. How is the LEA instruction more powerful than the OFFSET operator?
5. In the C++ example shown in Section 8.2.3, how much stack space is used by a variable of type `int`?
6. What advantages might the C calling convention have over the STDCALL calling convention?
7. (*True/False*): When using the PROC directive, all parameters must be listed on the same line.
8. (*True/False*): If you pass a variable containing the offset of an array of bytes to a procedure that expects a pointer to an array of words, the assembler will flag this as an error.
9. (*True/False*): If you pass an immediate value to a procedure that expects a reference parameter, you can generate a general-protection fault.

### 8.10.2 Algorithm Workbench

1. Here is a calling sequence for a procedure named **AddThree** that adds three doublewords (assume that the STDCALL calling convention is used):

```

push 10h
push 20h
push 30h
call AddThree

```

Draw a picture of the procedure's stack frame immediately after EBP has been pushed on the runtime stack.

2. Create a procedure named **AddThree** that receives three integer parameters and calculates and returns their sum in the EAX register.
3. Declare a local variable named **pArray** that is a pointer to an array of doublewords.
4. Declare a local variable named **buffer** that is an array of 20 bytes.

5. Declare a local variable named **pwArray** that points to a 16-bit unsigned integer.
6. Declare a local variable named **myByte** that holds an 8-bit signed integer.
7. Declare a local variable named **myArray** that is an array of 20 doublewords.
8. Create a procedure named **SetColor** that receives two stack parameters: forecolor and backcolor, and calls the `SetTextColor` procedure from the `Irvine32` library.
9. Create a procedure named **WriteColorChar** that receives three stack parameters: char, forecolor, and backcolor. It displays a single character, using the color attributes specified in forecolor and backcolor.
10. Write a procedure named `DumpMemory` that encapsulates the `DumpMem` procedure in the `Irvine32` library. Use declared parameters and the `USES` directive. The following is an example of how it should be called: `INVOKE DumpMemory, OFFSET array, LENGTHOF array, TYPE array`.
11. Declare a procedure named **MultArray** that receives two pointers to arrays of doublewords, and a third parameter indicating the number of array elements. Also, create a `PROTO` declaration for this procedure.

## 8.11 Programming Exercises

### ★ 1. FindLargest Procedure

Create a procedure named **FindLargest** that receives two parameters: a pointer to a signed doubleword array, and a count of the array's length. The procedure must return the value of the largest array member in `EAX`. Use the `PROC` directive with a parameter list when declaring the procedure. Preserve all registers (except `EAX`) that are modified by the procedure. Write a test program that calls `FindLargest` and passes three different arrays of different lengths. Be sure to include negative values in your arrays. Create a `PROTO` declaration for `FindLargest`.

### ★ 2. Chess Board

Write a program that draws an  $8 \times 8$  chess board, with alternating gray and white squares. You can use the `SetTextColor` and `Gotoxy` procedures from the `Irvine32` library. Avoid the use of global variables, and use declared parameters in all procedures. Use short procedures that are focused on a single task.

### ★★★ 3. Chess Board with Alternating Colors

This exercise extends Exercise 2. Every 500 milliseconds, change the color of the colored squares and redisplay the board. Continue until you have shown the board 16 times, using all possible 4-bit background colors. (The white squares remain white throughout.)

### ★★ 4. FindThrees Procedure

Create a procedure named **FindThrees** that returns 1 if an array has three consecutive values of 3 somewhere in the array. Otherwise, return 0. The procedure's input parameter list contains a pointer to the array and the array's size. Use the `PROC` directive with a parameter list when declaring the procedure. Preserve all registers (except `EAX`) that are modified by the procedure. Write a test program that calls `FindThrees` several times with different arrays.



**★★ 5. DifferentInputs Procedure**

Write a procedure named **DifferentInputs** that returns  $EAX = 1$  if the values of its three input parameters are all different; otherwise, return with  $EAX = 0$ . Use the **PROC** directive with a parameter list when declaring the procedure. Create a **PROTO** declaration for your procedure, and call it five times from a test program that passes different inputs.

**★★ 6. Exchanging Integers**

Create an array of randomly ordered integers. Using the **Swap** procedure from Section 8.4.6 as a tool, write a loop that exchanges each consecutive pair of integers in the array.

**★★ 7. Greatest Common Divisor**

Write a recursive implementation of Euclid's algorithm for finding the greatest common divisor (GCD) of two integers. Descriptions of this algorithm are available in algebra books and on the Web. Write a test program that calls your GCD procedure five times, using the following pairs of integers: (5,20), (24,18), (11,7), (432,226), (26,13). After each procedure call, display the GCD.

**★★ 8. Counting Matching Elements**

Write a procedure named **CountMatches** that receives pointers to two arrays of signed doublewords, and a third parameter that indicates the length of the two arrays. For each element  $x_i$  in the first array, if the corresponding  $y_i$  in the second array is equal, increment a count. At the end, return a count of the number of matching array elements in **EAX**. Write a test program that calls your procedure and passes pointers to two different pairs of arrays. Use the **INVOKE** statement to call your procedure and pass stack parameters. Create a **PROTO** declaration for **CountMatches**. Save and restore any registers (other than **EAX**) changed by your procedure.

**★★★ 9. Counting Nearly Matching Elements**

Write a procedure named **CountNearMatches** that receives pointers to two arrays of signed doublewords, a parameter that indicates the length of the two arrays, and a parameter that indicates the maximum allowed difference (called **diff**) between any two matching elements. For each element  $x_i$  in the first array, if the difference between it and the corresponding  $y_i$  in the second array is less than or equal to **diff**, increment a count. At the end, return a count of the number of nearly matching array elements in **EAX**. Write a test program that calls **CountNearMatches** and passes pointers to two different pairs of arrays. Use the **INVOKE** statement to call your procedure and pass stack parameters. Create a **PROTO** declaration for **CountMatches**. Save and restore any registers (other than **EAX**) changed by your procedure.

**★★★★ 10. Show Procedure Parameters**

Write a procedure named **ShowParams** that displays the address and hexadecimal value of the 32-bit parameters on the runtime stack of the procedure that called it. The parameters are to be displayed in order from the lowest address to the highest. Input to the procedure will be a single integer that indicates the number of parameters to display. For example, suppose the following statement in main calls **MySample**, passing three arguments:

```
INVOKE MySample, 1234h, 5000h, 6543h
```

Next, inside **MySample**, you should be able to call `ShowParams`, passing the number of parameters you want to display:

```
MySample PROC first:DWORD, second:DWORD, third:DWORD
    paramCount = 3
    call ShowParams, paramCount
```

`ShowParams` should display output in the following format:

```
Stack parameters:
-----
Address 0012FF80 = 00001234
Address 0012FF84 = 00005000
Address 0012FF88 = 00006543
```

---

# STRINGS AND ARRAYS

- 9.1 Introduction
- 9.2 String Primitive Instructions
  - 9.2.1 MOVSB, MOVSW, and MOVSD
  - 9.2.2 CMPSB, CMPSW, and CMPSD
  - 9.2.3 SCASB, SCASW, and SCASD
  - 9.2.4 STOSB, STOSW, and STOSD
  - 9.2.5 LODSB, LODSW, and LODSD
  - 9.2.6 Section Review
- 9.3 Selected String Procedures
  - 9.3.1 Str\_compare Procedure
  - 9.3.2 Str\_length Procedure
  - 9.3.3 Str\_copy Procedure
  - 9.3.4 Str\_trim Procedure
  - 9.3.5 Str\_ucase Procedure
  - 9.3.6 *String Library Demo* Program
  - 9.3.7 String Procedures in the Irvine64 Library
  - 9.3.8 Section Review
- 9.4 Two-Dimensional Arrays
  - 9.4.1 Ordering of Rows and Columns
  - 9.4.2 Base-Index Operands
  - 9.4.3 Base-Index-Displacement Operands
  - 9.4.4 Base-Index Operands in 64-Bit Mode
  - 9.4.5 Section Review
- 9.5 Searching and Sorting Integer Arrays
  - 9.5.1 Bubble Sort
  - 9.5.2 Binary Search
  - 9.5.3 Section Review
- 9.6 Java Bytecodes: String Processing (Optional Topic)
- 9.7 Chapter Summary
- 9.8 Key Terms and Instructions
- 9.9 Review Questions and Exercises
  - 9.9.1 Short Answer
  - 9.9.2 Algorithm Workbench
- 9.10 Programming Exercises

## 9.1 Introduction

If you learn to efficiently process strings and arrays, you can master the most common area of code optimization. Studies have shown that most programs spend 90% of their running time executing 10% of their code. No doubt the 10% occurs frequently in loops, and loops are required when processing strings and arrays. In this chapter, we will show techniques for string and array processing, with the goal of writing efficient code.

We will begin with the optimized string primitive instructions designed for moving, comparing, loading, and storing blocks of data. Next, we will introduce several string-handling procedures in the Irvine32 and Irvine64 libraries. Their implementations are fairly similar to the code you might see in an implementation of the standard C string library. The third part of the chapter shows how to manipulate two-dimensional arrays, using advanced indirect addressing modes: base-index and base-index-displacement. Simple indirect addressing was introduced in Section 4.4.

Section 9.5, *Searching and Sorting Integer Arrays*, is the most interesting. You will see how easy it is to implement two common elementary array processing algorithms in computer science: bubble sort and binary search. It's a great idea to study these algorithms in Java or C++, as well as assembly language.

## 9.2 String Primitive Instructions

The x86 instruction set has five groups of instructions for processing arrays of bytes, words, and doublewords. Although they are called *string primitives*, they are not limited to character arrays. In 32-bit mode, each instruction in Table 9-1 implicitly uses ESI, EDI, or both registers to address memory. References to the accumulator imply the use of AL, AX, or EAX, depending on the instruction data size. String primitives execute efficiently because they automatically repeat and increment array indexes.

Table 9-1 String Primitive Instructions.

| Instruction         | Description                                                                                       |
|---------------------|---------------------------------------------------------------------------------------------------|
| MOVSB, MOVSW, MOVSD | Move string data: Copy data from memory addressed by ESI to memory addressed by EDI.              |
| CMPSB, CMPSW, CMPSD | Compare strings: Compare the contents of two memory locations addressed by ESI and EDI.           |
| SCASB, SCASW, SCASD | Scan string: Compare the accumulator (AL, AX, or EAX) to the contents of memory addressed by EDI. |
| STOSB, STOSW, STOSD | Store string data: Store the accumulator contents into memory addressed by EDI.                   |
| LODSB, LODSW, LODSD | Load accumulator from string: Load memory addressed by ESI into the accumulator.                  |

*Using a Repeat Prefix* By itself, a string primitive instruction processes only a single memory value or pair of values. If you add a *repeat prefix*, the instruction repeats, using ECX as a counter. The repeat prefix permits you to process an entire array using a single instruction. The following repeat prefixes are used:

|              |                                                 |
|--------------|-------------------------------------------------|
| REP          | Repeat while ECX > 0                            |
| REPZ, REPE   | Repeat while the Zero flag is set and ECX > 0   |
| REPNZ, REPNE | Repeat while the Zero flag is clear and ECX > 0 |

*Example: Copy a String* In the following example, MOVSB moves 10 bytes from **string1** to **string2**. The repeat prefix first tests ECX > 0 before executing the MOVSB instruction. If ECX = 0,

the instruction is ignored and control passes to the next line in the program. If  $ECX > 0$ ,  $ECX$  is decremented and the instruction repeats:

```
cld                ; clear direction flag
mov  esi,OFFSET string1 ; ESI points to source
mov  edi,OFFSET string2 ; EDI points to target
mov  ecx,10        ; set counter to 10
rep  movsb        ; move 10 bytes
```

$ESI$  and  $EDI$  are automatically incremented when  $MOVSB$  repeats. This behavior is controlled by the CPU's Direction flag.

**Direction Flag** String primitive instructions increment or decrement  $ESI$  and  $EDI$  based on the state of the Direction flag (see Table 9-2). The Direction flag can be explicitly modified using the  $CLD$  and  $STD$  instructions:

```
CLD    ; clear Direction flag (forward direction)
STD    ; set Direction flag (reverse direction)
```

Forgetting to set the Direction flag before a string primitive instruction can be a major headache, since the  $ESI$  and  $EDI$  registers may not increment or decrement as intended.

TABLE 9-2 Direction Flag Usage in String Primitive Instructions.

| Value of the Direction Flag | Effect on $ESI$ and $EDI$ | Address Sequence |
|-----------------------------|---------------------------|------------------|
| Clear                       | Incremented               | Low-high         |
| Set                         | Decrement                 | High-low         |

### 9.2.1 $MOVSB$ , $MOVSW$ , and $MOVSD$

The  $MOVSB$ ,  $MOVSW$ , and  $MOVSD$  instructions copy data from the memory location pointed to by  $ESI$  to the memory location pointed to by  $EDI$ . The two registers are either incremented or decremented automatically (based on the value of the Direction flag):

|         |                         |
|---------|-------------------------|
| $MOVSB$ | Move (copy) bytes       |
| $MOVSW$ | Move (copy) words       |
| $MOVSD$ | Move (copy) doublewords |

You can use a repeat prefix with  $MOVSB$ ,  $MOVSW$ , and  $MOVSD$ . The Direction flag determines whether  $ESI$  and  $EDI$  will be incremented or decremented. The size of the increment/decrement is shown in the following table:

| Instruction | Value Added or Subtracted from $ESI$ and $EDI$ |
|-------------|------------------------------------------------|
| $MOVSB$     | 1                                              |
| $MOVSW$     | 2                                              |
| $MOVSD$     | 4                                              |

*Example: Copy Doubleword Array* Suppose we want to copy 20 doubleword integers from **source** to **target**. After the array is copied, ESI and EDI point one position (4 bytes) beyond the end of each array:

```
.data
source DWORD 20 DUP(0FFFFFFFFh)
target DWORD 20 DUP(?)
.code
cld                ; direction = forward
mov  ecx,LENGTHOF source ; set REP counter
mov  esi,OFFSET source  ; ESI points to source
mov  edi,OFFSET target  ; EDI points to target
rep  movsd          ; copy doublewords
```

### 9.2.2 CMPSB, CMPSW, and CMPSD

The CMPSB, CMPSW, and CMPSD instructions each compare a memory operand pointed to by ESI to a memory operand pointed to by EDI:

|       |                     |
|-------|---------------------|
| CMPSB | Compare bytes       |
| CMPSW | Compare words       |
| CMPSD | Compare doublewords |

You can use a repeat prefix with CMPSB, CMPSW, and CMPSD. The Direction flag determines the incrementing or decrementing of ESI and EDI.

*Example: Comparing Doublewords* Suppose you want to compare a pair of doublewords using CMPSD. In the following example, **source** has a smaller value than **target**, so the JA instruction will not jump to label L1.

```
.data
source DWORD 1234h
target DWORD 5678h
.code
mov  esi,OFFSET source
mov  edi,OFFSET target
cmpsd                ; compare doublewords
ja   L1              ; jump if source > target
```

To compare multiple doublewords, clear the Direction flag (forward direction), initialize ECX as a counter, and use a repeat prefix with CMPSD:

```
mov  esi,OFFSET source
mov  edi,OFFSET target
cld                ; direction = forward
mov  ecx,LENGTHOF source ; repetition counter
repe cmpsd        ; repeat while equal
```

The REPE prefix repeats the comparison, incrementing ESI and EDI automatically until ECX equals zero or a pair of doublewords is found to be different.

### 9.2.3 SCASB, SCASW, and SCASD

The SCASB, SCASW, and SCASD instructions compare a value in AL/AX/EAX to a byte, word, or doubleword, respectively, addressed by EDI. The instructions are useful when looking for a single value in a string or array. Combined with the REPE (or REPZ) prefix, the string or array is scanned while ECX > 0 and the value in AL/AX/EAX matches each subsequent value in memory. The REPNE prefix scans until either AL/AX/EAX matches a value in memory or ECX = 0.

*Scan for a Matching Character* In the following example we search the string **alpha**, looking for the letter F. If the letter is found, EDI points one position beyond the matching character. If the letter is not found, JNZ exits:

```
.data
alpha BYTE "ABCDEFGH",0
.code
mov  edi,OFFSET alpha      ; EDI points to the string
mov  al,'F'                ; search for the letter F
mov  ecx,LENGTHOF alpha   ; set the search count
cld                          ; direction = forward
repne scasb                ; repeat while not equal
jnz  quit                  ; quit if letter not found
dec  edi                    ; found: back up EDI
```

JNZ was added after the loop to test for the possibility that the loop stopped because ECX = 0 and the character in AL was not found.

### 9.2.4 STOSB, STOSW, and STOSD

The STOSB, STOSW, and STOSD instructions store the contents of AL/AX/EAX, respectively, in memory at the offset pointed to by EDI. EDI is incremented or decremented based on the state of the Direction flag. When used with the REP prefix, these instructions are useful for filling all elements of a string or array with a single value. For example, the following code initializes each byte in **string1** to 0FFh:

```
.data
Count = 100
string1 BYTE Count DUP(?)
.code
mov  al,0FFh                ; value to be stored
mov  edi,OFFSET string1     ; EDI points to target
mov  ecx,Count              ; character count
cld                          ; direction = forward
rep  stosb                  ; fill with contents of AL
```

### 9.2.5 LODSB, LODSW, and LODSD

The LODSB, LODSW, and LODSD instructions load a byte or word from memory at ESI into AL/AX/EAX, respectively. ESI is incremented or decremented based on the state of the Direction flag. The REP prefix is rarely used with LODS because each new value loaded into the accumulator overwrites its previous contents. Instead, LODS is used to load a single value. In the next example, LODSB substitutes for the following two instructions (assuming the Direction flag is clear):

```

mov al,[esi]           ; move byte into AL
inc esi               ; point to next byte

```

**Array Multiplication Example** The following program multiplies each element of a double-word array by a constant value. LODSD and STOSD work together:

```

; Multiply an Array (Mult.asm)
; This program multiplies each element of an array
; of 32-bit integers by a constant value.

INCLUDE Irvine32.inc
.data
array DWORD 1,2,3,4,5,6,7,8,9,10 ; test data
multiplier DWORD 10 ; test data
.code
main PROC
    cld ; direction = forward
    mov esi,OFFSET array ; source index
    mov edi,esi ; destination index
    mov ecx,LENGTHOF array ; loop counter
L1: lodsd ; load [ESI] into EAX
    mul multiplier ; multiply by a value
    stosd ; store EAX into [EDI]
    loop L1
    exit
main ENDP
END main

```

### 9.2.6 Section Review

1. In reference to string primitives, which 32-bit register is known as the *accumulator*?
2. Which instruction compares a 32-bit integer in the accumulator to the contents of memory, pointed to by EDI?
3. Which index register is used by the STOSD instruction?
4. Which instruction copies data from the memory location addressed by ESI into AX?
5. What does the REPZ prefix do for a CMPSB instruction?

## 9.3 Selected String Procedures

In this section, we will demonstrate several procedures from the Irvine32 library that manipulate null-terminated strings. The procedures are clearly similar to functions in the standard C library:

```

; Copy a source string to a target string.
Str_copy PROTO,
    source:PTR BYTE,
    target:PTR BYTE

; Return the length of a string (excluding the null byte) in EAX.
Str_length PROTO,
    pString:PTR BYTE

```



```

; Compare string1 to string2. Set the Zero and
; Carry flags in the same way as the CMP instruction.
Str_compare PROTO,
    string1:PTR BYTE,
    string2:PTR BYTE

; Trim a given trailing character from a string.
; The second argument is the character to trim.
Str_trim PROTO,
    pString:PTR BYTE,
    char:BYTE

; Convert a string to upper case.
Str_ucase PROTO,
    pString:PTR BYTE

```

### 9.3.1 Str\_compare Procedure

The **Str\_compare** procedure compares two strings. The calling format is

```
INVOKE Str_compare, ADDR string1, ADDR string2
```

It compares the strings in forward order, starting at the first byte. The comparison is case sensitive because ASCII codes are different for uppercase and lowercase letters. The procedure does not return a value, but the Carry and Zero flags can be interpreted as shown in Table 9-3, using the *string1* and *string2* arguments.

Table 9-3 Flags Affected by the Str\_compare Procedure.

| Relation                          | Carry Flag | Zero Flag | Branch If True |
|-----------------------------------|------------|-----------|----------------|
| <code>string1 &lt; string2</code> | 1          | 0         | JB             |
| <code>string1 = string2</code>    | 0          | 1         | JE             |
| <code>string1 &gt; string2</code> | 0          | 0         | JA             |

See Section 6.2.8 for an explanation of how CMP sets the Carry and Zero flags. The following is a listing of the **Str\_compare** procedure. See the *Compare.asm* program for a demonstration:

```

;-----
Str_compare PROC USES eax edx esi edi,
    string1:PTR BYTE,
    string2:PTR BYTE
;
; Compares two strings.
; Returns nothing, but the Zero and Carry flags are affected
; exactly as they would be by the CMP instruction.
;-----
    mov     esi,string1
    mov     edi,string2

```

```

L1: mov  al,[esi]
    mov  dl,[edi]
    cmp  al,0                ; end of string1?
    jne  L2                  ; no
    cmp  dl,0                ; yes: end of string2?
    jne  L2                  ; no
    jmp  L3                  ; yes, exit with ZF = 1

L2: inc  esi                 ; point to next
    inc  edi
    cmp  al,dl              ; characters equal?
    je   L1                  ; yes: continue loop
    ; no: exit with flags set

L3: ret
Str_compare ENDP

```

We could have used the CMPSB instruction when implementing `Str_compare`, but it would have required knowing the length of the longer string. Two calls to the `Str_length` procedure would be required. In this particular case, it is easier to check for the null terminators in both strings within the same loop. CMPSB is most effective when dealing with large strings or arrays of known length.

### 9.3.2 Str\_length Procedure

The `Str_length` procedure returns the length of a string in the EAX register. When you call it, pass the string's offset. For example:

```
INVOKE Str_length, ADDR myString
```

Here is the procedure implementation:

```

Str_length PROC USES edi,
    pString:PTR BYTE        ; pointer to string
    mov  edi,pString
    mov  eax,0              ; character count

L1: cmp  BYTE PTR[edi],0    ; end of string?
    je   L2                 ; yes: quit
    inc  edi                ; no: point to next
    inc  eax                ; add 1 to count
    jmp  L1

L2: ret
Str_length ENDP

```

See the `Length.asm` program for a demonstration of this procedure.

### 9.3.3 Str\_copy Procedure

The `Str_copy` procedure copies a null-terminated string from a source location to a target location. Before calling this procedure, you must make sure the target operand is large enough to hold the copied string. The syntax for calling `Str_copy` is

```
INVOKE Str_copy, ADDR source, ADDR target
```

No values are returned by the procedure. Here is the implementation:

```

;-----
Str_copy PROC USES eax ecx esi edi,
    source:PTR BYTE,      ; source string
    target:PTR BYTE      ; target string
;
; Copies a string from source to target.
; Requires: the target string must contain enough
;           space to hold a copy of the source string.
;-----
    INVOKE Str_length,source    ; EAX = length source
    mov    ecx,eax             ; REP count
    inc    ecx                 ; add 1 for null byte
    mov    esi,source
    mov    edi,target
    cld                       ; direction = forward
    rep    movsb               ; copy the string
    ret
Str_copy ENDP

```

See the *CopyStr.asm* program for a demonstration of this procedure.

### 9.3.4 Str\_trim Procedure

The **Str\_trim** procedure removes all occurrences of a selected trailing character from a null-terminated string. The syntax for calling it is

```
INVOKE Str_trim, ADDR string, char_to_trim
```

The logic for this procedure is interesting because you have to check a number of possible cases (shown here with # as the trailing character):

1. The string is empty.
2. The string contains other characters followed by one or more trailing characters, as in “Hello##”.
3. The string contains only one character, the trailing character, as in “#”.
4. The string contains no trailing character, as in “Hello” or “H”.
5. The string contains one or more trailing characters followed by one or more nontrailing characters, as in “#H” or “###Hello”.

You can use **Str\_trim** to remove all spaces (or any other repeated character) from the end of a string. The easiest way to truncate characters from a string is to insert a null byte just after the characters you want to retain. Any characters after the null byte become insignificant.

Table 9-4 lists some useful test cases. For each case, assuming that the # character is to be trimmed from the string, the expected output is shown.

Let’s look at some code that tests the **Str\_trim** procedure. The **INVOKE** statement passes the address of a string to **Str\_trim**:

```

.data
string_1 BYTE "Hello##",0
.code

```

```

INVOKE Str_trim,ADDR string_1,'#'
INVOKE ShowString,ADDR string_1

```

The ShowString procedure, not shown here, displays the trimmed string with brackets on either side. Here's an example of its output:

```
[Hello]
```

For more examples, see *Trim.asm* in the Chapter 9 examples. The implementation of Str\_trim, shown below, inserts a null byte just after the last character we want to keep in the string. Any characters following the null byte are universally ignored by string processing functions.

```

;-----
; Str_trim
; Remove all occurrences of a given delimiter
; character from the end of a string.
; Returns: nothing
;-----
Str_trim PROC USES eax ecx edi,
    pString:PTR BYTE,          ; points to string
    char: BYTE                 ; character to remove

    mov edi,pString           ; prepare to call Str_length
    INVOKE Str_length,edi     ; returns the length in EAX
    cmp eax,0                 ; is the length equal to zero?
    je L3                     ; yes: exit now
    mov ecx,eax               ; no: ECX = string length
    dec eax
    add edi,eax               ; point to last character

L1: mov al,[edi]              ; get a character
    cmp al,char               ; is it the delimiter?
    jne L2                    ; no: insert null byte
    dec edi                    ; yes: keep backing up
    loop L1                   ; until beginning reached

L2: mov BYTE PTR [edi+1],0    ; insert a null byte
L3: ret
Stmr_trim ENDP

```

TABLE 9-4 Testing the Str\_trim Procedure with a # Delimiter Character.

| Input String | Expected Modified String |
|--------------|--------------------------|
| "Hello##"    | "Hello"                  |
| "#"          | "" (empty string)        |
| "Hello"      | "Hello"                  |
| "H"          | "H"                      |
| "#H"         | "#H"                     |

### Detailed Description

Let us carefully examine *Str\_trim*. The algorithm starts at the end of the string and scans backwards, looking for the first nondelimiter character. When it finds one, a null byte is inserted into the string just after the character position:

```

ecx = length(str)
if length(str) > 0 then
    edi = length - 1
    do while ecx > 0
        if str[edi] ≠ delimiter then
            str[edi+1] = null
            break
        else
            edi = edi - 1
        end if
        ecx = ecx - 1
    end do

```

Next, let's look at the code implementation, line by line. First, *pString* contains the address of the string to be trimmed. We need to know the length of the string, and the *Str\_length* procedure receives its input in the EDI register:

```

mov edi,pString          ; prepare to call Str_length
INVOKE Str_length,edi    ; returns the length in EAX

```

The *Str\_length* procedure returns the length of the string in the EAX register, so the following lines compare it to zero and skip the rest of the code if the string is empty:

```

cmp  eax,0              ; is the length equal to zero?
je   L3                 ; yes: exit now

```

From this point forward, we assume that the string is not empty. ECX will be the loop counter, so it is assigned a copy of the string length. Then, since we want EDI to point to the last character in the string, EAX (containing the string length) is decreased by 1 and added to EDI:

```

mov  ecx,eax           ; no: ECX = string length
dec  eax
add  edi,eax           ; point to last character

```

With EDI now pointing at the last character in the string, we copy the character into the AL register and compare it to the delimiter character:

```

L1: mov  al,[edi]      ; get a character
     cmp  al,char      ; is it the delimiter?

```

If the character is not the delimiter, we exit the loop, knowing that a null byte will be inserted at label L2:

```

jne  L2                ; no: insert null byte

```

Otherwise, if the delimiter character is found, the loop continues to search backward through the string. This is done by moving EDI backward one position, and repeating the loop:

```

    dec  edi                ; yes: keep backing up
    loop L1                ; until beginning reached

```

If the entire string is filled with only delimiter characters, the loop will count down to zero and execution will continue on the next line after the loop. This is, of course, the code at label L2, which inserts a null byte in the string:

```

L2: mov  BYTE PTR [edi+1],0    ; insert a null byte

```

If control arrives at this point because the loop counted down to zero, EDI points one position prior to the beginning of the string. That is why the expression [edi+1] points to the first string position.

Execution reaches label L2 in two different ways: either by finding a nontrim character in the string, or by running the loop down to zero. Label L2 is followed by a RET instruction at label L3 that ends the procedure:

```

L3:  ret
Str_trim ENDP

```

### 9.3.5 Str\_ucase Procedure

The **Str\_ucase** procedure converts a string to all uppercase characters. It returns no value. When you call it, pass the offset of a string:

```

INVOKE Str_ucase, ADDR myString

```

Here is the procedure implementation:

```

;-----
; Str_ucase
; Converts a null-terminated string to uppercase.
; Returns: nothing
;-----
Str_ucase PROC USES eax esi,
pString:PTR BYTE

    mov  esi,pString
L1:  mov  al,[esi]                ; get char
     cmp  al,0                  ; end of string?
     je   L3                    ; yes: quit
     cmp  al,'a'                ; below "a"?
     jb   L2                    ;
     cmp  al,'z'                ; above "z"?
     ja   L2                    ;
     and  BYTE PTR [esi],11011111b ; convert the char
L2:  inc  esi                    ; next char
     jmp L1
L3:  ret
Str_ucase ENDP

```

(See the *Ucase.asm* program for a demonstration of this procedure.)

### 9.3.6 *String Library Demo Program*

The following 32-bit program (*StringDemo.asm*) shows examples of calling the `Str_trim`, `Str_ucase`, `Str_compare`, and `Str_length` procedures from the Irvine32 library:

```

; String Library Demo                (StringDemo.asm)
; This program demonstrates the string-handling procedures in
; the book's link library.

INCLUDE Irvine32.inc

.data
string_1 BYTE "abcde////",0
string_2 BYTE "ABCDE",0
msg0     BYTE "string_1 in upper case: ",0
msg1     BYTE "string_1 and string_2 are equal",0
msg2     BYTE "string_1 is less than string_2",0
msg3     BYTE "string_2 is less than string_1",0
msg4     BYTE "Length of string_2 is ",0
msg5     BYTE "string_1 after trimming: ",0

.code
main PROC

    call trim_string
    call upper_case
    call compare_strings
    call print_length

    exit
main ENDP

trim_string PROC
; Remove trailing characters from string_1.

    INVOKE Str_trim, ADDR string_1, '/'
    mov  edx,OFFSET msg5
    call WriteString
    mov  edx,OFFSET string_1
    call WriteString
    call Crlf

    ret
trim_string ENDP

upper_case PROC
; Convert string_1 to upper case.

    mov  edx,OFFSET msg0
    call WriteString
    INVOKE Str_ucase, ADDR string_1
    mov  edx,OFFSET string_1
    call WriteString
    call Crlf

```

```

        ret
upper_case ENDP

compare_strings PROC
; Compare string_1 to string_2.
    INVOKE Str_compare, ADDR string_1, ADDR string_2
    .IF ZERO?
    mov  edx,OFFSET msg1
    .ELSEIF CARRY?
    mov  edx,OFFSET msg2          ; string 1 is less than...
    .ELSE
    mov  edx,OFFSET msg3          ; string 2 is less than...
    .ENDIF
    call WriteString
    call Crlf

    ret
compare_strings ENDP

print_length PROC
; Display the length of string_2.
    mov  edx,OFFSET msg4
    call WriteString
    INVOKE Str_length, ADDR string_2
    call WriteDec
    call Crlf

    ret
print_length ENDP
END main

```

Trailing characters are removed from `string_1` by the call to `Str_trim`. The string is converted to upper case by calling the `Str_ucase` procedure.

*Program Output* Here is the *String Library Demo* program's output:

```

string_1 after trimming: abcde
string_1 in upper case: ABCDE
string1 and string2 are equal
Length of string_2 is 5

```

### 9.3.7 String Procedures in the Irvine64 Library

In this section, we will show how to convert a few of the more important string-handling procedures from the Irvine32 library to 64-bit mode. The changes are very simple—stack parameters are eliminated, and all 32-bit registers are replaced by 64-bit registers. Table 9-5 lists the string procedures, with descriptions of their inputs and outputs.



TABLE 9-5 String Procedures in the Irvine64 Library.

|             |                                                                                                                                                                                                                                                            |
|-------------|------------------------------------------------------------------------------------------------------------------------------------------------------------------------------------------------------------------------------------------------------------|
| Str_compare | Compares two strings<br>Input parameters: RSI points to the source string, RDI points to the target string<br>Return values: Carry flag = 1 if source < target, Zero flag = 1 if source = target, and Carry flag = 0 and Zero flag = 0 if source > target. |
| Str_copy    | Copies a source string to a location indicated by a target pointer.<br>Input parameters: RSI points to the source string, RDI points to the location where the copied string will be stored.                                                               |
| Str_length  | Returns the length of a null-terminated string<br>Input parameter: RCX points to the string<br>Return value: RAX contains the string's length                                                                                                              |

In the **Str\_compare** procedure, RSI and RDI are the logical choices for input parameters, since they are used by the string comparison loop. Using these register parameters lets us avoid copying input parameters into these registers at the beginning of the procedure:

```

; -----
; Str_compare
; Compares two strings
; Receives:  RSI points to the source string
;           RDI points to the target string
; Returns:   Sets ZF if the strings are equal
;           Sets CF if source < target
; -----
Str_compare PROC USES rax rdx rsi rdi
L1: mov  al,[rsi]
     mov  dl,[rdi]
     cmp  al,0           ; end of string1?
     jne  L2           ; no
     cmp  dl,0           ; yes: end of string2?
     jne  L2           ; no
     jmp  L3           ; yes, exit with ZF = 1
L2:  inc  rsi           ; point to next
     inc  rdi
     cmp  al,dl         ; chars equal?
     je   L1           ; yes: continue loop
                     ; no: exit with flags set
L3:  ret
Str_compare ENDP

```

Notice that the PROC directive includes the USES keyword to list all registers that must be pushed on the stack at the beginning of the procedure, and popped off the stack just before the procedure returns.

The **Str\_copy** procedure receives its string pointers in RSI and RDI:

```

; -----
; Str_copy

```

```

; Copies a string
; Receives:  RSI points to the source string
;           RDI points to the target string
; Returns:   nothing
;-----
Str_copy PROC USES rax rcx rsi rdi
    mov rcx,rsi          ; get length of source string
    call Str_length      ; returns length in RAX

    mov rcx,rax          ; loop counter
    inc rcx              ; add 1 for null byte
    cld                  ; direction = up
    rep movsb            ; copy the string
    ret
Str_copy ENDP

```

The **Str\_length** procedure receives a string pointer in RCX and loops through the string until a null byte is found. It returns the string length in RAX:

```

;-----
; Str_length
; Gets the length of a string
; Receives: RCX points to the string
; Returns:  length of string in RAX
;-----
Str_length PROC USES rdi
    mov rdi,rcx          ; get pointer
    mov eax,0            ; character count

L1:
    cmp BYTE PTR [rdi],0 ; end of string?
    je  L2               ; yes: quit
    inc rdi              ; no: point to next
    inc rax              ; add 1 to count
    jmp L1
L2: ret                  ; return count in RAX
Str_length ENDP

```

**A simple test program** The following test program calls the 64-bit Str\_length, Str\_copy, and Str\_compare procedures. Although we did not write statements to display the strings, it is a good idea to run this program in the Visual Studio debugger so you can examine the memory window, registers, and flags.

```

; Testing the Irvine64 string procedures (StringLib64Test.asm)

Str_compare    proto
Str_length     proto
Str_copy       proto
ExitProcess    proto

.data
source BYTE "ABCDEFGGAABCDFF",0      ; size = 15
target BYTE 20 dup(0)

```

```

.code
main PROC
    mov     rcx,offset source
    call   Str_length           ; returns length in RAX

    mov     rsi,offset source
    mov     rdi,offset target
    call   str_copy

; We just copied the string, so they should be equal.
    call   str_compare         ; ZF = 1, strings are equal
; Change the first character of the target string, and
; compare them again.
    mov     target,'B'
    call   str_compare         ; CF = 1, source < target

    mov     ecx,0
    call   ExitProcess

main ENDP

```

### 9.3.8 Section Review

1. (*True/False*): The **Str\_compare** procedure stops when the null terminator of the longer string is reached.
2. (*True/False*): The 32-bit **Str\_compare** procedure does not need to use ESI and EDI to access memory.
3. (*True/False*): The 32-bit **Str\_length** procedure uses SCASB to find the null terminator at the end of the string.
4. (*True/False*): The **Str\_copy** procedure prevents a string from being copied into too small a memory area.

## 9.4 Two-Dimensional Arrays

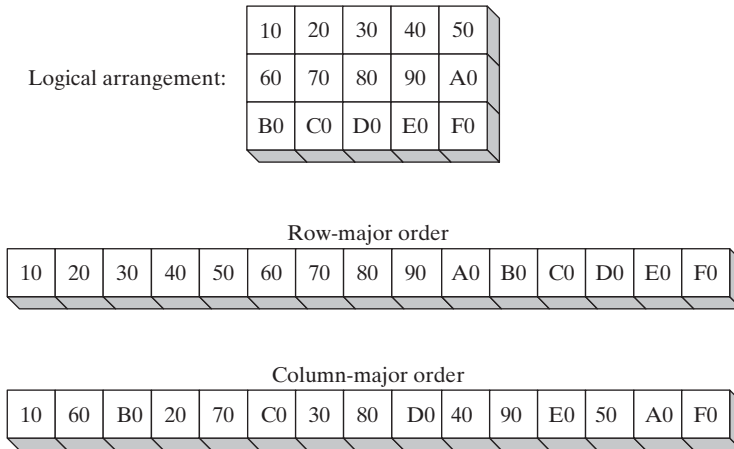
### 9.4.1 Ordering of Rows and Columns

From an assembly language programmer's perspective, a two-dimensional array is a high-level abstraction of a one-dimensional array. High-level languages select one of two methods of arranging the rows and columns in memory: *row-major order* and *column-major order*, as shown in Fig. 9-1. When row-major order (most common) is used, the first row appears at the beginning of the memory block. The last element in the first row is followed in memory by the first element of the second row. When column-major order is used, the elements in the first column appear at the beginning of the memory block. The last element in the first column is followed in memory by the first element of the second column.

If you implement a two-dimensional array in assembly language, you can choose either ordering method. In this chapter, we will use row-major order. If you write assembly language subroutines for a high-level language, you will follow the ordering specified in their documentation.

The x86 instruction set includes two operand types, base-index and base-index-displacement, both suited to array applications. We will examine both and show examples of how they can be used effectively.

FIGURE 9-1 Row-major and column-major ordering.



### 9.4.2 Base-Index Operands

A base-index operand adds the values of two registers (called *base* and *index*), producing an off-set address:

$[base + index]$

The square brackets are required. In 32-bit mode, any 32-bit general-purpose registers may be used as base and index registers. (Usually, we avoid using EBP except when addressing the stack.) The following are examples of various combinations of base and index operands in 32-bit mode:

```
.data
array WORD 1000h,2000h,3000h
.code
mov  ebx,OFFSET array
mov  esi,2
mov  ax,[ebx+esi]           ; AX = 2000h

mov  edi,OFFSET array
mov  ecx,4
mov  ax,[edi+ecx]         ; AX = 3000h

mov  ebp,OFFSET array
mov  esi,0
mov  ax,[ebp+esi]        ; AX = 1000h
```

**Two-Dimensional Array** When accessing a two-dimensional array in row-major order, the row offset is held in the base register and the column offset is in the index register. The following table, for example, has three rows and five columns:

```
tableB BYTE 10h, 20h, 30h, 40h, 50h
Rowsize = ($ - tableB)
        BYTE 60h, 70h, 80h, 90h, 0A0h
        BYTE 0B0h, 0C0h, 0D0h, 0E0h, 0F0h
```

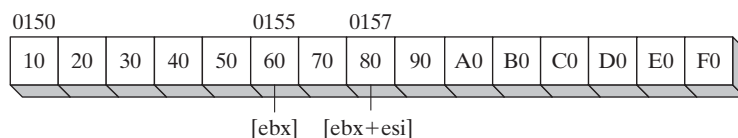
The table is in row-major order and the constant **Rowsize** is calculated by the assembler as the number of bytes in each table row. Suppose we want to locate a particular entry in the table using row and column coordinates. Assuming that the coordinates are zero based, the entry at row 1, column 2 contains 80h. We set EBX to the table's offset, add (Rowsize \* row\_index) to calculate the row offset, and set ESI to the column index:

```
row_index = 1
column_index = 2

mov ebx,OFFSET tableB      ; table offset
add ebx,RowSize * row_index ; row offset
mov esi,column_index
mov al,[ebx + esi]         ; AL = 80h
```

Suppose the array is located at offset 0150h. Then the effective address represented by EBX + ESI is 0157h. Figure 9-2 shows how adding EBX and ESI produces the offset of the byte at tableB [1, 2]. If the effective address points outside the program's data region, a runtime error occurs.

FIGURE 9-2 Addressing an array with a base-index operand.



### Calculating a Row Sum

Base index addressing simplifies many tasks associated with two-dimensional arrays. We might, for example, want to sum the elements in a row belonging to an integer matrix. The following 32-bit `calc_row_sum` procedure (see *RowSum.asm*) calculates the sum of a selected row in a matrix of 8-bit integers:

```
;-----
; calc_row_sum
; Calculates the sum of a row in a byte matrix.
; Receives: EBX = table offset, EAX = row index,
; ECX = row size, in bytes.
; Returns: EAX holds the sum.
;-----
calc_row_sum PROC USES ebx ecx edx esi

    mul    ecx                ; row index * row size
    add    ebx,eax            ; row offset
    mov    eax,0              ; accumulator
    mov    esi,0              ; column index
```

```

L1: movzx edx, BYTE PTR[ebx + esi]    ; get a byte
    add  eax, edx                    ; add to accumulator
    inc  esi                         ; next byte in row
    loop L1

    ret

calc_row_sum ENDP

```

BYTE PTR was needed to clarify the operand size in the MOVZX instruction.

### Scale Factors

If you're writing code for an array of WORD, multiply the index operand by a scale factor of 2. The following example locates the value at row 1, column 2:

```

tableW WORD    10h, 20h, 30h, 40h, 50h
RowSizeW = ($ - tableW)
        WORD    60h, 70h, 80h, 90h, 0A0h
        WORD    0B0h, 0C0h, 0D0h, 0E0h, 0F0h

.code
row_index = 1
column_index = 2
mov  ebx, OFFSET tableW          ; table offset
add  ebx, RowSizeW * row_index   ; row offset
mov  esi, column_index
mov  ax, [ebx + esi*TYPE tableW] ; AX = 0080h

```

The scale factor used in this example (TYPE tableW) is equal to 2. Similarly, you must use a scale factor of 4 if the array contains doublewords:

```

tableD DWORD 10h, 20h, ...etc.
.code
mov  eax, [ebx + esi*TYPE tableD]

```

### 9.4.3 Base-Index-Displacement Operands

A base-index-displacement operand combines a displacement, a base register, an index register, and an optional scale factor to produce an effective address. Here are the formats:

```

[base + index + displacement]
displacement[base + index]

```

*Displacement* can be the name of a variable or a constant expression. In 32-bit mode, any general-purpose 32-bit registers may be used for the base and index. Base-index-displacement operands are well suited to processing two-dimensional arrays. The displacement can be an array name, the base operand can hold the row offset, and the index operand can hold the column offset.

**Doubleword Array Example** The following two-dimensional array holds three rows of five doublewords:

```

tableD DWORD    10h, 20h, 30h, 40h, 50h
RowSize = ($ - tableD)
        DWORD    60h, 70h, 80h, 90h, 0A0h
        DWORD    0B0h, 0C0h, 0D0h, 0E0h, 0F0h

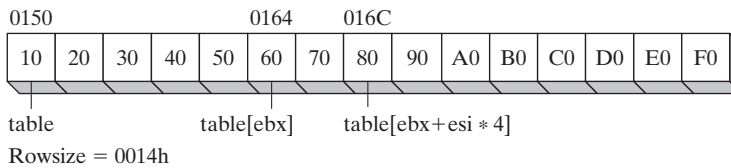
```

Rowsize is equal to 20 (14h). Assuming that the coordinates are zero based, the entry at row 1, column 2 contains 80h. To access this entry, we set EBX to the row index and ESI to the column index:

```
mov  ebx,Rowsize           ; row index
mov  esi,2                 ; column index
mov  eax,tableD[ebx + esi*TYPE tableD]
```

Suppose **tableD** begins at offset 0150h. Figure 9-3 shows the positions of EBX and ESI relative to the array. Offsets are in hexadecimal.

FIGURE 9-3 Base-index-displacement example.



#### 9.4.4 Base-Index Operands in 64-Bit Mode

In 64-bit mode, operands that use register indexes must use 64-bit registers. You can use both base-index operands and base-index-displacement operands.

Following is a short program that uses a procedure named **get\_tableVal** to locate a value in a two-dimensional table of 64-bit integers. If you compare it to the 32-bit code in the previous section, notice that ESI has been changed to RSI, and EAX and EBX are now RAX and RBX.

```
; Two-dimensional arrays in 64-bit mode (TwoDimArrays.asm)

Crlf          proto
WriteInt64    proto
ExitProcess   proto

.data
table QWORD 1,2,3,4,5
RowSize = ($ - table)
         QWORD 6,7,8,9,10
         QWORD 11,12,13,14,15

.code
main PROC
; base-index-displacement operands

mov  rax,1           ; row index (zero-based)
mov  rsi,4           ; column index (zero based)
call get_tableVal    ; returns the value in RAX
call WriteInt64      ; and display it
call Crlf

mov  ecx,0           ; end program
call ExitProcess

main ENDP
```

```

;-----
; get_tableVal
; Returns the array value at a given row and column
; in a two-dimensional array of quadwords.
; Receives: RAX = row number, RSI = column number
; Returns:  value in RAX
;-----
get_tableVal PROC USES rbx
    mov     rbx,RowSize
    mul     rbx                ; product(low) = RAX
    mov     rax,table[rax + rsi*TYPE table]
    ret
get_tableVal ENDP
end

```

### 9.4.5 Section Review

1. In 32-bit mode, which registers can be used in a base-index operand?
2. Suppose a two-dimensional array of doublewords has three logical rows and four logical columns. If ESI is used as the row index, what value is added to ESI to move from one row to the next?
3. In 32-bit mode, should you use EBP to address an array?

## 9.5 Searching and Sorting Integer Arrays

A great deal of time and energy has been expended by computer scientists in finding better ways to search and sort massive data sets. It has been proven that choosing the best algorithm for a particular application is far more useful than buying a faster computer. Most students study searching and sorting using high-level languages such as C++ and Java. Assembly language lends a different perspective to the study of algorithms by letting you see low-level implementation details.

Searching and sorting gives you a chance to try out the addressing modes introduced in this chapter. In particular, base-indexed addressing turns out to be useful because you can point one register (such as EBX) to the base of an array and use another register (such as ESI) to index into any other array location.

### 9.5.1 Bubble Sort

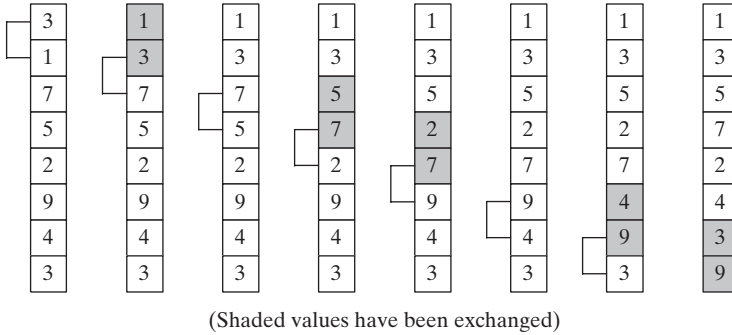
A bubble sort compares pairs of array values, beginning in positions 0 and 1. If the compared values are in reverse order, they are exchanged. Figure 9-4 shows the progress of one pass through an integer array.

After one pass, the array is still not sorted, but the largest value is now in the highest index position. The outer loop starts another pass through the array. After  $n - 1$  passes, the array is guaranteed to be sorted.

The bubble sort works well for small arrays, but it becomes tremendously inefficient for larger ones. When computer scientists measure the relative efficiency of an algorithm, they often use what is known as “big-O” notation that describes how the average running time increases in relation to increases in the number of items to be processed. The bubble sort is known as an



FIGURE 9-4 First pass through an array (bubble sort).



$O(n^2)$  algorithm, meaning that its running time increases quadratically in relation to the number of array elements ( $n$ ). Suppose, for example, that it takes 0.1 second to sort 1000 elements. As the number of elements increases by a factor of 10, the time required to sort the array increases by a factor of  $10^2$  (100). The following table shows sort times for various array sizes, assuming that 1000 array elements can be sorted in 0.1 second:

| Array Size | Time (seconds)        |
|------------|-----------------------|
| 1,000      | 0.1                   |
| 10,000     | 10.0                  |
| 100,000    | 1000                  |
| 1,000,000  | 100,000 (27.78 hours) |

A bubble sort would not be effective for an array of 1 million integers because it would take too long to finish! But it would be efficient enough to process a few hundred integers.

**Pseudocode** It's useful to create a simplified version of the bubble sort, using pseudocode that is similar to assembly language. We will use **N** to represent the size of the array, **cx1** to represent the outer loop counter, and **cx2** to represent the inner loop counter:

```

cx1 = N - 1
while( cx1 > 0 )
{
  esi = addr(array)
  cx2 = cx1
  while( cx2 > 0 )
  {
    if( array[esi] > array[esi+4] )
      exchange( array[esi], array[esi+4] )
    add esi, 4
    dec cx2
  }
  dec cx1
}

```

Mechanical concerns, such as saving and restoring the outer loop counter, have purposely been left out. Note that the inner loop count (**cx2**) is based on the current value of the outer loop count (**cx1**), which in turn decreases with each pass through the array.

**Assembly Language** From pseudocode, we can easily generate a matching implementation in assembly language, placing it in a procedure with parameters and local variables:

```

;-----
; BubbleSort
; Sort an array of 32-bit signed integers in ascending
; order, using the bubble sort algorithm.
; Receives: pointer to array, array size
; Returns: nothing
;-----
BubbleSort PROC USES eax ecx esi,
    pArray:PTR DWORD,      ; pointer to array
    Count:DWORD           ; array size

    mov  ecx,Count
    dec  ecx                ; decrement count by 1

L1:  push ecx              ; save outer loop count
     mov  esi,pArray      ; point to first value

L2:  mov  eax,[esi]       ; get array value
     cmp  [esi+4],eax     ; compare a pair of values
     jg  L3              ; if [ESI] <= [ESI+4], no exchange
     xchg eax,[esi+4]    ; exchange the pair
     mov  [esi],eax

L3:  add  esi,4          ; move both pointers forward
     loop L2            ; inner loop

     pop  ecx            ; retrieve outer loop count
     loop L1            ; else repeat outer loop

L4:  ret
BubbleSort ENDP

```

### 9.5.2 Binary Search

Array searches are some of the most common operations in everyday programming. For a small array (1000 elements or less), it's easy to do a *sequential search*, where you start at the beginning of the array and examine each element in sequence until a matching one is found. For any array of  $n$  elements, a sequential search requires an average of  $n/2$  comparisons. If a small array is searched, the execution time is minimal. On the other hand, searching an array of 1 million elements can require a more significant amount of processing time.

The *binary search* algorithm is particularly effective when searching for a single item in a large array. It has one important precondition: The array elements must be arranged in ascending or descending order. The following algorithm assumes the elements are in ascending order:

Before beginning the search, ask the user to enter an integer, which we will call *searchVal*.

1. The range of the array to be searched is indicated by the subscripts named *first* and *last*. If *first* > *last*, exit the search, indicating failure to find a match.
2. Calculate the midpoint of the array between array subscripts *first* and *last*.
3. Compare *searchVal* to the integer at the midpoint of the array:
  - If the values are equal, return from the procedure with the midpoint in EAX. This return value indicates that a match has been found in the array.
  - On the other hand, if *searchVal* is larger than the number at the midpoint, reset *first* to one position higher than the midpoint.
  - Or, if *searchVal* is smaller than the number at the midpoint, reset *last* to one position below the midpoint.
4. Return to Step 1.

The binary search algorithm is spectacularly efficient because it uses a divide and conquer strategy. The range of values is divided in half with each iteration of the loop. In general, it is described as an  $O(\log n)$  algorithm, meaning that as the number of array elements increases by a factor of  $n$ , the average search time increases by only a factor of  $\log_2 n$ . To help you get a feel for how efficient the binary search is, Table 9-6 lists the maximum number of comparisons that would be required to perform both a sequential search and a binary search on arrays of several sample sizes. These numbers represent a worst-case scenario—in actual practice, matching values might be found after fewer comparisons.

Table 9-6 Maximum Comparisons for Sequential and Binary Search.

| Array Size     | Sequential Search | Binary Search |
|----------------|-------------------|---------------|
| 64             | 64                | 6             |
| 1,024          | 1,024             | 10            |
| 65,536         | 65,536            | 17            |
| 1,048,576      | 1,048,576         | 21            |
| 4,294, 967,296 | 4,294, 967,296    | 33            |

Following is a C++ implementation of a binary search function designed to work with an array of signed integers:

```
int BinSearch( int values[], const int searchVal, int count )
{
    int first = 0;
    int last = count - 1;

    while( first <= last )
    {
        int mid = (last + first) / 2;
        if( values[mid] < searchVal )
            first = mid + 1;
        else if( values[mid] > searchVal )
            last = mid - 1;
        else
```

```

        return mid;          // success
    }
    return -1;              // not found
}

```

The following listing shows an assembly language implementation of the sample C++ code:

```

;-----
; BinarySearch
; Searches an array of signed integers for a single value.
; Receives: Pointer to array, array size, search value.
; Returns: If a match is found, EAX = the array position of the
; matching element; otherwise, EAX = -1.
;-----
BinarySearch PROC USES ebx edx esi edi,
    pArray:PTR DWORD,          ; pointer to array
    Count:DWORD,              ; array size
    searchVal:DWORD           ; search value
    LOCAL first:DWORD,        ; first position
    last:DWORD,               ; last position
    mid:DWORD                  ; midpoint

    mov     first,0            ; first = 0
    mov     eax,Count          ; last = (count - 1)
    dec     eax
    mov     last,eax
    mov     edi,searchVal     ; EDI = searchVal
    mov     ebx,pArray        ; EBX points to the array

L1:  ; while first <= last
    mov     eax,first
    cmp     eax,last
    jg     L5                  ; exit search

; mid = (last + first) / 2
    mov     eax,last
    add     eax,first
    shr     eax,1
    mov     mid,eax

; EDX = values[mid]
    mov     esi,mid
    shl     esi,2              ; scale mid value by 4
    mov     edx,[ebx+esi]     ; EDX = values[mid]

; if ( EDX < searchval(EDI) )
    cmp     edx,edi
    jge    L2

; first = mid + 1
    mov     eax,mid
    inc     eax
    mov     first,eax
    jmp    L4

```

```

; else if( EDX > searchVal(EDI) )
L2: cmp  edx,edi          ; optional
    jle  L3
;   last = mid - 1
    mov  eax,mid
    dec  eax
    mov  last,eax
    jmp  L4

; else return mid
L3: mov  eax,mid          ; value found
    jmp  L9              ; return (mid)

L4: jmp  L1              ; continue the loop

L5: mov  eax,-1          ; search failed
L9: ret
BinarySearch ENDP

```

### Test Program

To demonstrate the bubble sort and binary search functions presented in this chapter, let's write a short test program that performs the following steps, in sequence:

- Fills an array with random integers
- Displays the array
- Sorts the array using a bubble sort
- Redisplay the array
- Asks the user to enter an integer
- Performs a binary search for the user's integer (in the array)
- Displays the results of the binary search

The individual procedures have been placed in separate source files to make it easier to locate and edit source code. Table 9-7 lists each module and its contents. Most professionally written programs are divided into separate code modules.

Table 9-7 Modules in the Bubble Sort/Binary Search Program.

| Module                | Contents                                                                                                                                                                |
|-----------------------|-------------------------------------------------------------------------------------------------------------------------------------------------------------------------|
| Binary-SearchTest.asm | Main module: Contains the main, <b>ShowResults</b> , and <b>AskForSearchVal</b> procedures. Contains the program entry point and manages the overall sequence of tasks. |
| BubbleSort.asm        | <b>BubbleSort</b> procedure: Performs a bubble sort on a 32-bit signed integer array.                                                                                   |
| BinarySearch.asm      | <b>BinarySearch</b> procedure: Performs a binary search on a 32-bit signed integer array.                                                                               |
| FillArray.asm         | <b>FillArray</b> procedure: Fills a 32-bit signed integer array with a range of random values.                                                                          |
| PrintArray.asm        | <b>PrintArray</b> procedure: Writes the contents of a 32-bit signed integer array to standard output.                                                                   |

The procedures in all modules except BinarySearchTest.asm are written in such a way that it would be easy to use them in other programs without making any modifications. This is highly

desirable because we might save time in the future by reusing existing code. The same approach is used in the Irvine32 library. Following is an include file (*BinarySearch.inc*) containing prototypes of the procedures called from the main module:

```

; BinarySearch.inc - prototypes for procedures used in
; the BubbleSort / BinarySearch program.

; Searches for an integer in an array of 32-bit signed
; integers.
BinarySearch PROTO,
    pArray:PTR DWORD,          ; pointer to array
    Count:DWORD,              ; array size
    searchVal:DWORD            ; search value

; Fills an array with 32-bit signed random integers
FillArray PROTO,
    pArray:PTR DWORD,          ; pointer to array
    Count:DWORD,              ; number of elements
    LowerRange:SDWORD,        ; lower limit of random values
    UpperRange:SDWORD         ; upper limit of random values

; Writes a 32-bit signed integer array to standard output
PrintArray PROTO,
    pArray:PTR DWORD,
    Count:DWORD

; Sorts the array in ascending order
BubbleSort PROTO,
    pArray:PTR DWORD,
    Count:DWORD

```

Following is a listing of *BinarySearchTest.asm*, the main module:

```

; Bubble Sort and Binary Search          BinarySearchTest.asm)
; Bubble sort an array of signed integers, and perform
; a binary search.
; Main module, calls BinarySearch, BubbleSort, FillArray
; and PrintArray

INCLUDE Irvine32.inc
INCLUDE BinarySearch.inc          ; procedure prototypes

LOWVAL = -5000                    ; minimum value
HIGHVAL = +5000                   ; maximum value
ARRAY_SIZE = 50                   ; size of the array

.data
array DWORD ARRAY_SIZE DUP(?)

.code
main PROC
    call Randomize

    ; Fill an array with random signed integers
    INVOKE FillArray, ADDR array, ARRAY_SIZE, LOWVAL, HIGHVAL

```

```

; Display the array
INVOKE PrintArray, ADDR array, ARRAY_SIZE
call WaitMsg

; Perform a bubble sort and redisplay the array
INVOKE BubbleSort, ADDR array, ARRAY_SIZE
INVOKE PrintArray, ADDR array, ARRAY_SIZE

; Demonstrate a binary search
call AskForSearchVal      ; returned in EAX
INVOKE BinarySearch,
    ADDR array, ARRAY_SIZE, eax
call ShowResults

    exit
main ENDP

;-----
AskForSearchVal PROC
;
; Prompt the user for a signed integer.
; Receives: nothing
; Returns: EAX = value input by user
;-----

.data
prompt BYTE "Enter a signed decimal integer "
        BYTE "in the range of -5000 to +5000 "
        BYTE "to find in the array: ",0

.code
    call Crlf
    mov  edx,OFFSET prompt
    call WriteString
    call ReadInt
    ret
AskForSearchVal ENDP

;-----
ShowResults PROC
;
; Display the resulting value from the binary search.
; Receives: EAX = position number to be displayed
; Returns: nothing
;-----

.data
msg1 BYTE "The value was not found.",0
msg2 BYTE "The value was found at position ",0

.code
.IF eax == -1
    mov  edx,OFFSET msg1
    call WriteString
.ELSE
    mov  edx,OFFSET msg2
    call WriteString

```

```

        call WriteDec
.ENDIF
        call Crlf
        call Crlf
        ret
ShowResults ENDP
END main

```

*PrintArray* Following is a listing of the module containing the PrintArray procedure:

```

; PrintArray Procedure (PrintArray.asm)
INCLUDE Irvine32.inc

.code
;-----
PrintArray PROC USES eax ecx edx esi,
    pArray:PTR DWORD,      ; pointer to array
    Count:DWORD           ; number of elements
;
; Writes an array of 32-bit signed decimal integers to
; standard output, separated by commas
; Receives: pointer to array, array size
; Returns: nothing
;-----
.data
comma BYTE ", ", 0
.code
    mov     esi,pArray
    mov     ecx,Count
    cld                                ; direction = forward
L1:  lodsd                               ; load [ESI] into EAX
    call   WriteInt                     ; send to output
    mov     edx,OFFSET comma
    call   Writestring                  ; display comma
    loop  L1
    call   Crlf
    ret
PrintArray ENDP
END

```

*FillArray* Following is a listing of the module containing the FillArray procedure:

```

; FillArray Procedure (FillArray.asm)
INCLUDE Irvine32.inc

.code
;-----
FillArray PROC USES eax edi ecx edx,
    pArray:PTR DWORD,      ; pointer to array
    Count:DWORD,          ; number of elements
    LowerRange:SDWORD,    ; lower range
    UpperRange:SDWORD     ; upper range

```



```

;
; Fills an array with a random sequence of 32-bit signed
; integers between LowerRange and (UpperRange - 1).
; Returns: nothing
;-----
    mov     edi,pArray           ; EDI points to the array
    mov     ecx,Count           ; loop counter
    mov     edx,UpperRange
    sub     edx,LowerRange      ; EDX = absolute range (0..n)
    cld                          ; clear direction flag
L1:  mov     eax,edx             ; get absolute range
     call   RandomRange
     add    eax,LowerRange      ; bias the result
     stosd ; store EAX into [edi]
     loop  L1
     ret
FillArray ENDP
END

```

### 9.5.3 Section Review

1. If an array were already in sequential order, how many times would the outer loop of the **BubbleSort** procedure in Section 9.5.1 execute?
2. In the **BubbleSort** procedure, how many times does the inner loop execute on the first pass through the array?
3. In the **BubbleSort** procedure, does the inner loop always execute the same number of times?
4. If it were found (through testing) that an array of 500 integers could be sorted in 0.5 seconds, how many seconds would it take to bubble sort an array of 5000 integers?

## 9.6 Java Bytecodes: String Processing (Optional Topic)

In Chapter 8, we introduced Java bytecodes and showed how you can disassemble java .class files into a readable bytecode format. In this section, we show how Java handles strings and methods that work on strings.

### **Example: Finding a Substring**

The following Java code defines a string variable containing an employee ID and last name. Then, it calls the substring method to place the account number in a second string variable:

```
String empInfo = "10034Smith";
String id = empInfo.substring(0,5);
```

The following bytecodes are displayed when this Java code is disassembled:

```
0: ldc #32;           // String 10034Smith
2: astore_0
3: aload_0
4: iconst_0
5: iconst_5
```

```
6: invokevirtual #34;          // Method java/lang/String.substring
9: astore_1
```

Now we will study the code in steps, adding our own comments. The *ldc* instruction loads a reference to a string literal from the constant pool onto the operand stack. Then, the *astore\_0* instruction pops the string reference from the runtime stack and stores it in the local variable named *empInfo*, at index 0 in the local variables area:

```
0: ldc #32;                    // load literal string: 10034Smith
2: astore_0                    // store into empInfo (index 0)
```

Next, the *aload\_0* instruction pushes a reference to *empinfo* onto the operand stack:

```
3: aload_0                      // load empinfo onto the stack
```

Next, before calling the *substring* method, its two arguments (0 and 5) must be pushed onto the operand stack. This is accomplished by the *iconst\_0* and *iconst\_5* instructions:

```
4: iconst_0
5: iconst_5
```

The *invokevirtual* instruction invokes the *substring* method, which has a reference ID number of 34:

```
6: invokevirtual #34;          // Method java/lang/String.substring
```

The *substring* method pops the arguments off the stack, and creates a new string and pushes the string's reference on the operand stack. The following *astore\_1* instruction stores this string into index position 1 in the local variables area. This is where the variable named *id* is located:

```
9: astore_1
```

## 9.7 Chapter Summary

String primitive instructions are optimized for high-speed memory access. They are

- MOVS: Move string data
- CMPS: Compare strings
- SCAS: Scan string
- STOS: Store string data
- LODS: Load accumulator from string

Each string primitive instruction has a suffix of B, W, or D when manipulating bytes, words, and doublewords, respectively.

The repeat prefix REP repeats a string primitive instruction with automatic incrementing or decrementing of index registers. For example, when REPNE is used with SCASB, it scans memory bytes until a value in memory pointed to by EDI matches the contents of the AL register. The Direction flag determines whether the index register is incremented or decremented during each iteration of a string primitive instruction.

Strings and arrays are practically the same. Traditionally, a string consisted of an array of single-byte ASCII values, but now strings can contain 16-bit Unicode characters. The only important difference between a string and an array is that a string is usually terminated by a single null byte (containing zero).

Array manipulation is computationally intensive because it usually involves a looping algorithm. Most programs spend 80 to 90 percent of their running time executing small fraction of their code. As a result, you can speed up your software by reducing the number and complexity of instructions inside loops. Assembly language is a great tool for code optimization because you can control every detail. You might optimize a block of code, for example, by substituting registers for memory variables. Or you might use one of the string-processing instructions shown in this chapter rather than MOV and CMP instructions.

Several useful string-processing procedures were introduced in this chapter: The **Str\_copy** procedure copies one string to another. **Str\_length** returns the length of a string. **Str\_compare** compares two strings. **Str\_trim** removes a selected character from the end of a string. **Str\_ucase** converts a string to uppercase letters.

Base-index operands assist in manipulating two-dimensional arrays (tables). You can set a base register to the address of a table row, and point an index register to the offset of a column within the selected row. In 32-bit mode, any general-purpose 32-bit registers can be used as base and index registers. Base-index-displacement operands are similar to base-index operands, except that they also include the name of the array:

```
[ebx + esi]           ; base-index
array[ebx + esi]     ; base-index-displacement
```

We presented assembly language implementations of a bubble sort and a binary search. A bubble sort orders the elements of an array in ascending or descending order. It is effective for arrays having no more than a few hundred elements, but inefficient for larger arrays. A binary search permits rapid searching for a single value in an ordered array. It is easy to implement in assembly language.

## 9.8 Key Terms and Instructions

|                                  |                               |
|----------------------------------|-------------------------------|
| base-index operands              | MOVSB, MOVSD, MOVSW           |
| base-index-displacement operands | REP, REPE, REPNE, REPNZ, REPZ |
| CMPSB, CMPSW, CMPSD              | repeat prefix                 |
| column-major order               | row-major order               |
| Direction flag                   | SCASB, SCASD, SCASW           |
| Java bytecodes                   | STOSB, STOSW, STOSD           |
| LODSB, LODSW, LODSD              | string primitives             |

## 9.9 Review Questions and Exercises

### 9.9.1 Short Answer

1. Which Direction flag setting causes index registers to move backward through memory when executing string primitives?
2. When a repeat prefix is used with STOSW, what value is added to or subtracted from the index register?
3. In what way is the CMPS instruction ambiguous?

4. When the Direction flag is clear and SCASB has found a matching character, where does EDI point?
5. When scanning an array for the first occurrence of a particular character, which repeat prefix would be best?
6. What Direction flag setting is used in the Str\_trim procedure from Section 9.3?
7. Why does the Str\_trim procedure from Section 9.3 use the JNE instruction?
8. What happens in the Str\_ucase procedure from Section 9.3 if the target string contains a digit?
9. If the Str\_length procedure from Section 9.3 used SCASB, which repeat prefix would be most appropriate?
10. If the Str\_length procedure from Section 9.3 used SCASB, how would it calculate and return the string length?
11. What is the maximum number of comparisons needed by the binary search algorithm when an array contains 1,024 elements?
12. In the FillArray procedure from the Binary Search example in Section 9.5, why must the Direction flag be cleared by the CLD instruction?
13. In the BinarySearch procedure from Section 9.5, why could the statement at label L2 be removed without affecting the outcome?
14. In the BinarySearch procedure from Section 9.5, how might the statement at label L4 be eliminated?

### 9.9.2 Algorithm Workbench

1. Show an example of a base-index operand in 32-bit mode.
2. Show an example of a base-index-displacement operand in 32-bit mode.
3. Suppose a two-dimensional array of doublewords has three logical rows and four logical columns. Write an expression using ESI and EDI that addresses the third column in the second row. (Numbering for rows and columns starts at zero.)
4. Write instructions using CMPSW that compare two arrays of 16-bit values named **sourcew** and **targetw**.
5. Write instructions that use SCASW to scan for the 16-bit value 0100h in an array named **wordArray**, and copy the offset of the matching member into the EAX register.
6. Write a sequence of instructions that use the Str\_compare procedure to determine the larger of two input strings and write it to the console window.
7. Show how to call the Str\_trim procedure and remove all trailing "@" characters from a string.
8. Show how to modify the Str\_ucase procedure from the Irvine32 library so it changes all characters to lower case.
9. Create a 64-bit version of the Str\_trim procedure.
10. Show an example of a base-index operand in 64-bit mode.

11. Assuming that EBX contains a row index into a two-dimensional array of 32-bit integers named **myArray** and EDI contains the index of a column, write a single statement that moves the content of the given array element into the EAX register.
12. Assuming that RBX contains a row index into a two-dimensional array of 64-bit integers named **myArray** and RDI contains the index of a column, write a single statement that moves the content of the given array element into the RAX register.

## 9.10 Programming Exercises

The following exercises can be done in either 32-bit mode or 64-bit mode. Each string-handling procedure assumes the use of null-terminated strings. Even when not explicitly requested, write a short driver program for each exercise solution that tests your new procedure.

### ★ 1. Improved Str\_copy Procedure

The **Str\_copy** procedure shown in this chapter does not limit the number of characters to be copied. Create a new version (named **Str\_copyN**) that receives an additional input parameter indicating the maximum number of characters to be copied.

### ★★ 2. Str\_concat Procedure

Write a procedure named **Str\_concat** that concatenates a source string to the end of a target string. Sufficient space must exist in the target string to accommodate the new characters. Pass pointers to the source and target strings. Here is a sample call:

```
.data
targetStr BYTE "ABCDE",10 DUP(0)
sourceStr  BYTE "FGH",0
.code
INVOKE Str_concat, ADDR targetStr, ADDR sourceStr
```

### ★★ 3. Str\_remove Procedure

Write a procedure named **Str\_remove** that removes *n* characters from a string. Pass a pointer to the position in the string where the characters are to be removed. Pass an integer specifying the number of characters to remove. The following code, for example, shows how to remove “xxxx” from **target**:

```
.data
target  BYTE "abcxxxxdefghijklmop",0
.code
INVOKE Str_remove, ADDR [target+3], 4
```

### ★★★ 4. Str\_find Procedure

Write a procedure named **Str\_find** that searches for the first matching occurrence of a source string inside a target string and returns the matching position. The input parameters should be a pointer to the source string and a pointer to the target string. If a match is found, the procedure sets the Zero flag and EAX points to the matching position in the target string. Otherwise, the Zero flag is clear and EAX is undefined. The following code, for example, searches for “ABC” and returns with EAX pointing to the “A” in the target string:

```

.data
target BYTE "123ABC342432",0
source BYTE "ABC",0
pos     DWORD ?
.code
INVOKE Str_find, ADDR source, ADDR target
jnz notFound
mov pos,eax           ; store the position value

```

### ★★ 5. Str\_nextWord Procedure

Write a procedure called **Str\_nextWord** that scans a string for the first occurrence of a certain delimiter character and replaces the delimiter with a null byte. There are two input parameters: a pointer to the string and the delimiter character. After the call, if the delimiter was found, the Zero flag is set and EAX contains the offset of the next character beyond the delimiter. Otherwise, the Zero flag is clear and EAX is undefined. The following example code passes the address of **target** and a comma as the delimiter:

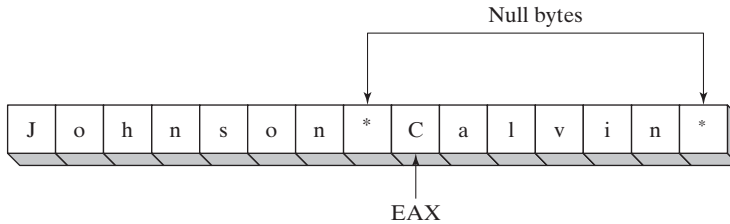
```

.data
target BYTE "Johnson,Calvin",0
.code
INVOKE Str_nextWord, ADDR target, ','
jnz notFound

```

In Figure 9-5, after calling **Str\_nextWord**, EAX points to the character following the position where the comma was found (and replaced).

FIGURE 9-5 Str\_nextWord example.



### ★★ 6. Constructing a Frequency Table

Write a procedure named **Get\_frequencies** that constructs a character frequency table. Input to the procedure should be a pointer to a string and a pointer to an array of 256 doublewords initialized to all zeros. Each array position is indexed by its corresponding ASCII code. When the procedure returns, each entry in the array contains a count of how many times the corresponding character occurred in the string. For example,

```

.data
target BYTE "AAEBDCFBBC",0
freqTable DWORD 256 DUP(0)
.code
INVOKE Get_frequencies, ADDR target, ADDR freqTable

```

Figure 9-6 shows a picture of the string and entries 41 (hexadecimal) through 4B in the frequency table. Position 41 contains the value 2 because the letter A (ASCII code 41h) occurred twice in the string. Similar counts are shown for other characters. Frequency tables are useful in data compression and other applications involving character processing. The *Huffman encoding algorithm*, for example, stores the most frequently occurring characters in fewer bits than other characters that occur less often.

FIGURE 9-6 Sample character frequency table.

|                |    |    |    |    |    |    |    |    |    |    |   |
|----------------|----|----|----|----|----|----|----|----|----|----|---|
| Target string: | A  | A  | E  | B  | D  | C  | F  | B  | B  | C  | 0 |
| ASCII code:    | 41 | 41 | 45 | 42 | 44 | 43 | 46 | 42 | 42 | 43 | 0 |

|                  |    |    |    |    |    |    |    |    |    |    |         |
|------------------|----|----|----|----|----|----|----|----|----|----|---------|
| Frequency table: | 2  | 3  | 2  | 1  | 1  | 1  | 0  | 0  | 0  | 0  | 0       |
| Index:           | 41 | 42 | 43 | 44 | 45 | 46 | 47 | 48 | 49 | 4A | 4B etc. |

### ★★★ 7. Sieve of Eratosthenes

The *Sieve of Eratosthenes*, invented by the Greek mathematician of the same name, provides a quick way to find all prime numbers within a given range. The algorithm involves creating an array of bytes in which positions are “marked” by inserting 1s in the following manner: Beginning with position 2 (which is a prime number), insert a 1 in each array position that is a multiple of 2. Then do the same thing for multiples of 3, the next prime number. Find the next prime number after 3, which is 5, and mark all positions that are multiples of 5. Proceed in this manner until all multiples of primes have been found. The remaining positions of the array that are unmarked indicate which numbers are prime. For this program, create a 65,000-element array and display all primes between 2 and 65,000. Declare the array in an uninitialized data segment (see Section 3.4.11) and use STOSB to fill it with zeros.

### ★ 8. Bubble Sort

Add a variable to the **BubbleSort** procedure in Section 9.5.1 that is set to 1 whenever a pair of values is exchanged within the inner loop. Use this variable to exit the sort before its normal completion if you discover that no exchanges took place during a complete pass through the array. (This variable is commonly known as an *exchange flag*.)

### ★★ 9. Binary Search

Rewrite the binary search procedure shown in this chapter by using registers for mid, first, and last. Add comments to clarify the registers’ usage.

### ★★★ 10. Letter Matrix

Create a procedure that generates a four-by-four matrix of randomly chosen capital letters. When choosing the letters, there must be a 50% probability that the chosen letter is a vowel. Write a test program with a loop that calls your procedure five times and displays each matrix in the console window. Following is sample output for the first three matrices:

```
D W A L
S I V W
U I O L
L A I I
```

```

K X S V
N U U O
O R Q O
A U U T

P O A Z
A E A U
G K A E
I A G D

```

### ★★★★ 11. Letter Matrix/Sets with Vowels

Use the letter matrix generated in the previous programming exercise as a starting point for this program. Generate a single random four-by-four letter matrix in which each letter has a 50% probability of being a vowel. Traverse each matrix row, column, and diagonal, generating sets of letters. Display only four-letter sets containing exactly two vowels. Suppose, for example, the following matrix was generated:

```

P O A Z
A E A U
G K A E
I A G D

```

Then the four-letter sets displayed by the program would be POAZ, GKAE, IAGD, PAGI, ZUED, PEAD, and ZAKI. The order of letters within each set is unimportant.

### ★★★★ 12. Calculating the Sum of an Array Row

Write a procedure named `calc_row_sum` that calculates the sum of a single row in a two-dimensional array of bytes, words, or doublewords. The procedure should have the following stack parameters: array offset, row size, array type, row index. It must return the sum in EAX. Use explicit stack parameters, not INVOKE or extended PROC. Write a program that tests your procedure with arrays of byte, word, and doubleword. Prompt the user for the row index, and display the sum of the selected row.

### ★★★ 13. Trimming Leading Characters

Create a variant of the `Str_trim` procedure that lets the caller remove all instances of a leading character from a string. For example, if you were to call it with a pointer to the string “###ABC” and pass it the # character, the resulting string would be “ABC.”

### ★★★ 14. Trimming a Set of Characters

Create a variant of the `Str_trim` procedure that lets the caller remove all instances of a set of characters from the end of a string. For example, if you were to call it with a pointer to the string “ABC#\$&” and pass it a pointer to an array of filter characters containing “%#!;\$&\*”, the resulting string would be “ABC”.



# STRUCTURES AND MACROS

## 10.1 Structures

- 10.1.1 Defining Structures
- 10.1.2 Declaring Structure Variables
- 10.1.3 Referencing Structure Variables
- 10.1.4 Example: Displaying the System Time
- 10.1.5 Structures Containing Structures
- 10.1.6 Example: Drunkard's Walk
- 10.1.7 Declaring and Using Unions
- 10.1.8 Section Review

## 10.2 Macros

- 10.2.1 Overview
- 10.2.2 Defining Macros
- 10.2.3 Invoking Macros
- 10.2.4 Additional Macro Features
- 10.2.5 Using the Book's Macro Library (32-Bit Mode Only)
- 10.2.6 Example Program: Wrappers
- 10.2.7 Section Review

## 10.3 Conditional-Assembly Directives

- 10.3.1 Checking for Missing Arguments
- 10.3.2 Default Argument Initializers
- 10.3.3 Boolean Expressions

- 10.3.4 IF, ELSE, and ENDIF Directives
- 10.3.5 The IFIDN and IFIDNI Directives
- 10.3.6 Example: Summing a Matrix Row
- 10.3.7 Special Operators
- 10.3.8 Macro Functions
- 10.3.9 Section Review

## 10.4 Defining Repeat Blocks

- 10.4.1 WHILE Directive
- 10.4.2 REPEAT Directive
- 10.4.3 FOR Directive
- 10.4.4 FORC Directive
- 10.4.5 Example: Linked List
- 10.4.6 Section Review

## 10.5 Chapter Summary

## 10.6 Key Terms

- 10.6.1 Terms
- 10.6.2 Operators and Directives

## 10.7 Review Questions and Exercises

- 10.7.1 Short Answer
- 10.7.2 Algorithm Workbench

## 10.8 Programming Exercises

## 10.1 Structures

A *structure* is a template or pattern given to a logically related group of variables. The variables in a structure are called *fields*. Program statements can access the structure as a single entity, or they can access individual fields. Structures often contain fields of different types. A union also groups together multiple identifiers, but the identifiers overlap the same area in memory. Unions will be covered in Section 10.1.7.

Structures provide an easy way to cluster data and pass it from one procedure to another. Suppose input parameters for a procedure consisted of 20 different units of data relating to a disk drive. Calling such a procedure would be error-prone, since one might mix up the order of arguments, or pass the incorrect number of arguments. Instead, you could place all of the input data in a structure and pass the address of the structure to the procedure. Minimal stack space would be used (one address), and the called procedure could modify the contents of the structure.

Structures in assembly language are essentially the same as structures in C and C++. With a small effort at translation, you can take any structure from the MS-Windows API library and make it work in assembly language. Most debuggers can display individual structure fields.

**COORD Structure** The COORD structure defined in the Windows API identifies X and Y screen coordinates. The field X has an offset of zero relative to the beginning of the structure, and the field Y's offset is 2:

```
COORD STRUCT
    X WORD ?           ; offset 00
    Y WORD ?           ; offset 02
COORD ENDS
```

Using a structure involves three sequential steps:

1. Define the structure.
2. Declare one or more variables of the structure type, called *structure variables*.
3. Write runtime instructions that access the structure fields.

### 10.1.1 Defining Structures

A structure is defined using the STRUCT and ENDS directives. Inside the structure, fields are defined using the same syntax as for ordinary variables. Structures can contain virtually any number of fields:

```
name STRUCT
    field-declarations
name ENDS
```

**Field Initializers** When structure fields have initializers, the values are assigned when structure variables are created. You can use various types of field initializers:

- **Undefined:** The ? operator leaves the field contents undefined.
- **String literals:** Character strings enclosed in quotation marks.
- **Integers:** Integer constants and integer expressions.
- **Arrays:** The DUP operator can initialize array elements.

The following **Employee** structure describes employee information, with fields such as ID number, last name, years of service, and an array of salary history values. The following definition must appear prior to the declaration of **Employee** variables:

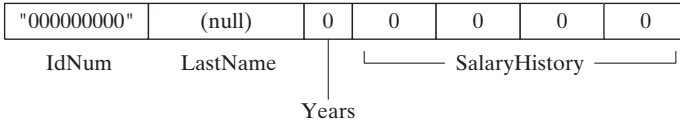
```
Employee STRUCT
    IdNum    BYTE "00000000"
    LastName BYTE 30 DUP(0)
```

```

    Years      WORD 0
    SalaryHistory DWORD 0,0,0,0
Employee ENDS

```

This is a linear representation of the structure’s memory layout:



**Aligning Structure Fields**

For best memory I/O performance, structure members should be aligned to addresses matching their data types. Otherwise, the CPU will require more time to access the members. For example, a doubleword member should be aligned on a doubleword boundary. Table 10-1 lists the alignments used by the Microsoft C and C++ compilers and by Win32 API functions. In assembly language, the ALIGN directive sets the address alignment of the next field or variable:

```
ALIGN datatype
```

The following, for example, aligns **myVar** to a doubleword boundary:

```

.data
ALIGN DWORD
myVar DWORD ?

```

Let’s correctly define the Employee structure, using ALIGN to put **Years** on a WORD boundary and **SalaryHistory** on a DWORD boundary. Field sizes appear as comments.

```

Employee STRUCT
    IdNum      BYTE "000000000"          ; 9
    LastName   BYTE 30 DUP(0)           ; 30
    ALIGN     WORD                        ; 1 byte added
    Years     WORD 0                     ; 2
    ALIGN     DWORD                       ; 2 bytes added
    SalaryHistory DWORD 0,0,0,0         ; 16
Employee ENDS                            ; 60 total

```

Table 10-1 Alignment of Structure Members.

| Member Type   | Alignment                                   |
|---------------|---------------------------------------------|
| BYTE, SBYTE   | Align on 8-bit (byte) boundary              |
| WORD, SWORD   | Align on 16-bit (word) boundary             |
| DWORD, SDWORD | Align on 32-bit (doubleword) boundary       |
| QWORD         | Align on 64-bit (quadword) boundary         |
| REAL4         | Align on 32-bit (doubleword) boundary       |
| REAL8         | Align on 64-bit (quadword) boundary         |
| structure     | Largest alignment requirement of any member |
| union         | Alignment requirement of the first member   |

### 10.1.2 Declaring Structure Variables

Structure variables can be declared and optionally initialized with specific values. This is the syntax, in which *structureType* has already been defined using the STRUCT directive:

```
identifier structureType < initializer-list >
```

The *identifier* follows the same rules as other variable names in MASM. The *initializer-list* is optional, but if used, is a comma-separated list of assembly-time constants that match the data types of specific structure fields:

```
initializer [, initializer] . . .
```

Empty angle brackets < > cause the structure to contain the default field values from the structure definition. Alternatively, you can insert new values in selected fields. The values are inserted into the structure fields in order from left to right, matching the order of the fields in the structure declaration. Examples of both approaches are shown here, using the **COORD** and **Employee** structures:

```
.data
point1 COORD <5,10>           ; X = 5, Y = 10
point2 COORD <20>             ; X = 20, Y = ?
point3 COORD <>               ; X = ?, Y = ?
worker Employee <>           ; (default initializers)
```

It is possible to override only selected field initializers. The following declaration overrides only the **IdNum** field of the **Employee** structure, assigning the remaining fields default values:

```
person1 Employee <"555223333">
```

An alternative notational form uses curly braces { . . . } rather than angle brackets:

```
person2 Employee {"555223333"}
```

When the initializer for a string field is shorter than the field, the remaining positions are padded with spaces. A null byte is not automatically inserted at the end of a string field. You can skip over structure fields by inserting commas as place markers. For example, the following statement skips the **IdNum** field and initializes the **LastName** field:

```
person3 Employee <,"dJones">
```

For an array field, use the DUP operator to initialize some or all of the array elements. If the initializer is shorter than the field, the remaining positions are filled with zeros. In the following, we initialize the first two **SalaryHistory** values and set the rest to zero:

```
person4 Employee <,, ,2 DUP(20000)>
```

**Array of Structures** Use the DUP operator to create an array of structures. In the following, the X and Y fields of each element in **AllPoints** are initialized to zeros:

```
NumPoints = 3
AllPoints COORD NumPoints DUP(<0,0>)
```

### Aligning Structure Variables

For best processor performance, align structure variables on memory boundaries equal to the largest structure member. The `Employee` structure contains `DWORD` fields, so the following definition uses that alignment:

```
.data
ALIGN DWORD
person Employee <>
```

### 10.1.3 Referencing Structure Variables

References to structure variables and structure names can be made using the `TYPE` and `SIZEOF` operators. For example, let's return to the `Employee` structure we saw earlier:

```
Employee STRUCT
    IdNum    BYTE "000000000"          ; 9
    LastName BYTE 30 DUP(0)           ; 30
    ALIGN    WORD                       ; 1 byte added
    Years    WORD 0                    ; 2
    ALIGN    DWORD                       ; 2 bytes added
    SalaryHistory DWORD 0,0,0,0       ; 16
Employee ENDS                          ; 60 total
```

Given the data definition

```
.data
worker Employee <>
```

each of the following expressions returns the same value:

```
TYPE Employee          ; 60
SIZEOF Employee        ; 60
SIZEOF worker          ; 60
```

The `TYPE` operator (Section 4.4) returns the number of bytes used by the identifier's storage type (`BYTE`, `WORD`, `DWORD`, etc.) The `LENGTHOF` operator returns a count of the number of elements in an array. The `SIZEOF` operator multiplies `LENGTHOF` by `TYPE`.

### References to Members

References to named structure members require a structure variable as a qualifier. The following constant expressions can be generated at assembly time, using the `Employee` structure:

```
TYPE Employee.SalaryHistory ; 4
LENGTHOF Employee.SalaryHistory ; 4
SIZEOF Employee.SalaryHistory ; 16
TYPE Employee.Years         ; 2
```

The following are runtime references to `worker`, an `Employee`:

```
.data
worker Employee <>
.code
mov dx,worker.Years
```

```

mov worker.SalaryHistory,20000      ; first salary
mov [worker.SalaryHistory+4],30000  ; second salary

```

*Using the OFFSET Operator* You can use the OFFSET operator to obtain the address of a field within a structure variable:

```
mov edx,OFFSET worker.LastName
```

### **Indirect and Indexed Operands**

Indirect operands permit the use of a register (such as ESI) to address structure members. Indirect addressing provides flexibility, particularly when passing a structure address to a procedure or when using an array of structures. The PTR operator is required when referencing indirect operands:

```

mov esi,OFFSET worker
mov ax,(Employee PTR [esi]).Years

```

The following statement does not assemble because **Years** by itself does not identify the structure it belongs to:

```
mov ax,[esi].Years                ; invalid
```

*Indexed Operands* We can use indexed operands to access arrays of structures. Suppose **department** is an array of five Employee objects. The following statements access the **Years** field of the employee in index position 1:

```

.data
department Employee 5 DUP(<>)
.code
mov esi,TYPE Employee          ; index = 1
mov department[esi].Years, 4

```

*Looping through an Array* A loop can be used with indirect or indexed addressing to manipulate an array of structures. The following program (*AllPoints.asm*) assigns coordinates to the **AllPoints** array:

```

; Loop Through Array                (AllPoints.asm)
INCLUDE Irvine32.inc
NumPoints = 3
.data
ALIGN WORD
AllPoints COORD NumPoints DUP(<0,0>)
.code
main PROC
    mov  edi,0                      ; array index
    mov  ecx,NumPoints              ; loop counter
    mov  ax,1                       ; starting X, Y values

L1:  mov  (COORD PTR AllPoints[edi]).X,ax
     mov  (COORD PTR AllPoints[edi]).Y,ax
     add  edi,TYPE COORD
     inc  ax
     loop L1

```

```

        exit
main ENDP
END main

```

### **Performance of Aligned Structure Members**

We have asserted that the processor can more efficiently access properly aligned structure members. How much impact do misaligned fields have on performance? Let's perform a simple test, using the two versions of the Employee structure presented in this chapter. We will rename the first version so both structures may be used in the same program:

```

EmployeeBad STRUCT
    IdNum      BYTE "000000000"
    LastName   BYTE 30 DUP(0)
    Years      WORD 0
    SalaryHistory DWORD 0,0,0,0
EmployeeBad ENDS

Employee STRUCT
    IdNum      BYTE "000000000"
    LastName   BYTE 30 DUP(0)
    ALIGN      WORD
    Years      WORD 0
    ALIGN      DWORD
    SalaryHistory DWORD 0,0,0,0
Employee ENDS

```

The following code gets the system time, executes a loop that accesses structure fields, and calculates the elapsed time. The variable `emp` can be declared as an `Employee` or `EmployeeBad` object:

```

.data
ALIGN DWORD
startTime DWORD ?           ; align startTime
emp Employee <>             ; or: emp EmployeeBad <>
.code
    call GetMSeconds        ; get starting time
    mov  startTime, eax

    mov  ecx, 0FFFFFFFFh    ; loop counter
L1:    mov  emp.Years, 5
    mov  emp.SalaryHistory, 35000
    loop L1

    call GetMSeconds        ; get starting time
    sub  eax, startTime
    call WriteDec           ; display elapsed time

```

In our simple test program (*Struct1.asm*), the execution time using the properly aligned `Employee` structure was 6141 milliseconds. The execution time when using the `EmployeeBad` structure was 6203 milliseconds. The timing difference was small (62 milliseconds), perhaps because the processor's internal memory cache minimized the alignment problems.

### 10.1.4 Example: Displaying the System Time

MS-Windows provides console functions that set the screen cursor position and get the system time. To use these functions, create instances of two predefined structures—COORD and SYSTEMTIME:

```
COORD STRUCT
    X WORD ?
    Y WORD ?
COORD ENDS

SYSTEMTIME STRUCT
    wYear WORD ?
    wMonth WORD ?
    wDayOfWeek WORD ?
    wDay WORD ?
    wHour WORD ?
    wMinute WORD ?
    wSecond WORD ?
    wMilliseconds WORD ?
SYSTEMTIME ENDS
```

Both structures are defined in *SmallWin.inc*, a file located in the assembler's INCLUDE directory and referenced by *Irvine32.inc*. To get the system time (adjusted for your local time zone), call the MS-Windows **GetLocalTime** function and pass it the address of a SYSTEMTIME structure:

```
.data
systemTime SYSTEMTIME <>
.code
INVOKE GetLocalTime, ADDR systemTime
```

Next, we retrieve the appropriate values from the SYSTEMTIME structure:

```
movzx eax,systemTime.wYear
call WriteDec
```

The *SmallWin.inc* file, located in the book's installed software folder, contains structure definitions and function prototypes adapted from the Microsoft Windows header files for C and C++ programmers. It represents a small subset of the possible functions that can be called by application programs.

When a Win32 program produces screen output, it calls the MS-Windows **GetStdHandle** function to retrieve the standard console output handle (an integer):

```
.data
consoleHandle DWORD ?
.code
INVOKE GetStdHandle, STD_OUTPUT_HANDLE
mov consoleHandle,eax
```

(The constant STD\_OUTPUT\_HANDLE is defined in *SmallWin.inc*.)



To set the cursor position, call the MS-Windows **SetConsoleCursorPosition** function, passing it the console output handle and a **COORD** structure variable containing X, Y character coordinates:

```
.data
XYPos COORD <10,5>
.code
INVOKE SetConsoleCursorPosition, consoleHandle, XYPos
```

**Program Listing** The following program (*ShowTime.asm*) retrieves the system time and displays it at a selected screen location. It runs only in protected mode:

```
; Structures (ShowTime.ASM)

INCLUDE Irvine32.inc
.data
sysTime SYSTEMTIME <>
XYPos COORD <10,5>
consoleHandle DWORD ?
colonStr BYTE ":",0
.code
main PROC
; Get the standard output handle for the Win32 Console.
INVOKE GetStdHandle, STD_OUTPUT_HANDLE
mov consoleHandle,eax

; Set the cursor position and get the system time.
INVOKE SetConsoleCursorPosition, consoleHandle, XYPos
INVOKE GetLocalTime, ADDR sysTime

; Display the system time (hh:mm:ss).
movzx eax,sysTime.wHour ; hours
call WriteDec
mov edx,OFFSET colonStr ; ":"
call WriteString
movzx eax,sysTime.wMinute ; minutes
call WriteDec
call WriteString
movzx eax,sysTime.wSecond ; seconds
call WriteDec
call Crlf
call WaitMsg ; "Press any key..."
exit
main ENDP
END main
```

The following definitions were used by this program from *SmallWin.inc* (automatically included by *Irvine32.inc*):

```
STD_OUTPUT_HANDLE EQU -11
SYSTEMTIME STRUCT ...
COORD STRUCT ...
```

```

GetStdHandle PROTO,
    nStdHandle:DWORD

GetLocalTime PROTO,
    lpSystemTime:PTR SYSTEMTIME

SetConsoleCursorPosition PROTO,
    nStdHandle:DWORD,
    coords:COORD

```

Following is a sample program output, taken at 12:16 p.m.:

```

12:16:35
Press any key to continue...

```

### 10.1.5 Structures Containing Structures

*Structures* can contain instances of other structures. For example, a **Rectangle** can be defined in terms of its upper-left and lower-right corners, both `COORD` structures:

```

Rectangle STRUCT
    UpperLeft COORD <>
    LowerRight COORD <>
Rectangle ENDS

```

Rectangle variables can be declared without overrides or by overriding individual `COORD` fields. Alternative notational forms are shown:

```

rect1 Rectangle < >
rect2 Rectangle { }
rect3 Rectangle { {10,10}, {50,20} }
rect4 Rectangle < <10,10>, <50,20> >

```

The following is a direct reference to a structure field:

```

mov rect1.UpperLeft.X, 10

```

You can access a structure field using an indirect operand. The following example moves 10 to the Y coordinate of the upper-left corner of the structure pointed to by `ESI`:

```

mov esi,OFFSET rect1
mov (Rectangle PTR [esi]).UpperLeft.Y, 10

```

The `OFFSET` operator can return pointers to individual structure fields, including nested fields:

```

mov edi,OFFSET rect2.LowerRight
mov (COORD PTR [edi]).X, 50
mov edi,OFFSET rect2.LowerRight.X
mov WORD PTR [edi], 50

```

### 10.1.6 Example: Drunkard's Walk

At this point, it might be helpful for you to see a short application that uses a structure. We will create a version of the “Drunkard’s Walk” exercise, in which the program simulates the path taken by a not-too-sober professor on his or her way home from a Computer Science holiday



```

DrunkardWalk ENDS

DisplayPosition PROTO currX:WORD, currY:WORD

.data
aWalk DrunkardWalk <>

.code
main PROC
    mov     esi,OFFSET aWalk
    call   TakeDrunkenWalk
    exit
main ENDP

;-----
TakeDrunkenWalk PROC
    LOCAL currX:WORD, currY:WORD
;
; Takes a walk in random directions (north, south, east,
; west).
; Receives: ESI points to a DrunkardWalk structure
; Returns:  the structure is initialized with random values
;-----
    pushad

; Use the OFFSET operator to obtain the address of the
; path, the array of COORD objects, and copy it to EDI.
    mov     edi,esi
    add     edi,OFFSET DrunkardWalk.path
    mov     ecx,WalkMax           ; loop counter
    mov     currX,StartX         ; current X-location
    mov     currY,StartY         ; current Y-location

Again:
    ; Insert current location in array.
    mov     ax,currX
    mov     (COORD PTR [edi]).X,ax
    mov     ax,currY
    mov     (COORD PTR [edi]).Y,ax

    INVOKE DisplayPosition, currX, currY

    mov     eax,4                 ; choose a direction (0-3)
    call   RandomRange

    .IF     eax == 0               ; North
        dec     currY
    .ELSEIF eax == 1               ; South
        inc     currY
    .ELSEIF eax == 2               ; West
        dec     currX
    .ELSE                             ; East (EAX = 3)
        inc     currX
    .ENDIF

    add     edi,TYPE COORD         ; point to next COORD
    loop   Again

```

```

Finish:
    mov (DrunkardWalk PTR [esi]).pathsUsed, WalkMax
    popad
    ret
TakeDrunkenWalk ENDP

;-----
DisplayPosition PROC currX:WORD, currY:WORD
; Display the current X and Y positions.
;-----
.data
commaStr BYTE ", ", 0
.code
    pushad
    movzx eax,currX          ; current X position
    call WriteDec
    mov  edx,OFFSET commaStr ; ", " string
    call WriteString
    movzx eax,currY          ; current Y position
    call WriteDec
    call Crlf
    popad
    ret
DisplayPosition ENDP
END main

```

*TakeDrunkenWalk Procedure* Let's take a closer look at the **TakeDrunkenWalk** procedure. It receives a pointer (ESI) to a **DrunkardWalk** structure. Using the **OFFSET** operator, it calculates the offset of the **path** array and copies it to EDI:

```

mov edi,esi
add edi,OFFSET DrunkardWalk.path

```

The initial X and Y positions (StartX and StartY) of the professor are set to 25, at the center of an imaginary 50-by-50 grid. The loop counter is initialized:

```

mov ecx, WalkMax          ; loop counter
mov currX,StartX          ; current X-location
mov currY,StartY          ; current Y-location

```

At the beginning of the loop, the first entry in the **path** array is initialized:

```

Again:
; Insert current location in array.
mov ax,currX
mov (COORD PTR [edi]).X,ax
mov ax,currY
mov (COORD PTR [edi]).Y,ax

```

At the end of the walk, a counter is inserted into the **pathsUsed** field, indicating how many steps were taken:

```
Finish:
    mov (DrunkardWalk PTR [esi]).pathsUsed, WalkMax
```

In the current version of the program, **pathsUsed** is always equal to **WalkMax**, but that could change if we checked for hazards such as lakes and buildings. Then the loop would terminate before **WalMax** was reached.

### 10.1.7 Declaring and Using Unions

Whereas each field in a structure has an offset relative to the first byte of the structure, all the fields in a *union* start at the same offset. The storage size of a union is equal to the length of its longest field. When not part of a structure, a union is declared using the **UNION** and **ENDS** directives:

```
unionname UNION
    union-fields
unionname ENDS
```

If the union is nested inside a structure, the syntax is slightly different:

```
structname STRUCT
    structure-fields
    UNION unionname
        union-fields
    ENDS
structname ENDS
```

The field declarations in a union follow the same rules as for structures, except that each field can have only a single initializer. For example, the **Integer** union has three different size attributes for the same data and initializes all fields to zero:

```
Integer UNION
    D DWORD 0
    W WORD 0
    B BYTE 0
Integer ENDS
```

*Be Consistent* Initializers, if used, should have identical values. Suppose **Integer** were declared with different initializers:

```
Integer UNION
    D DWORD 1
    W WORD 5
    B BYTE 8
Integer ENDS
```

Also, suppose we declared an **Integer** variable named **myInt** using default initializers:

```
.data
myInt Integer <>
```

As a result, values of **myInt.D**, **myInt.W**, and **myInt.B** would all equal 1. The declared initializers for fields **W** and **B** would be ignored by the assembler.

*Structure Containing a Union* You can nest a union inside a structure by using the union name in a declaration, as we have done here for the **FileID** field inside the **FileInfo** structure,

```
FileInfo STRUCT
    FileID Integer <>
    FileName BYTE 64 DUP(?)
FileInfo ENDS
```

or you can declare a union directly inside the structure, as we have done here for the **FileID** field:

```
FileInfo STRUCT
    UNION FileID
        D DWORD ?
        W WORD ?
        B BYTE ?
    ENDS
    FileName BYTE 64 DUP(?)
FileInfo ENDS
```

*Declaring and Using Union Variables* A union variable is declared and initialized in much the same way as a structure variable, with one important difference: No more than one initializer is permitted. The following are examples of Integer-type variables:

```
val1 Integer <12345678h>
val2 Integer <100h>
val3 Integer <>
```

To use a union variable in an executable instruction, you must supply the name of one of the variant fields. In the following example, we assign register values to **Integer** union fields. Note the flexibility we have in being able to use different operand sizes:

```
mov val3.B, al
mov val3.W, ax
mov val3.D, eax
```

Unions can also contain structures. The following **INPUT\_RECORD** structure is used by some MS-Windows console input functions. It contains a union named **Event**, which selects among several predefined structure types. The **EventType** field indicates which type of record appears in the union. Each structure has a different layout and size, but only one is used at a time:

```
INPUT_RECORD STRUCT
    EventType WORD ?
    ALIGN DWORD
    UNION Event
        KEY_EVENT_RECORD <>
        MOUSE_EVENT_RECORD <>
        WINDOW_BUFFER_SIZE_RECORD <>
```

```

        MENU_EVENT_RECORD <>
        FOCUS_EVENT_RECORD <>
    ENDS
INPUT_RECORD ENDS

```

The Win32 API often includes the word `RECORD` when naming structures. This is the definition of a `KEY_EVENT_RECORD` structure:

```

KEY_EVENT_RECORD STRUCT
    bKeyDown          DWORD ?
    wRepeatCount      WORD ?
    wVirtualKeyCode   WORD ?
    wVirtualScanCode WORD ?
    UNION uChar
        UnicodeChar   WORD ?
        AsciiChar     BYTE ?
    ENDS
    dwControlKeyState DWORD ?
KEY_EVENT_RECORD ENDS

```

The remaining `STRUCT` definitions from `INPUT_RECORD` can be found in the `SmallWin.inc` file.

### 10.1.8 Section Review

*Questions 1–9 refer to this structure:*

```

MyStruct STRUCT
    field1 WORD ?
    field2 DWORD 20 DUP(?)
MyStruct ENDS

```

1. Declare a **MyStruct** variable with default values.
2. Declare a **MyStruct** variable that initializes the first field to zero.
3. Declare a **MyStruct** variable and initialize the second field to an array containing all zeros.
4. Declare a variable as an array of 20 **MyStruct** objects.
5. Using the **MyStruct** array from the preceding exercise, move **field1** of the first array element to `AX`.
6. Using the **MyStruct** array from the preceding exercise, use `ESI` to index to the third array element and move `AX` to **field1**. *Hint:* Use the `PTR` operator.
7. What value does the expression `TYPE MyStruct` return?
8. What value does the expression `SIZEOF MyStruct` return?
9. Write an expression that returns the number of bytes in **field2** of **MyStruct**.

## 10.2 Macros

### 10.2.1 Overview

A *macro procedure* is a named block of assembly language statements. Once defined, it can be invoked (called) as many times in a program as you wish. When you *invoke* a macro procedure, a copy of its code is inserted directly into the program at the location where it was invoked. This



type of automatic code insertion is also known as *inline expansion*. It is customary to refer to *calling* a macro procedure, although technically there is no CALL instruction involved.

**Tip:** The term *macro procedure* is used in the Microsoft Assembler manual to identify macros that do not return a value. There are also *macro functions* that return a value. Among programmers, the word *macro* is usually understood to mean the same thing as *macro procedure*. From this point on, we will use the shorter form.

**Placement** Macro definitions usually appear at the beginning of a program's source code, or they are placed in a separate file and copied into a program by an INCLUDE directive. Macros are expanded during the assembler's *preprocessing* step. In this step, the preprocessor reads a macro definition and scans the remaining source code in the program. At every point where the macro is invoked, the assembler inserts a copy of the macro's source code into the program. A macro definition must be found by the assembler before it can assemble any invocations of the macro. If a program defines a macro but never calls it, the macro code does not appear in the compiled program.

In the following example, a macro named **PrintX** calls the **WriteChar** procedure from the Irvine32 library. This definition would normally be placed just before the data segment:

```
PrintX MACRO
    mov    al,'X'
    call  WriteChar
ENDM
```

Next, in the code segment, we call the macro:

```
.code
PrintX
```

When the preprocessor scans this program and discovers the call to **PrintX**, it replaces the macro invocation with the following statements:

```
mov    al,'X'
call  WriteChar
```

Text substitution has taken place. Although the macro is somewhat inflexible, we will soon show how to pass arguments to macros, making them far more useful.

### 10.2.2 Defining Macros

A macro is defined using the MACRO and ENDM directives. The syntax is

```
macroname MACRO parameter-1, parameter-2...
    statement-list
ENDM
```

There is no fixed rule regarding indentation, but we recommend that you indent statements between *macroname* and ENDM. You might also want to prefix macro names with the letter *m*, creating recognizable names such as **mPutChar**, **mWriteString**, and **mGotoxy**. The statements between the MACRO and ENDM directives are not assembled until the macro is invoked. There can be any number of parameters in the macro definition, separated by commas.

*Parameters* Macro parameters are named placeholders for text arguments passed to the caller. The arguments may in fact be integers, variable names, or other values, but the preprocessor treats them as text. Parameters contain no type information, so the preprocessor does not check argument types to see whether they are correct. If a type mismatch occurs, it is caught by the assembler after the macro has been expanded.

*mPutchar Example* The following **mPutchar** macro receives a single input parameter named **char** and displays it on the console by calling **WriteChar** from the book's link library:

```
mPutchar MACRO char
    push  eax
    mov   al,char
    call  WriteChar
    pop   eax
ENDM
```

### 10.2.3 Invoking Macros

A macro is invoked by inserting its name in the program, possibly followed by macro arguments. The syntax for invoking a macro is

```
macroname argument-1, argument-2, ...
```

*Macroname* must be the name of a macro defined prior to this point in the source code. Each argument is a text value that replaces a parameter in the macro. The order of arguments must correspond to the order of parameters, but the number of arguments does not have to match the number of parameters. If too many arguments are passed, the assembler issues a warning. If too few arguments are passed to a macro, the unfilled parameters are left blank.

*Invoking mPutchar* In the previous section, we defined the **mPutChar** macro. When invoking **mPutchar**, we can pass any character or ASCII code. The following statement invokes **mPutchar** and passes it the letter A:

```
mPutchar 'A'
```

The assembler's preprocessor expands the statement into the following code, shown in the listing file:

```
1  push  eax
1  mov   al,'A'
1  call  WriteChar
1  pop   eax
```

The 1 in the left column indicates the macro expansion level, which increases when you call other macros from within a macro. The following loop displays the first 20 letters of the alphabet:

```
    mov  al,'A'
    mov  ecx,20
L1:  mPutchar al          ; macro call
    inc  al
    loop L1
```

Our loop is expanded by the preprocessor into the following code (visible in the source listing file). The macro invocation is shown just before its expansion:

```

    mov  al,'A'
    mov  ecx,20
L1:  mPuchar al                ; invoke the macro
    1   push  eax
    1   mov   al,al
    1   call  WriteChar
    1   pop   eax
       inc  al
       loop L1

```

**Tip:** In general, macros execute more quickly than procedures because procedures have the extra overhead of CALL and RET instructions. There is, however, one disadvantage to using macros: repeated use of large macros tends to increase a program's size because each macro invocation inserts a new copy of the macro's code into the program.

### Debugging Macros

Debugging a program that uses macros can be a special challenge. After assembling a program, check its listing file (extension.LST) to make sure each macro is expanded the way you intended. Next, start the program in the Visual Studio debugger, right click the debugging window, and select *Go to Disassembly* from the popup menu. Each macro call is followed by the code generated by the macro. Here is an example:

```

mWriteAt 15,10,"Hi there"
    push  edx
    mov   dh,0Ah
    mov   dl,0Fh
    call  _Gotoxy@0 (401551h)
    pop   edx
    push  edx
    mov   edx,offset ??0000 (405004h)
    call  _WriteString@0 (401D64h)
    pop   edx

```

The function names begin with underscore (\_) because the Irvine32 library uses the STDCALL calling convention.

## 10.2.4 Additional Macro Features

### Required Parameters

Using the REQ qualifier, you can specify that a macro parameter is required. If the macro is invoked without an argument to match the required parameter, the assembler displays an error message. If a macro has multiple required parameters, each one must include the REQ qualifier. In the following **mPuchar** macro, the **char** parameter is required:

```

mPuchar MACRO char:REQ
    push  eax

```

```

        mov    al,char
        call  WriteChar
        pop   eax
ENDM

```

### Macro Comments

Ordinary comment lines appearing in a macro definition appear each time the macro is expanded. If you want to omit comments from macro expansions, preface them with a double semicolon (;). Here is an example:

```

mPuchar MACRO char:REQ
    push  eax                ;; reminder: char must contain 8 bits
    mov   al,char
    call  WriteChar
    pop   eax
ENDM

```

### ECHO Directive

The ECHO directive writes a string to standard output as the program is assembled. In the following version of **mPuchar**, the message “Expanding the mPuchar macro” is displayed during assembly:

```

mPuchar MACRO char:REQ
    ECHO  Expanding the mPuchar macro
    push  eax
    mov   al,char
    call  WriteChar
    pop   eax
ENDM

```

**Tip:** Visual Studio 2012’s console window does not capture output from the ECHO directive unless you configure it to generate verbose output when building your program. To do this, select *Options* from the Tools menu, select *Projects and Solutions*, select *Build and Run*, and select *Detailed* from the *MSBuild project build output verbosity* dropdown list. Alternatively, you can open a command prompt and assemble the program. First, execute this command, adjusting the path for your current version of Visual Studio:

```
"C:\Program Files\Microsoft Visual Studio 11.0\VC\bin\vcvars32"
```

Next, enter this command, where *filename.asm* is your source code filename:

```
ml.exe /c /I "c:\Irvine" filename.asm
```

### LOCAL Directive

Macro definitions often contain labels and self-reference those labels in their code. The following **makeString** macro, for example, declares a variable named **string** and initializes it with a character array:

```

makeString MACRO text
    .data
    string BYTE text,0
ENDM

```

Suppose we invoke the macro twice:

```
makeString "Hello"
makeString "Goodbye"
```

An error results because the assembler does not allow two labels to have the same name:

```
    makeString "Hello"
1   .data
1   string BYTE "Hello",0
    makeString "Goodbye"
1   .data
1   string BYTE "Goodbye",0    ; error!
```

*Using LOCAL* To avoid problems caused by label redefinitions, you can apply the `LOCAL` directive to labels inside a macro definition. When a label is marked `LOCAL`, the preprocessor converts the label's name to a unique identifier each time the macro is expanded. Here's a new version of `makeString` that uses `LOCAL`:

```
makeString MACRO text
    LOCAL string
    .data
    string BYTE text,0
ENDM
```

If we invoke the macro twice as before, the code generated by the preprocessor replaces each occurrence of `string` with a unique identifier:

```
    makeString "Hello"
1   .data
1   ??0000 BYTE "Hello",0
    makeString "Goodbye"
1   .data
1   ??0001 BYTE "Goodbye",0
```

The label names produced by the assembler take the form `??nnnn`, where `nnnn` is a unique integer. The `LOCAL` directive should also be used for code labels in macros.

### **Macros Containing Code and Data**

Macros often contain both code and data. The following `mWrite` macro, for example, displays a literal string on the console:

```
mWrite MACRO text
    LOCAL string                ;; local label
    .data
    string BYTE text,0         ;; define the string
    .code
    push  edx
    mov   edx,OFFSET string
    call WriteString
    pop   edx
ENDM
```

The following statements invoke the macro twice, passing it different string literals:

```
mWrite "Please enter your first name"
mWrite "Please enter your last name"
```

The expansion of the two statements by the assembler shows that each string is assigned a unique label, and the **MOV** instructions are adjusted accordingly:

```

    mWrite "Please enter your first name"
1   .data
1   ??0000 BYTE "Please enter your first name",0
1   .code
1   push edx
1   mov  edx,OFFSET ??0000
1   call WriteString
1   pop  edx
    mWrite "Please enter your last name"
1   .data
1   ??0001 BYTE "Please enter your last name",0
1   .code
1   push edx
1   mov  edx,OFFSET ??0001
1   call WriteString
1   pop  edx
```

### ***Nested Macros***

A macro invoked from another macro is called a *nested macro*. When the assembler's preprocessor encounters a call to a nested macro, it expands the macro in place. Parameters passed to an enclosing macro are passed directly to its nested macros.

**Tip:** Use a modular approach when creating macros. Keep them short and simple so they can be combined into more complex macros. Doing this helps to reduce the amount of duplicate code in your programs.

***mWriteLn Example*** The following **mWriteLn** macro writes a string literal to the console and appends an end of line. It invokes the **mWrite** macro and calls the **Crlf** procedure:

```
mWriteLn MACRO text
    mWrite text
    call  Crlf
ENDM
```

The **text** parameter is passed directly to **mWrite**. Suppose the following statement invokes **mWriteLn**:

```
mWriteLn "My Sample Macro Program"
```

In the resulting code expansion, the nesting level (2) next to the statements indicates a nested macro has been invoked:

```

    mWriteLn "My Sample Macro Program"
2   .data
2   ??0002 BYTE "My Sample Macro Program",0
```

```

2   .code
2   push edx
2   mov  edx,OFFSET ??0002
2   call WriteString
2   pop  edx
1   call Crlf

```

### 10.2.5 Using the Book's Macro Library (32-Bit Mode Only)

The sample programs supplied with this book include a small but useful 32-bit library, which you can enable simply by adding the following line to your programs just after the `INCLUDE` you already have:

```
INCLUDE Macros.inc
```

Some of the macros are wrappers around existing procedures in the Irvine32 library, making it easier to pass parameters. Other macros provide new functionality. Table 10-2 describes each macro in detail. The example code can be found in *MacroTest.asm*.

Table 10-2 Macros in the Macros.inc Library.

| Macro Name    | Parameters                        | Description                                                    |
|---------------|-----------------------------------|----------------------------------------------------------------|
| mDump         | varName, useLabel                 | Displays a variable, using its name and default attributes.    |
| mDumpMem      | address, itemCount, componentSize | Displays a range of memory.                                    |
| mGotoxy       | X, Y                              | Sets the cursor position in the console window buffer.         |
| mReadString   | varName                           | Reads a string from the keyboard.                              |
| mShow         | itsName, format                   | Displays a variable or register in various formats.            |
| mShowRegister | regName, regValue                 | Displays a 32-bit register's name and contents in hexadecimal. |
| mWrite        | text                              | Writes a string literal to the console window.                 |
| mWriteSpace   | count                             | Writes one or more spaces to the console window.               |
| mWriteString  | buffer                            | Writes a string variable's contents to the console window.     |

#### ***mDumpMem***

The `mDumpMem` macro displays a block of memory in the console window. Pass it a constant, register, or variable containing the offset of the memory you want displayed. The second argument should be the number of memory components to be displayed, and the third argument is the size of each memory component. (The macro invokes the `DumpMem` library procedure, assigning the three arguments to `ESI`, `ECX`, and `EBX`, respectively.) Let's assume the following data definition:

```

.data
array DWORD 1000h,2000h,3000h,4000h

```

The following statement displays the array using its default attributes:

```
mDumpMem OFFSET array, LENGTHOF array, TYPE array
```

Output:

```
Dump of offset 00405004
-----
00001000 00002000 00003000 00004000
```

The following displays the same array as a byte sequence:

```
mDumpMem OFFSET array, SIZEOF array, TYPE BYTE
```

Output:

```
Dump of offset 00405004
-----
00 10 00 00 00 20 00 00 00 30 00 00 00 40 00 00
```

The following code pushes three values on the stack, sets the values of EBX, ECX, and ESI, and uses mDumpMem to display the stack:

```
mov  eax,0AAAAAAAAh
push eax
mov  eax,0BBBBBBBBh
push eax
mov  eax,0CCCCCCCCh
push eax
mov  ebx,1
mov  ecx,2
mov  esi,3
mDumpMem esp, 8, TYPE DWORD
```

The resulting stack dump shows the macro has pushed EBX, ECX, and ESI on the stack. Following those values are the three integers we pushed on the stack before invoking mDumpMem:

```
Dump of offset 0012FFAC
-----
00000003 00000002 00000001 CCCCCCCC BBBBBBBB AAAAAAAA 7C816D4F
0000001A
```

*Implementation* Here is the macro's code listing:

```
mDumpMem MACRO address:REQ, itemCount:REQ, componentSize:REQ
;
; Displays a dump of memory, using the DumpMem procedure.
; Receives: memory offset, count of the number of items
;           to display, and the size of each memory component.
; Avoid passing EBX, ECX, and ESI as arguments.
;-----
    push  ebx
    push  ecx
    push  esi
    mov   esi,address
    mov   ecx,itemCount
    mov   ebx,componentSize
    call  DumpMem
```



```

        pop     esi
        pop     ecx
        pop     ebx
    ENDM

```

### ***mDump***

The `mDump` macro displays the address and contents of a variable in hexadecimal. Pass it the name of a variable and (optionally) a character indicating that a label should be displayed next to the variable. The display format automatically matches the variable's size attribute (BYTE, WORD, or DWORD). The following example shows two calls to `mDump`:

```

.data
diskSize DWORD 12345h
.code
mDump  diskSize           ; no label
mDump  diskSize,Y        ; show label

```

The following output is produced when the code executes:

```

Dump of offset 00405000
-----
00012345
Variable name: diskSize
Dump of offset 00405000
-----
00012345

```

**Implementation** Here is a listing of the `mDump` macro, which in turn calls `mDumpMem`. It uses a new directive named `IFNB` (*if not blank*) to find out if the caller has passed an argument into the second parameter (see Section 10.3):

```

;-----
mDump MACRO varName:REQ, useLabel
;
; Displays a variable, using its known attributes.
; Receives: varName, the name of a variable.
;   If useLabel is nonblank, the name of the
;   variable is displayed.
;-----
    call Crlf
    IFNB <useLabel>
        mWrite "Variable name: &varName"
    ENDIF
    mDumpMem OFFSET varName, LENGTHOF varName, TYPE varName
ENDM

```

The `&` in `&varName` is a *substitution operator*, which permits the `varName` parameter's value to be inserted into the string literal. See Section 10.3.7 for more details.

### ***mGotoxy***

The `mGotoxy` macro locates the cursor at a specific column and row location in the console window's buffer. You can pass it 8-bit immediate values, memory operands, and register values:

```

mGotoxy 10,20 ; immediate values
mGotoxy row,col ; memory operands
mGotoxy ch,cl ; register values

```

*Implementation* Here is a source listing of the macro:

```

;-----
mGotoxy MACRO X:REQ, Y:REQ
;
; Sets the cursor position in the console window.
; Receives: X and Y coordinates (type BYTE). Avoid
; passing DH and DL as arguments.
;-----
    push  edx
    mov   dh,Y
    mov   dl,X
    call  Gotoxy
    pop   edx
ENDM

```

*Avoiding Register Conflicts* When macro arguments are registers, they can sometimes conflict with registers used internally by macros. If we call **mGotoxy** using DH and DL, for example, it does not generate correct code. To see why, let's inspect the expanded code after such parameters have been substituted:

```

1  push  edx
2  mov   dh,dl ;; row
3  mov   dl,dh ;; column
4  call  Gotoxy
5  pop   edx

```

Assuming that DL is passed as the Y value and DH is the X value, line 2 replaces DH before we have a chance to copy the column value to DL on line 3.

*Tip:* Whenever possible, macro definitions should contain comments that specify which registers cannot be used as arguments.

### **mReadString**

The **mReadString** macro inputs a string from the keyboard and stores the string in a buffer. Internally, it encapsulates a call to the **ReadString** library procedure. Pass it the name of the buffer:

```

.data
firstName BYTE 30 DUP(?)
.code
mReadString firstName

```

Here is the macro's source code:

```

;-----
mReadString MACRO varName:REQ
;
; Reads from standard input into a buffer.
; Receives: the name of the buffer. Avoid passing

```

```

;   ECX and EDX as arguments.
;-----
    push  ecx
    push  edx
    mov   edx,OFFSET varName
    mov   ecx,SIZEOF varName
    call  ReadString
    pop   edx
    pop   ecx
ENDM

```

### **mShow**

The `mShow` macro displays any register or variable's name and contents in a caller-selected format. Pass it the name of the register, followed by an optional sequence of letters identifying the desired format. Use the following codes: H = hexadecimal, D = unsigned decimal, I = signed decimal, B = binary, and N = append a newline. Multiple output formats can be combined, and multiple newlines can be specified. The default format is "HIN." `mShow` is a useful debugging aid, and is used extensively by the `DumpRegs` library procedure. You can use `mShow` as a debugging tool, to display the values of important registers or variables.

*Example* The following statements display the AX register in hexadecimal, signed decimal, unsigned decimal, and binary:

```

mov   ax,4096
mShow AX                ; default options: HIN
mShow AX,DBN           ; unsigned decimal, binary, newline

```

Here is the output:

|                                                                |
|----------------------------------------------------------------|
| <pre> AX = 1000h +4096d AX = 4096d 0001 0000 0000 0000b </pre> |
|----------------------------------------------------------------|

*Example* The following statements display AX, BX, CX, and DX in unsigned decimal, on the same output line:

```

; Insert some test values and show four registers:
mov   ax,1
mov   bx,2
mov   cx,3
mov   dx,4
mShow AX,D
mShow BX,D
mShow CX,D
mShow DX,DN

```

Here is the corresponding output:

```

AX = 1d   BX = 2d   CX = 3d   DX = 4d

```

*Example* The following call to `mShow` displays the contents of **mydword** in unsigned decimal, followed by a newline:

```

.data
mydword DWORD ?
.code
mShow mydword,DN

```

*Implementation* The implementation of `mShow` is too long to include here, but may be found in the `Macros.inc` file from the book's installation folder (C:\Irvine). When writing `mShow`, we were careful to show the current register values before they were modified by statements inside the macro itself.

### ***mShowRegister***

The `mShowRegister` macro displays the name and contents of a single 32-bit register in hexadecimal. Pass it the register's name as you want it displayed, followed by the register itself. The following macro invocation specifies the displayed name as `EBX`:

```
mShowRegister EBX, ebx
```

The following output is produced:

```
EBX=7FFD9000
```

The following invocation uses angle brackets around the label because it contains an embedded space:

```
mShowRegister <Stack Pointer>, esp
```

The following output is produced:

```
Stack Pointer=0012FFC0
```

*Implementation* Here is the macro's source code:

```

;-----
mShowRegister MACRO regName, regValue
LOCAL tempStr
;
; Displays a register's name and contents.
; Receives: the register name, the register value.
;-----
.data
tempStr BYTE " &regName=",0
.code
    push eax
; Display the register name
    push edx
    mov  edx,OFFSET tempStr
    call WriteString
    pop  edx
; Display the register contents
    mov  eax,regValue
    call WriteHex
    pop  eax
ENDM

```

**mWriteSpace**

The `mWriteSpace` macro writes one or more spaces to the console window. You can optionally pass it an integer parameter specifying the number of spaces to write (the default is one). The following statement, for example, writes five spaces:

```
mWriteSpace 5
```

*Implementation* Here is the source code for `mWriteSpace`:

```

;-----
mWriteSpace MACRO count:=<1>
;
; Writes one or more spaces to the console window.
; Receives: an integer specifying the number of spaces.
; Default value of count is 1.
;-----
LOCAL spaces
.data
spaces BYTE count DUP(' '),0
.code
    push  edx
    mov   edx,OFFSET spaces
    call WriteString
    pop   edx
ENDM

```

Section 10.3.2 explains how to use default initializers for macro parameters.

**mWriteString**

The `mWriteString` macro writes the contents of a string variable to the console window. Internally, it simplifies calls to `WriteString` by letting you pass the name of a string variable on the same statement line. For example:

```

.data
str1 BYTE "Please enter your name: ",0
.code
mWriteString str1

```

*Implementation* The following `mWriteString` implementation saves EDX on the stack, fills EDX with the string's offset, and pops EDX from the stack after the procedure call:

```

;-----
mWriteString MACRO buffer:REQ
;
; Writes a string variable to standard output.
; Receives: string variable name.
;-----
    push  edx
    mov   edx,OFFSET buffer

```

```

        call  WriteString
        pop   edx
    ENDM

```

### 10.2.6 Example Program: Wrappers

Let's create a short program named *Wraps.asm* that shows off the macros we've already introduced as procedure wrappers. Because each macro hides a lot of tedious parameter passing, the program is surprisingly compact. We will assume that all of the macros shown so far are located inside the *Macros.inc* file:

```

; Procedure Wrapper Macros          (Wraps.asm)
; This program demonstrates macros as wrappers
; for library procedures. Contents: mGotoxy, mWrite,
; mWriteString, mReadString, and mDumpMem.

INCLUDE Irvine32.inc
INCLUDE Macros.inc          ; macro definitions

.data
array DWORD 1,2,3,4,5,6,7,8
firstName BYTE 31 DUP(?)
lastName  BYTE 31 DUP(?)

.code
main PROC
    mGotoxy 0,0
    mWrite <"Sample Macro Program",0dh,0ah>

; Input the user's name.
    mGotoxy 0,5
    mWrite "Please enter your first name: "
    mReadString firstName
    call Crlf

    mWrite "Please enter your last name: "
    mReadString lastName
    call Crlf

; Display the user's name.
    mWrite "Your name is "
    mWriteString firstName
    mWriteSpace
    mWriteString lastName
    call Crlf

; Display the array of integers.
    mDumpMem OFFSET array, LENGTHOF array, TYPE array
    exit
main ENDP
END main

```

*Program Output* The following is a sample of the program's output:

```
Sample Macro Program
Please enter your first name: Joe
Please enter your last name: Smith
Your name is Joe Smith
Dump of offset 00404000
-----
00000001  00000002  00000003  00000004  00000005
00000006  00000007  00000008
```

### 10.2.7 Section Review

1. (*True/False*): When a macro is invoked, the CALL and RET instructions are automatically inserted into the assembled program.
2. (*True/False*): Macro expansion is handled by the assembler's preprocessor.
3. What is the primary advantage to using macros with parameters versus macros without them?
4. (*True/False*): As long as it is in the code segment, a macro definition may appear either before or after statements that invoke the macro.
5. (*True/False*): Replacing a long procedure with a macro containing the procedure's code will typically increase the compiled code size of a program if the macro is invoked multiple times.
6. (*True/False*): A macro cannot contain data definitions.

## 10.3 Conditional-Assembly Directives

A number of different conditional-assembly directives can be used in conjunction with macros to make them more flexible. The general syntax for conditional-assembly directives is

```
IF condition
    statements
[ELSE
    statements]
ENDIF
```

**Tip:** The constant directives shown in this chapter should not be confused with runtime directives such as .IF and .ENDIF introduced in Section 6.7. The latter evaluated expressions based on runtime values stored in registers and variables.

Table 10-3 lists the more common conditional-assembly directives. When the descriptions say that a directive *permits assembly*, it means that any subsequent statements are assembled up to the next ELSE or ENDIF directive. It must be emphasized that the directives listed in the table are evaluated at assembly time, not at runtime.

Table 10-3 Conditional-Assembly Directives.

| Directive                              | Description                                                                                                                                                   |
|----------------------------------------|---------------------------------------------------------------------------------------------------------------------------------------------------------------|
| IF <i>expression</i>                   | Permits assembly if the value of <i>expression</i> is true (nonzero). Possible relational operators are LT, GT, EQ, NE, LE, and GE.                           |
| IFB < <i>argument</i> >                | Permits assembly if <i>argument</i> is blank. The argument name must be enclosed in angle brackets (<>).                                                      |
| IFNB < <i>argument</i> >               | Permits assembly if <i>argument</i> is not blank. The argument name must be enclosed in angle brackets (<>).                                                  |
| IFIDN < <i>arg1</i> >,< <i>arg2</i> >  | Permits assembly if the two arguments are equal (identical). Uses a case-sensitive comparison.                                                                |
| IFIDNI < <i>arg1</i> >,< <i>arg2</i> > | Permits assembly if the two arguments are equal. Uses a case-insensitive comparison.                                                                          |
| IFDIF < <i>arg1</i> >,< <i>arg2</i> >  | Permits assembly if the two arguments are unequal. Uses a case-sensitive comparison.                                                                          |
| IFDIFI < <i>arg1</i> >,< <i>arg2</i> > | Permits assembly if the two arguments are unequal. Uses a case-insensitive comparison.                                                                        |
| IFDEF <i>name</i>                      | Permits assembly if <i>name</i> has been defined.                                                                                                             |
| IFNDEF <i>name</i>                     | Permits assembly if <i>name</i> has not been defined.                                                                                                         |
| ENDIF                                  | Ends a block that was begun using one of the conditional-assembly directives.                                                                                 |
| ELSE                                   | Terminates assembly of the previous statements if the condition is true. If the condition is false, ELSE assembles statements up to the next ENDIF.           |
| ELSEIF <i>expression</i>               | Assembles all statements up to ENDIF if the condition specified by a previous conditional directive is false and the value of the current expression is true. |
| EXITM                                  | Exits a macro immediately, preventing any following macro statements from being expanded.                                                                     |

### 10.3.1 Checking for Missing Arguments

A macro can check to see whether any of its arguments are blank. Often, if a blank argument is received by a macro, invalid instructions result when the macro is expanded by the preprocessor. For example, if we invoke the **mWriteString** macro without passing an argument, the macro expands with an invalid instruction when moving the string offset to EDX. The following are statements generated by the assembler, which detects the missing operand and issues an error message:

```

mWriteString
1   push edx
1   mov  edx,OFFSET
Macro2.asm(18) : error A2081: missing operand after unary operator
1   call WriteString
1   pop  edx

```

To prevent errors caused by missing operands, you can use the IFB (*if blank*) directive, which returns true if a macro argument is blank. Or, you can use the IFNB (*if not blank*) operator, which



returns true if a macro argument is not blank. Let's create an alternate version of `mWriteString` that displays an error message during assembly:

```
mWriteString MACRO string
    IFB <string>
        ECHO -----
        ECHO *   Error: parameter missing in mWriteString
        ECHO *   (no code generated)
        ECHO -----
        EXITM
    ENDIF
    push  edx
    mov   edx,OFFSET string
    call WriteString
    pop   edx
ENDM
```

(Recall from Section 10.2.2 that the `ECHO` directive writes a message to the console while a program is being assembled.) The `EXITM` directive tells the preprocessor to exit the macro and to not expand any more statements from the macro. The following shows the screen output when assembling a program with a missing parameter:

```
Assembling: Macro2.asm
```

```
-----
*   Error: parameter missing in mWriteString
*   (no code generated)
-----
```

### 10.3.2 Default Argument Initializers

Macros can have default argument initializers. If a macro argument is missing when the macro is called, the default argument is used instead. The syntax is

```
paramname := < argument >
```

(Spaces before and after the operators are optional.) For example, the `mWriteln` macro can supply a string containing a single space as its default argument. If it is called with no arguments, it still prints a space followed by an end of line:

```
mWriteln MACRO text:=<" ">
    mWrite text
    call Crlf
ENDM
```

The assembler issues an error if a null string (" ") is used as the default argument, so you have to insert at least one space between the quotes.

### 10.3.3 Boolean Expressions

The assembler permits the following relational operators to be used in constant boolean expressions containing IF and other conditional directives:

|    |                          |
|----|--------------------------|
| LT | Less than                |
| GT | Greater than             |
| EQ | Equal to                 |
| NE | Not equal to             |
| LE | Less than or equal to    |
| GE | Greater than or equal to |

### 10.3.4 IF, ELSE, and ENDIF Directives

The IF directive must be followed by a constant boolean expression. The expression can contain integer constants, symbolic constants, or constant macro arguments, but it cannot contain register or variable names. One syntax format uses just IF and ENDIF:

```
IF expression
    statement-list
ENDIF
```

Another format uses IF, ELSE, and ENDIF:

```
IF expression
    statement-list
ELSE
    statement-list
ENDIF
```

*Example: mGotoxyConst Macro* The **mGotoxyConst** macro uses the LT and GT operators to perform range checking on the arguments passed to the macro. The arguments X and Y must be constants. Another constant symbol named ERRS counts the number of errors found. Depending on the value of X, we may set ERRS to 1. Depending on the value of Y, we may add 1 to ERRS. Finally, if ERRS is greater than zero, the EXITM directive exits the macro:

```

;-----
mGotoxyConst MACRO X:REQ, Y:REQ
;
; Sets the cursor position at column X, row Y.
; Requires X and Y coordinates to be constant expressions
; in the ranges 0 <= X < 80 and 0 <= Y < 25.
;-----
    LOCAL ERRS                ;; local constant
    ERRS = 0
    IF (X LT 0) OR (X GT 79)
        ECHO Warning: First argument to mGotoxy (X) is out of range.
        ECHO *****
        ERRS = 1
    ENDIF

```

```

IF (Y LT 0) OR (Y GT 24)
    ECHO Warning: Second argument to mGotoxy (Y) is out of range.
    ECHO *****
    ERRS = ERRS + 1
ENDIF
IF ERRS GT 0                ;; if errors found,
    EXITM                   ;; exit the macro
ENDIF
push  edx
mov   dh,Y
mov   dl,X
call  Gotoxy
pop   edx
ENDM

```

### 10.3.5 The IFIDN and IFIDNI Directives

The IFIDNI directive performs a case-insensitive match between two symbols (including macro parameter names) and returns true if they are equal. The IFIDN directive performs a case-sensitive match. The former is useful when you want to make sure the caller of your macro has not used a register argument that might conflict with register usage inside the macro. The syntax for IFIDNI is

```

IFIDNI <symbol>, <symbol>
    statements
ENDIF

```

The syntax for IFIDN is identical. In the following **mReadBuf** macro, for example, the second argument cannot be EDX because it will be overwritten when the offset of **buffer** is moved into EDX. The following revised version of the macro displays a warning message if this requirement is not met:

```

;-----
mReadBuf MACRO bufferPtr, maxChars
;
; Reads from the keyboard into a buffer.
; Receives: offset of the buffer, count of the maximum
;   number of characters that can be entered. The
;   second argument cannot be edx or EDX.
;-----
IFIDNI <maxChars>,<EDX>
    ECHO Warning: Second argument to mReadBuf cannot be EDX
    ECHO *****
    EXITM
ENDIF
push  ecx
push  edx
mov   edx,bufferPtr
mov   ecx,maxChars
call  ReadString

```

```

        pop    edx
        pop    ecx
    ENDM

```

The following statement causes the macro to generate a warning message because EDX is the second argument:

```
mReadBuf OFFSET buffer,edx
```

### 10.3.6 Example: Summing a Matrix Row

Section 9.4.2 showed how to calculate the sum of a single row in a byte matrix. A programming exercise in Chapter 9 asked you to generalize the procedure for word and doubleword matrices. Although the solution to that exercise is somewhat lengthy, let us see if we can use a macro to simplify the task. First, here is the original `calc_row_sum` procedure shown in Chapter 9:

```

;-----
calc_row_sum PROC USES ebx ecx esi
;
; Calculates the sum of a row in a byte matrix.
; Receives: EBX = table offset, EAX = row index,
;           ECX = row size, in bytes.
; Returns:  EAX holds the sum.
;-----
        mul    ecx                ; row index * row size
        add    ebx,eax            ; row offset
        mov    eax,0              ; accumulator
        mov    esi,0             ; column index
L1:    movzx  edx,BYTE PTR[ebx + esi] ; get a byte
        add    eax,edx            ; add to accumulator
        inc    esi                ; next byte in row
        loop  L1
        ret
calc_row_sum ENDP

```

We start by changing PROC to MACRO, remove the RET instruction, and change ENDP to ENDM. There is no macro equivalent to the USES directive, so we insert PUSH and POP instructions:

```

mCalc_row_sum MACRO
    push ebx                ; save changed regs
    push ecx
    push esi
    mul    ecx                ; row index * row size
    add    ebx,eax            ; row offset
    mov    eax,0              ; accumulator
    mov    esi,0             ; column index
L1:    movzx  edx,BYTE PTR[ebx + esi] ; get a byte
        add    eax,edx            ; add to accumulator
        inc    esi                ; next byte in row
        loop  L1
    pop    esi                ; restore changed regs

```

```

        pop    ecx
        pop    ebx
    ENDM

```

Next, we substitute macro parameters for register parameters and initialize the registers inside the macro:

```

mCalc_row_sum MACRO index, arrayOffset, rowSize
    push    ebx                ; save changed regs
    push    ecx
    push    esi

    ; set up the required registers
    mov     eax,index
    mov     ebx,arrayOffset
    mov     ecx,rowSize

    mul     ecx                ; row index * row size
    add     ebx,eax            ; row offset
    mov     eax,0              ; accumulator
    mov     esi,0              ; column index

L1: movzx  edx,BYTE PTR[ebx + esi] ; get a byte
    add     eax,edx            ; add to accumulator
    inc     esi                ; next byte in row
    loop   L1
    pop     esi                ; restore changed regs
    pop     ecx
    pop     ebx
ENDM

```

Next, we add a parameter named **eltType** that specifies the array type (BYTE, WORD, or DWORD):

```

mCalc_row_sum MACRO index, arrayOffset, rowSize, eltType

```

The rowSize parameter, copied into ECX, currently indicates the number of bytes in each row. If we are to use it as a loop counter, it must contain the number of *elements* in each row. Therefore, we divide ECX by 2 for 16-bit arrays and by 4 for doubleword arrays. A fast way to accomplish this is to divide **eltType** by 2 and use it as a shift counter, shifting ECX to the right:

```

    shr    ecx,(TYPE eltType / 2) ; byte=0, word=1, dword=2

```

TYPE eltType becomes the scale factor in the base-index operand of the MOVZX instruction:

```

    movzx  edx,eltType PTR[ebx + esi*(TYPE eltType)]

```

MOVZX will not assemble if the right-hand operand is a doubleword, so we must use the IFIDNI operator to create a separate MOV instruction when eltType equals DWORD:

```

    IFIDNI <eltType>,<DWORD>
        mov  edx,eltType PTR[ebx + esi*(TYPE eltType)]
    ELSE
        movzx  edx,eltType PTR[ebx + esi*(TYPE eltType)]
    ENDIF

```

At last, we have the finished macro, remembering to designate label L1 as LOCAL:

```

;-----
mCalc_row_sum MACRO index, arrayOffset, rowSize, eltType
; Calculates the sum of a row in a two-dimensional array.
;
; Receives: row index, offset of the array, number of bytes
; in each table row, and the array type (BYTE, WORD, or DWORD).
; Returns:  EAX = sum.
;-----
LOCAL L1
    push  ebx                ; save changed regs
    push  ecx
    push  esi

; set up the required registers
    mov   eax,index
    mov   ebx,arrayOffset
    mov   ecx,rowSize

; calculate the row offset.
    mul   ecx                ; row index * row size
    add   ebx,eax           ; row offset

; prepare the loop counter.
    shr   ecx,(TYPE eltType / 2) ; byte=0, word=1, dword=2

; initialize the accumulator and column indexes
    mov   eax,0              ; accumulator
    mov   esi,0              ; column index

L1:
    IFIDNI <eltType>, <DWORD>
        mov  edx,eltType PTR[ebx + esi*(TYPE eltType)]
    ELSE
        movzx edx,eltType PTR[ebx + esi*(TYPE eltType)]
    ENDIF
    add   eax,edx            ; add to accumulator
    inc  esi
    loop L1

    pop   esi                ; restore changed regs
    pop   ecx
    pop   ebx
ENDM

```

Following are sample calls to the macro, using arrays of byte, word, and doubleword. See the *rowsum.asm* program:

```

.data
tableB  BYTE  10h, 20h, 30h, 40h, 50h
RowSizeB = ($ - tableB)
        BYTE  60h, 70h, 80h, 90h, 0A0h
        BYTE  0B0h, 0C0h, 0D0h, 0E0h, 0F0h

```

```

tableW    WORD    10h, 20h, 30h, 40h, 50h
RowSizeW = ($ - tableW)
           WORD    60h, 70h, 80h, 90h, 0A0h
           WORD    0B0h, 0C0h, 0D0h, 0E0h, 0F0h

tableD    DWORD   10h, 20h, 30h, 40h, 50h
RowSizeD = ($ - tableD)
           DWORD   60h, 70h, 80h, 90h, 0A0h
           DWORD   0B0h, 0C0h, 0D0h, 0E0h, 0F0h

index    DWORD ?
.code
mCalc_row_sum index, OFFSET tableB, RowSizeB, BYTE
mCalc_row_sum index, OFFSET tableW, RowSizeW, WORD
mCalc_row_sum index, OFFSET tableD, RowSizeD, DWORD

```

### 10.3.7 Special Operators

There are four assembler operators that make macros more flexible:

|    |                            |
|----|----------------------------|
| &  | Substitution operator      |
| <> | Literal-text operator      |
| !  | Literal-character operator |
| %  | Expansion operator         |

#### **Substitution Operator (&)**

The *substitution* (&) operator resolves ambiguous references to parameter names within a macro. The **mShowRegister** macro (Section 10.2.5) displays the name and hexadecimal contents of a 32-bit register. The following is a sample call:

```
.code
mShowRegister ECX
```

Following is a sample of the output generated by the call to **mShowRegister**:

```
ECX=00000101
```

A string variable containing the register name could be defined inside the macro:

```
mShowRegister MACRO regName
.data
tempStr BYTE " regName=",0
```

But the preprocessor would assume **regName** was part of a string literal and would not replace it with the argument value passed to the macro. Instead, if we add the & operator, it forces the preprocessor to insert the macro argument (such as **ECX**) into the string literal. The following shows how to define **tempStr**:

```
mShowRegister MACRO regName
.data
tempStr BYTE " &regName=",0
```

### Expansion Operator (%)

The *expansion* operator (%) expands text macros or converts constant expressions into their text representations. It does this in several different ways. When used with `TEXTEQU`, the % operator evaluates a constant expression and converts the result to an integer. In the following example, the % operator evaluates the expression (5 + count) and returns the integer 15 (as text):

```
count = 10
sumVal TEXTEQU %(5 + count)    ; = "15"
```

If a macro requires a constant integer argument, the % operator gives you the flexibility of passing an integer expression. The expression is evaluated to its integer value, which is then passed to the macro. For example, when invoking `mGotoxyConst`, the expressions here evaluate to 50 and 7:

```
mGotoxyConst %(5 * 10), %(3 + 4)
```

The preprocessor produces the following statements:

```
1  push  edx
1  mov   dh,7
1  mov   dl,50
1  call  Gotoxy
1  pop   edx
```

**% at Beginning of Line** When the expansion operator (%) is the first character on a source code line, it instructs the preprocessor to expand all text macros and macro functions found on the same line. Suppose, for example, we wanted to display the size of an array on the screen during assembly. The following attempts would not produce the intended result:

```
.data
array DWORD 1,2,3,4,5,6,7,8
.code
ECHO The array contains (SIZEOF array) bytes
ECHO The array contains %(SIZEOF array) bytes
```

The screen output would be useless:

```
The array contains (SIZEOF array) bytes
The array contains %(SIZEOF array) bytes
```

Instead, if we use `TEXTEQU` to create a text macro containing (SIZEOF array), the macro can be expanded on the next line:

```
TempStr TEXTEQU %(SIZEOF array)
%      ECHO The array contains TempStr bytes
```

The following output is produced:

```
The array contains 32 bytes
```



*Displaying the Line Number* The following **Mul32** macro multiplies its first two arguments together and returns the product in the third argument. Its parameters can be registers, memory operands, and immediate operands (except for the product):

```

Mul32 MACRO op1, op2, product
    IFIDNI <op2>, <EAX>
        LINENUM TEXTEQU %(@LINE)
        ECHO -----
%      ECHO *   Error on line LINENUM: EAX cannot be the second
        ECHO *   argument when invoking the MUL32 macro.
        ECHO -----
    EXITM
    ENDF
    push eax
    mov  eax, op1
    mul  op2
    mov  product, eax
    pop  eax
ENDM

```

**Mul32** checks one important requirement: EAX cannot be the second argument. What is interesting about the macro is that it displays the line number from where the macro was called, to make it easier to track down and fix the problem. The Text macro **LINENUM** is defined first. It references **@LINE**, a predefined assembler operator that returns the current source code line number:

```
LINENUM TEXTEQU %(@LINE)
```

Next, the expansion operator (**%**) in the first column of the line containing the **ECHO** statement causes **LINENUM** to be expanded:

```
%      ECHO *   Error on line LINENUM: EAX cannot be the second
```

Suppose the following macro call occurs in a program on line 40:

```
MUL32 val1, eax, val3
```

Then the following message is displayed during assembly:

```

-----
*   Error on line 40: EAX cannot be the second
*   argument when invoking the MUL32 macro.
-----

```

You can view a test of the **Mul32** macro in the program named *Macro3.asm*.

### **Literal-Text Operator (<>)**

The *literal-text* operator (<>) groups one or more characters and symbols into a single text literal. It prevents the preprocessor from interpreting members of the list as separate arguments. This operator is particularly useful when a string contains special characters, such as commas, percent signs (**%**), ampersands (**&**), and semicolons (**;**), that would otherwise be interpreted as delimiters or other operators. For example, the **mWrite** macro presented earlier in this chapter

receives a string literal as its only argument. If we were to pass it the following string, the preprocessor would interpret it as three separate macro arguments:

```
mWrite "Line three", 0dh, 0ah
```

Text after the first comma would be discarded because the macro expects only one argument. On the other hand, if we surrounded the string with the literal-text operator, the preprocessor considers all text between the brackets to be a single macro argument:

```
mWrite <"Line three", 0dh, 0ah>
```

### **Literal-Character Operator (!)**

The *literal-character* operator (!) was invented for much the same purpose as the literal-text operator: It forces the preprocessor to treat a predefined operator as an ordinary character. In the following TEXTEQU definition, the ! operator prevents the > symbol from being a text delimiter:

```
BadYValue TEXTEQU <Warning: Y-coordinate is !> 24>
```

*Warning Message Example* The following example helps to show how the %, &, and ! operators work together. Let's assume we have defined the **BadYValue** symbol. We can create a macro named **ShowWarning** that receives a text argument, encloses it in quotes, and passes the literal to the **mWrite** macro. Note the use of the substitution (&) operator:

```
ShowWarning MACRO message
    mWrite "&message"
ENDM
```

Next, we invoke **ShowWarning**, passing it the expression %BadYValue. The % operator evaluates (dereferences) **BadYValue** and produces its equivalent string:

```
.code
ShowWarning %BadYValue
```

As you might expect, the program runs and displays the warning message:

```
Warning: Y-coordinate is > 24
```

### **10.3.8 Macro Functions**

A macro function is similar to a macro procedure in that it assigns a name to a list of assembly language statements. It is different in that it always returns a constant (integer or string) via the EXITM directive. In the following example, the **IsDefined** macro returns true (-1) if a given symbol has been defined; otherwise, it returns false (0):

```
IsDefined MACRO symbol
    IFDEF symbol
        EXITM <-1>                ;; True
    ELSE
        EXITM <0>                 ;; False
    ENDIF
ENDM
```

The EXITM (exit macro) directive halts all further expansion of the macro.

*Invoking a Macro Function* When you invoke a macro function, its argument list must be enclosed in parentheses. For example, we can call the **IsDefined** macro, passing it **RealMode**, the name of a symbol which may or may not have been defined:

```
IF IsDefined( RealMode )
    mov    ax,@data
    mov    ds,ax
ENDIF
```

If the assembler has already encountered a definition of **RealMode** before this point in the assembly process, it assembles the two instructions:

```
mov ax,@data
mov ds,ax
```

The same IF directive can be placed inside a macro named **Startup**:

```
Startup MACRO
    IF IsDefined( RealMode )
        mov    ax,@data
        mov    ds,ax
    ENDIF
ENDM
```

A macro such as **IsDefined** can be useful when you design programs for multiple memory models. For example, we can use it to determine which include file to use:

```
IF IsDefined( RealMode )
    INCLUDE Irvine16.inc
ELSE
    INCLUDE Irvine32.inc
ENDIF
```

*Defining the RealMode Symbol* All that remains is to find a way to define the **RealMode** symbol. One way is to put the following line at the beginning of a program:

```
RealMode = 1
```

Alternatively, the assembler's command line has an option for defining symbols, using the **-D** switch. The following ML command defines the **RealMode** symbol and assigns it a value of 1:

```
ML -c -DRealMode=1 myProg.asm
```

The corresponding ML command for protected mode programs does not define the **RealMode** symbol:

```
ML -c myProg.asm
```

*HelloNew Program* The following program (*HelloNew.asm*) uses the macros we have just described, displaying a message on the screen:

```
; Macro Functions                (HelloNew.asm)
INCLUDE Macros.inc
IF IsDefined( RealMode )
    INCLUDE Irvine16.inc
```

```
ELSE
    INCLUDE Irvine32.inc
ENDIF

.code
main PROC
    Startup
    mWrite <"This program can be assembled to run ",0dh,0ah>
    mWrite <"in both Real mode and Protected mode.",0dh,0ah>
    exit
main ENDP
END main
```

Real-mode programming is covered in Chapters 14–17. A 16-bit Real Mode program runs in a simulated MS-DOS environment, and uses the `Irvine16.inc` include file and the `Irvine16` link library.

### 10.3.9 Section Review

1. What is the purpose of the `IFB` directive?
2. What is the purpose of the `IFIDN` directive?
3. Which directive stops all further expansion of a macro?
4. How is `IFIDNI` different from `IFIDN`?
5. What is the purpose of the `IFDEF` directive?

## 10.4 Defining Repeat Blocks

MASM has a number of looping directives for generating repeated blocks of statements: `WHILE`, `REPEAT`, `FOR`, and `FORC`. Unlike the `LOOP` instruction, these directives work only at assembly time, using constant values as loop conditions and counters:

- The `WHILE` directive repeats a statement block based on a boolean expression.
- The `REPEAT` directive repeats a statement block based on the value of a counter.
- The `FOR` directive repeats a statement block by iterating over a list of symbols.
- The `FORC` directive repeats a statement block by iterating over a string of characters.

Each is demonstrated in an example program named *Repeat.asm*.

### 10.4.1 WHILE Directive

The `WHILE` directive repeats a statement block as long as a particular constant expression is true. The syntax is

```
WHILE constExpression
    statements
ENDM
```

The following code shows how to generate Fibonacci numbers between 1 and `F0000000h` as a series of assembly-time constants:

```
.data
v11 = 1
```

```

    val2 = 1
    DWORD val1                ; first two values
    DWORD val2
    val3 = val1 + val2
    WHILE val3 LT 0F0000000h
        DWORD val3
        val1 = val2
        val2 = val3
        val3 = val1 + val2
    ENDM

```

The values generated by this code can be viewed in a listing (.LST) file.

### 10.4.2 REPEAT Directive

The REPEAT directive repeats a statement block a fixed number of times at assembly time. The syntax is

```

REPEAT constExpression
    statements
ENDM

```

*constExpression*, an unsigned constant integer expression, determines the number of repetitions.

REPEAT can be used in a similar way as DUP to create an array. In the following example, the WeatherReadings struct contains a location string, followed by an array of rainfall and humidity readings:

```

WEEKS_PER_YEAR = 52
WeatherReadings STRUCT
    location BYTE 50 DUP(0)
    REPEAT WEEKS_PER_YEAR
        LOCAL rainfall, humidity
        rainfall DWORD ?
        humidity DWORD ?
    ENDM
WeatherReadings ENDS

```

The LOCAL directive was used to avoid errors caused by redefining rainfall and humidity when the loop was repeated at assembly time.

### 10.4.3 FOR Directive

The FOR directive repeats a statement block by iterating over a comma-delimited list of symbols. Each symbol in the list causes one iteration of the loop. The syntax is

```

FOR parameter, <arg1, arg2, arg3, ...>
    statements
ENDM

```

On the first loop iteration, *parameter* takes on the value of *arg1*; on the second iteration, *parameter* takes on the value of *arg2*; and so on through the last argument in the list.

**Student Enrollment Example** Let's create a student enrollment scenario in which we have a COURSE structure containing a course number and number of credits. A SEMESTER structure contains an array of six courses and a counter named **NumCourses**:

```

COURSE STRUCT
    Number  BYTE 9 DUP(?)
    Credits BYTE ?
COURSE ENDS

; A semester contains an array of courses.
SEMESTER STRUCT
    Courses COURSE 6 DUP(<>)
    NumCourses WORD ?
SEMESTER ENDS

```

We can use a FOR loop to define four SEMESTER objects, each having a different name selected from the list of symbols between angle brackets:

```

.data
FOR semName, <Fall2013, Spring2014, Summer2014, Fall2014>
    semName SEMESTER <>
ENDM

```

If we inspect the listing file, we find the following variables:

```

.data
Fall2013 SEMESTER <>
Spring2014 SEMESTER <>
Summer2014 SEMESTER <>
Fall2014 SEMESTER <>

```

#### 10.4.4 FORC Directive

The FORC directive repeats a statement block by iterating over a string of characters. Each character in the string causes one iteration of the loop. The syntax is

```

FORC parameter, <string>
    statements
ENDM

```

On the first loop iteration, *parameter* is equal to the first character in the string; on the second iteration, *parameter* is equal to the second character in the string; and so on, to the end of the string. The following example creates a character lookup table consisting of several nonalphabetic characters. Note that < and > must be preceded by the literal-character (!) operator to prevent them from violating the syntax of the FORC directive:

```

Delimiters LABEL BYTE
FORC code, <@#$$%^&*!<!>>
    BYTE "&code"
ENDM

```

The following data table is generated, which you can view in the listing file:

```

00000000 40 1 BYTE "@"
00000001 23 1 BYTE "#"
00000002 24 1 BYTE "$"
00000003 25 1 BYTE "%"
00000004 5E 1 BYTE "^"
00000005 26 1 BYTE "&"

```

```

00000006  2A  1 BYTE  "*"
00000007  3C  1 BYTE  "<"
00000008  3E  1 BYTE  ">"

```

### 10.4.5 Example: Linked List

It is fairly simple to combine a structure declaration with the REPEAT directive to instruct the assembler to create a linked list data structure. Each node in a linked list contains a data area and a link area:



In the data area, one or more variables can hold data unique to each node. In the link area, a pointer contains the address of the next node in the list. The link part of the final node usually contains a null pointer. Let's create a program that creates and displays a simple linked list. First, the program defines a list node having a single integer (data) and a pointer to the next node:

```

ListNode STRUCT
    NodeData DWORD ?           ; the node's data
    NextPtr  DWORD ?           ; pointer to next node
ListNode ENDS

```

Next, the REPEAT directive creates multiple instances of **ListNode** objects. For testing purposes, the **NodeData** field contains an integer constant ranging from 1 to 15. Inside the loop, we increment the counter and insert values into the **ListNode** fields:

```

TotalNodeCount = 15
NULL = 0
Counter = 0

.data
LinkedList LABEL PTR ListNode
REPEAT TotalNodeCount
    Counter = Counter + 1
    ListNode <Counter, ($ + Counter * SIZEOF ListNode)>
ENDM

```

The expression ( $\$ + \text{Counter} * \text{SIZEOF } \text{ListNode}$ ) tells the assembler to multiply the counter by the **ListNode** size and add their product to the current location counter. The value is inserted into the **NextPtr** field in the structure. [It's interesting to note that the location counter's value ( $\$$ ) remains fixed at the first node of the list.] The list is given a *tail node* marking its end, in which the **NextPtr** field contains null (0):

```

ListNode <0,0>

```

When the program traverses the list, it uses the following statements to retrieve the **NextPtr** field and compare it to NULL so the end of the list can be detected:

```

mov  eax, (ListNode PTR [esi]).NextPtr
cmp  eax, NULL

```

*Program Listing* The following is a complete program listing. In main, a loop traverses the list and displays all the node values. Rather than using a fixed counter for the loop, the program checks for the null pointer in the tail node and stops looping when it is found:

```

; Creating a Linked List                (List.asm)

INCLUDE Irvine32.inc

ListNode STRUCT
    NodeData DWORD ?
    NextPtr  DWORD ?
ListNode ENDS

TotalNodeCount = 15
NULL = 0
Counter = 0

.data
LinkedList LABEL PTR ListNode
REPEAT TotalNodeCount
    Counter = Counter + 1
    ListNode <Counter, ($ + Counter * SIZEOF ListNode)>
ENDM
ListNode <0,0>                ; tail node

.code
main PROC
    mov  esi,OFFSET LinkedList

; Display the integers in the NodeData fields.
NextNode:
    ; Check for the tail node.
    mov  eax,(ListNode PTR [esi]).NextPtr
    cmp  eax,NULL
    je   quit

    ; Display the node data.
    mov  eax,(ListNode PTR [esi]).NodeData
    call WriteDec
    call Crlf

    ; Get pointer to next node.
    mov  esi,(ListNode PTR [esi]).NextPtr
    jmp  NextNode

quit:
    exit
main ENDP
END main

```

### 10.4.6 Section Review

1. Briefly describe the WHILE directive.
2. Briefly describe the REPEAT directive.
3. Briefly describe the FOR directive.



4. Briefly describe the FORC directive.
5. Which looping directive would be the best tool to generate a character lookup table?
6. Write the statements generated by the following macro:

```
FOR val,<100,20,30>
    BYTE 0,0,0,val
ENDM
```

7. Assume the following **mRepeat** macro has been defined:

```
mRepeat MACRO char,count
    LOCAL L1
    mov    cx,count
L1: mov    ah,2
    mov    dl,char
    int    21h
    loop  L1
ENDM
```

Write the code generated by the preprocessor when the **mRepeat** macro is expanded by each of the following statements (a, b, and c):

```
mRepeat 'X',50           ; a
mRepeat AL,20           ; b
mRepeat byteVal,countVal ; c
```

8. *Challenge:* In the Linked List example program (Section 10.4.5), what would be the result if the REPEAT loop were coded as follows?

```
REPEAT TotalNodeCount
    Counter = Counter + 1
    ListNode <Counter, ($ + SIZEOF ListNode)>
ENDM
```

## 10.5 Chapter Summary

A *structure* is a template or pattern used when creating user-defined types. Many structures are already defined in the Windows API library and are used for the transfer of data between application programs and the library. Structures can contain a diverse set of field types. Each field declaration may use a field-initializer, which assigns a default value to the field.

Structures themselves take up no memory, but structure variables do. The `sizeof` operator returns the number of bytes used by the variable.

The dot operator (`.`) references a structure field by using either a structure variable or an indirect operand such as `[esi]`. When an indirect operand references a structure field, you must use the PTR operator to identify the structure type, as in `(COORD PTR [esi]).X`.

Structures can contain fields that are also structures. An example was shown in the Drunkard's Walk program (Section 10.1.6), where the **DrunkardWalk** structure contained an array of COORD structures.

Macros are usually defined at the beginning of a program, before the data and code segments. Then, when a macro is called, the preprocessor inserts a copy of the macro's code into the program at the calling location.

Macros can be effectively used as *wrappers* around procedure calls to simplify parameter passing and saving registers on the stack. Macros such as **mGotoxy**, **mDumpMem**, and **mWriteString** are examples of wrappers because they call procedures from the book's link library.

A *macro procedure* (or *macro*) is a named block of assembly language statements. A *macro function* is similar, except that it also returns a constant value.

Conditional-assembly directives, such as IF, IFNB, and IFIDNI, can be used to detect arguments that are out of range, missing, or of the wrong type. The ECHO directive displays error messages during assembly, making it possible to alert the programmer to errors in arguments passed to macros.

The substitution operator (&) resolves ambiguous references to parameter names. The expansion operator (%) expands text macros and converts constant expressions to text. The literal-text operator (<>) groups diverse characters and text into a single literal. The literal-character operator (!) forces the preprocessor to treat predefined operators as ordinary characters.

Repeat block directives can reduce the amount of repetitive code in programs. The directives are as follows:

- WHILE repeats a statement block based on a boolean expression.
- REPEAT repeats a statement block based on the value of a counter.
- FOR repeats a statement block by iterating over a list of symbols.
- FORC repeats a statement block by iterating over a string of characters.

## 10.6 Key Terms

### 10.6.1 Terms

|                                |                           |
|--------------------------------|---------------------------|
| conditional-assembly directive | macro function            |
| default argument initializer   | macro procedure           |
| expansion operator (%)         | nested macro              |
| field                          | parameters                |
| invoke (a macro)               | preprocessing step        |
| literal-character operator (!) | structure                 |
| literal-text operator (<>)     | substitution operator (&) |
| macro                          | union                     |

### 10.6.2 Operators and Directives

|       |        |          |
|-------|--------|----------|
| ALIGN | FORC   | IFIDNI   |
| ECHO  | IF     | IFNB     |
| ELSE  | IFB    | IFNDEF   |
| ENDIF | IFDEF  | LENGTHOF |
| ENDS  | IFDIF  | LOCAL    |
| EXITM | IFDIFI | MACRO    |
| FOR   | IFIDN  | OFFSET   |

|        |        |       |
|--------|--------|-------|
| REPEAT | STRUCT | WHILE |
| REQ    | TYPE   |       |
| SIZEOF | UNION  |       |

## 10.7 Review Questions and Exercises

### 10.7.1 Short Answer

1. What is the purpose of the STRUCT directive?
2. Assume that the following structure has been defined:

```
RentalInvoice STRUCT
    invoiceNum BYTE 5 DUP(' ')
    dailyPrice WORD ?
    daysRented WORD ?
RentalInvoice ENDS
```

State whether or not each of the following declarations is valid:

- a. `rentals RentalInvoice <>`
  - b. `RentalInvoice rentals <>`
  - c. `march RentalInvoice <'12345',10,0>`
  - d. `RentalInvoice <,10,0>`
  - e. `current RentalInvoice <,15,0,0>`
3. (*True/False*): A macro cannot contain data definitions.
  4. What is the purpose of the LOCAL directive?
  5. Which directive displays a message on the console during the assembly step?
  6. Which directive marks the end of a conditional block of statements?
  7. List all the relational operators that can be used in constant boolean expressions.
  8. What is the purpose of the & operator in a macro definition?
  9. What is the purpose of the ! operator in a macro definition?
  10. What is the purpose of the % operator in a macro definition?

### 10.7.2 Algorithm Workbench

1. Create a structure named SampleStruct containing two fields: field1, a single 16-bit WORD, and field2, an array of 20 32-bit DWORDs. The initial values of the fields may be left undefined.
2. Write a statement that retrieves the **wHour** field of a SYSTEMTIME structure.
3. Using the following **Triangle** structure, declare a structure variable and initialize its vertices to (0,0), (5, 0), and (7,6):

```
Triangle STRUCT
    Vertex1 COORD <>
    Vertex2 COORD <>
    Vertex3 COORD <>
Triangle ENDS
```

4. Declare an array of **Triangle** structures. Write a loop that initializes **Vertex1** of each triangle to random coordinates in the range (0...10, 0...10).
5. Write a macro named **mPrintChar** that displays a single character on the screen. It should have two parameters: this first specifies the character to be displayed and the second specifies how many times the character should be repeated. Here is a sample call:

```
mPrintChar 'x',20
```

6. Write a macro named **mGenRandom** that generates a random integer between 0 and  $n - 1$ . Let  $n$  be the only parameter.
7. Write a macro named **mPromptInteger** that displays a prompt and inputs an integer from the user. Pass it a string literal and the name of a doubleword variable. Sample call:

```
.data
minVal DWORD ?
.code
mPromptInteger "Enter the minimum value", minVal
```

8. Write a macro named **mWriteAt** that locates the cursor and writes a string literal to the console window. Suggestion: Invoke the **mGotoxy** and **mWrite** macros from the book's macro library.
9. Show the expanded code produced by the following statement that invokes the **mWriteString** macro from Section 10.2.5:

```
mWriteStr namePrompt
```

10. Show the expanded code produced by the following statement that invokes the **mReadString** macro from Section 10.2.5:

```
mReadStr customerName
```

11. Write a macro named **mDumpMemx** that receives a single parameter, the name of a variable. Your macro must call the **mDumpMem** macro from the book's library, passing it the variable's offset, number of units, and unit size. Demonstrate a call to the **mDumpMemx** macro.
12. Show an example of a macro parameter having a default argument initializer.
13. Write a short example that uses the **IF**, **ELSE**, and **ENDIF** directives.
14. Write a statement using the **IF** directive that checks the value of the constant macro parameter **Z**; if **Z** is less than zero, display a message during assembly indicating that **Z** is invalid.
15. Write a short macro that demonstrates the use of the **&** operator when the macro parameter is embedded in a literal string.
16. Assume the following **mLocate** macro definition:

```
mLocate MACRO xval,yval
    IF xval LT 0                ;; xval < 0?
        EXITM                  ;; if so, exit
    ENDF
    IF yval LT 0                ;; yval < 0?
        EXITM                  ;; if so, exit
    ENDF
```

```

        mov bx,0                ;; video page 0
        mov ah,2                ;; locate cursor
        mov dh,yval
        mov dl,xval
        int 10h                ;; call the BIOS
    ENDM

```

Show the source code generated by the preprocessor when the macro is expanded by each of the following statements:

```

.data
row BYTE 15
col BYTE 60
.code
mLocate -2,20
mLocate 10,20
mLocate col,row

```

## 10.8 Programming Exercises

### ★ 1. mReadkey Macro

Create a macro that waits for a keystroke and returns the key that was pressed. The macro should include parameters for the ASCII code and keyboard scan code. *Hint:* Call `ReadChar` from the book's link library. Write a program that tests your macro. For example, the following code waits for a key; when it returns, the two arguments contain the ASCII code and scan code:

```

.data
ascii BYTE ?
scan BYTE ?
.code
mReadkey ascii, scan

```

### ★ 2. mWritestringAttr Macro

(Requires reading ahead to Section 11.1.11.) Create a macro that writes a null-terminated string to the console with a given text color. The macro parameters should include the string name and the color. *Hint:* Call `SetTextColor` from the book's link library. Write a program that tests your macro with several strings in different colors. Sample call:

```

.data
myString db "Here is my string",0
.code
mWritestring myString, white

```

### ★ 3. mMove32 Macro

Write a macro named `mMove32` that receives two 32-bit memory operands. The macro should move the source operand to the destination operand. Write a program that tests your macro.

★ 4. **mMult32 Macro**

Create a macro named **mMult32** that multiplies two 32-bit memory operands and produces a 32-bit product. Write a program that tests your macro.

★★ 5. **mReadInt Macro**

Create a macro named **mReadInt** that reads a 16- or 32-bit signed integer from standard input and returns the value in an argument. Use conditional operators to allow the macro to adapt to the size of the desired result. Write a program that tests the macro, passing it operands of various sizes.

★★ 6. **mWriteInt Macro**

Create a macro named **mWriteInt** that writes a signed integer to standard output by calling the **WriteInt** library procedure. The argument passed to the macro can be a byte, word, or doubleword. Use conditional operators in the macro so it adapts to the size of the argument. Write a program that tests the macro, passing it arguments of different sizes.

★★★ 7. **The Professor's Lost Phone**

When the professor took the drunkard's walk around campus in Section 10.1.6, we discovered that he lost his cell phone somewhere along the path. When you simulate the drunken walk, your program must drop the phone wherever the professor is standing at some random time interval. Each time you run the program, the cell phone will be lost at a different time interval (and location).

★★★ 8. **Drunkard's Walk with Probabilities**

When testing the **DrunkardWalk** program, you may have noticed that the professor doesn't seem to wander very far from the starting point. This is no doubt caused by an equal probability of the professor moving in any direction. Modify the program so there is a 50% probability the professor will continue to walk in the same direction as he or she did when taking the previous step. There should be a 10% probability that he or she will reverse direction and a 20% probability that he or she will turn either right or left. Assign a default starting direction before the loop begins.

★★★★ 9. **Shifting Multiple Doublewords**

Create a macro that shifts an array of 32-bit integers a variable number of bits in either direction, using the **SHRD** and **SHLD** instructions. Write a test program that tests your macro by shifting the same array in both directions and displaying the resulting values. You can assume that the array is in little-endian order. Here is a sample macro declaration:

```
mShiftDoublewords MACRO arrayName, direction, numberOfBits
```

```
Parameters:
```

```
arrayName      Name of the array
direction      Right (R) or Left (L)
numberOfBits   Number of bit positions to shift
```

★★★★ 10. **Three-Operand Instructions**

Some computer instruction sets permit arithmetic instructions with three operands. Such operations sometimes appear in simple virtual assemblers used to introduce students to the concept of

assembly language or using intermediate language in compilers. In the following macros, assume EAX is reserved for macro operations and is not preserved. Other registers modified by the macro must be preserved. All parameters are signed memory doublewords. Write macros that simulate the following operations:

- a. `add3 destination, source1, source2`
- b. `sub3 destination, source1, source2 (destination = source1 - source2)`
- c. `mul3 destination, source1, source2`
- d. `div3 destination, source1, source2 (destination = source1 / source2)`

For example, the following macro calls implement the expression  $x = (w + y) * z$ :

```
.data
temp DWORD ?
.code
add3 temp, w, y           ; temp = w + y
mul3 x, temp, z          ; x = temp * z
```

Write a program that tests your macros by implementing four arithmetic expressions, each involving multiple operations.

---

# MS-Windows PROGRAMMING

- 11.1 Win32 Console Programming
  - 11.1.1 Background Information
  - 11.1.2 Win32 Console Functions
  - 11.1.3 Displaying a Message Box
  - 11.1.4 Console Input
  - 11.1.5 Console Output
  - 11.1.6 Reading and Writing Files
  - 11.1.7 File I/O in the Irvine32 Library
  - 11.1.8 Testing the File I/O Procedures
  - 11.1.9 Console Window Manipulation
  - 11.1.10 Controlling the Cursor
  - 11.1.11 Controlling the Text Color
  - 11.1.12 Time and Date Functions
  - 11.1.13 Using the 64-Bit Windows API
  - 11.1.14 Section Review
- 11.2 Writing a Graphical Windows Application
  - 11.2.1 Necessary Structures
  - 11.2.2 The MessageBox Function
  - 11.2.3 The WinMain Procedure
  - 11.2.4 The WinProc Procedure
  - 11.2.5 The ErrorHandler Procedure
  - 11.2.6 Program Listing
  - 11.2.7 Section Review
- 11.3 Dynamic Memory Allocation
  - 11.3.1 HeapTest Programs
  - 11.3.2 Section Review
- 11.4 x86 Memory Management
  - 11.4.1 Linear Addresses
  - 11.4.2 Page Translation
  - 11.4.3 Section Review
- 11.5 Chapter Summary
- 11.6 Key Terms
- 11.7 Review Questions and Exercises
  - 11.7.1 Short Answer
  - 11.7.2 Algorithm Workbench
- 11.8 Programming Exercises

## 11.1 Win32 Console Programming

In earlier chapters, you have no doubt been curious as to how we implemented the book's link libraries (Irvine32 and Irvine64). While the libraries are convenient, we would like you to become more independent so you can either create your own library or improve ours. Therefore, this chapter shows how to use the 32-bit Microsoft Windows API for console window programming. An *Application Programming Interface* (API) is a collection of types, constants, and functions that provide a way to manipulate objects using computer code. We discuss API functions



for text I/O, color selection, dates and times, data file I/O, and memory management. We will also include a few examples of code written for the book's 64-bit library, named *Irvine64*.

You will also learn how to create a graphical windows application with an event processing loop. We're not suggesting that you use assembly language for extended graphical applications, but our examples should help to unmask some of the abstractions that high level languages use to hide internal details.

Finally, we discuss the memory management capabilities of x86 processors, including linear and logical addresses, as well as segmentation and paging. Although college-level operating systems courses cover these topics in greater breadth and detail, this chapter can give you a low-level introduction to this area.

Why not write graphical applications for MS-Windows? If written in assembly language or C, graphical programs are long and detailed. For years, C and C++ programmers have labored over technical details such as graphical device handles, message posting, font metrics, device bitmaps, and mapping modes, with the help of excellent authors. There is a devoted group of assembly language programmers with excellent Websites who do graphical Windows programming.

To provide some interest to graphical programmers, Section 11.2 introduces 32-bit graphical programming in a generic sort of way. It's only a start, but you might be inspired to go further into the topic. A list of recommended books for further study is given in the summary at the end of this chapter.

**Win32 Platform SDK** Closely related to the Win32 API is the Microsoft *Platform SDK (Software Development Kit)*, a collection of tools, libraries, sample code, and documentation for creating MS-Windows applications. Complete documentation is available online at Microsoft's Web site. Search for "Platform SDK" at [www.msdn.microsoft.com](http://www.msdn.microsoft.com). The Platform SDK is a free download.

**Tip:** The Irvine32 library is compatible with Win32 API functions, so you can call both from the same program.

### 11.1.1 Background Information

When a Windows application starts, it creates either a console window or a graphical window. We have been using the following option with the LINK command in our project files. It tells the linker to create a console-based application:

```
/SUBSYSTEM:CONSOLE
```

A console program looks and behaves like an MS-DOS window, with some enhancements, which we will see later. The console has a single input buffer and one or more screen buffers:

- The *input buffer* contains a queue of *input records*, each containing data about an input event. Examples of input events are keyboard input, mouse clicks, and the user's resizing of the console window.
- A *screen buffer* is a two-dimensional array of character and color data that affects the appearance of text in the console window.

## Win32 API Reference Information

**Functions** Throughout this section, we will introduce you to a subset of Win32 API functions and provide a few simple examples. Many details cannot be covered here because of space limitations. To find out more, visit the Microsoft MSDN Web site (currently located at [www.msdn.microsoft.com](http://www.msdn.microsoft.com)). When searching for functions or identifiers, set the *Filtered by* parameter to **Platform SDK**. Also, in the sample programs supplied with this book, the `kernel32.txt` and `user32.txt` files provide comprehensive lists of function names in the `kernel32.lib` and `user32.lib` libraries.

**Constants** Often when reading documentation for Win32 API functions, you will come across constant names, such as `TIME_ZONE_ID_UNKNOWN`. In a few cases, the constant will already be defined in `SmallWin.inc`. But if you can't find it there, look on our book's Web site. A header file named `WinNT.h`, for example, defines `TIME_ZONE_ID_UNKNOWN` along with related constants:

```
#define TIME_ZONE_ID_UNKNOWN 0
#define TIME_ZONE_ID_STANDARD 1
#define TIME_ZONE_ID_DAYLIGHT 2
```

Using this information, you would add the following to `SmallWin.h` or your own include file:

```
TIME_ZONE_ID_UNKNOWN = 0
TIME_ZONE_ID_STANDARD = 1
TIME_ZONE_ID_DAYLIGHT = 2
```

## Character Sets and Windows API Functions

Two types of character sets are used when calling functions in the Win32 API: the 8-bit ASCII/ANSI character set and the 16-bit Unicode set (available in all recent versions of Windows). Win32 functions dealing with text are usually supplied in two versions, one ending in the letter A (for 8-bit ANSI characters) and the other ending in W (for *wide* character sets, including Unicode). One of these is `WriteConsole`:

- `WriteConsoleA`
- `WriteConsoleW`

Function names ending in W are not supported by Windows 95 or 98. In all recent versions of Windows, on the other hand, Unicode is the native character set. If you call a function such as **WriteConsoleA**, for example, the operating system converts the characters from ANSI to Unicode and calls **WriteConsoleW**.

In the Microsoft MSDN Library documentation for functions such as `WriteConsole`, the trailing A or W is omitted from the name. In the include file for the programs in this book, we redefine function names such as **WriteConsoleA**:

```
WriteConsole EQU <WriteConsoleA>
```

This definition makes it possible to call `WriteConsole` using its generic name.

### High-Level and Low-Level Access

There are two levels of access to the console, permitting tradeoffs between simplicity and complete control:

- High-level console functions read a stream of characters from the console's input buffer. They write character data to the console's screen buffer. Both input and output can be redirected to read from or write to text files.
- Low-level console functions retrieve detailed information about keyboard and mouse events and user interactions with the console window (dragging, resizing, etc.). These functions also permit detailed control of the window size and position, as well as text colors.

### Windows Data Types

Win32 functions are documented using function declarations for C/C++ programmers. In these declarations, the types of all function parameters are based either on standard C types or on one of the MS-Windows predefined types (a partial list is in Table 11-1). It is important to distinguish data values from pointers to values. A type name that begins with the letters LP is a *long pointer* to some other object.

### SmallWin.inc Include File

*SmallWin.inc*, created by the author, is an include file containing constant definitions, text equates, and function prototypes for Win32 API programming. It is automatically included in programs by *Irvine32.inc*, which we have been using throughout the book. The file is located in the *Examples\Lib32* folder where you installed the sample programs from this book. Most of the constants can be found in *Windows.h*, a header file used for programming in C and C++. Despite its name, *SmallWin.inc* is rather large, so we'll just show highlights:

```
DO_NOT_SHARE = 0
NULL = 0
TRUE = 1
FALSE = 0

; Win32 Console handles
STD_INPUT_HANDLE EQU -10
STD_OUTPUT_HANDLE EQU -11
STD_ERROR_HANDLE EQU -12
```

The HANDLE type, an alias for DWORD, helps our function prototypes to be more consistent with the Microsoft Win32 documentation:

```
HANDLE TEXTEQU <DWORD>
```

Table 11-1 Translating MS-Windows Types to MASM.

| MS-Windows Type | MASM Type | Description                     |
|-----------------|-----------|---------------------------------|
| BOOL, BOOLEAN   | DWORD     | A boolean value (TRUE or FALSE) |
| BYTE            | BYTE      | An 8-bit unsigned integer       |
| CHAR            | BYTE      | An 8-bit Windows ANSI character |

Table 11-1 (Continued)

| MS-Windows Type | MASM Type | Description                                                                                                 |
|-----------------|-----------|-------------------------------------------------------------------------------------------------------------|
| COLORREF        | DWORD     | A 32-bit value used as a color value                                                                        |
| DWORD           | DWORD     | A 32-bit unsigned integer                                                                                   |
| HANDLE          | DWORD     | Handle to an object                                                                                         |
| HFILE           | DWORD     | Handle to a file opened by OpenFile                                                                         |
| INT             | SDWORD    | A 32-bit signed integer                                                                                     |
| LONG            | SDWORD    | A 32-bit signed integer                                                                                     |
| LPARAM          | DWORD     | Message parameter, used by window procedures and callback functions                                         |
| LPCSTR          | PTR BYTE  | A 32-bit pointer to a constant null-terminated string of 8-bit Windows (ANSI) characters                    |
| LPCVOID         | DWORD     | Pointer to a constant of any type                                                                           |
| LPSTR           | PTR BYTE  | A 32-bit pointer to a null-terminated string of 8-bit Windows (ANSI) characters                             |
| LPCTSTR         | PTR WORD  | A 32-bit pointer to a constant character string that is portable for Unicode and double-byte character sets |
| LPTSTR          | PTR WORD  | A 32-bit pointer to a character string that is portable for Unicode and double-byte character sets          |
| LPVOID          | DWORD     | A 32-bit pointer to an unspecified type                                                                     |
| LRESULT         | DWORD     | A 32-bit value returned from a window procedure or callback function                                        |
| SIZE_T          | DWORD     | The maximum number of bytes to which a pointer can point                                                    |
| UINT            | DWORD     | A 32-bit unsigned integer                                                                                   |
| WNDPROC         | DWORD     | A 32-bit pointer to a window procedure                                                                      |
| WORD            | WORD      | A 16-bit unsigned integer                                                                                   |
| WPARAM          | DWORD     | A 32-bit value passed as a parameter to a window procedure or callback function                             |

SmallWin.inc also includes structure definitions used in Win32 calls. Two are shown here:

```
COORD STRUCT
    X WORD ?
    Y WORD ?
COORD ENDS

SYSTEMTIME STRUCT
    wYear WORD ?
    wMonth WORD ?
    wDayOfWeek WORD ?
    wDay WORD ?
    wHour WORD ?
    wMinute WORD ?
    wSecond WORD ?
    wMilliseconds WORD ?
SYSTEMTIME ENDS
```

Finally, `SmallWin.inc` contains function prototypes for all Win32 functions documented in this chapter.

### Console Handles

Nearly all Win32 console functions require you to pass a handle as the first argument. A *handle* is a 32-bit unsigned integer that uniquely identifies an object such as a bitmap, drawing pen, or any input/output device:

```
STD_INPUT_HANDLE    standard input
STD_OUTPUT_HANDLE   standard output
STD_ERROR_HANDLE    standard error output
```

The latter two handles are used when writing to the console's active screen buffer.

The `GetStdHandle` function returns a handle to a console stream: input, output, or error output. You need a handle in order to do any input/output in a console-based program. Here is the function prototype:

```
GetStdHandle PROTO,
    nStdHandle:HANDLE    ; handle type
```

*nStdHandle* can be `STD_INPUT_HANDLE`, `STD_OUTPUT_HANDLE`, or `STD_ERROR_HANDLE`. The function returns the handle in EAX, which should be copied into a variable for safekeeping. Here is a sample call:

```
.data
inputHandle HANDLE ?
.code
    INVOKE GetStdHandle, STD_INPUT_HANDLE
    mov inputHandle,eax
```

#### 11.1.2 Win32 Console Functions

Table 11-2 contains a quick reference to the complete set of Win32 console functions.<sup>1</sup> You can find a complete description of each function in the MSDN library at [www.msdn.microsoft.com](http://www.msdn.microsoft.com).

**Tip:** Win32 API functions do not preserve EAX, EBX, ECX, and EDX, so you should push and pop those registers yourself.

Table 11-2 Win32 Console Functions.

| Function                                | Description                                                                              |
|-----------------------------------------|------------------------------------------------------------------------------------------|
| <code>AllocConsole</code>               | Allocates a new console for the calling process.                                         |
| <code>CreateConsoleScreenBuffer</code>  | Creates a console screen buffer.                                                         |
| <code>ExitProcess</code>                | Ends a process and all its threads.                                                      |
| <code>FillConsoleOutputAttribute</code> | Sets the text and background color attributes for a specified number of character cells. |
| <code>FillConsoleOutputCharacter</code> | Writes a character to the screen buffer a specified number of times.                     |
| <code>FlushConsoleInputBuffer</code>    | Flushes the console input buffer.                                                        |
| <code>FreeConsole</code>                | Detaches the calling process from its console.                                           |

Table 11-2 (Continued)

| Function                       | Description                                                                                                                |
|--------------------------------|----------------------------------------------------------------------------------------------------------------------------|
| GenerateConsoleCtrlEvent       | Sends a specified signal to a console process group that shares the console associated with the calling process.           |
| GetConsoleCP                   | Retrieves the input code page used by the console associated with the calling process.                                     |
| GetConsoleCursorInfo           | Retrieves information about the size and visibility of the cursor for the specified console screen buffer.                 |
| GetConsoleMode                 | Retrieves the current input mode of a console input buffer or the current output mode of a console screen buffer.          |
| GetConsoleOutputCP             | Retrieves the output code page used by the console associated with the calling process.                                    |
| GetConsoleScreenBufferInfo     | Retrieves information about the specified console screen buffer.                                                           |
| GetConsoleTitle                | Retrieves the title bar string for the current console window.                                                             |
| GetConsoleWindow               | Retrieves the window handle used by the console associated with the calling process.                                       |
| GetLargestConsoleWindowSize    | Retrieves the size of the largest possible console window.                                                                 |
| GetNumberOfConsoleInputEvents  | Retrieves the number of unread input records in the console's input buffer.                                                |
| GetNumberOfConsoleMouseButtons | Retrieves the number of buttons on the mouse used by the current console.                                                  |
| GetStdHandle                   | Retrieves a handle for the standard input, standard output, or standard error device.                                      |
| HandlerRoutine                 | An application-defined function used with the SetConsoleCtrlHandler function.                                              |
| PeekConsoleInput               | Reads data from the specified console input buffer without removing it from the buffer.                                    |
| ReadConsole                    | Reads character input from the console input buffer and removes it from the buffer.                                        |
| ReadConsoleInput               | Reads data from a console input buffer and removes it from the buffer.                                                     |
| ReadConsoleOutput              | Reads character and color attribute data from a rectangular block of character cells in a console screen buffer.           |
| ReadConsoleOutputAttribute     | Copies a specified number of foreground and background color attributes from consecutive cells of a console screen buffer. |
| ReadConsoleOutputCharacter     | Copies a number of characters from consecutive cells of a console screen buffer.                                           |
| ScrollConsoleScreenBuffer      | Moves a block of data in a screen buffer.                                                                                  |
| SetConsoleActiveScreenBuffer   | Sets the specified screen buffer to be the currently displayed console screen buffer.                                      |
| SetConsoleCP                   | Sets the input code page used by the console associated with the calling process.                                          |
| SetConsoleCtrlHandler          | Adds or removes an application-defined HandlerRoutine from the list of handler functions for the calling process.          |
| SetConsoleCursorInfo           | Sets the size and visibility of the cursor for the specified console screen buffer.                                        |
| SetConsoleCursorPosition       | Sets the cursor position in the specified console screen buffer.                                                           |

Table 11-2 (Continued)

| Function                    | Description                                                                                                               |
|-----------------------------|---------------------------------------------------------------------------------------------------------------------------|
| SetConsoleMode              | Sets the input mode of a console's input buffer or the output mode of a console screen buffer.                            |
| SetConsoleOutputCP          | Sets the output code page used by the console associated with the calling process.                                        |
| SetConsoleScreenBufferSize  | Changes the size of the specified console screen buffer.                                                                  |
| SetConsoleTextAttribute     | Sets the foreground (text) and background color attributes of characters written to the screen buffer.                    |
| SetConsoleTitle             | Sets the title bar string for the current console window.                                                                 |
| SetConsoleWindowInfo        | Sets the current size and position of a console screen buffer's window.                                                   |
| SetStdHandle                | Sets the handle for the standard input, standard output, or standard error device.                                        |
| WriteConsole                | Writes a character string to a console screen buffer beginning at the current cursor location.                            |
| WriteConsoleInput           | Writes data directly to the console input buffer.                                                                         |
| WriteConsoleOutput          | Writes character and color attribute data to a specified rectangular block of character cells in a console screen buffer. |
| WriteConsoleOutputAttribute | Copies a number of foreground and background color attributes to consecutive cells of a console screen buffer.            |
| WriteConsoleOutputCharacter | Copies a number of characters to consecutive cells of a console screen buffer.                                            |

### 11.1.3 Displaying a Message Box

One of the easiest ways to generate output in a Win32 application is to call the **MessageBoxA** function:

```

MessageBoxA PROTO,
    hWnd:DWORD,           ; handle to window (can be null)
    lpText:PTR BYTE,      ; string, inside of box
    lpCaption:PTR BYTE,   ; string, dialog box title
    uType:DWORD           ; contents and behavior

```

In console-based applications, you can set *hWnd* to `NULL`, indicating that the message box is not associated with a containing or parent window. The *lpText* parameter is a pointer to the null-terminated string that you want to put in the message box. The *lpCaption* parameter points to a null-terminated string for the dialog box title. The *uType* parameter specifies the dialog box contents and behavior.

**Contents and Behavior** The *uType* parameter holds a bit-mapped integer combining three types of options: buttons to display, icons, and default button choice. Several button combinations are possible:

- `MB_OK`
- `MB_OKCANCEL`
- `MB_YESNO`
- `MB_YESNOCANCEL`

- MB\_RETRYCANCEL
- MB\_ABORTRETRYIGNORE
- MB\_CANCELTRYCONTINUE

**Default Button** You can choose which button will be automatically selected if the user presses the Enter key. The choices are MB\_DEFBUTTON1 (the default), MB\_DEFBUTTON2, MB\_DEFBUTTON3, and MB\_DEFBUTTON4. Buttons are numbered from the left, starting with 1.

**Icons** Four icon choices are available. Sometimes more than one constant produces the same icon:

- Stop-sign: MB\_ICONSTOP, MB\_ICONHAND, or MB\_ICONERROR
- Question mark (?): MB\_ICONQUESTION
- Information symbol (i): MB\_ICONINFORMATION, MB\_ICONASTERISK
- Exclamation point (!): MB\_ICONEXCLAMATION, MB\_ICONWARNING

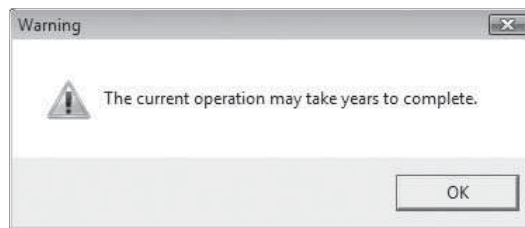
**Return Value** If MessageBoxA fails, it returns zero. Otherwise, it returns an integer specifying which button the user clicked when closing the box. The choices are IDABORT, IDCANCEL, IDCONTINUE, IDIGNORE, IDNO, IDOK, IDRETRY, IDTRYAGAIN, and IDYES. All are defined in Smallwin.inc.

SmallWin.inc redefines **MessageBoxA** as **MessageBox**, which seems a more user-friendly name.

If you want your message box window to float above all other windows on your desktop, add the MB\_SYSTEMMODAL option to the values you pass to the last argument (the uType parameter).

### Demonstration Program

We will demonstrate a short program that demonstrates some capabilities of the MessageBoxA function. The first function call displays a warning message:

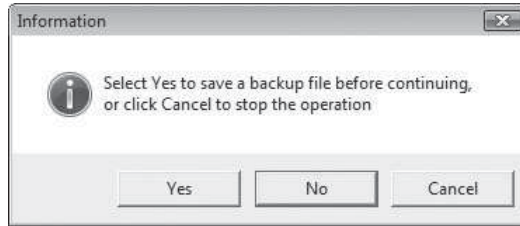


The second function call displays a question icon and Yes/No buttons. If the user selects the Yes button, the program could use the return value to select a course of action:

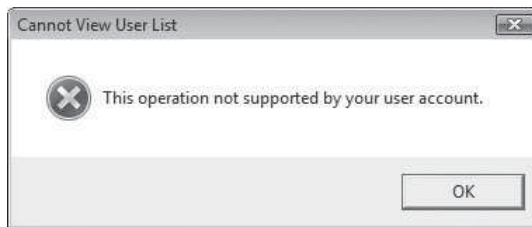




The third function call displays an information icon with three buttons:



The fourth function call displays a stop icon with an OK button:



### Program Listing

Following is a complete listing of a MessageBox demonstration program. The function named MessageBox is an alias for the MessageBoxA function, so we will use the simpler name:

```
; Demonstrate MessageBoxA          (MessageBox.asm)
INCLUDE Irvine32.inc
.data
captionW    BYTE "Warning",0
warningMsg  BYTE "The current operation may take years "
            BYTE "to complete.",0

captionQ    BYTE "Question",0
questionMsg BYTE "A matching user account was not found."
            BYTE 0dh,0ah,"Do you wish to continue?",0

captionC    BYTE "Information",0
infoMsg     BYTE "Select Yes to save a backup file "
            BYTE "before continuing,",0dh,0ah
            BYTE "or click Cancel to stop the operation",0

captionH    BYTE "Cannot View User List",0
haltMsg     BYTE "This operation not supported by your "
            BYTE "user account.",0

.code
main PROC

; Display Exclamation icon with OK button
    INVOKE MessageBox, NULL, ADDR warningMsg,
```

```

        ADDR captionW,
        MB_OK + MB_ICONEXCLAMATION
; Display Question icon with Yes/No buttons
    INVOKE MessageBox, NULL, ADDR questionMsg,
        ADDR captionQ, MB_YESNO + MB_ICONQUESTION
; interpret the button clicked by the user
    cmp  eax, IDYES          ; YES button clicked?
; Display Information icon with Yes/No/Cancel buttons
    INVOKE MessageBox, NULL, ADDR infoMsg,
        ADDR captionC, MB_YESNOCANCEL + MB_ICONINFORMATION \
        + MB_DEFBUTTON2
; Display stop icon with OK button
    INVOKE MessageBox, NULL, ADDR haltMsg,
        ADDR captionH,
        MB_OK + MB_ICONSTOP
    exit
main ENDP
END main

```

#### 11.1.4 Console Input

By now, you have used the `ReadString` and `ReadChar` procedures from the book's link library quite a few times. They were designed to be simple and straightforward, so you could concentrate on other issues. Both procedures are wrappers around `ReadConsole`, a Win32 function. (A *wrapper* procedure hides some of the details of another procedure.)

**Console Input Buffer** The Win32 console has an input buffer containing an array of input event records. Each input event, such as a keystroke, mouse movement, or mouse-button click, creates an input record in the console's input buffer. High-level input functions such as `ReadConsole` filter and process the input data, returning only a stream of characters.

#### **ReadConsole Function**

The **ReadConsole** function provides a convenient way to read text input and put it in a buffer. Here is the prototype:

```

ReadConsole PROTO,
    hConsoleInput:HANDLE,          ; input handle
    lpBuffer:PTR BYTE,            ; pointer to buffer
    nNumberOfCharsToRead:DWORD,   ; number of chars to read
    lpNumberOfCharsRead:PTR DWORD, ; ptr to num bytes read
    lpReserved:DWORD              ; (not used)

```

*hConsoleInput* is a valid console input handle returned by the **GetStdHandle** function. The *lpBuffer* parameter is the offset of a character array. *nNumberOfCharsToRead* is a 32-bit integer specifying the maximum number of characters to read. *lpNumberOfCharsRead* is a pointer to a doubleword that permits the function to fill in, when it returns, a count of the number of characters placed in the buffer. The last parameter is not used, so pass the value zero.

When calling `ReadConsole`, include two extra bytes in your input buffer to hold the end-of-line characters. If you want the input buffer to contain a null-terminated string, replace the byte containing `0Dh` with a null byte. This is exactly what is done by the `ReadString` procedure from `Irvine32.lib`.

*Note:* Win32 API functions do not preserve the EAX, EBX, ECX, and EDX registers.

*Example Program* To read characters entered by the user, call `GetStdHandle` to get the console's standard input handle and call `ReadConsole`, using the same input handle. The following `ReadConsole` program demonstrates the technique. Notice that Win32 API calls are compatible with the `Irvine32` library, so we are able to call `DumpRegs` at the same time we call Win32 functions:

```

; Read From the Console          (ReadConsole.asm)
INCLUDE Irvine32.inc
BufSize = 80

.data
buffer BYTE BufSize DUP(?,0,0)
stdInHandle HANDLE ?
bytesRead DWORD ?

.code
main PROC
    ; Get handle to standard input
    INVOKE GetStdHandle, STD_INPUT_HANDLE
    mov stdInHandle,eax

    ; Wait for user input
    INVOKE ReadConsole, stdInHandle, ADDR buffer,
        BufSize, ADDR bytesRead, 0

    ; Display the buffer
    mov esi,OFFSET buffer
    mov ecx,bytesRead
    mov ebx,TYPE buffer
    call DumpMem

    exit
main ENDP
END main

```

If the user enters “`abcdefg`”, the program generates the following output. Nine bytes are inserted in the buffer: “`abcdefg`” plus `0Dh` and `0Ah`, the end-of-line characters inserted when the user pressed the Enter key. `bytesRead` equals 9:

```

Dump of offset 00404000
-----
61 62 63 64 65 66 67 0D 0A

```

### Checking for Errors

If a Windows API function returns an error value (such as `NULL`), you can call the **GetLastError** API function to get more information about the error. It returns a 32-bit integer error code in `EAX`:

```
.data
messageId DWORD ?
.code
call GetLastError
mov  messageId,eax
```

MS-Windows has a large number of error codes, so you'll probably want to obtain a message string explaining the error. To do that, call the **FormatMessage** function:

```
FormatMessage PROTO,          ; format a message
    dwFlags:DWORD,          ; formatting options
    lpSource:DWORD,         ; location of message def
    dwMsgID:DWORD,          ; message identifier
    dwLanguageID:DWORD,     ; language identifier
    lpBuffer:PTR BYTE,      ; ptr to buffer receiving string
    nSize:DWORD,            ; buffer size
    va_list:DWORD           ; pointer to list of arguments
```

Its parameters are somewhat complicated, so you will have to read the SDK documentation to get the full picture. Following is a brief listing of the values we find most useful. All are input parameters except *lpBuffer*, an output parameter:

- *dwFlags*, a doubleword integer that holds formatting options, including how to interpret the *lpSource* parameter. It specifies how to handle line breaks, as well as the maximum width of a formatted output line. The recommended values are `FORMAT_MESSAGE_ALLOCATE_BUFFER` and `FORMAT_MESSAGE_FROM_SYSTEM`
- *lpSource*, a pointer to the location of the message definition. Given the *dwFlags* setting we recommend, set *lpSource* to `NULL` (0).
- *dwMsgID*, the integer doubleword returned by calling `GetLastError`.
- *dwLanguageID*, a language identifier. If you set it to zero, the message will be language neutral, or it will correspond to the user's default locale.
- *lpBuffer* (*output parameter*), a pointer to a buffer that receives the null-terminated message string. Because we use the `FORMAT_MESSAGE_ALLOCATE_BUFFER` option, the buffer is allocated automatically.
- *nSize*, which can be used to specify a buffer to hold the message string. You can set this parameter to 0 if you use the options for *dwFlags* suggested above.
- *va\_list*, a pointer to an array of values that can be inserted in a formatted message. Because we are not formatting error messages, this parameter can be `NULL` (0).

Following is a sample call to `FormatMessage`:

```
.data
messageId DWORD ?
pErrorMsg DWORD ?          ; points to error message
.code
```

```

call GetLastError
mov  messageId,eax
INVOKE FormatMessage, FORMAT_MESSAGE_ALLOCATE_BUFFER + \
        FORMAT_MESSAGE_FROM_SYSTEM, NULL, messageId, 0,
        ADDR pErrorMsg, 0, NULL

```

After calling `FormatMessage`, call **LocalFree** to release the storage allocated by `FormatMessage`:

```
INVOKE LocalFree, pErrorMsg
```

*WriteWindowsMsg* The Irvine32 library contains the following **WriteWindowsMsg** procedure, which encapsulates the message-handling details:

```

;-----
WriteWindowsMsg PROC USES eax edx
;
; Displays a string containing the most recent error
; generated by MS-Windows.
; Receives: nothing
; Returns: nothing
;-----
.data
WriteWindowsMsg_1 BYTE "Error ",0
WriteWindowsMsg_2 BYTE ": ",0
pErrorMsg DWORD ?           ; points to error message
messageId DWORD ?
.code
    call  GetLastError
    mov  messageId,eax

; Display the error number.
    mov  edx,OFFSET WriteWindowsMsg_1
    call WriteString
    call WriteDec
    mov  edx,OFFSET WriteWindowsMsg_2
    call WriteString

; Get the corresponding message string.
    INVOKE FormatMessage, FORMAT_MESSAGE_ALLOCATE_BUFFER + \
        FORMAT_MESSAGE_FROM_SYSTEM, NULL, messageId, NULL,
        ADDR pErrorMsg, NULL, NULL

; Display the error message generated by MS-Windows.
    mov  edx,pErrorMsg
    call WriteString

; Free the error message string.
    INVOKE LocalFree, pErrorMsg

    ret
WriteWindowsMsg ENDP

```

### Single-Character Input

Single-character input in console mode is a little tricky. MS-Windows provides a device driver for the currently installed keyboard. When a key is pressed, an 8-bit *scan code* is transmitted to the computer's keyboard port. When the key is released, a second scan code is transmitted. MS-Windows uses a device driver program to translate the scan code into a 16-bit *virtual-key code*, a device-independent value defined by MS-Windows that identifies the key's purpose. A message is created by MS-Windows containing the scan code, the virtual-key code, and other related information. The message is placed in the MS-Windows message queue, eventually finding its way to the currently executing program thread (which we identify by the console input handle). If you would like to learn more about the keyboard input process, read the *About Keyboard Input* topic in the Platform SDK documentation. For a list of virtual key constants, see the *VirtualKeys.inc* file in the book's `\Examples\ch11` directory.

**Irvine32 Keyboard Procedures** The Irvine32 library has two related procedures:

- **ReadChar** waits for an ASCII character to be typed at the keyboard and returns the character in AL.
- The **ReadKey** procedure performs a no-wait keyboard check. If no key is waiting in the console input buffer, the Zero flag is set. If a key is found, the Zero flag is clear and AL contains either zero or an ASCII code. The upper halves of EAX and EDX are overwritten.

In **ReadKey**, if AL contains zero, the user may have pressed a special key (function key, cursor arrow, etc.). The AH register contains the keyboard scan code, which you can match to the list of keyboard keys on the facing page inside the front cover of this book. DX contains the virtual-key code, and EBX contains state information about the states of the keyboard control keys. See Table 11-3 for a list of control key values. After calling **ReadKey**, you can use the **TEST** instruction to check for various key values. The implementation of **ReadKey** is somewhat long, so we will not show it here. You can view it in the `Irvine32.asm` file in the book's `\Examples\Lib32` folder.

Table 11-3 Keyboard Control Key State Values.

| Value              | Meaning                        |
|--------------------|--------------------------------|
| CAPSLock_ON        | The CAPS LOCK light is on.     |
| ENHANCED_KEY       | The key is enhanced.           |
| LEFT_ALT_PRESSED   | The left ALT key is pressed.   |
| LEFT_CTRL_PRESSED  | The left CTRL key is pressed.  |
| NUMLOCK_ON         | The NUM LOCK light is on.      |
| RIGHT_ALT_PRESSED  | The right ALT key is pressed.  |
| RIGHT_CTRL_PRESSED | The right CTRL key is pressed. |
| SCROLLLOCK_ON      | The SCROLL LOCK light is on.   |
| SHIFT_PRESSED      | The SHIFT key is pressed.      |

**ReadKey Test Program** The following program tests ReadKey by waiting for a keypress and then reporting whether or not the CapsLock key is down. As we mentioned in Chapter 5, you should include a delay factor when calling ReadKey to allow time for MS-Windows to process its message loop:

```

; Testing ReadKey                                (TestReadkey.asm)
INCLUDE Irvine32.inc
INCLUDE Macros.inc

.code
main PROC
L1: mov  eax,10                                ; delay for msg processing
    call Delay
    call ReadKey                               ; wait for a keypress
    jz   L1

    test ebx,CAPSLOCK_ON
    jz   L2
    mWrite <"CapsLock is ON",0dh,0ah>
    jmp  L3
L2: mWrite <"CapsLock is OFF",0dh,0ah>
L3: exit
main ENDP
END main

```

### Getting the Keyboard State

You can test the state of individual keyboard keys to find out which are currently pressed. Call the **GetKeyState** API function.

```
GetKeyState PROTO, nVirtKey:DWORD
```

Pass it a virtual key value, such as the ones identified by Table 11-4. Your program must test the value returned in EAX, as indicated by the same table.

The following example program demonstrates GetKeyState by checking the states of the NumLock and Left Shift keys:

```

; Keyboard Toggle Keys                            (Keybd.asm)
INCLUDE Irvine32.inc
INCLUDE Macros.inc

; GetKeyState sets bit 0 in EAX if a toggle key is
; currently on (CapsLock, NumLock, ScrollLock).
; It sets the high bit of EAX if the specified key is
; currently down.

.code
main PROC

    INVOKE GetKeyState, VK_NUMLOCK
    test al,1
    .IF !Zero?

```

```

        mWrite <"The NumLock key is ON",0dh,0ah>
    .ENDIF

    INVOKE GetKeyState, VK_LSHIFT
    test eax,80000000h
    .IF !Zero?
        mWrite <"The Left Shift key is currently DOWN",0dh,0ah>
    .ENDIF

    exit
main ENDP
END main

```

Table 11.4 Testing Keys with GetKeyState.

| Key         | Virtual Key Symbol | Bit to Test in EAX |
|-------------|--------------------|--------------------|
| NumLock     | VK_NUMLOCK         | 0                  |
| Scroll Lock | VK_SCROLL          | 0                  |
| Left Shift  | VK_LSHIFT          | 15                 |
| Right Shift | VK_RSHIFT          | 15                 |
| Left Ctrl   | VK_LCONTROL        | 15                 |
| Right Ctrl  | VK_RCONTROL        | 15                 |
| Left Menu   | VK_LMENU           | 15                 |
| Right Menu  | VK_RMENU           | 15                 |

### 11.1.5 Console Output

In earlier chapters we tried to make console output as simple as possible. As far back as Chapter 5, the **WriteString** procedure in the Irvine32 link library required only a single argument, the offset of a string in EDX. It turns out that WriteString is actually a wrapper around a more detailed call to a Win32 function named **WriteConsole**.

In this chapter, however, you learn how to make direct calls to Win32 functions such as WriteConsole and WriteConsoleOutputCharacter. Direct calls require you to learn more details, but they also offer you more flexibility than the Irvine32 library procedures.

#### Data Structures

Several of the Win32 console functions use predefined data structures, including COORD and SMALL\_RECT. The COORD structure holds the coordinates of a character cell in the console screen buffer. The origin of the coordinate system (0,0) is at the top left cell:

```

COORD STRUCT
    X WORD ?
    Y WORD ?
COORD ENDS

```



The `SMALL_RECT` structure holds the upper left and lower right corners of a rectangle. It specifies screen buffer character cells in the console window:

```
SMALL_RECT STRUCT
    Left   WORD ?
    Top    WORD ?
    Right  WORD ?
    Bottom WORD ?
SMALL_RECT ENDS
```

### **WriteConsole Function**

The **WriteConsole** function writes a string to the console window at the current cursor position and leaves the cursor just past the last character written. It acts upon standard ASCII control characters such as *tab*, *carriage return*, and *line feed*. The string does not have to be null-terminated. Here is the function prototype:

```
WriteConsole PROTO,
    hConsoleOutput:HANDLE,
    lpBuffer:PTR BYTE,
    nNumberOfCharsToWrite:DWORD,
    lpNumberOfCharsWritten:PTR DWORD,
    lpReserved:DWORD
```

*hConsoleOutput* is the console output stream handle; *lpBuffer* is a pointer to the array of characters you want to write; *nNumberOfCharsToWrite* holds the array length; *lpNumberOfCharsWritten* points to an integer assigned the number of bytes actually written when the function returns. The last parameter is not used, so set it to zero.

### **Example Program: Console1**

The following program, *Console1.asm*, demonstrates the **GetStdHandle**, **ExitProcess**, and **WriteConsole** functions by writing a string to the console window:

```
; Win32 Console Example #1                                (Console1.asm)
; This program calls the following Win32 Console functions:
; GetStdHandle, ExitProcess, WriteConsole

INCLUDE Irvine32.inc

.data
endl EQU <0dh,0ah>           ; end of line sequence
message LABEL BYTE
    BYTE "This program is a simple demonstration of"
    BYTE "console mode output, using the GetStdHandle"
    BYTE "and WriteConsole functions.",endl
messageSize DWORD ($ - message)

consoleHandle HANDLE 0       ; handle to standard output device
bytesWritten  DWORD ?        ; number of bytes written

.code
main PROC
    ; Get the console output handle:
```

```

        INVOKE GetStdHandle, STD_OUTPUT_HANDLE
        mov consoleHandle,eax

; Write a string to the console:
        INVOKE WriteConsole,
            consoleHandle,          ; console output handle
            ADDR message,          ; string pointer
            messageSize,          ; string length
            ADDR bytesWritten,    ; returns num bytes written
            0                      ; not used

        INVOKE ExitProcess,0
main ENDP
END main

```

The program produces the following output:

This program is a simple demonstration of console mode output, using the `GetStdHandle` and `WriteConsole` functions.

### ***WriteConsoleOutputCharacter Function***

The **`WriteConsoleOutputCharacter`** function copies an array of characters to consecutive cells of the console screen buffer, beginning at a specified location. Here is the prototype:

```

WriteConsoleOutputCharacter PROTO,
    hConsoleOutput:HANDLE,          ; console output handle
    lpCharacter:PTR BYTE,          ; pointer to buffer
    nLength:DWORD,                ; size of buffer
    dwWriteCoord:COORD,           ; first cell coordinates
    lpNumberOfCharsWritten:PTR DWORD ; output count

```

If the text reaches the end of a line, it wraps around. The attribute values in the screen buffer are not changed. If the function cannot write the characters, it returns zero. ASCII control codes such as *tab*, *carriage return*, and *line feed* are ignored.

## **11.1.6 Reading and Writing Files**

### ***CreateFile Function***

The **`CreateFile`** function either creates a new file or opens an existing file. If successful, it returns a handle to the open file; otherwise, it returns a special constant named `INVALID_HANDLE_VALUE`. Here is the prototype:

```

CreateFile PROTO,
    lpFilename:PTR BYTE,          ; ptr to filename
    dwDesiredAccess:DWORD,       ; access mode
    dwShareMode:DWORD,          ; share mode
    lpSecurityAttributes:DWORD,  ; ptr security attrib
    dwCreationDisposition:DWORD, ; file creation options
    dwFlagsAndAttributes:DWORD,  ; file attributes
    hTemplateFile:DWORD          ; handle to template file

```

The parameters are described in Table 11-5. The return value is zero if the function fails.

Table 11-5 CreateFile Parameters.

| Parameter             | Description                                                                                                                                                                     |
|-----------------------|---------------------------------------------------------------------------------------------------------------------------------------------------------------------------------|
| lpFileName            | Points to a null-terminated string containing either a partial or a fully qualified filename ( <i>drive:\path\filename</i> ).                                                   |
| dwDesiredAccess       | Specifies how the file will be accessed (reading or writing).                                                                                                                   |
| dwShareMode           | Controls the ability for multiple programs to access the file while it is open.                                                                                                 |
| lpSecurityAttributes  | Points to a security structure controlling security rights.                                                                                                                     |
| dwCreationDisposition | Specifies what action to take when a file exists or does not exist.                                                                                                             |
| dwFlagsAndAttributes  | Holds bit flags specifying file attributes such as archive, encrypted, hidden, normal, system, and temporary.                                                                   |
| hTemplateFile         | Contains an optional handle to a template file that supplies file attributes and extended attributes for the file being created; when not using this parameter, set it to zero. |

*dwDesiredAccess* The *dwDesiredAccess* parameter lets you specify read access, write access, read/write access, or device query access to the file. Choose from the values listed in Table 11-6 or from a large set of specific flag values not listed here. (Search for *CreateFile* in the Platform SDK documentation).

Table 11-6 dwDesiredAccess Parameter Options.

| Value         | Meaning                                                                                                                                                            |
|---------------|--------------------------------------------------------------------------------------------------------------------------------------------------------------------|
| 0             | Specifies device query access to the object. An application can query device attributes without accessing the device, or it can check for the existence of a file. |
| GENERIC_READ  | Specifies read access to the object. Data can be read from the file, and the file pointer can be moved. Combine with GENERIC_WRITE for read/write access.          |
| GENERIC_WRITE | Specifies write access to the object. Data can be written to the file, and the file pointer can be moved. Combine with GENERIC_READ for read/write access.         |

*dwCreationDisposition* The *dwCreationDisposition* parameter specifies which action to take on files that exist and which action to take when files do not exist. Select one of the values in Table 11-7.

Table 11-7 dwCreationDisposition Parameter Options.

| Value         | Meaning                                                                                                                                                                                                                                                                                                                        |
|---------------|--------------------------------------------------------------------------------------------------------------------------------------------------------------------------------------------------------------------------------------------------------------------------------------------------------------------------------|
| CREATE_NEW    | Creates a new file. Requires setting the <i>dwDesiredAccess</i> parameter to GENERIC_WRITE. The function fails if the file already exists.                                                                                                                                                                                     |
| CREATE_ALWAYS | Creates a new file. If the file exists, the function overwrites the file, clears the existing attributes, and combines the file attributes and flags specified by the <i>attributes</i> parameter with the predefined constant FILE_ATTRIBUTE_ARCHIVE. Requires setting the <i>dwDesiredAccess</i> parameter to GENERIC_WRITE. |

Table 11-7 (Continued)

| Value             | Meaning                                                                                                                                                                                  |
|-------------------|------------------------------------------------------------------------------------------------------------------------------------------------------------------------------------------|
| OPEN_EXISTING     | Opens the file. The function fails if the file does not exist. May be used for reading from and/or writing to the file.                                                                  |
| OPEN_ALWAYS       | Opens the file if it exists. If the file does not exist, the function creates the file as if <i>CreationDisposition</i> were CREATE_NEW.                                                 |
| TRUNCATE_EXISTING | Opens the file. Once opened, the file is truncated to size zero. Requires setting the <i>dwDesiredAccess</i> parameter to GENERIC_WRITE. This function fails if the file does not exist. |

Table 11-8 lists the more commonly used values permitted in the *dwFlagsAndAttributes* parameter. (For a complete list, search for *CreateFile* in the online Microsoft documentation.) Any combination of the attributes is acceptable, except that all other file attributes override FILE\_ATTRIBUTE\_NORMAL. The values map to powers of 2, so you can use the assembly time OR operator or + operator to combine them into a single argument:

```
FILE_ATTRIBUTE_HIDDEN OR FILE_ATTRIBUTE_READONLY
FILE_ATTRIBUTE_HIDDEN + FILE_ATTRIBUTE_READONLY
```

Table 11-8 Selected FlagsAndAttributes Values.

| Attribute                | Meaning                                                                                           |
|--------------------------|---------------------------------------------------------------------------------------------------|
| FILE_ATTRIBUTE_ARCHIVE   | The file should be archived. Applications use this attribute to mark files for backup or removal. |
| FILE_ATTRIBUTE_HIDDEN    | The file is hidden. It is not to be included in an ordinary directory listing.                    |
| FILE_ATTRIBUTE_NORMAL    | The file has no other attributes set. This attribute is valid only if used alone.                 |
| FILE_ATTRIBUTE_READONLY  | The file is read only. Applications can read the file but cannot write to it or delete it.        |
| FILE_ATTRIBUTE_TEMPORARY | The file is being used for temporary storage.                                                     |

**Examples** The following examples are for illustrative purposes only, to show how you might create and open files. See the online Microsoft documentation for **CreateFile** to learn about the many available options:

- Open an existing file for reading (input):

```
INVOKE CreateFile,
    ADDR filename,           ; ptr to filename
    GENERIC_READ,           ; read from the file
    DO_NOT_SHARE,          ; share mode
    NULL,                   ; ptr to security attributes
    OPEN_EXISTING,         ; open an existing file
    FILE_ATTRIBUTE_NORMAL,  ; normal file attribute
    0                       ; not used
```

- Open an existing file for writing (output). Once the file is open, we could write over existing data or append new data to the file by moving the file pointer to the end (see `SetFilePointer`, Section 11.1.6):

```

INVOKE CreateFile,
    ADDR filename,
    GENERIC_WRITE,           ; write to the file
    DO_NOT_SHARE,
    NULL,
    OPEN_EXISTING,         ; file must exist
    FILE_ATTRIBUTE_NORMAL,
    0

```

- Create a new file with normal attributes, erasing any existing file by the same name:

```

INVOKE CreateFile,
    ADDR filename,
    GENERIC_WRITE,           ; write to the file
    DO_NOT_SHARE,
    NULL,
    CREATE_ALWAYS,         ; overwrite existing file
    FILE_ATTRIBUTE_NORMAL,
    0

```

- Create a new file if the file does not already exist; otherwise, open the existing file for output:

```

INVOKE CreateFile,
    ADDR filename,
    GENERIC_WRITE,           ; write to the file
    DO_NOT_SHARE,
    NULL,
    CREATE_NEW,             ; don't erase existing file
    FILE_ATTRIBUTE_NORMAL,
    0

```

(The constants named `DO_NOT_SHARE` and `NULL` are defined in the *SmallWin.inc* include file, which is automatically included by *Irvine32.inc*.)

### **CloseHandle Function**

The **CloseHandle** function closes an open object handle. Its prototype is

```

CloseHandle PROTO,
    hObject:HANDLE           ; handle to object

```

You can use `CloseHandle` to close a currently open file handle. The return value is zero if the function fails.

### **ReadFile Function**

The **ReadFile** function reads text from an input file. Here is the prototype:

```

ReadFile PROTO,
    hFile:HANDLE,                ; input handle
    lpBuffer:PTR BYTE,          ; ptr to buffer
    nNumberOfBytesToRead:DWORD, ; num bytes to read
    lpNumberOfBytesRead:PTR DWORD, ; bytes actually read
    lpOverlapped:PTR DWORD      ; ptr to asynch info

```

The *hFile* parameter is an open file handle returned by **CreateFile**; *lpBuffer* points to a buffer that receives data read from the file; *nNumberOfBytesToRead* specifies the maximum number of bytes to read from the file; *lpNumberOfBytesRead* points to an integer indicating the number of bytes actually read when the function returns; *lpOverlapped* should be set to NULL (0) for synchronous reading (which we use). The return value is zero if the function fails.

If called more than once on the same open file handle, **ReadFile** remembers where it last finished reading and reads from that point on. In other words, it maintains an internal pointer to the current position in the file. **ReadFile** can also run in asynchronous mode, meaning that the calling program does not wait for the read operation to finish.

### **WriteFile Function**

The **WriteFile** function writes data to a file, using an output handle. The handle can be the screen buffer handle, or it can be the one assigned to a text file. The function starts writing data to the file at the position indicated by the file's internal position pointer. After the write operation has been completed, the file's position pointer is adjusted by the number of bytes actually written. Here is the function prototype:

```

WriteFile PROTO,
    hFile:HANDLE,                ; output handle
    lpBuffer:PTR BYTE,          ; pointer to buffer
    nNumberOfBytesToWrite:DWORD, ; size of buffer
    lpNumberOfBytesWritten:PTR DWORD, ; num bytes written
    lpOverlapped:PTR DWORD      ; ptr to asynch info

```

*hFile* is a handle to a previously opened file; *lpBuffer* points to a buffer holding the data written to the file; *nNumberOfBytesToWrite* specifies how many bytes to write to the file; *lpNumberOfBytesWritten* points to an integer that specifies the number of bytes actually written after the function executes; and *lpOverlapped* should be set to NULL for synchronous operation. The return value is zero if the function fails.

### **SetFilePointer Function**

The **SetFilePointer** function moves the position pointer of an open file. This function can be used to append data to a file or to perform random-access record processing:

```

SetFilePointer PROTO,
    hFile:HANDLE,                ; file handle
    lDistanceToMove:SDWORD,      ; bytes to move pointer
    lpDistanceToMoveHigh:PTR SDWORD, ; ptr bytes to move, high
    dwMoveMethod:DWORD          ; starting point

```

The return value is zero if the function fails. *dwMoveMethod* specifies the starting point for moving the file pointer, which is selected from three predefined symbols: FILE\_BEGIN, FILE\_CURRENT, and FILE\_END. The distance itself is a 64-bit signed integer value, divided into two parts:

- *lpDistanceToMove*: the lower 32 bits
- *lpDistanceToMoveHigh*: a pointer to a variable containing the upper 32 bits

If *lpDistanceToMoveHigh* is null, only the value in *lpDistanceToMove* is used to move the file pointer. For example, the following code prepares to append to the end of a file:

```

INVOKE SetFilePointer,
    fileHandle,          ; file handle
    0,                  ; distance low
    0,                  ; distance high
    FILE_END            ; move method

```

See the *AppendFile.asm* program.

### 11.1.7 File I/O in the Irvine32 Library

The Irvine32 library contains a few simplified procedures for file input/output, which we documented in Chapter 5. The procedures are wrappers around the Win32 API functions we have described in the current chapter. The following source code lists CreateOutputFile, OpenFile, WriteToFile, ReadFromFile, and CloseFile:

```

;-----
CreateOutputFile PROC
;
; Creates a new file and opens it in output mode.
; Receives: EDX points to the filename.
; Returns: If the file was created successfully, EAX
;         contains a valid file handle. Otherwise, EAX
;         equals INVALID_HANDLE_VALUE.
;-----
    INVOKE CreateFile,
        edx, GENERIC_WRITE, DO_NOT_SHARE, NULL,
        CREATE_ALWAYS, FILE_ATTRIBUTE_NORMAL, 0
    ret
CreateOutputFile ENDP

;-----
OpenFile PROC
;
; Opens a new text file and opens for input.
; Receives: EDX points to the filename.
; Returns: If the file was opened successfully, EAX
;         contains a valid file handle. Otherwise, EAX equals
;         INVALID_HANDLE_VALUE.
;-----
    INVOKE CreateFile,
        edx, GENERIC_READ, DO_NOT_SHARE, NULL,

```

```

        OPEN_EXISTING, FILE_ATTRIBUTE_NORMAL, 0
    ret
OpenFile ENDP

;-----
WriteToFile PROC
;
; Writes a buffer to an output file.
; Receives: EAX = file handle, EDX = buffer offset,
;   ECX = number of bytes to write
; Returns: EAX = number of bytes written to the file.
; If the value returned in EAX is less than the
; argument passed in ECX, an error likely occurred.
;-----
.data
WriteToFile_1 DWORD ?           ; number of bytes written
.code
    INVOKE WriteFile,           ; write buffer to file
        eax,                    ; file handle
        edx,                    ; buffer pointer
        ecx,                    ; number of bytes to write
        ADDR WriteToFile_1,     ; number of bytes written
        0                        ; overlapped execution flag
    mov eax,WriteToFile_1      ; return value
    ret
WriteToFile ENDP

;-----
ReadFromFile PROC
;
; Reads an input file into a buffer.
; Receives: EAX = file handle, EDX = buffer offset,
;   ECX = number of bytes to read
; Returns: If CF = 0, EAX = number of bytes read; if
;   CF = 1, EAX contains the system error code returned
;   by the GetLastError Win32 API function.
;-----
.data
ReadFromFile_1 DWORD ?         ; number of bytes read
.code
    INVOKE ReadFile,           ; file handle
        eax,                    ; buffer pointer
        edx,                    ; max bytes to read
        ADDR ReadFromFile_1,    ; number of bytes read
        0                        ; overlapped execution flag
    mov eax,ReadFromFile_1
    ret
ReadFromFile ENDP

;-----
CloseFile PROC

```



```

;
; Closes a file using its handle as an identifier.
; Receives: EAX = file handle
; Returns: EAX = nonzero if the file is successfully
;   closed.
;-----
        INVOKE CloseHandle, eax
        ret
CloseFile ENDP

```

### 11.1.8 Testing the File I/O Procedures

#### **CreateFile Program Example**

The following program creates a file in output mode, asks the user to enter some text, writes the text to the output file, reports the number of bytes written, and closes the file. It checks for errors after attempting to create the file:

```

; Creating a File                (CreateFile.asm)
INCLUDE Irvine32.inc
BUFFER_SIZE = 501
.data
buffer BYTE BUFFER_SIZE DUP(?)
filename BYTE "output.txt",0
fileHandle HANDLE ?
stringLength DWORD ?
bytesWritten DWORD ?
str1 BYTE "Cannot create file",0dh,0ah,0
str2 BYTE "Bytes written to file [output.txt]:",0
str3 BYTE "Enter up to 500 characters and press"
      BYTE "[Enter]: ",0dh,0ah,0
.code
main PROC
; Create a new text file.
    mov  edx,OFFSET filename
    call CreateOutputFile
    mov  fileHandle,eax

; Check for errors.
    cmp  eax,INVALID_HANDLE_VALUE ; error found?
    jne  file_ok                  ; no: skip
    mov  edx,OFFSET str1          ; display error
    call WriteString
    jmp  quit
file_ok:

; Ask the user to input a string.
    mov  edx,OFFSET str3          ; "Enter up to ...."
    call WriteString
    mov  ecx,BUFFER_SIZE         ; Input a string
    mov  edx,OFFSET buffer

```

```

        call ReadString
        mov  stringLength,eax          ; counts chars entered
; Write the buffer to the output file.
        mov  eax,fileHandle
        mov  edx,OFFSET buffer
        mov  ecx,stringLength
        call WriteToFile
        mov  bytesWritten,eax        ; save return value
        call CloseFile

; Display the return value.
        mov  edx,OFFSET str2          ; "Bytes written"
        call WriteString
        mov  eax,bytesWritten
        call WriteDec
        call Crlf

quit:
        exit
main ENDP
END main

```

### ***ReadFile Program Example***

The following program opens a file for input, reads its contents into a buffer, and displays the buffer. All procedures are called from the Irvine32 library:

```

; Reading a File                                (ReadFile.asm)
; Opens, reads, and displays a text file using
; procedures from Irvine32.lib.

INCLUDE Irvine32.inc
INCLUDE macros.inc
BUFFER_SIZE = 5000

.data
buffer BYTE BUFFER_SIZE DUP(?)
filename BYTE 80 DUP(0)
fileHandle HANDLE ?

.code
main PROC

; Let user input a filename.
    mWrite "Enter an input filename: "
    mov  edx,OFFSET filename
    mov  ecx,SIZEOF filename
    call ReadString

; Open the file for input.
    mov  edx,OFFSET filename
    call OpenInputFile
    mov  fileHandle,eax

; Check for errors.

```

```

    cmp    eax,INVALID_HANDLE_VALUE    ; error opening file?
    jne    file_ok                      ; no: skip
    mWrite <"Cannot open file",0dh,0ah>
    jmp    quit                          ; and quit
file_ok:

; Read the file into a buffer.
    mov    edx,OFFSET buffer
    mov    ecx,BUFFER_SIZE
    call  ReadFromFile
    jnc    check_buffer_size            ; error reading?
    mWrite "Error reading file. "      ; yes: show error message
    call  WriteWindowsMsg
    jmp    close_file

check_buffer_size:
    cmp    eax,BUFFER_SIZE              ; buffer large enough?
    jb     buf_size_ok                  ; yes
    mWrite <"Error: Buffer too small for the file",0dh,0ah>
    jmp    quit                          ; and quit

buf_size_ok:
    mov    buffer[eax],0                 ; insert null terminator
    mWrite "File size: "
    call  WriteDec                       ; display file size
    call  Crlf

; Display the buffer.
    mWrite <"Buffer:",0dh,0ah,0dh,0ah>
    mov    edx,OFFSET buffer            ; display the buffer
    call  WriteString
    call  Crlf

close_file:
    mov    eax,fileHandle
    call  CloseFile

quit:
    exit
main ENDP
END main

```

The program reports an error if the file cannot be opened:

```

Enter an input filename: crazy.txt
Cannot open file

```

It reports an error if it cannot read from the file. Suppose, for example, a bug in the program used the wrong file handle when reading the file:

```

Enter an input filename: infile.txt
Error reading file. Error 6: The handle is invalid.

```

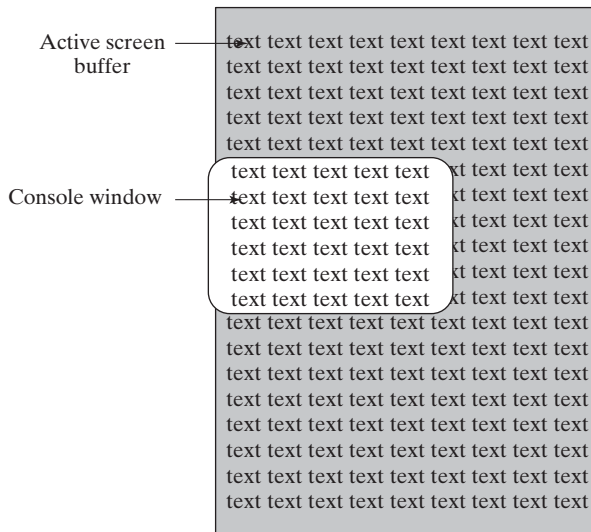
The buffer might be too small to hold the file:

```
Enter an input filename: infile.txt
Error: Buffer too small for the file
```

### 11.1.9 Console Window Manipulation

The Win32 API provides considerable control over the console window and its buffer. Figure 11-1 shows that the screen buffer can be larger than the number of lines currently displayed in the console window. The console window acts as a “viewport,” showing part of the buffer.

FIGURE 11-1 Screen buffer and console window.



Several functions affect the console window and its position relative to the screen buffer:

- **SetConsoleWindowInfo** sets the size and position of the console window relative to the screen buffer.
- **GetConsoleScreenBufferInfo** returns (among other things) the rectangle coordinates of the console window relative to the screen buffer.
- **SetConsoleCursorPosition** sets the cursor position to any location within the screen buffer; if that area is not visible, the console window is shifted to make the cursor visible.
- **ScrollConsoleScreenBuffer** moves some or all of the text within the screen buffer, which can affect the displayed text in the console window.

#### **SetConsoleTitle**

The **SetConsoleTitle** function lets you change the console window’s title. Here’s a sample:

```
.data
titleStr BYTE "Console title",0
.code
INVOKE SetConsoleTitle, ADDR titleStr
```

### **GetConsoleScreenBufferInfo**

The **GetConsoleScreenBufferInfo** function returns information about the current state of the console window. It has two parameters: a handle to the console screen, and a pointer to a structure that is filled in by the function:

```
GetConsoleScreenBufferInfo PROTO,
    hConsoleOutput:HANDLE,
    lpConsoleScreenBufferInfo:PTR CONSOLE_SCREEN_BUFFER_INFO
```

This is the `CONSOLE_SCREEN_BUFFER_INFO` structure:

```
CONSOLE_SCREEN_BUFFER_INFO STRUCT
    dwSize                COORD <>
    dwCursorPosition     COORD <>
    wAttributes          WORD ?
    srWindow             SMALL_RECT <>
    dwMaximumWindowSize  COORD <>
CONSOLE_SCREEN_BUFFER_INFO ENDS
```

*dwSize* returns the size of the screen buffer, in character columns and rows. *dwCursorPosition* returns the location of the cursor. Both fields are `COORD` structures. *wAttributes* returns the foreground and background colors of characters written to the console by functions such as **WriteConsole** and **WriteFile**. *srWindow* returns the coordinates of the console window relative to the screen buffer. *dwMaximumWindowSize* returns the maximum size of the console window, based on the current screen buffer size, font, and video display size. The following is a sample call to the function:

```
.data
consoleInfo CONSOLE_SCREEN_BUFFER_INFO <>
outHandle HANDLE ?
.code
INVOKE GetConsoleScreenBufferInfo, outHandle,
    ADDR consoleInfo
```

Figure 11-2 shows a sample of the structure data shown by the Microsoft Visual Studio debugger.

### **SetConsoleWindowInfo Function**

The **SetConsoleWindowInfo** function lets you set the size and position of the console window relative to its screen buffer. Following is its function prototype:

```
SetConsoleWindowInfo PROTO,
    hConsoleOutput:HANDLE,           ; screen buffer handle
    bAbsolute:DWORD,                ; coordinate type
    lpConsoleWindow:PTR SMALL_RECT  ; ptr to window rectangle
```

*bAbsolute* indicates how the coordinates in the structure pointed to by *lpConsoleWindow* are to be used. If *bAbsolute* is true, the coordinates specify the new upper left and lower right corners of the console window. If *bAbsolute* is false, the coordinates will be added to the current window coordinates.

FIGURE 11-2 CONSOLE\_SCREEN\_BUFFER\_INFO structure.

| Name                | Value                                         | Type                       |
|---------------------|-----------------------------------------------|----------------------------|
| consoleInfo         | {dwSize={X=0x0078 Y=0x0032} dwCursorPosition= | CONSOLE_SCREEN_BUFFER_INFO |
| dwSize              | {X=0x0078 Y=0x0032}                           | COORD                      |
| X                   | 0x0078                                        | unsigned short             |
| Y                   | 0x0032                                        | unsigned short             |
| dwCursorPosition    | {X=0x0014 Y=0x0005}                           | COORD                      |
| X                   | 0x0014                                        | unsigned short             |
| Y                   | 0x0005                                        | unsigned short             |
| wAttributes         | 0x0007                                        | unsigned short             |
| srWindow            | {Left=0x0000 Top=0x0000 Right=0x004f ...}     | SMALL_RECT                 |
| Left                | 0x0000                                        | unsigned short             |
| Top                 | 0x0000                                        | unsigned short             |
| Right               | 0x004f                                        | unsigned short             |
| Bottom              | 0x0018                                        | unsigned short             |
| dwMaximumWindowSize | {X=0x0078 Y=0x0032}                           | COORD                      |
| X                   | 0x0078                                        | unsigned short             |
| Y                   | 0x0032                                        | unsigned short             |

The following *Scroll.asm* program writes 50 lines of text to the screen buffer. It then resizes and repositions the console window, effectively scrolling the text backward. It uses the **SetConsoleWindowInfo** function:

```

; Scrolling the Console Window                                     (Scroll.asm)
INCLUDE Irvine32.inc

.data
message BYTE " : This line of text was written "
          BYTE "to the screen buffer",0dh,0ah
messageSize DWORD ($-message)

outHandle    HANDLE 0           ; standard output handle
bytesWritten DWORD ?           ; number of bytes written
lineNum      DWORD 0
windowRect   SMALL_RECT <0,0,60,11> ; left,top,right,bottom

.code
main PROC
    INVOKE GetStdHandle, STD_OUTPUT_HANDLE
    mov outHandle,eax

.REPEAT
    mov  eax,lineNum
    call WriteDec           ; display each line number
    INVOKE WriteConsole,
        outHandle,         ; console output handle
        ADDR message,     ; string pointer
        messageSize,      ; string length
        ADDR bytesWritten, ; returns num bytes written
        0                 ; not used
    inc lineNum           ; next line number
.UNTIL lineNum > 50

```

```

; Resize and reposition the console window relative to the
; screen buffer.
    INVOKE SetConsoleWindowInfo,
        outHandle,
        TRUE,
        ADDR windowRect          ; window rectangle

    call Readchar                 ; wait for a key
    call Clrscr                   ; clear the screen buffer
    call Readchar                 ; wait for a second key

    INVOKE ExitProcess,0
main ENDP
END main

```

It is best to run this program directly from MS-Windows Explorer or a command prompt rather than an integrated editor environment. Otherwise, the editor may affect the behavior and appearance of the console window. You must press a key twice at the end: once to clear the screen buffer and a second time to end the program.

### ***SetConsoleScreenBufferSize Function***

The **SetConsoleScreenBufferSize** function lets you set the screen buffer size to X columns by Y rows. Here is the prototype:

```

SetConsoleScreenBufferSize PROTO,
    hConsoleOutput:HANDLE,      ; handle to screen buffer
    dwSize:COORD                ; new screen buffer size

```

#### **11.1.10 Controlling the Cursor**

The Win32 API provides functions to set the cursor size, visibility, and screen location. An important data structure related to these functions is **CONSOLE\_CURSOR\_INFO**, which contains information about the console's cursor size and visibility:

```

CONSOLE_CURSOR_INFO STRUCT
    dwSize    DWORD ?
    bVisible  DWORD ?
CONSOLE_CURSOR_INFO ENDS

```

*dwSize* is the percentage (1 to 100) of the character cell filled by the cursor. *bVisible* equals TRUE (1) if the cursor is visible.

### ***GetConsoleCursorInfo Function***

The **GetConsoleCursorInfo** function returns the size and visibility of the console cursor. Pass it a pointer to a **CONSOLE\_CURSOR\_INFO** structure:

```

GetConsoleCursorInfo PROTO,
    hConsoleOutput:HANDLE,
    lpConsoleCursorInfo:PTR CONSOLE_CURSOR_INFO

```

By default, the cursor size is 25, indicating that the character cell is 25% filled by the cursor.

**SetConsoleCursorInfo Function**

The **SetConsoleCursorInfo** function sets the size and visibility of the cursor. Pass it a pointer to a **CONSOLE\_CURSOR\_INFO** structure:

```
SetConsoleCursorInfo PROTO,
    hConsoleOutput:HANDLE,
    lpConsoleCursorInfo:PTR CONSOLE_CURSOR_INFO
```

**SetConsoleCursorPosition**

The **SetConsoleCursorPosition** function sets the X, Y position of the cursor. Pass it a **COORD** structure and the console output handle:

```
SetConsoleCursorPosition PROTO,
    hConsoleOutput:DWORD,           ; input mode handle
    dwCursorPosition:COORD         ; screen X,Y coordinates
```

**11.1.11 Controlling the Text Color**

There are two ways to control the color of text in a console window. You can change the current text color by calling **SetConsoleTextAttribute**, which affects all subsequent text output to the console. Alternatively, you can set the attributes of specific cells by calling **WriteConsoleOutputAttribute**. The **GetConsoleScreenBufferInfo** function (Section 11.1.9) returns the current screen colors, along with other console information.

**SetConsoleTextAttribute Function**

The **SetConsoleTextAttribute** function lets you set the foreground and background colors for all subsequent text output to the console window. Here is its prototype:

```
SetConsoleTextAttribute PROTO,
    hConsoleOutput:HANDLE,           ; console output handle
    wAttributes:WORD                 ; color attribute
```

The color value is stored in the low-order byte of the *wAttributes* parameter.

**WriteConsoleOutputAttribute Function**

The **WriteConsoleOutputAttribute** function copies an array of attribute values to consecutive cells of the console screen buffer, beginning at a specified location. Here is the prototype:

```
WriteConsoleOutputAttribute PROTO,
    hConsoleOutput:DWORD,           ; output handle
    lpAttribute:PTR WORD,           ; write attributes
    nLength:DWORD,                  ; number of cells
    dwWriteCoord:COORD,             ; first cell coordinates
    lpNumberOfAttrsWritten:PTR DWORD ; output count
```

*lpAttribute* points to an array of attributes in which the low-order byte of each contains the color; *nLength* is the length of the array; *dwWriteCoord* is the starting screen cell to receive the attributes; and *lpNumberOfAttrsWritten* points to a variable that will hold the number of cells written.



### Example: Writing Text Colors

To demonstrate the use of colors and attributes, the *WriteColors.asm* program creates an array of characters and an array of attributes, one for each character. It calls **WriteConsoleOutputAttribute** to copy the attributes to the screen buffer and **WriteConsoleOutputCharacter** to copy the characters to the same screen buffer cells:

```

; Writing Text Colors                                (WriteColors.asm)
INCLUDE Irvine32.inc
.data
outHandle     HANDLE ?
cellsWritten  DWORD ?
xyPos        COORD <10,2>
; Array of character codes:
buffer       BYTE 1,2,3,4,5,6,7,8,9,10,11,12,13,14,15
             BYTE 16,17,18,19,20
BufSize     DWORD ($-buffer)
; Array of attributes:
attributes   WORD 0Fh,0Eh,0Dh,0Ch,0Bh,0Ah,9,8,7,6
             WORD 5,4,3,2,1,0F0h,0E0h,0D0h,0C0h,0B0h
.code
main PROC
; Get the Console standard output handle:
    INVOKE GetStdHandle,STD_OUTPUT_HANDLE
    mov outHandle,eax
; Set the colors of adjacent cells:
    INVOKE WriteConsoleOutputAttribute,
        outHandle, ADDR attributes,
        BufSize, xyPos, ADDR cellsWritten
; Write character codes 1 through 20:
    INVOKE WriteConsoleOutputCharacter,
        outHandle, ADDR buffer, BufSize,
        xyPos, ADDR cellsWritten
    INVOKE ExitProcess,0        ; end program
main ENDP
END main

```

Figure 11-3 shows a snapshot of the program's output, in which character codes 1 through 20 are displayed as graphic characters. Each character is in a different color, although the printed page appears in grayscale.

FIGURE 11-3 Output from the WriteColors program.



### 11.1.12 Time and Date Functions

The Win32 API provides a fairly large selection of time and date functions. Most commonly, you may want to use them to get and set the current date and time. We can only discuss a small subset of the functions here, but you can look up the Platform SDK documentation for the Win32 functions listed in Table 11-9.

Table 11-9 Win32 DateTime Functions.

| Function                        | Description                                                                                   |
|---------------------------------|-----------------------------------------------------------------------------------------------|
| CompareFileTime                 | Compares two 64-bit file times.                                                               |
| DosDateTimeToFileTime           | Converts MS-DOS date and time values to a 64-bit file time.                                   |
| FileTimeToDosDateTime           | Converts a 64-bit file time to MS-DOS date and time values.                                   |
| FileTimeToLocalFileTime         | Converts a UTC ( <i>universal coordinated time</i> ) file time to a local file time.          |
| FileTimeToSystemTime            | Converts a 64-bit file time to system time format.                                            |
| GetFileTime                     | Retrieves the date and time that a file was created, last accessed, and last modified.        |
| GetLocalTime                    | Retrieves the current local date and time.                                                    |
| GetSystemTime                   | Retrieves the current system date and time in UTC format.                                     |
| GetSystemTimeAdjustment         | Determines whether the system is applying periodic time adjustments to its time-of-day clock. |
| GetSystemTimeAsFileTime         | Retrieves the current system date and time in UTC format.                                     |
| GetTickCount                    | Retrieves the number of milliseconds that have elapsed since the system was started.          |
| GetTimeZoneInformation          | Retrieves the current time-zone parameters.                                                   |
| LocalFileTimeToFileTime         | Converts a local file time to a file time based on UTC.                                       |
| SetFileTime                     | Sets the date and time that a file was created, last accessed, or last modified.              |
| SetLocalTime                    | Sets the current local time and date.                                                         |
| SetSystemTime                   | Sets the current system time and date.                                                        |
| SetSystemTimeAdjustment         | Enables or disables periodic time adjustments to the system's time-of-day clock.              |
| SetTimeZoneInformation          | Sets the current time-zone parameters.                                                        |
| SystemTimeToFileTime            | Converts a system time to a file time.                                                        |
| SystemTimeToTzSpecificLocalTime | Converts a UTC time to a specified time zone's corresponding local time.                      |

**SYSTEMTIME Structure** The SYSTEMTIME structure is used by date- and time-related Windows API functions:

```
SYSTEMTIME STRUCT
    wYear WORD ?           ; year (4 digits)
    wMonth WORD ?         ; month (1-12)
```

```

wDayOfWeek WORD ?           ; day of week (0-6)
wDay WORD ?                 ; day (1-31)
wHour WORD ?                ; hours (0-23)
wMinute WORD ?             ; minutes (0-59)
wSecond WORD ?             ; seconds (0-59)
wMilliseconds WORD ?       ; milliseconds (0-999)
SYSTEMTIME ENDS

```

The *wDayOfWeek* field value begins with Sunday = 0, Monday = 1, and so on. The value in *wMilliseconds* is not exact because the system can periodically refresh the time by synchronizing with a time source.

### ***GetLocalTime and SetLocalTime***

The **GetLocalTime** function returns the date and current time of day, according to the system clock. The time is adjusted for the local time zone. When calling it, pass a pointer to a SYSTEMTIME structure:

```

GetLocalTime PROTO,
    lpSystemTime:PTR SYSTEMTIME

```

The following is a sample call to the GetLocalTime function:

```

.data
sysTime SYSTEMTIME <>
.code
INVOKE GetLocalTime, ADDR sysTime

```

The **SetLocalTime** function sets the system's local date and time. When calling it, pass a pointer to a SYSTEMTIME structure containing the desired date and time:

```

SetLocalTime PROTO,
    lpSystemTime:PTR SYSTEMTIME

```

If the function executes successfully, it returns a nonzero integer; if it fails, it returns zero.

### ***GetTickCount Function***

The **GetTickCount** function returns the number of milliseconds that have elapsed since the system was started:

```

GetTickCount PROTO           ; return value in EAX

```

Because the returned value is a doubleword, the time will wrap around to zero if the system is run continuously for 49.7 days. You can use this function to monitor the elapsed time in a loop and break out of the loop when a certain time limit has been reached.

The following *Timer.asm* program measures the elapsed time between two calls to GetTickCount. It attempts to verify that the timer count has not rolled over (beyond 49.7 days). Similar code could be used in a variety of programs:

```

; Calculate Elapsed Time (Timer.asm)
; Demonstrate a simple stopwatch timer, using
; the Win32 GetTickCount function.

```

```

INCLUDE Irvine32.inc
INCLUDE macros.inc

.data
startTime DWORD ?

.code
main PROC
    INVOKE GetTickCount          ; get starting tick count
    mov  startTime,eax          ; save it

    ; Create a useless calculation loop.
    mov  ecx,10000100h
L1:  imul ebx
     imul ebx
     imul ebx
     loop L1

    INVOKE GetTickCount          ; get new tick count
    cmp  eax,startTime          ; lower than starting one?
    jb   error                   ; it wrapped around

    sub  eax,startTime          ; get elapsed milliseconds
    call WriteDec                ; display it
    mWrite <" milliseconds have elapsed",0dh,0ah>
    jmp  quit

error:
    mWrite "Error: GetTickCount invalid--system has"
    mWrite <"been active for more than 49.7 days",0dh,0ah>
quit:
    exit
main ENDP
END main

```

### ***Sleep Function***

Programs sometimes need to pause or delay for short periods of time. Although one could construct a calculation loop or busy loop that keeps the processor busy, the loop's execution time would vary from one processor to the next. In addition, the busy loop would needlessly tie up the processor, slowing down other programs executing at the same time. The Win32 **Sleep** function suspends the currently executing thread for a specified number of milliseconds:

```

Sleep(
    dwMilliseconds:DWORD

```

(Because our assembly language programs are single-threaded, we will assume a thread is the same as a program.) A thread uses no processor time while it is sleeping.

### ***GetDate Time Procedure***

The **GetDate Time** procedure in the Irvine32 library returns the number of 100-nanosecond time intervals that have elapsed since January 1, 1601. This may seem a little odd, in that computers were unknown at the time. In any event, Microsoft uses this value to keep track of file dates and

times. The following steps are recommended by the Win32 SDK when you want to prepare a system date/time value for date arithmetic:

1. Call a function such as **GetLocalTime** that fills in a SYSTEMTIME structure.
2. Convert the SYSTEMTIME structure to a FILETIME structure by calling the **SystemTimeToFileTime** function.
3. Copy the resulting FILETIME structure to a 64-bit quadword.

A FILETIME structure divides a 64-bit quadword into two doublewords:

```
FILETIME STRUCT
    loDateTime DWORD ?
    hiDateTime DWORD ?
FILETIME ENDS
```

The following **GetDateTime** procedure receives a pointer to a 64-bit quadword variable. It stores the current date and time in the variable, in Win32 FILETIME format:

```
;-----
GetDateTime PROC,
    pStartTime:PTR QWORD
    LOCAL sysTime:SYSTEMTIME, flTime:FILETIME
;
; Gets and saves the current local date/time as a
; 64-bit integer (in the Win32 FILETIME format).
;-----
; Get the system local time
    INVOKE GetLocalTime,
        ADDR sysTime
; Convert the SYSTEMTIME to FILETIME
    INVOKE SystemTimeToFileTime,
        ADDR sysTime,
        ADDR flTime
; Copy the FILETIME to a 64-bit integer
    mov     esi,pStartTime
    mov     eax,flTime.loDateTime
    mov     DWORD PTR [esi],eax
    mov     eax,flTime.hiDateTime
    mov     DWORD PTR [esi+4],eax
    ret
GetDateTime ENDP
```

Because a SYSTEMTIME is a 64-bit integer, you can use the extended precision arithmetic techniques shown in Section 7.5 to perform date arithmetic.

### 11.1.13 Using the 64-Bit Windows API

You can rewrite any 32-bit calls to Windows API functions as calls to 64-bit functions. There are just a few key points to remember:

1. Input and output handles are 64 bits long.
2. Before calling a system function, the calling program must reserve at least 32 bytes of shadow space by subtracting 32 from the stack pointer (RSP) register. This allows the system function use the space to hold temporary copies of the RCX, RDX, R8, and R9 registers.
3. When calling a system function, RSP should be aligned on a 16-byte address boundary (basically, that's any hexadecimal address that ends with a zero). Fortunately, the Win64 API does not seem to enforce this rule, and it is often difficult to precisely control the stack alignment in application programs.
4. After a system call returns, the caller must restore RSP to its original value by adding the same value to it that was subtracted before the function call. This point is critical when you call a Win64 API function from a subroutine, because ESP must end up pointing at your subroutine's return address by the time you execute the RET instruction.
5. Integer parameters are passed in 64-bit registers.
6. INVOKE is not permitted. Instead, the first four arguments should be placed in the following registers, from left to right: RCX, RDX, R8, and R9. Additional arguments should be pushed on the runtime stack.
7. System functions return 64-bit integer values in RAX.

The following lines show how the 64-bit GetStdHandle function is called from the Irvine64 library:

```
.data
STD_OUTPUT_HANDLE EQU -11
consoleOutHandle QWORD ?
.code
sub rsp,40                ; reserve shadow space & align RSP
mov rcx,STD_OUTPUT_HANDLE
call GetStdHandle
mov consoleOutHandle,rax
add rsp,40
```

Once the console output handle has been initialized, the next code example shows how we call the 64-bit WriteConsoleA function. There are 5 arguments: RCX (the console handle), RDX (pointer to the string), R8 (length of the string), and R9 (a pointer to the bytesWritten variable), and a final dummy zero parameter, which is added to the 5th stack position above RSP.

```
WriteString proc uses rcx rdx r8 r9
    sub rsp, (5 * 8)        ; reserve space for 5 parameters
    movr cx,rdx
    call Str_length        ; returns length of string in EAX
    mov rcx,consoleOutHandle
    mov rdx,rdx            ; string pointer
    mov r8, rax            ; length of string
    lea r9,bytesWritten
    mov qword ptr [rsp + 4 * SIZEOF QWORD],0 ; (always zero)
    call WriteConsoleA
```

```

        add    rsp, (5 * 8)        ; restore RSP
        ret
WriteString ENDP

```

### 11.1.14 Section Review

1. What is the linker command that specifies that the target program is for the Win32 console?
2. (*True/False*): A function ending with the letter W (such as WriteConsoleW) is designed to work with a wide (16-bit) character set such as Unicode.
3. (*True/False*): Unicode is the native character set for Windows 98.
4. (*True/False*): The **ReadConsole** function reads mouse information from the input buffer.
5. (*True/False*): Win32 console input functions can detect when the user has resized the console window.

## 11.2 Writing a Graphical Windows Application

In this section, we will show how to write a simple graphical application for 32-bit Microsoft Windows. The program creates and displays a main window, displays message boxes, and responds to mouse events. The information provided here is only a brief introduction; it would require at least an entire chapter to describe the workings of even the simplest Windows application. If you want more information, see the Platform SDK documentation. Another great source is Charles Petzold's book, *Programming Windows*.

Table 11-10 lists the various libraries and includes files used when building this program. Use the Visual Studio project file located in the book's *Examples\Ch11\WinApp* folder to build and run the program.

TABLE 11-10 Files Required When Building the WinApp Program.

| Filename     | Description                                                                                |
|--------------|--------------------------------------------------------------------------------------------|
| WinApp.asm   | Program source code                                                                        |
| GraphWin.inc | Include file containing structures, constants, and function prototypes used by the program |
| kernel32.lib | Same MS-Windows API library used earlier in this chapter                                   |
| user32.lib   | Additional MS-Windows API functions                                                        |

`/SUBSYSTEM:WINDOWS` replaces the `/SUBSYSTEM:CONSOLE` we used in previous chapters. The program calls functions from two standard MS-Windows libraries: `kernel32.lib` and `user32.lib`.

**Main Window** The program displays a main window which fills the screen. It is reduced in size here to make it fit on the printed page (Fig. 11-4).

### 11.2.1 Necessary Structures

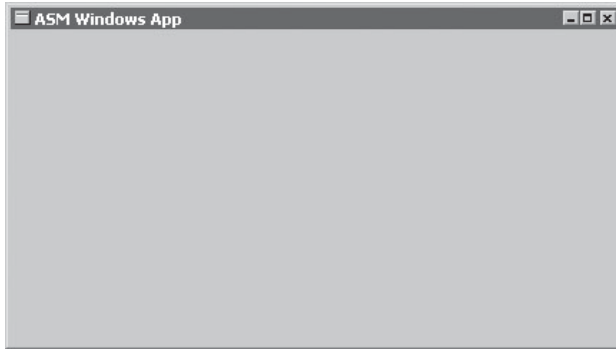
The **POINT** structure specifies the X and Y coordinates of a point on the screen, measured in pixels. It can be used, for example, to locate graphic objects, windows, and mouse clicks:

```

POINT STRUCT
    ptX  DWORD ?
    ptY  DWORD ?
POINT ENDS

```

FIGURE 11-4 Main startup window, WinApp program.



The **RECT** structure defines the boundaries of a rectangle. The **left** member contains the X-coordinate of the left side of the rectangle. The **top** member contains the Y-coordinate of the top of the rectangle. Similar values are stored in the **right** and **bottom** members:

```

RECT STRUCT
    left      DWORD ?
    top       DWORD ?
    right     DWORD ?
    bottom    DWORD ?
RECT ENDS

```

The **MSGStruct** structure defines the data needed for an MS-Windows message:

```

MSGStruct STRUCT
    msgWnd      DWORD ?
    msgMessage  DWORD ?
    msgWparam   DWORD ?
    msgLparam   DWORD ?
    msgTime     DWORD ?
    msgPt       POINT <>
MSGStruct ENDS

```

The **WNDCLASS** structure defines a window class. Each window in a program must belong to a class, and each program must define a window class for its main window. This class is registered with the operating system before the main window can be shown:

```

WNDCLASS STRUC
    style          DWORD ?           ; window style options
    lpfnWndProc    DWORD ?           ; pointer to WinProc function
    cbClsExtra     DWORD ?           ; shared memory
    cbWndExtra     DWORD ?           ; number of extra bytes
    hInstance      DWORD ?           ; handle to current program
    hIcon          DWORD ?           ; handle to icon

```



```

    hCursor          DWORD ?           ; handle to cursor
    hbrBackground    DWORD ?           ; handle to background brush
    lpzMenuName      DWORD ?           ; pointer to menu name
    lpzClassName     DWORD ?           ; pointer to WinClass name
WNDCLASS ENDS

```

Here's a quick summary of the parameters:

- *style* is a conglomerate of different style options, such as `WS_CAPTION` and `WS_BORDER`, that control the window's appearance and behavior.
- *lpfnWndProc* is a pointer to a function (in our program) that receives and processes event messages triggered by the user.
- *cbClsExtra* refers to shared memory used by all windows belonging to the class. Can be null.
- *cbWndExtra* specifies the number of extra bytes to allocate following the window instance.
- *hInstance* holds a handle to the current program instance.
- *hIcon* and *hCursor* hold handles to icon and cursor resources for the current program.
- *hbrBackground* holds a handle to a background (color) brush.
- *lpzMenuName* points to a menu name.
- *lpzClassName* points to a null-terminated string containing the window's class name.

### 11.2.2 The MessageBox Function

The easiest way for a program to display text is to put it in a message box that pops up and waits for the user to click on a button. The **MessageBox** function from the Win32 API library displays a simple message box. Its prototype is shown here:

```

MessageBox PROTO,
    hWnd:DWORD,
    lpText:PTR BYTE,
    lpCaption:PTR BYTE,
    uType:DWORD

```

*hWnd* is a handle to the current window. *lpText* points to a null-terminated string that will appear inside the box. *lpCaption* points to a null-terminated string that will appear in the box's caption bar. *style* is an integer that describes both the dialog box's icon (optional) and the buttons (required). Buttons are identified by constants such as `MB_OK` and `MB_YESNO`. Icons are also identified by constants such as `MB_ICONQUESTION`. When a message box is displayed, you can add together the constants for the icon and buttons:

```

INVOKE MessageBox, hWnd, ADDR QuestionText,
    ADDR QuestionTitle, MB_OK + MB_ICONQUESTION

```

### 11.2.3 The WinMain Procedure

Every Windows application needs a startup procedure, usually named **WinMain**, which is responsible for the following tasks:

- Get a handle to the current program.
- Load the program's icon and mouse cursor.
- Register the program's main window class and identify the procedure that will process event messages for the window.
- Create the main window.

- Show and update the main window.
- Begin a loop that receives and dispatches messages. The loop continues until the user closes the application window.

WinMain contains a message processing loop that calls **GetMessage** to retrieve the next available message from the program's message queue. If GetMessage retrieves a WM\_QUIT message, it returns zero, telling WinMain that it's time to halt the program. For all other messages, WinMain passes them to the **DispatchMessage** function, which forwards them to the program's WinProc procedure. To read more about messages, search for *Windows Messages* in the Platform SDK documentation.

### 11.2.4 The WinProc Procedure

The **WinProc** procedure receives and processes all event messages relating to a window. Most events are initiated by the user by clicking and dragging the mouse, pressing keyboard keys, and so on. This procedure's job is to decode each message, and if the message is recognized, to carry out application-oriented tasks relating to the message. Here is the declaration:

```
WinProc PROC,
    hWnd:DWORD,           ; handle to the window
    lParam:DWORD,        ; message ID
    wParam:DWORD,        ; parameter 1 (varies)
    lParam:DWORD         ; parameter 2 (varies)
```

The content of the third and fourth parameters will vary, depending on the specific message ID. When the mouse is clicked, for example, *lParam* contains the X- and Y-coordinates of the point clicked. In the upcoming example program, the **WinProc** procedure handles three specific messages:

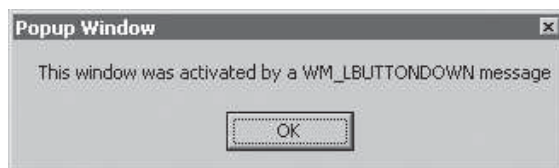
- WM\_LBUTTONDOWN, generated when the user presses the left mouse button
- WM\_CREATE, indicates that the main window was just created
- WM\_CLOSE, indicates that the application's main window is about to close

For example, the following lines (from the procedure) handle the WM\_LBUTTONDOWN message by calling **MessageBox** to display a popup message to the user:

```
.IF eax == WM_LBUTTONDOWN
    INVOKE MessageBox, hWnd, ADDR PopupText,
        ADDR PopupTitle, MB_OK
    jmp WinProcExit
```

The resulting message seen by the user is shown in Fig. 11-5. Any other messages that we don't wish to handle are passed on to **DefWindowProc**, the default message handler for MS-Windows.

FIGURE 11-5 Popup window, WinApp program.



### 11.2.5 The ErrorHandler Procedure

The **ErrorHandler** procedure, which is optional, is called if the system reports an error during the registration and creation of the program's main window. For example, the **RegisterClass** function returns a nonzero value if the program's main window was successfully registered. But if it returns zero, we call **ErrorHandler** (to display a message) and quit the program:

```

        INVOKE RegisterClass, ADDR MainWin
        .IF eax == 0
            call ErrorHandler
            jmp Exit_Program
        .ENDIF

```

The **ErrorHandler** procedure has several important tasks to perform:

- Call **GetLastError** to retrieve the system error number.
- Call **FormatMessage** to retrieve the appropriate system-formatted error message string.
- Call **MessageBox** to display a popup message box containing the error message string.
- Call **LocalFree** to free the memory used by the error message string.

### 11.2.6 Program Listing

Don't be distressed by the length of this program. Much of it is code that would be identical in any MS-Windows application:

```

; Windows Application                (WinApp.asm)
; This program displays a resizable application window and
; several popup message boxes. Special thanks to Tom Joyce
; for the first version of this program.

.386
.model flat,STDCALL
INCLUDE GraphWin.inc

;===== DATA =====
.data
AppLoadMsgTitle BYTE "Application Loaded",0
AppLoadMsgText  BYTE "This window displays when the WM_CREATE "
                BYTE "message is received",0

PopupTitle     BYTE "Popup Window",0
PopupText      BYTE "This window was activated by a "
                BYTE "WM_LBUTTONDOWN message",0

GreetTitle     BYTE "Main Window Active",0
GreetText      BYTE "This window is shown immediately after "
                BYTE "CreateWindow and UpdateWindow are called.",0

CloseMsg       BYTE "WM_CLOSE message received",0

ErrorTitle     BYTE "Error",0
WindowName     BYTE "ASM Windows App",0
className      BYTE "ASMWin",0

```

```

; Define the Application's Window class structure.
MainWin WNDCLASS <NULL,WinProc,NULL,NULL,NULL,NULL,NULL, \
    COLOR_WINDOW,NULL,className>

msg          MSGStruct <>
winRect      RECT <>
hMainWnd     DWORD ?
hInstance    DWORD ?

;===== CODE =====
.code
WinMain PROC

; Get a handle to the current process.
    INVOKE GetModuleHandle, NULL
    mov     hInstance, eax
    mov     MainWin.hInstance, eax

; Load the program's icon and cursor.
    INVOKE LoadIcon, NULL, IDI_APPLICATION
    mov     MainWin.hIcon, eax
    INVOKE LoadCursor, NULL, IDC_ARROW
    mov     MainWin.hCursor, eax

; Register the window class.
    INVOKE RegisterClass, ADDR MainWin
    .IF eax == 0
        call ErrorHandler
        jmp Exit_Program
    .ENDIF

; Create the application's main window.
    INVOKE CreateWindowEx, 0, ADDR className,
        ADDR WindowName,MAIN_WINDOW_STYLE,
        CW_USEDEFAULT,CW_USEDEFAULT,CW_USEDEFAULT,
        CW_USEDEFAULT,NULL,NULL,hInstance,NULL

; If CreateWindowEx failed, display a message and exit.
    .IF eax == 0
        call ErrorHandler
        jmp Exit_Program
    .ENDIF

; Save the window handle, show and draw the window.
    mov hMainWnd,eax
    INVOKE ShowWindow, hMainWnd, SW_SHOW
    INVOKE UpdateWindow, hMainWnd

; Display a greeting message.
    INVOKE MessageBox, hMainWnd, ADDR GreetText,
        ADDR GreetTitle, MB_OK

; Begin the program's continuous message-handling loop.
Message_Loop:
    ; Get next message from the queue.
    INVOKE GetMessage, ADDR msg, NULL,NULL,NULL

```

```

; Quit if no more messages.
.IF eax == 0
    jmp Exit_Program
.ENDIF

; Relay the message to the program's WinProc.
INVOKE DispatchMessage, ADDR msg
jmp Message_Loop

Exit_Program:
    INVOKE ExitProcess,0
WinMain ENDP

```

In the previous loop, the **msg** structure is passed to the **GetMessage** function. It fills in the structure, which is then passed to the MS-Windows **DispatchMessage** function.

```

;-----
WinProc PROC,
    hWnd:DWORD, localMsg:DWORD, wParam:DWORD, lParam:DWORD
;
; The application's message handler, which handles
; application-specific messages. All other messages
; are forwarded to the default Windows message
; handler.
;-----
    mov eax, localMsg

    .IF eax == WM_LBUTTONDOWN          ; mouse button?
        INVOKE MessageBox, hWnd, ADDR PopupText,
            ADDR PopupTitle, MB_OK
        jmp WinProcExit
    .ELSEIF eax == WM_CREATE           ; create window?
        INVOKE MessageBox, hWnd, ADDR AppLoadMsgText,
            ADDR AppLoadMsgTitle, MB_OK
        jmp WinProcExit
    .ELSEIF eax == WM_CLOSE           ; close window?
        INVOKE MessageBox, hWnd, ADDR CloseMsg,
            ADDR WindowName, MB_OK
        INVOKE PostQuitMessage,0
        jmp WinProcExit
    .ELSE                             ; other message?
        INVOKE DefWindowProc, hWnd, localMsg, wParam, lParam
        jmp WinProcExit
    .ENDIF

WinProcExit:
    ret
WinProc ENDP

;-----
ErrorHandler PROC
; Display the appropriate system error message.
;-----

```

```

.data
pErrorMsg  DWORD ?           ; ptr to error message
messageID  DWORD ?
.code
    INVOKE GetLastError      ; Returns message ID in EAX
    mov     messageID,eax

    ; Get the corresponding message string.
    INVOKE FormatMessage, FORMAT_MESSAGE_ALLOCATE_BUFFER + \
        FORMAT_MESSAGE_FROM_SYSTEM,NULL,messageID,NULL,
        ADDR pErrorMsg,NULL,NULL

    ; Display the error message.
    INVOKE MessageBox,NULL, pErrorMsg, ADDR ErrorTitle,
        MB_ICONERROR+MB_OK

    ; Free the error message string.
    INVOKE LocalFree, pErrorMsg
    ret
ErrorHandler ENDP
END WinMain

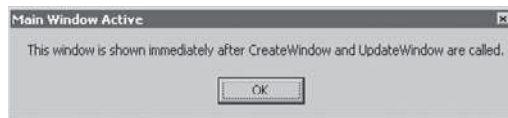
```

### Running the Program

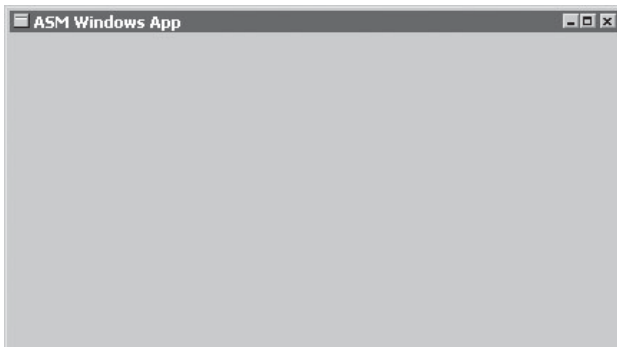
When the program first loads, the following message box displays:



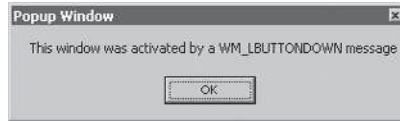
When the user clicks on OK to close the **Application Loaded** message box, another message box displays:



When the user closes the **Main Window Active** message box, the program's main window displays:



When the user clicks the mouse anywhere inside the main window, the following message box displays:



When the user closes this message box and then clicks on the X in the upper-right corner of the main window, the following message displays just before the window closes:



When the user closes this message box, the program ends.

### 11.2.7 Section Review

1. Describe a **POINT** structure.
2. How is the **WNDCLASS** structure used?
3. In a **WNDCLASS** structure, what is the meaning of the *lpfnWndProc* field?
4. In a **WNDCLASS** structure, what is the meaning of the *style* field?
5. In a **WNDCLASS** structure, what is the meaning of the *hInstance* field?

## 11.3 Dynamic Memory Allocation

*Dynamic memory allocation*, also known as *heap allocation*, is a technique programming languages use for reserving memory when objects, arrays, and other structures are created. In Java, for example, a statement such as the following causes memory to be reserved for a String object:

```
String str = new String("abcde");
```

Similarly, in C++ you might want to allocate space for an array of integers, using a size attribute from a variable:

```
int size;
cin >> size;                // user inputs the size
int array[] = new int[size];
```

C, C++, and Java have built-in runtime heap managers that handle programmatic requests for storage allocation and deallocation. Heap managers generally allocate a large block of memory from the operating system when the program starts up. They create a *free list* of pointers to storage blocks. When an allocation request is received, the heap manager marks an appropriately sized block of memory as reserved and returns a pointer to the block. Later, when a delete request for the same block is received, the heap frees up the block, returning it to the free list. Each time a new allocation request is received, the heap manager scans the free list, looking for the first available block large enough to grant the request.

Assembly language programs can perform dynamic allocation in a couple of ways. First, they can make system calls to get blocks of memory from the operating system. Second, they can implement their own heap managers that serve requests for smaller objects. In this section, we show how to implement the first method. The example program is a 32-bit protected mode application.

You can request multiple blocks of memory of varying sizes from Windows, using several Win32 API functions listed in Table 11-11. All of these functions overwrite the general-purpose registers, so you may want to create wrapper procedures that push and pop important registers. To learn more about memory management, search for *Memory Management Reference* in the Microsoft online documentation.

Table 11-11 Heap-Related Functions.

| Function       | Description                                                                                                                                                                                                                                                                                                              |
|----------------|--------------------------------------------------------------------------------------------------------------------------------------------------------------------------------------------------------------------------------------------------------------------------------------------------------------------------|
| GetProcessHeap | Returns a 32-bit integer handle to the program's existing heap area in EAX. If the function succeeds, it returns a handle to the heap in EAX. If it fails, the return value in EAX is NULL.                                                                                                                              |
| HeapAlloc      | Allocates a block of memory from a heap. If it succeeds, the return value in EAX contains the address of the memory block. If it fails, the returned value in EAX is NULL.                                                                                                                                               |
| HeapCreate     | Creates a new heap and makes it available to the calling program. If the function succeeds, it returns a handle to the newly created heap in EAX. If it fails, the return value in EAX is NULL.                                                                                                                          |
| HeapDestroy    | Destroys the specified heap object and invalidates its handle. If the function succeeds, the return value in EAX is nonzero.                                                                                                                                                                                             |
| HeapFree       | Frees a block of memory previously allocated from a heap, identified by its address and heap handle. If the block is freed successfully, the return value is nonzero.                                                                                                                                                    |
| HeapReAlloc    | Reallocates and resizes a block of memory from a heap. If the function succeeds, the return value is a pointer to the reallocated memory block. If the function fails and you have not specified HEAP_GENERATE_EXCEPTIONS, the return value is NULL.                                                                     |
| HeapSize       | Returns the size of a memory block previously allocated by a call to HeapAlloc or HeapReAlloc. If the function succeeds, EAX contains the size of the allocated memory block, in bytes. If the function fails, the return value is SIZE_T - 1. (SIZE_T equals the maximum number of bytes to which a pointer can point.) |

**GetProcessHeap** GetProcessHeap is sufficient if you're content to use the default heap owned by the current program. It has no parameters, and the return value in EAX is the heap handle:

```
GetProcessHeap PROTO
```

Sample call:

```
.data
hHeap HANDLE ?
.code
INVOKE GetProcessHeap
.IF eax == NULL                ; cannot get handle
    jmp quit
```



```

.ELSE
    mov     hHeap,eax                ; handle is OK
.ENDIF

```

**HeapCreate** HeapCreate lets you create a new private heap for the current program:

```

HeapCreate PROTO,
    flOptions:DWORD,                ; heap allocation options
    dwInitialSize:DWORD,           ; initial heap size, in bytes
    dwMaximumSize:DWORD           ; maximum heap size, in bytes

```

Set *flOptions* to NULL. Set *dwInitialSize* to the initial heap size, in bytes. The value is rounded up to the next page boundary. When calls to HeapAlloc exceed the initial heap size, it will grow as large as the value you specify in the *dwMaximumSize* parameter (rounded up to the next page boundary). After calling it, a null return value in EAX indicates the heap was not created. The following is a sample call to HeapCreate:

```

HEAP_START = 2000000                ; 2 MB
HEAP_MAX   = 400000000             ; 400 MB
.data
hHeap HANDLE ?                    ; handle to heap
.code
INVOKE HeapCreate, 0, HEAP_START, HEAP_MAX
.IF eax == NULL                    ; heap not created
    call WriteWindowsMsg           ; show error message
    jmp  quit
.ELSE
    mov     hHeap,eax                ; handle is OK
.ENDIF

```

**HeapDestroy** HeapDestroy destroys an existing private heap (one created by HeapCreate). Pass it a handle to the heap:

```

HeapDestroy PROTO,
    hHeap:DWORD                    ; heap handle

```

If it fails to destroy the heap, EAX equals NULL. Following is a sample call, using the WriteWindowsMsg procedure described in Section 11.1.4:

```

.data
hHeap HANDLE ?                    ; handle to heap
.code
INVOKE HeapDestroy, hHeap
.IF eax == NULL
    call WriteWindowsMsg           ; show error message
.ENDIF

```

**HeapAlloc** HeapAlloc allocates a memory block from an existing heap:

```

HeapAlloc PROTO,
    hHeap:HANDLE,                  ; handle to existing heap block
    dwFlags:DWORD,                ; heap allocation control flags
    dwBytes:DWORD                  ; number of bytes to allocate

```

Pass the following arguments:

- *hHeap*, a 32-bit handle to a heap that was initialized by `GetProcessHeap` or `HeapCreate`.
- *dwFlags*, a doubleword containing one or more flag values. You can optionally set it to `HEAP_ZERO_MEMORY`, which sets the memory block to all zeros.
- *dwBytes*, a doubleword indicating the size of the heap allocation, in bytes.

If `HeapAlloc` succeeds, `EAX` contains a pointer to the new storage; if it fails, the value returned in `EAX` is `NULL`. The following code allocates a 1000-byte array from the heap identified by **hHeap** and initializes the array to all zeros:

```
.data
hHeap HANDLE ?           ; heap handle
pArray DWORD ?         ; pointer to array
.code
INVOKE HeapAlloc, hHeap, HEAP_ZERO_MEMORY, 1000
.IF eax == NULL
    mWrite "HeapAlloc failed"
    jmp quit
.ELSE
    mov pArray, eax
.ENDIF
```

**HeapFree** The `HeapFree` function frees a block of memory previously allocated from a heap, identified by its address and heap handle:

```
HeapFree PROTO,
    hHeap:HANDLE,
    dwFlags:DWORD,
    lpMem:DWORD
```

The first argument is a handle to the heap containing the memory block. The second argument is usually zero, and the third argument is a pointer to the block of memory to be freed. If the block is freed successfully, the return value is nonzero. If the block cannot be freed, the function returns zero. Here is a sample call:

```
INVOKE HeapFree, hHeap, 0, pArray
```

**Error Handling** If you encounter an error when calling `HeapCreate`, `HeapDestroy`, or `GetProcessHeap`, you can get details by calling the **GetLastError** API function. Or, you can call the **WriteWindowsMsg** function from the `Irvine32` library. Following is an example that calls `HeapCreate`:

```
INVOKE HeapCreate, 0, HEAP_START, HEAP_MAX
.IF eax == NULL           ; failed?
    call WriteWindowsMsg ; show error message
.ELSE
    mov hHeap, eax       ; success
.ENDIF
```

The **HeapAlloc** function, on the other hand, does not set a system error code when it fails, so you cannot call `GetLastError` or `WriteWindowsMsg`.

### 11.3.1 HeapTest Programs

The following example (*Heaptest1.asm*) uses dynamic memory allocation to create and fill a 1000-byte array:

```

; Heap Test #1                                     (Heaptest1.asm)
INCLUDE Irvine32.inc

; This program uses dynamic memory allocation to allocate and
; fill an array of bytes.

.data
ARRAY_SIZE = 1000
FILL_VAL EQU 0FFh

hHeap HANDLE ? ; handle to the process heap
pArray DWORD ? ; pointer to block of memory
newHeap DWORD ? ; handle to new heap
str1 BYTE "Heap size is: ",0

.code
main PROC
    INVOKE GetProcessHeap ; get handle prog's heap
    .IF eax == NULL ; if failed, display message
    call WriteWindowsMsg
    jmp quit
    .ELSE
    mov hHeap,eax ; success
    .ENDIF

    call allocate_array
    jnc arrayOk ; failed (CF = 1)?
    call WriteWindowsMsg
    call Crlf
    jmp quit

arrayOk: ; ok to fill the array
    call fill_array
    call display_array
    call Crlf

    ; free the array
    INVOKE HeapFree, hHeap, 0, pArray

quit:
    exit
main ENDP

;-----
allocate_array PROC USES eax
;
; Dynamically allocates space for the array.
; Receives: EAX = handle to the program heap
; Returns: CF = 0 if the memory allocation succeeds.
;-----
    INVOKE HeapAlloc, hHeap, HEAP_ZERO_MEMORY, ARRAY_SIZE

```

```

        .IF eax == NULL
            stc                ; return with CF = 1
        .ELSE
            mov  pArray,eax    ; save the pointer
            clc                ; return with CF = 0
        .ENDIF

        ret
allocate_array ENDP

;-----
fill_array PROC USES ecx edx esi
;
; Fills all array positions with a single character.
; Receives: nothing
; Returns: nothing
;-----
        mov  ecx,ARRAY_SIZE    ; loop counter
        mov  esi,pArray        ; point to the array
L1: mov  BYTE PTR [esi],FILL_VAL ; fill each byte
    inc  esi                    ; next location
    loop L1

        ret
fill_array ENDP

;-----
display_array PROC USES eax ebx ecx esi
;
; Displays the array
; Receives: nothing
; Returns: nothing
;-----
        mov  ecx,ARRAY_SIZE    ; loop counter
        mov  esi,pArray        ; point to the array
L1: mov  al,[esi]              ; get a byte
    mov  ebx,TYPE BYTE
    call WriteHexB            ; display it
    inc  esi                    ; next location
    loop L1

        ret
display_array ENDP

END main

```

The following example (*Heaptest2.asm*) uses dynamic memory allocation to repeatedly allocate large blocks of memory until the heap size is exceeded.

```

; Heap Test #2                (Heaptest2.asm)
INCLUDE Irvine32.inc

.data
HEAP_START = 2000000          ; 2 MByte

```

```

HEAP_MAX = 400000000      ; 400 MByte
BLOCK_SIZE = 500000      ; .5 MByte

hHeap HANDLE ?           ; handle to the heap
pData DWORD ?           ; pointer to block

str1 BYTE 0dh,0ah,"Memory allocation failed",0dh,0ah,0

.code
main PROC
    INVOKE HeapCreate, 0,HEAP_START, HEAP_MAX
    .IF eax == NULL      ; failed?
    call WriteWindowsMsg
    call Crlf
    jmp quit
    .ELSE
    mov hHeap,eax        ; success
    .ENDIF

    mov ecx,2000         ; loop counter
L1: call allocate_block  ; allocate a block
    .IF Carry?          ; failed?
    mov edx,OFFSET str1 ; display message
    call WriteString
    jmp quit
    .ELSE                ; no: print a dot to
    mov al, '.'          ; show progress
    call WriteChar
    .ENDIF

    ;call free_block    ; enable/disable this line
    loop L1

quit:
    INVOKE HeapDestroy, hHeap ; destroy the heap
    .IF eax == NULL        ; failed?
    call WriteWindowsMsg   ; yes: error message
    call Crlf
    .ENDIF

    exit
main ENDP

allocate_block PROC USES ecx
    ; allocate a block and fill with all zeros.
    INVOKE HeapAlloc, hHeap, HEAP_ZERO_MEMORY, BLOCK_SIZE

    .IF eax == NULL
    stc                    ; return with CF = 1
    .ELSE
    mov pData,eax         ; save the pointer
    clc                    ; return with CF = 0
    .ENDIF

```

```

        ret
allocate_block ENDP

free_block PROC USES ecx
        INVOKE HeapFree, hHeap, 0, pData
        ret
free_block ENDP
END main

```

### 11.3.2 Section Review

1. What is another term for *heap allocation*, in the context of C, C++, and Java?
2. Describe the `GetProcessHeap` function.
3. Describe the `HeapAlloc` function.
4. Show a sample call to the `HeapCreate` function.
5. When calling `HeapDestroy`, how do you identify the memory block being destroyed?

## 11.4 x86 Memory Management

In this section, we would like to give a brief overview of Windows 32-bit memory management, showing how it uses capabilities built directly into x86 processors. We will focus on two primary aspects of memory management:

- Translating logical addresses into linear addresses
- Translating linear addresses into physical addresses (paging)

Let's briefly review some of the x86 memory-management terms introduced in Chapter 2, beginning with the following:

- *Multitasking* permits multiple programs (or tasks) to run at the same time. The processor divides its time among all of the running programs.
- *Segments* are variable-sized areas of memory used by a program containing either code or data.
- *Segmentation* provides a way to isolate memory segments from each other. This permits multiple programs to run simultaneously without interfering with each other.
- A *segment descriptor* is a 64-bit value that identifies and describes a single memory segment: It contains information about the segment's base address, access rights, size limit, type, and usage.

Now we will add two new terms to the list:

- A *segment selector* is a 16-bit value stored in a segment register (CS, DS, SS, ES, FS, or GS).
- A *logical address* is a combination of a segment selector and a 32-bit offset.

Segment registers have been ignored throughout this book because they are never modified directly by user programs. We have only been concerned with 32-bit data offsets. From a system

programmer's point of view, however, segment registers are important because they contain indirect references to memory segments.

### 11.4.1 Linear Addresses

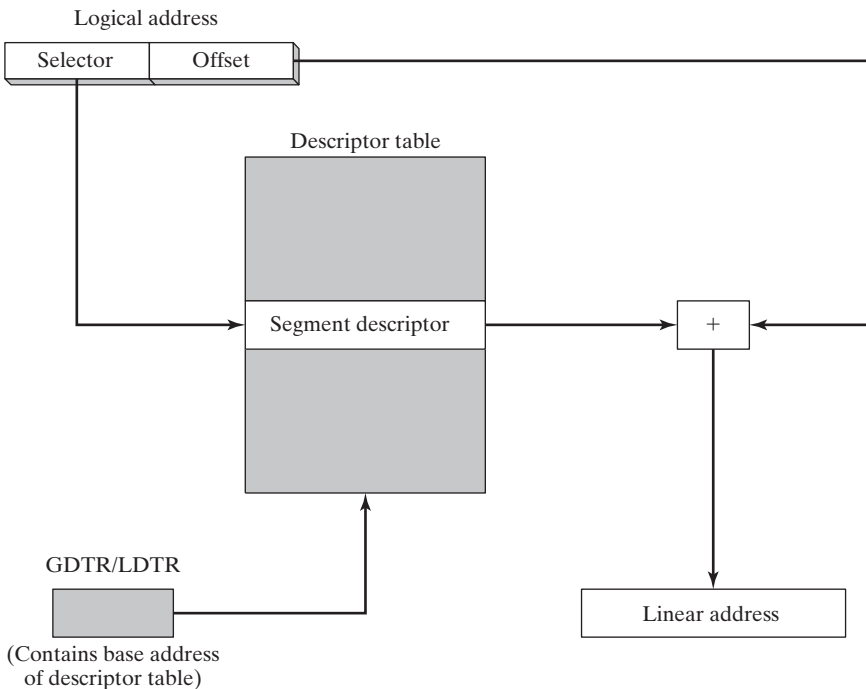
#### ***Translating Logical Addresses to Linear Addresses***

A multitasking operating system allows several programs (tasks) to run in memory at the same time. Each program has its own unique area for data. Suppose three programs each had a variable at offset 200h; how could the three variables be separate from each other without being shared? The answer to this is that x86 processors use a one- or two-step process to convert each variable's offset into a unique memory location.

The first step combines a segment value with a variable's offset to create a *linear address*. This linear address could be the variable's physical address. But operating systems such as MS-Windows and Linux employ a feature called *paging* to permit programs to use more linear memory than is physically available in the computer. They must use a second step called *page translation* to convert a linear address to a physical address. We will explain page translation in Section 11.4.2.

First, let's look at the way the processor uses a segment and offset to determine the linear address of a variable. Each segment selector points to a segment descriptor (in a descriptor table), which contains the base address of a memory segment. The 32-bit offset from the logical address is added to the segment's base address, generating a 32-bit *linear address*, as shown in Fig. 11-6.

FIGURE 11-6 Converting a logical address into a linear address.



**Linear Address** A *linear address* is a 32-bit integer ranging between 0 and FFFFFFFFh, which refers to a memory location. The linear address may also be the physical address of the target data if a feature called *paging* is disabled.

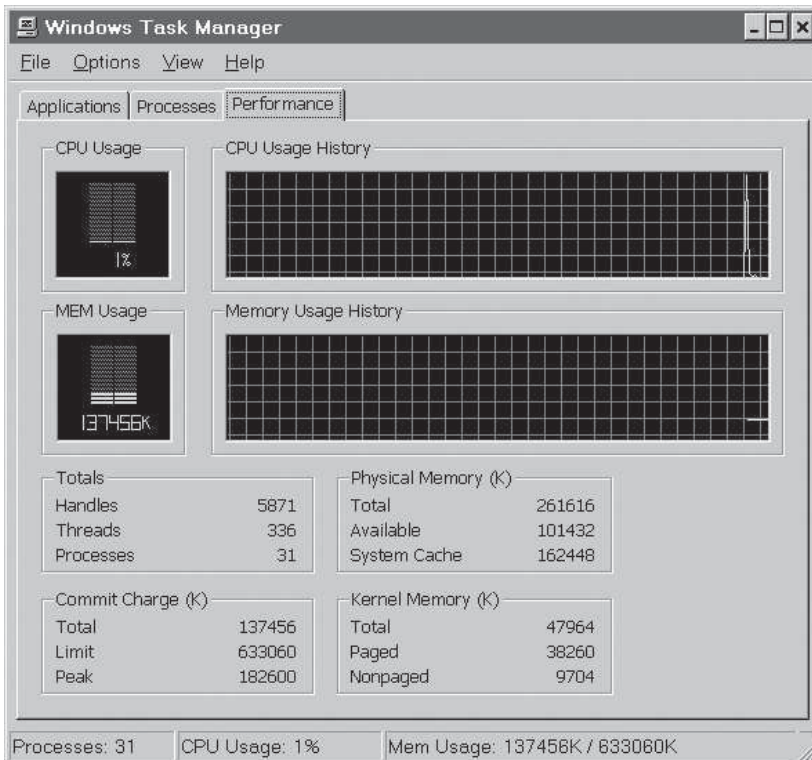
### Paging

*Paging* is an important feature of the x86 processor that makes it possible for a computer to run a combination of programs that would not otherwise fit into memory. The processor does this by initially loading only part of a program in memory while keeping the remaining parts on disk. The memory used by the program is divided into small units called *pages*, typically 4 KByte each. As each program runs, the processor selectively unloads inactive pages from memory and loads other pages that are immediately required.

The operating system maintains a *page directory* and a set of *page tables* to keep track of the pages used by all programs currently in memory. When a program attempts to access an address somewhere in the linear address space, the processor automatically converts the linear address into a physical address. This conversion is called *page translation*. If the requested page is not currently in memory, the processor interrupts the program and issues a *page fault*. The operating system copies the required page from disk into memory before the program can resume. From the point of view of an application program, page faults and page translation happen automatically.

You can activate a Microsoft Windows utility named *Task Manager* and see the difference between physical memory and virtual memory. Figure 11-7 shows a computer with 256 MByte

FIGURE 11-7 Windows Task Manager example.





of physical memory. The total amount of virtual memory currently in use is in the *Commit Charge* frame of the Task Manager. The virtual memory limit is 633 MByte, considerably larger than the computer's physical memory size.

**Descriptor Tables**

Segment descriptors can be found in two types of tables: *global descriptor tables* and *local descriptor tables*.

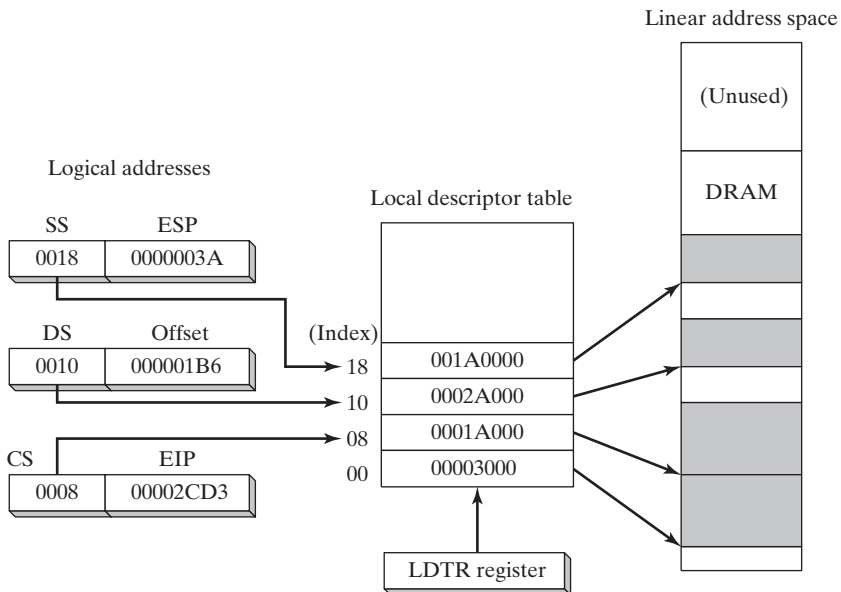
**Global Descriptor Table (GDT)** A single GDT is created when the operating system switches the processor into protected mode during boot up. Its base address is held in the GDTR (global descriptor table register). The table contains entries (called *segment descriptors*) that point to segments. The operating system has the option of storing the segments used by all programs in the GDT.

**Local Descriptor Tables (LDT)** In a multitasking operating system, each task or program is usually assigned its own table of segment descriptors, called an LDT. The LDTR register contains the address of the program's LDT. Each segment descriptor contains the base address of a segment within the linear address space. This segment is usually distinct from all other segments, as in Fig. 11-8. Three different logical addresses are shown, each selecting a different entry in the LDT. In this figure we assume that paging is disabled, so the linear address space is also the physical address space.

**Segment Descriptor Details**

In addition to the segment's base address, the segment descriptor contains bit-mapped fields specifying the segment limit and segment type. An example of a read-only segment type is the code segment. If a program tries to modify a read-only segment, a processor fault is generated.

FIGURE 11-8 Indexing into a local descriptor table.



Segment descriptors can contain protection levels that protect operating system data from access by application programs. The following are descriptions of individual selector fields:

**Base address:** A 32-bit integer that defines the starting location of the segment in the 4 GByte linear address space.

**Privilege level:** Each segment can be assigned a privilege level between 0 and 3, where 0 is the most privileged, usually for operating system kernel code. If a program with a higher-numbered privilege level tries to access a segment having a lower-numbered privilege level, a processor fault is generated.

**Segment type:** Indicates the type of segment and specifies the type of access that can be made to the segment and the direction the segment can grow (up or down). Data (including Stack) segments can be read-only or read/write and can grow either up or down. Code segments can be execute-only or execute/read-only.

**Segment present flag:** This bit indicates whether the segment is currently present in physical memory.

**Granularity flag:** Determines the interpretation of the Segment limit field. If the bit is clear, the segment limit is interpreted in byte units. If the bit is set, the segment limit is interpreted in 4096-byte units.

**Segment limit:** This 20-bit integer specifies the size of the segment. It is interpreted in one of the following two ways, depending on the Granularity flag:

- The number of bytes in the segment, ranging from 1 to 1 MByte.
- The number of 4096-byte units, permitting the segment size to range from 4 KByte to 4 GByte.

### 11.4.2 Page Translation

When paging is enabled, the processor must translate a 32-bit linear address into a 32-bit physical address.<sup>2</sup> There are three structures used in the process:

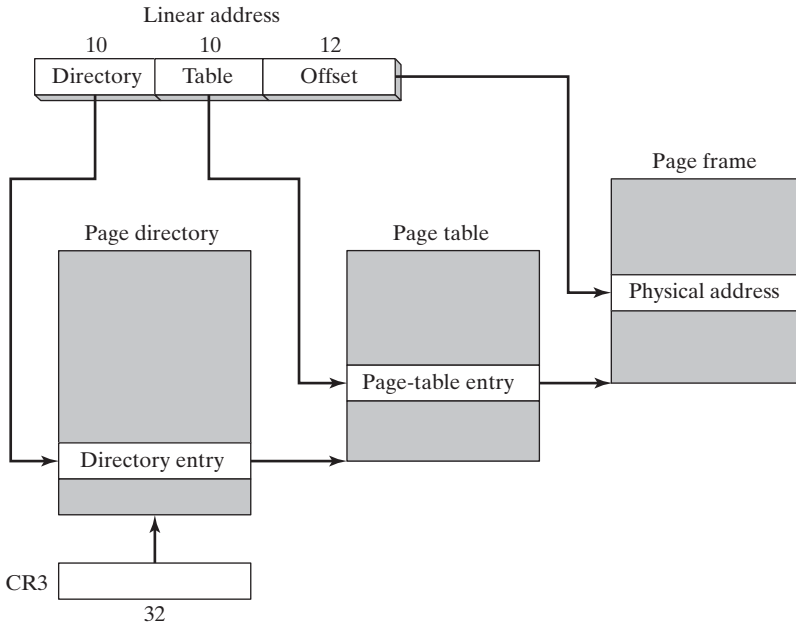
- Page directory: An array of up to 1024 32-bit page-directory entries.
- Page table: An array of up to 1024 32-bit page-table entries.
- Page: A 4 KByte or 4 MByte address space.

To simplify the following discussion, we will assume that 4 KByte pages are used:

A linear address is divided into three fields: a pointer to a page-directory entry, a pointer to a page-table entry, and an offset into a page frame. Control register (CR3) contains the starting address of the page directory. The following steps are carried out by the processor when translating a linear address to a physical address, as shown in Fig. 11-9:

1. The *linear address* references a location in the linear address space.
2. The 10-bit *directory* field in the linear address is an index to a page-directory entry. The page-directory entry contains the base address of a page table.
3. The 10-bit *table* field in the linear address is an index into the page table identified by the page-directory entry. The page-table entry at that position contains the base location of a *page* in physical memory.
4. The 12-bit *offset* field in the linear address is added to the base address of the page, generating the exact physical address of the operand.

FIGURE 11-9 Translating linear address to physical address.



The operating system has the option of using a single page directory for all running programs and tasks, or one page directory per task, or a combination of the two.

### **Windows Virtual Machine Manager**

Now that we have a general idea of how the IA-32 manages memory, it might be interesting to see how memory management is handled by Windows. The following passage is paraphrased from the online Microsoft documentation:

The Virtual Machine Manager (VMM) is the 32-bit protected mode operating system at the core of Windows. It creates, runs, monitors, and terminates virtual machines. It manages memory, processes, interrupts, and exceptions. It works with *virtual devices*, allowing them to intercept interrupts and faults that control access to hardware and installed software. The VMM and virtual devices run in a single 32-bit flat model address space at privilege level 0. The system creates two global descriptor table entries (segment descriptors), one for code and the other for data. The segments are fixed at linear address 0. The VMM provides multithreaded, preemptive multitasking. It runs multiple applications simultaneously by sharing CPU time between the virtual machines in which the applications run.

In the foregoing passage, we can interpret the term *virtual machine* to be what Intel calls a *process* or *task*. It consists of program code, supporting software, memory, and registers. Each virtual machine is assigned its own address space, I/O port space, interrupt vector table, and local descriptor table. Applications running in virtual-8086 mode run at privilege level 3. In Windows, protected-mode programs run at privilege levels 0 and 3.

### 11.4.3 Section Review

1. Define the following terms:
  - a. Multitasking
  - b. Segmentation
2. Define the following terms:
  - a. Segment selector
  - b. Logical address
3. (*True/False*): A segment selector points to an entry in a segment descriptor table.
4. (*True/False*): A segment descriptor contains the base location of a segment.
5. (*True/False*): A segment selector is 32 bits.
6. (*True/False*): A segment descriptor does not contain segment size information.

## 11.5 Chapter Summary

On the surface, 32-bit console mode programs look and behave like 16-bit MS-DOS programs running in text mode. Both types of programs read from standard input and write to standard output, they support command-line redirection, and they can display text in color. Beneath the surface, however, Win32 consoles and MS-DOS programs are quite different. Win32 runs in 32-bit protected mode, whereas MS-DOS runs in real-address mode. Win32 programs can call functions from the same function library used by graphical Windows applications. MS-DOS programs are limited to a smaller set of BIOS and MS-DOS interrupts that have existed since the introduction of the IBM-PC.

Types of character sets are used in Windows API functions: the 8-bit ASCII/ANSI character set and a 16-bit version of the Unicode character set.

Standard MS-Windows data types used in the API functions must be translated to MASM data types (see Table 11-1).

Console handles are 32-bit integers used for input/output in console windows. The **GetStdHandle** function retrieves a console handle. For high-level console input, call the **ReadConsole** function; for high-level output, call **WriteConsole**. When creating or opening a file, call **CreateFile**. When reading from a file, call **ReadFile**, and when writing, call **WriteFile**. **CloseHandle** closes a file. To move a file pointer, call **SetFilePointer**.

To manipulate the console screen buffer, call **SetConsoleScreenBufferSize**. To change the text color, call **SetConsoleTextAttribute**. The **WriteColors** program in this chapter demonstrated the **WriteConsoleOutputAttribute** and **WriteConsoleOutputCharacter** functions.

To get the system time, call **GetLocalTime**; to set the time, call **SetLocalTime**. Both functions use the **SYSTEMTIME** structure. The **GetDateTime** function example in this chapter returns the date and time as a 64-bit integer, specifying the number of 100-nanosecond intervals that have occurred since January 1, 1601. The **TimerStart** and **TimerStop** functions can be used to create a simple stopwatch timer.

When creating a graphical MS-Windows application, fill in a `WNDCLASS` structure with information about the program's main window class. Create a **WinMain** procedure that gets a handle to the current process, loads the icon and mouse cursor, registers the program's main window, creates the main window, shows and updates the main windows, and begins a message loop that receives and dispatches messages.

The **WinProc** procedure is responsible for handling incoming Windows messages, often activated by user actions such as a mouse click or keystroke. Our example program processes a `WM_LBUTTONDOWN` message, a `WM_CREATE` message, and a `WM_CLOSE` message. It displays popup messages when these events are detected.

Dynamic memory allocation, or heap allocation, is a tool you can use to reserve memory and free memory for use by your program. Assembly language programs can perform dynamic allocation in a couple of ways. First, they can make system calls to get blocks of memory from the operating system. Second, they can implement their own heap managers that serve requests for smaller objects. Following are the most important Win32 API calls for dynamic memory allocation:

- `GetProcessHeap` returns a 32-bit integer handle to the program's existing heap area.
- `HeapAlloc` allocates a block of memory from a heap.
- `HeapCreate` creates a new heap.
- `HeapDestroy` destroys a heap.
- `HeapFree` frees a block of memory previously allocated from a heap.
- `HeapReAlloc` reallocates and resizes a block of memory from a heap.
- `HeapSize` returns the size of a previously allocated memory block.

The memory management section of this chapter focuses on two main topics: translating logical addresses into linear addresses and translating linear addresses into physical addresses.

The selector in a logical address points to an entry in a segment descriptor table, which in turn points to a segment in linear memory. The segment descriptor contains information about the segment, including its size and type of access. There are two types of descriptor tables: a single global descriptor table (GDT) and one or more local descriptor tables (LDT).

Paging is an important feature of the IA-32 processor that makes it possible for a computer to run a combination of programs that would not otherwise fit into memory. The processor does this by initially loading only part of a program in memory, while keeping the remaining parts on disk. The processor uses a page directory, page table, and page frame to generate the physical location of data. A page directory contains pointers to page tables. A page table contains pointers to pages.

**Reading** For further reading about Windows programming, the following books may be helpful:

- Mark Russinovich and David Solomon, *Windows Internals, Parts 1 and 2.*, Microsoft Press, 2012.
- Barry Kauler, *Windows Assembly Language and System Programming*, CMP Books, 1997.
- Charles Petzold, *Programming Windows, 5th Ed.*, Microsoft Press, 1998.

## 11.6 Key Terms

|                                         |                    |
|-----------------------------------------|--------------------|
| Application Programming Interface (API) | page fault         |
| base address                            | page table         |
| commit charge frame                     | page translation   |
| console handle                          | paging             |
| console input buffer                    | physical address   |
| descriptor table                        | privilege level    |
| dynamic memory allocation               | screen buffer      |
| Global Descriptor Table (GDT)           | segment            |
| granularity                             | segment selector   |
| heap allocation                         | segmentation       |
| linear address                          | segment descriptor |
| Local Descriptor Table (LDT)            | task manager       |
| logical address                         | Unicode            |
| multitasking                            | Win32 Platform SDK |
| page directory                          |                    |

## 11.7 Review Questions and Exercises

### 11.7.1 Short Answer

1. Name the MASM data type that matches each of the following standard MS-Windows types:
  - a. BOOL
  - b. COLORREF
  - c. HANDLE
  - d. LPSTR
  - e. WPARAM
2. Which Win32 function returns a handle to standard input?
3. Which Win32 function reads a string of text from the keyboard and places the string in a buffer?
4. Describe the COORD structure.
5. Which Win32 function moves the file pointer to a specified offset relative to the beginning of a file?
6. Which Win32 function changes the title of the console window?
7. Which Win32 function lets you change the dimensions of the screen buffer?
8. Which Win32 function lets you change the size of the cursor?
9. Which Win32 function lets you change the color of subsequent text output?
10. Which Win32 function lets you copy an array of attribute values to consecutive cells of the console screen buffer?

11. Which Win32 function lets you pause a program for a specified number of milliseconds?
12. When `CreateWindowEx` is called, how is the window's appearance information transmitted to the function?
13. Name two button constants that can be used when calling the `MessageBox` function.
14. Name two icon constants that can be used when calling the `MessageBox` function.
15. Name at least three tasks performed by the `WinMain` (startup) procedure.
16. Describe the role of the `WinProc` procedure in the example program.
17. Which messages are processed by the `WinProc` procedure in the example program?
18. Describe the role of the `ErrorHandler` procedure in the example program.
19. Does the message box activated immediately after calling `CreateWindow` appear before or after the application's main window?
20. Does the message box activated by `WM_CLOSE` appear before or after the main window closes?
21. Describe a linear address.
22. How does paging relate to linear memory?
23. If paging is disabled, how does the processor translate a linear address to a physical address?
24. What advantage does paging offer?
25. Which register contains the base location of a local descriptor table?
26. Which register contains the base location of a global descriptor table?
27. How many global descriptor tables can exist?
28. How many local descriptor tables can exist?
29. Name at least four fields in a segment descriptor.
30. Which structures are involved in the paging process?
31. Which structure contains the base address of a page table?
32. Which structure contains the base address of a page frame?

### 11.7.2 Algorithm Workbench

1. Show an example call to the `ReadConsole` function.
2. Show an example call to the `WriteConsole` function.
3. Show an example call to the `CreateFile` function that will open an existing file for reading.
4. Show an example call to the `CreateFile` function that will create a new file with normal attributes, erasing any existing file by the same name.
5. Show an example call to the `ReadFile` function.
6. Show an example call to the `WriteFile` function.
7. Show an example of calling the `MessageBox` function.

## 11.8 Programming Exercises

### ★★ 1. ReadString

Implement your own version of the **ReadString** procedure, using stack parameters. Pass it a pointer to a string and an integer, indicating the maximum number of characters to be entered. Return a count (in EAX) of the number of characters actually entered. The procedure must input a string from the console and insert a null byte at the end of the string (in the position occupied by 0Dh). See Section 11.1.4 for details on the Win32 **ReadConsole** function. Write a short program that tests your procedure.

### ★★★ 2. String Input/Output

Write a program that inputs the following information from the user, using the Win32 **ReadConsole** function: first name, last name, age, phone number. Redisplay the same information with labels and attractive formatting, using the Win32 **WriteConsole** function. Do not use any procedures from the Irvine32 library.

### ★★ 3. Clearing the Screen

Write your own version of the link library's **Clsrscr** procedure that clears the screen.

### ★★ 4. Random Screen Fill

Write a program that fills each screen cell with a random character in a random color. *Extra:* Assign a 50% probability that the color of any character will be red.

### ★★ 5. DrawBox

Draw a box on the screen using line-drawing characters from the character set listed on the inside back cover of the book. *Hint:* Use the **WriteConsoleOutputCharacter** function.

### ★★★ 6. Student Records

Write a program that creates a new text file. Prompt the user for a student identification number, last name, first name, and date of birth. Write this information to the file. Input several more records in the same manner and close the file.

### ★★ 7. Scrolling Text Window

Write a program that writes 50 lines of text to the console screen buffer. Number each line. Move the console window to the top of the buffer, and begin scrolling the text upward at a steady rate (two lines per second). Stop scrolling when the console window reaches the end of the buffer.

### ★★★ 8. Block Animation

Write a program that draws a small square on the screen using several blocks (ASCII code DBh) in color. Move the square around the screen in randomly generated directions. Use a fixed delay value of 50 milliseconds. *Extra:* Use a randomly generated delay value between 10 and 100 milliseconds.

### ★★ 9. Last Access Date of a File

Write a procedure named **LastAccessDate** that fills a **SYSTEMTIME** structure with the date and time stamp information of a file. Pass the offset of a filename in EDX, and pass the offset of



a SYSTEMTIME structure in ESI. If the function fails to find the file, set the Carry flag. When you implement this function, you will need to open the file, get its handle, pass the handle to **GetFileTime**, pass its output to **FileTimeToSystemTime**, and close the file. Write a test program that calls your procedure and prints out the date when a particular file was last accessed. Sample:

```
ch11_09.asm was last accessed on: 6/16/2005
```

### ★★ 10. Reading a Large File

Modify the ReadFile.asm program in Section 11.1.8 so that it can read files larger than its input buffer. Reduce the buffer size to 1024 bytes. Use a loop to continue reading and displaying the file until it can read no more data. If you plan to display the buffer with WriteString, remember to insert a null byte at the end of the buffer data.

### ★★★ 11. Linked List

*Advanced:* Implement a singly linked list, using the dynamic memory allocation functions presented in this chapter. Each link should be a structure named Node (see Chapter 10) containing an integer value and a pointer to the next link in the list. Using a loop, prompt the user for as many integers as they want to enter. As each integer is entered, allocate a Node object, insert the integer in the Node, and append the Node to the linked list. When a value of 0 is entered, stop the loop. Finally, display the entire list from beginning to end. *This project should only be attempted if you have previously created linked lists in a high-level language.*

### End Notes

1. Source: Microsoft MSDN Documentation, at [http://msdn.microsoft.com/en-us/library/windows/desktop/ms682073\(v=vs.85\).aspx](http://msdn.microsoft.com/en-us/library/windows/desktop/ms682073(v=vs.85).aspx)
2. The Pentium Pro and later processors permit a 36-bit address option, but it will not be covered here.

# FLOATING-POINT PROCESSING AND INSTRUCTION ENCODING

- 12.1 Floating-Point Binary Representation
  - 12.1.1 IEEE Binary Floating-Point Representation
  - 12.1.2 The Exponent
  - 12.1.3 Normalized Binary Floating-Point Numbers
  - 12.1.4 Creating the IEEE Representation
  - 12.1.5 Converting Decimal Fractions to Binary Reals
  - 12.1.6 Section Review
- 12.2 Floating-Point Unit
  - 12.2.1 FPU Register Stack
  - 12.2.2 Rounding
  - 12.2.3 Floating-Point Exceptions
  - 12.2.4 Floating-Point Instruction Set
  - 12.2.5 Arithmetic Instructions
  - 12.2.6 Comparing Floating-Point Values
  - 12.2.7 Reading and Writing Floating-Point Values
  - 12.2.8 Exception Synchronization
  - 12.2.9 Code Examples
  - 12.2.10 Mixed-Mode Arithmetic
  - 12.2.11 Masking and Unmasking Exceptions
  - 12.2.12 Section Review
- 12.3 x86 Instruction Encoding
  - 12.3.1 Instruction Format
  - 12.3.2 Single-Byte Instructions
  - 12.3.3 Move Immediate to Register
  - 12.3.4 Register-Mode Instructions
  - 12.3.5 Processor Operand-Size Prefix
  - 12.3.6 Memory-Mode Instructions
  - 12.3.7 Section Review
- 12.4 Chapter Summary
- 12.5 Key Terms
- 12.6 Review Questions and Exercises
  - 12.6.1 Short Answer
  - 12.6.2 Algorithm Workbench
- 12.7 Programming Exercises

## 12.1 Floating-Point Binary Representation

A floating-point decimal number contains three components: a sign, a significand, and an exponent. In the number  $-1.23154 \times 10^5$ , for example, the sign is negative, the significand is 1.23154, and the exponent is 5. (Although slightly less correct, the term *mantissa* is sometimes substituted for *significand*.)

**Finding the Intel x86 Documentation.** To get the most out of this chapter, get free electronic copies of the *Intel 64 and IA-32 Architectures Software Developer's Manual*, Vols. 1 and 2. Point your Web browser to [www.intel.com](http://www.intel.com), and search for *IA-32 manuals*.

### 12.1.1 IEEE Binary Floating-Point Representation

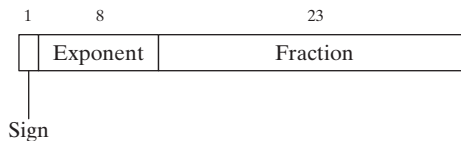
x86 processors use three floating-point binary storage formats specified in the *Standard 754-1985 for Binary Floating-Point Arithmetic* produced by the IEEE organization. Table 12-1 describes their characteristics.<sup>1</sup>

Table 12-1 IEEE Floating-Point Binary Formats.

|                                  |                                                                                                                                                                                                                  |
|----------------------------------|------------------------------------------------------------------------------------------------------------------------------------------------------------------------------------------------------------------|
| <b>Single Precision</b>          | 32 bits: 1 bit for the sign, 8 bits for the exponent, and 23 bits for the fractional part of the significand. Approximate normalized range: $2^{-126}$ to $2^{127}$ . Also called a <i>short real</i> .          |
| <b>Double Precision</b>          | 64 bits: 1 bit for the sign, 11 bits for the exponent, and 52 bits for the fractional part of the significand. Approximate normalized range: $2^{-1022}$ to $2^{1023}$ . Also called a <i>long real</i> .        |
| <b>Double Extended Precision</b> | 80 bits: 1 bit for the sign, 16 bits for the exponent, and 63 bits for the fractional part of the significand. Approximate normalized range: $2^{-16382}$ to $2^{16383}$ . Also called an <i>extended real</i> . |

Because the three formats are so similar, we will focus on the single-precision format (Fig. 12-1). The 32 bits are arranged with the most significant bit (MSB) on the left. The segment marked *fraction* indicates the fractional part of the significand. As you might expect, the individual bytes are stored in little-endian order [least significant bit (LSB) at the starting address].

FIGURE 12-1 Single-precision format.



#### The Sign

If the sign bit is 1, the number is negative; if the bit is 0, the number is positive. Zero is considered positive.

#### The Significand

In the floating-point number represented by the expression  $m * b^e$ ,  $m$  is called the significand, or mantissa;  $b$  is the base; and  $e$  is the exponent. The *significand* (or mantissa) of a floating-point number consists of the decimal digits to the left and right of the decimal point. In Chapter 1 we introduced the concept of weighted positional notation when explaining the binary, decimal, and hexadecimal numbering systems. The same concept can be extended to include the fractional part of a floating-point number. For example, the decimal value 123.154 is represented by the following sum:

$$123.154 = (1 \times 10^2) + (2 \times 10^1) + (3 \times 10^0) + (1 \times 10^{-1}) + (5 \times 10^{-2}) + (4 \times 10^{-3})$$

All digits to the left of the decimal point have positive exponents, and all digits to the right side have negative exponents.

Binary floating-point numbers also use weighted positional notation. The floating-point binary value 11.1011 is expressed as

$$11.1011 = (1 \times 2^1) + (1 \times 2^0) + (1 \times 2^{-1}) + (0 \times 2^{-2}) + (1 \times 2^{-3}) + (1 \times 2^{-4})$$

Another way to express the values to the right of the binary point is to list them as a sum of fractions whose denominators are powers of 2. In our sample, the sum is 11/16 (or 0.6875):

$$.1011 = 1/2 + 0/4 + 1/8 + 1/16 = 11/16$$

Generating the decimal fraction is fairly intuitive. The decimal numerator (11) represents the binary bit pattern 1011. If  $e$  is the number of significant bits to the right of the binary point, the decimal denominator is  $2^e$ . In our example,  $e = 4$ , so  $2^e = 16$ . Table 12-2 shows additional examples of translating binary floating-point notation to base-10 fractions. The last entry in the table contains the smallest fraction that can be stored in a 23-bit normalized significand. For quick reference, Table 12-3 lists examples of binary floating-point numbers alongside their equivalent decimal fractions and decimal values.

Table 12-2 Examples: Translating Binary Floating-Point to Fractions.

| Binary Floating-Point      | Base-10 Fraction |
|----------------------------|------------------|
| 11.11                      | 3 3/4            |
| 101.0011                   | 5 3/16           |
| 1101.100101                | 13 37/64         |
| 0.00101                    | 5/32             |
| 1.011                      | 1 3/8            |
| 0.000000000000000000000001 | 1/8388608        |

Table 12-3 Binary and Decimal Fractions.

| Binary | Decimal Fraction | Decimal Value |
|--------|------------------|---------------|
| .1     | 1/2              | .5            |
| .01    | 1/4              | .25           |
| .001   | 1/8              | .125          |
| .0001  | 1/16             | .0625         |
| .00001 | 1/32             | .03125        |

### ***The Significand's Precision***

The entire continuum of real numbers cannot be represented in any floating-point format having a finite number of bits. Suppose, for example, a simplified floating-point format had 5-bit significands. There would be no way to represent values falling between 1.1111 and 10.000 binary. The binary value 1.11111, for example, requires a more precise significand. Extending this idea to the IEEE double-precision format, we see that its 53-bit significand cannot represent a binary value requiring 54 or more bits.

### 12.1.2 The Exponent

Single precision exponents are stored as 8-bit unsigned integers with a bias of 127. The number's actual exponent must be added to 127. Consider the binary value  $1.101 \times 2^5$ : After the actual exponent (5) is added to 127, the biased exponent (132) is stored in the number's representation. Table 12-4 shows examples of exponents in signed decimal, then biased decimal, and finally unsigned binary. The biased exponent is always positive, between 1 and 254. As stated earlier, the actual exponent range is from  $-126$  to  $+127$ . The range was chosen so the smallest possible exponent's reciprocal cannot cause an overflow.

TABLE 12-4 Sample Exponents Represented in Binary.

| Exponent (E) | Biased (E + 127) | Binary   |
|--------------|------------------|----------|
| +5           | 132              | 10000100 |
| 0            | 127              | 01111111 |
| -10          | 117              | 01110101 |
| +127         | 254              | 11111110 |
| -126         | 1                | 00000001 |
| -1           | 126              | 01111110 |

### 12.1.3 Normalized Binary Floating-Point Numbers

Most floating-point binary numbers are stored in *normalized form* so as to maximize the precision of the significand. Given any floating-point binary number, you can normalize it by shifting the binary point until a single "1" appears to the left of the binary point. The exponent expresses the number of positions the binary point is moved left (positive exponent) or right (negative exponent). Here are examples:

| Denormalized | Normalized            |
|--------------|-----------------------|
| 1110.1       | $1.1101 \times 2^3$   |
| .000101      | $1.01 \times 2^{-4}$  |
| 1010001.     | $1.010001 \times 2^6$ |

**Denormalized Values** To reverse the normalizing operation is to *denormalize* (or unnormalize) a binary floating-point number. Shift the binary point until the exponent is zero. If the exponent is positive  $n$ , shift the binary point  $n$  positions to the right; if the exponent is negative  $n$ , shift the binary point  $n$  positions to the left, filling leading zeros if necessary.

### 12.1.4 Creating the IEEE Representation

#### Real Number Encodings

Once the sign bit, exponent, and significand fields are normalized and encoded, it's easy to generate a complete binary IEEE short real. Using Fig. 12-1 as a reference, we can place the sign bit first, the exponent bits next, and the fractional part of the significand last. For example, binary  $1.101 \times 2^0$  is represented as follows:

- Sign bit: 0
- Exponent: 01111111
- Fraction: 1010000000000000000000

The biased exponent (01111111) is the binary representation of decimal 127. All normalized significands have a 1 to the left of the binary point, so there is no need to explicitly encode the bit. Additional examples are shown in Table 12-5.

TABLE 12-5 Examples of Single Precision Bit Encodings.

| Binary Value    | Biased Exponent | Sign, Exponent, Fraction          |
|-----------------|-----------------|-----------------------------------|
| -1.11           | 127             | 1 01111111 1100000000000000000000 |
| +1101.101       | 130             | 0 1000010 1011010000000000000000  |
| -.00101         | 124             | 1 01111100 0100000000000000000000 |
| +100111.0       | 132             | 0 10000100 0011100000000000000000 |
| +.0000001101011 | 120             | 0 01111000 1010110000000000000000 |

The IEEE specification includes several real-number and non-number encodings.

- Positive and negative zero
- Denormalized finite numbers
- Normalized finite numbers
- Positive and negative infinity
- Non-numeric values (NaN, known as *Not a Number*)
- Indefinite numbers

Indefinite numbers are used by the floating-point unit (FPU) as responses to some invalid floating-point operations.

**Normalized and Denormalized** *Normalized finite numbers* are all the nonzero finite values that can be encoded in a normalized real number between zero and infinity. Although it would seem that all finite nonzero floating-point numbers should be normalized, it is not possible when their values are close to zero. This happens when the FPU cannot shift the binary point to a normalized position, given the limitation posed by the range of the exponent. Suppose the FPU computes a result of  $1.0101111 \times 2^{-129}$ , which has an exponent that is too small to be stored in a single-precision number. An underflow exception condition is generated, and the number is gradually denormalized by shifting the binary point left 1 bit at a time until the exponent reaches a valid range:

$$\begin{aligned}
 &1.01011110000000000001111 \times 2^{-129} \\
 &0.10101111000000000000111 \times 2^{-128} \\
 &0.01010111100000000000011 \times 2^{-127} \\
 &0.00101011110000000000001 \times 2^{-126}
 \end{aligned}$$

In this example, some loss of precision occurred in the significand as a result of the shifting of the binary point.

**Positive and Negative Infinity** Positive infinity ( $+\infty$ ) represents the maximum positive real number, and negative infinity ( $-\infty$ ) represents the maximum negative real number. You can compare infinities to other values:  $-\infty$  is less than  $+\infty$ ,  $-\infty$  is less than any finite number, and  $+\infty$  is greater than any finite number. Either infinity may represent a floating-point overflow condition. The result of a computation cannot be normalized because its exponent would be too large to be represented by the available number of exponent bits.

**NaNs** NaNs are bit patterns that do not represent any valid real number. The x86 includes two types of NaNs: A *quiet NaN* can propagate through most arithmetic operations without causing an exception. A *signaling NaN* can be used to generate a floating-point invalid operation exception. A compiler might fill an uninitialized array with signaling NaN values so that any attempt to perform calculations on the array will generate an exception. A quiet NaN can be used to hold diagnostic information created during debugging sessions. A program is free to encode any information in a NaN it wishes. The FPU does not attempt to perform operations on NaNs. The Intel manuals contain a set of rules that determine instruction results when combinations of the two types of NaNs are used as operands.<sup>2</sup>

**Specific Encodings** There are several specific encodings for values often encountered in floating-point operations, listed in Table 12-6. Bit positions marked with the letter x can be either 1 or 0. QNaN is a quiet NaN, and SNaN is a signaling NaN.

Table 12-6 Specific Single-Precision Encodings.

| Value             | Sign, Exponent, Significand |                                                    |
|-------------------|-----------------------------|----------------------------------------------------|
| Positive zero     | 0                           | 00000000 0000000000000000000000                    |
| Negative zero     | 1                           | 00000000 0000000000000000000000                    |
| Positive infinity | 0                           | 11111111 0000000000000000000000                    |
| Negative infinity | 1                           | 11111111 0000000000000000000000                    |
| QNaN              | x                           | 11111111 1xxxxxxxxxxxxxxxxxxxxxxxxxxx              |
| SNaN              | x                           | 11111111 0xxxxxxxxxxxxxxxxxxxxxxxxxxx <sup>a</sup> |

<sup>a</sup>SNaN significand field begins with 0, but at least one of the remaining bits must be 1.

### 12.1.5 Converting Decimal Fractions to Binary Reals

When a decimal fraction can be represented as a sum of fractions in the form ( $1/2 + 1/4 + 1/8 + \dots$ ), it is fairly easy for you to discover the corresponding binary real. In Table 12-7, most of the fractions in the left column are not in a form that translates easily to binary. They can, however, be written as in the second column.

Many real numbers, such as  $1/10$  (0.1) or  $1/100$  (.01), cannot be represented by a finite number of binary digits. Such a fraction can only be approximated by a sum of fractions whose denominators are powers of 2. Imagine how currency values such as \$39.95 are affected!

**Alternate Method, Using Binary Long Division** When small decimal values are involved, an easy way to convert decimal fractions into binary is to first convert the numerator and denominator to binary and then perform long division. For example, decimal 0.5 is represented as the fraction 5/10. Decimal 5 is binary 0101, and decimal 10 is binary 1010. Performing the binary long division, we find that the quotient is 0.1 binary:

$$\begin{array}{r}
 \phantom{1010} .1 \\
 1010 \overline{) 0101.0} \\
 \underline{-1010} \phantom{0} \\
 0
 \end{array}$$

TABLE 12-7 Examples of Decimal Fractions and Binary Reals.

| Decimal Fraction | Factored As...  | Binary Real |
|------------------|-----------------|-------------|
| 1/2              | 1/2             | .1          |
| 1/4              | 1/4             | .01         |
| 3/4              | 1/2 + 1/4       | .11         |
| 1/8              | 1/8             | .001        |
| 7/8              | 1/2 + 1/4 + 1/8 | .111        |
| 3/8              | 1/4 + 1/8       | .011        |
| 1/16             | 1/16            | .0001       |
| 3/16             | 1/8 + 1/16      | .0011       |
| 5/16             | 1/4 + 1/16      | .0101       |

When 1010 binary is subtracted from the dividend the remainder is zero, and the division stops. Therefore, the decimal fraction 5/10 equals 0.1 binary. We will call this approach the *binary long division method*.<sup>3</sup>

**Representing 0.2 in Binary** Let's convert decimal 0.2 (2/10) to binary using the binary long division method. First, we divide binary 10 by binary 1010 (decimal 10):

$$\begin{array}{r}
 \phantom{1010} .00110011 \text{ (etc.)} \\
 1010 \overline{) 10.00000000} \\
 \underline{-1010} \phantom{00000000} \\
 1100 \phantom{00000000} \\
 \underline{-1010} \phantom{00000000} \\
 10000 \phantom{00000000} \\
 \underline{-1010} \phantom{00000000} \\
 1100 \phantom{00000000} \\
 \underline{-1010} \phantom{00000000} \\
 \phantom{1100} \phantom{00000000} \text{ etc.}
 \end{array}$$



The first quotient large enough to use is 10000. After dividing 1010 into 10000, the remainder is 110. Appending another zero, the new dividend is 1100. After dividing 1010 into 1100, the remainder is 10. After appending three zeros, the new dividend is 10000. This is the same dividend we started with. From this point on, the sequence of the bits in the quotient repeats (0011. . .), so we know that an exact quotient will not be found and 0.2 cannot be represented by a finite number of bits. The single-precision encoded significand is 00110011001100110011001.

### **Converting Single-Precision Values to Decimal**

The following are suggested steps when converting a IEEE single-precision value to decimal:

1. If the MSB is 1, the number is negative; otherwise, it is positive.
2. The next 8 bits represent the exponent. Subtract binary 01111111 (decimal 127), producing the unbiased exponent. Convert the unbiased exponent to decimal.
3. The next 23 bits represent the significand. Notate a “1.”, followed by the significand bits. Trailing zeros can be ignored. Create a floating-point binary number, using the significand, the sign determined in step 1, and the exponent calculated in step 2.
4. Denormalize the binary number produced in step 3. (Shift the binary point the number of places equal to the value of the exponent. Shift right if the exponent is positive, or left if the exponent is negative.)
5. From left to right, use weighted positional notation to form the decimal sum of the powers of 2 represented by the floating-point binary number.

**Example: Convert IEEE (0 1000010 010110000000000000000) to Decimal**

1. The number is positive.
2. The unbiased exponent is binary 00000011, or decimal 3.
3. Combining the sign, exponent, and significand, the binary number is  $+1.01011 \times 2^3$ .
4. The denormalized binary number is  $+1010.11$ .
5. The decimal value is  $+10 \frac{3}{4}$ , or  $+10.75$ .

### **12.1.6 Section Review**

1. Why doesn't the single-precision real format permit an exponent of  $-127$ ?
2. Why doesn't the single-precision real format permit an exponent of  $+128$ ?
3. In the IEEE double-precision format, how many bits are reserved for the fractional part of the significand?
4. In the IEEE single-precision format, how many bits are reserved for the exponent?

## **12.2 Floating-Point Unit**

The Intel 8086 processor was designed to handle only integer arithmetic. This turned out to be a problem for graphics and calculation-intensive software using floating-point calculations. It was possible to emulate floating-point arithmetic purely through software, but the performance penalty was severe. Programs such as *AutoCad* (by Autodesk) demanded a more powerful way to perform floating-point math. Intel sold a separate floating-point coprocessor chip named the 8087, and upgraded it along with each processor generation. With the advent of the Intel486, floating-point hardware was integrated into the main CPU and called the FPU.

### 12.2.1 FPU Register Stack

The FPU does not use the general-purpose registers (EAX, EBX, etc.). Instead, it has its own set of registers called a *register stack*. It loads values from memory into the register stack, performs calculations, and stores stack values into memory. FPU instructions evaluate mathematical expressions in *postfix* format, in much the same way as Hewlett-Packard calculators. The following, for example, is called an *infix expression*:  $(5 * 6) + 4$ . The postfix equivalent is

$$5\ 6\ *\ 4\ +$$

The infix expression  $(A + B) * C$  requires parentheses to override the default precedence rules (multiplication before addition). The equivalent postfix expression does not require parentheses:

$$A\ B\ +\ C\ *$$

**Expression Stack** A stack holds intermediate values during the evaluation of postfix expressions. Figure 12-2 shows the steps required to evaluate the postfix expression  $5\ 6\ *\ 4\ -$ . The stack entries are labeled ST(0) and ST(1), with ST(0) indicating where the stack pointer would normally be pointing.

FIGURE 12-2 Evaluating the postfix expression  $5\ 6\ *\ 4\ -$ .

| Left to Right | Stack                                            |                  | Action                                                 |
|---------------|--------------------------------------------------|------------------|--------------------------------------------------------|
| 5             | 5<br>┌───┐<br>│ 5 │<br>└───┘                     | ST (0)           | push 5                                                 |
| 5 6           | 5<br>┌───┐<br>│ 5 │<br>├───┤<br>│ 6 │<br>└───┘   | ST (1)<br>ST (0) | push 6                                                 |
| 5 6 *         | 30<br>┌───┐<br>│ 30 │<br>└───┘                   | ST (0)           | Multiply ST(1) by ST(0) and pop ST(0) off the stack.   |
| 5 6 * 4       | 30<br>┌───┐<br>│ 30 │<br>├───┤<br>│ 4 │<br>└───┘ | ST (1)<br>ST (0) | push 4                                                 |
| 5 6 * 4 -     | 26<br>┌───┐<br>│ 26 │<br>└───┘                   | ST (0)           | Subtract ST(0) from ST(1) and pop ST(0) off the stack. |

Commonly used methods for translating infix expressions to postfix are well documented in introductory computer science texts and on the Internet, so we will skip them here. Table 12-8 contains a few examples of equivalent expressions.

TABLE 12-8 Infix to Postfix Examples.

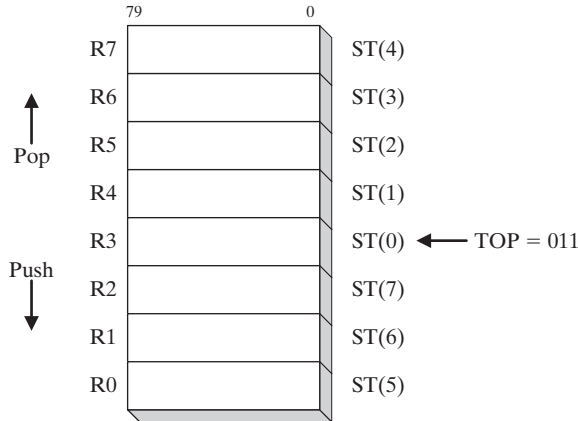
| Infix                   | Postfix           |
|-------------------------|-------------------|
| A + B                   | A B +             |
| (A - B) / D             | A B - D /         |
| (A + B) * (C + D)       | A B + C D + *     |
| ((A + B) / C) * (E - F) | A B + C / E F - * |

### FPU Data Registers

The FPU has eight individually addressable 80-bit data registers named R0 through R7 (see Fig. 12-3). Together, they are called a *register stack*. A three-bit field named TOP in the FPU status

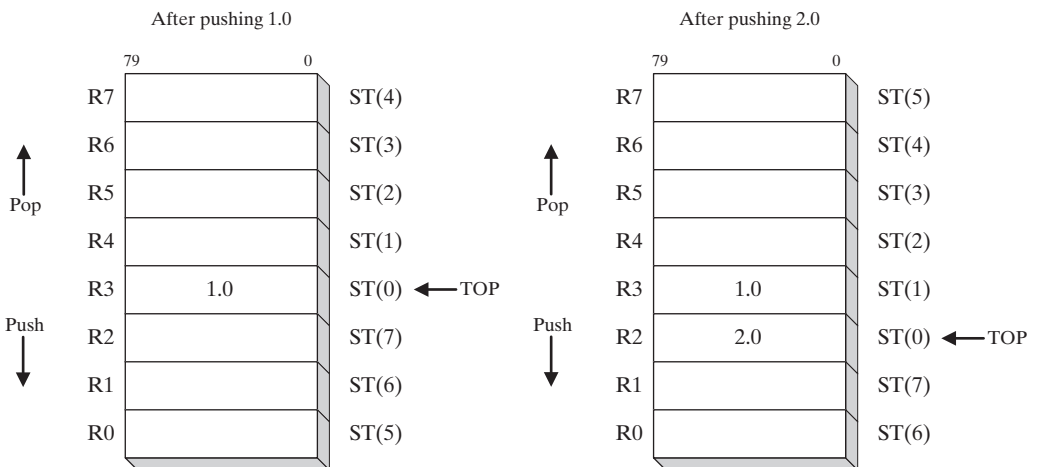
word identifies the register number that is currently the top of the stack. In Fig. 12-3, for example, TOP equals binary 011, identifying R3 as the top of the stack. This stack location is also known as ST(0) (or simply ST) when writing floating-point instructions. The last register is ST(7).

FIGURE 12-3 Floating-point data register stack.



As we might expect, a *push* operation (also called *load*) decrements TOP by 1 and copies an operand into the register identified as ST(0). If TOP equals 0 before a push, TOP wraps around to register R7. A *pop* operation (also called *store*) copies the data at ST(0) into an operand, then adds 1 to TOP. If TOP equals 7 before the pop, it wraps around to register R0. If loading a value into the stack would result in overwriting existing data in the register stack, a *floating-point exception* is generated. Figure 12-4 shows the same stack after 1.0 and 2.0 have been pushed (loaded) on the stack.

FIGURE 12-4 FPU stack after pushing 1.0 and 2.0.



Although it is interesting to understand how the FPU implements the stack using a limited set of registers, we need only focus on the ST(*n*) notation, where ST(0) is always the top of stack.

From this point forward, we refer to stack registers as ST(0), ST(1), and so on. Instruction operands cannot refer directly to register numbers.

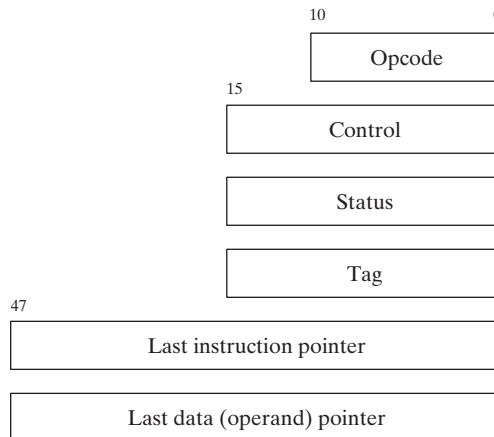
Floating-point values in registers use the IEEE 10-byte *extended real* format (also known as *temporary real*). When the FPU stores the result of an arithmetic operation in memory, it translates the result into one of the following formats: integer, long integer, single precision (short real), double precision (long real), or packed binary-coded decimal (BCD).

### Special-Purpose Registers

The FPU has six *special-purpose* registers (see Fig. 12-5):

- **Opcode register:** stores the opcode of the last noncontrol instruction executed.
- **Control register:** controls the precision and rounding method used by the FPU when performing calculations. You can also use it to mask out (hide) individual floating-point exceptions.
- **Status register:** contains the top-of-stack pointer, condition codes, and warnings about exceptions.
- **Tag register:** indicates the contents of each register in the FPU data-register stack. It uses two bits per register to indicate whether the register contains a valid number, zero, or a special value (NaN, infinity, denormal, or unsupported format) or is empty.
- **Last instruction pointer register:** stores a pointer to the last noncontrol instruction executed.
- **Last data (operand) pointer register:** stores a pointer to a data operand, if any, used by the last instruction executed.

FIGURE 12-5 FPU special-purpose registers.



The special-purpose registers are used by operating systems to preserve state information when switching between tasks. We mentioned state preservation in Chapter 2 when explaining how the CPU performs multitasking.

### 12.2.2 Rounding

The FPU attempts to generate an infinitely accurate result from a floating-point calculation. In many cases this is impossible because the destination operand may not be able to accurately represent the calculated result. For example, suppose a certain storage format would only permit three fractional bits. It would permit us to store values such as 1.011 or 1.101, but not 1.0101. Suppose

the precise result of a calculation produced  $+1.0111$  (decimal 1.4375). We could either round the number up to the next higher value by adding  $.0001$  or round it downward to by subtracting  $.0001$ :

- (a)  $1.0111 \rightarrow 1.100$
- (b)  $1.0111 \rightarrow 1.011$

If the precise result were negative, adding  $-.0001$  would move the rounded result closer to  $-\infty$ . Subtracting  $-.0001$  would move the rounded result closer to both zero and  $+\infty$ :

- (a)  $-1.0111 \rightarrow -1.100$
- (b)  $-1.0111 \rightarrow -1.011$

The FPU lets you select one of four rounding methods:

- *Round to nearest even*: The rounded result is the closest to the infinitely precise result. If two values are equally close, the result is an even value (LSB = 0).
- *Round down toward  $-\infty$* : The rounded result is less than or equal to the infinitely precise result.
- *Round up toward  $+\infty$* : The rounded result is greater than or equal to the infinitely precise result.
- *Round toward zero*: (also known as *truncation*): The absolute value of the rounded result is less than or equal to the infinitely precise result.

**FPU Control Word** The FPU control word contains two bits named the *RC field* that specify which rounding method to use. The field values are as follows:

- 00 binary: Round to nearest even (default).
- 01 binary: Round down toward negative infinity.
- 10 binary: Round up toward positive infinity.
- 11 binary: Round toward zero (truncate).

*Round to nearest even* is the default, and is considered to be the most accurate and appropriate for most application programs. Table 12-9 shows how the four rounding methods would be applied to binary  $+1.0111$ . Similarly, Table 12-10 shows the possible roundings of binary  $-1.0111$ .

TABLE 12-9 Example: Rounding  $+1.0111$ .

| Method                      | Precise Result | Rounded |
|-----------------------------|----------------|---------|
| Round to nearest even       | 1.0111         | 1.100   |
| Round down toward $-\infty$ | 1.0111         | 1.011   |
| Round toward $+\infty$      | 1.0111         | 1.100   |
| Round toward zero           | 1.0111         | 1.011   |

TABLE 12-10 Example: Rounding  $-1.0111$ .

| Method                  | Precise Result | Rounded |
|-------------------------|----------------|---------|
| Round to nearest (even) | -1.0111        | -1.100  |
| Round toward $-\infty$  | -1.0111        | -1.100  |
| Round toward $+\infty$  | -1.0111        | -1.011  |
| Round toward zero       | -1.0111        | -1.011  |

### 12.2.3 Floating-Point Exceptions

In every program, things can go wrong, and the FPU has to deal with the results. Consequently, it recognizes and detects six types of exception conditions: Invalid operation (#I), Divide by zero (#Z), Denormalized operand (#D), Numeric overflow (#O), Numeric underflow (#U), and Inexact precision (#P). The first three (#I, #Z, and #D) are detected before any arithmetic operation occurs. The latter three (#O, #U, and #P) are detected after an operation occurs.

Each exception type has a corresponding flag bit and mask bit. When a floating-point exception is detected, the processor sets the matching flag bit. For each exception flagged by the processor, there are two courses of action:

- If the corresponding mask bit is **set**, the processor handles the exception automatically and lets the program continue.
- If the corresponding mask bit is **clear**, the processor invokes a software exception handler.

The processor's masked (automatic) responses are generally acceptable for most programs. Custom exception handlers can be used in cases where specific responses are required by the application. A single instruction can trigger multiple exceptions, so the processor keeps an ongoing record of all exceptions occurring since the last time exceptions were cleared. After a sequence of calculations completes, you can check to see if any exceptions occurred.

### 12.2.4 Floating-Point Instruction Set

The FPU instruction set is somewhat complex, so we will attempt here to give you an overview of its capabilities, along with specific examples that demonstrate code typically generated by compilers. In addition, we will see how you can exercise control over the FPU by changing its rounding mode. The instruction set contains the following basic categories of instructions:

- Data transfer
- Basic arithmetic
- Comparison
- Transcendental
- Load constants (specialized predefined constants only)
- x87 FPU control
- x87 FPU and SIMD state management

Floating-point instruction names begin with the letter F to distinguish them from CPU instructions. The second letter of the instruction mnemonic (often B or I) indicates how a memory operand is to be interpreted: B indicates a BCD operand, and I indicates a binary integer operand. If neither is specified, the memory operand is assumed to be in real-number format. For example, FBLD operates on BCD numbers, FILD operates on integers, and FLD operates on real numbers.

|                                                                                          |
|------------------------------------------------------------------------------------------|
| Table B-3 in Appendix B contains a reference listing of x86 floating-point instructions. |
|------------------------------------------------------------------------------------------|

**Operands** A floating-point instruction can have zero operands, one operand, or two operands. If there are two operands, one must be a floating-point register. There are no immediate operands, but certain predefined constants (such as 0.0,  $\pi$ , and  $\log_2 10$ ) can be loaded into the stack.

General-purpose registers such as EAX, EBX, ECX, and EDX cannot be operands. (The only exception is FSTSW, which stores the FPU status word in AX.) Memory-to-memory operations are not permitted.

Integer operands must be loaded into the FPU from memory (never from CPU registers); they are automatically converted to floating-point format. Similarly, when storing floating-point values into integer memory operands, the values are automatically truncated or rounded into integers.

### **Initialization (FINIT)**

The FINIT instruction initializes the FPU. It sets the FPU control word to 037Fh, which masks (hides) all floating-point exceptions, sets rounding to nearest even, and sets the calculation precision to 64 bits. We recommend calling FINIT at the beginning of your programs, so you know the starting state of the processor.

### **Floating-Point Data Types**

Let's quickly review the floating-point data types supported by MASM (QWORD, TBYTE, REAL4, REAL8, and REAL10), listed in Table 12-11. You will need to use these types when defining memory operands for FPU instructions. For example, when loading a floating-point variable into the FPU stack, the variable is defined as REAL4, REAL8, or REAL10:

```
.data
bigVal REAL10 1.212342342234234243E+864
.code
fld bigVal ; load variable into stack
```

Table 12-11 Intrinsic Data Types.

| Type   | Usage                               |
|--------|-------------------------------------|
| QWORD  | 64-bit integer                      |
| TBYTE  | 80-bit (10-byte) integer            |
| REAL4  | 32-bit (4-byte) IEEE short real     |
| REAL8  | 64-bit (8-byte) IEEE long real      |
| REAL10 | 80-bit (10-byte) IEEE extended real |

### **Load Floating-Point Value (FLD)**

The FLD (load floating-point value) instruction copies a floating-point operand to the top of the FPU stack [known as ST(0)]. The operand can be a 32-bit, 64-bit, or 80-bit memory operand (REAL4, REAL8, REAL10) or another FPU register:

```
FLD m32fp
FLD m64fp
FLD m80fp
FLD ST(i)
```

**Memory Operand Types** FLD supports the same memory operand types as MOV. Here are examples:

```

.data
array REAL8 10 DUP(?)
.code
fld array           ; direct
fld [array+16]     ; direct-offset
fld REAL8 PTR[esi] ; indirect
fld array[esi]     ; indexed
fld array[esi*8]   ; indexed, scaled
fld array[esi*TYPE array] ; indexed, scaled
fld REAL8 PTR[ebx+esi] ; base-index
fld array[ebx+esi] ; base-index-displacement
fld array[ebx+esi*TYPE array] ; base-index-displacement, scaled

```

*Example* The following example loads two direct operands on the FPU stack:

```

.data
dblOne   REAL8 234.56
dblTwo   REAL8 10.1
.code
fld dblOne           ; ST(0) = dblOne
fld dblTwo           ; ST(0) = dblTwo, ST(1) = dblOne

```

The following figure shows the stack contents after executing each instruction:

|            |       |        |
|------------|-------|--------|
| fld dblOne | ST(0) | 234.56 |
| fld dblTwo | ST(1) | 234.56 |
|            | ST(0) | 10.1   |

When the second FLD executes, TOP is decremented, causing the stack element previously labeled ST(0) to become ST(1).

*FILD* The FILD (load integer) instruction converts a 16-, 32-, or 64-bit signed integer source operand to double-precision floating point and loads it into ST(0). The source operand's sign is preserved. We will demonstrate its use in Section 12.2.10 (Mixed-Mode Arithmetic). FILD supports the same memory operand types as MOV (indirect, indexed, base-indexed, etc.).

*Loading Constants* The following instructions load specialized constants on the stack. They have no operands:

- The FLD1 instruction pushes 1.0 onto the register stack.
- The FLDL2T instruction pushes  $\log_2 10$  onto the register stack.
- The FLDL2E instruction pushes  $\log_2 e$  onto the register stack.
- The FLDPI instruction pushes  $\pi$  onto the register stack.
- The FLDLG2 instruction pushes  $\log_{10} 2$  onto the register stack.
- The FLDLN2 instruction pushes  $\log_e 2$  onto the register stack.
- The FLDZ (load zero) instruction pushes 0.0 on the FPU stack.



### Store Floating-Point Value (FST, FSTP)

The FST (store floating-point value) instruction copies a floating-point operand from the top of the FPU stack into memory. FST supports the same memory operand types as FLD. The operand can be a 32-bit, 64-bit, or 80-bit memory operand (REAL4, REAL8, REAL10) or it can be another FPU register:

```
FST  m32fp          FST  m80fp
FST  m64fp          FST  ST(i)
```

FST does not pop the stack. The following instructions store ST(0) into memory. Let's assume ST(0) equals 10.1 and ST(1) equals 234.56:

```
fst  dblThree      ; 10.1
fst  dblFour       ; 10.1
```

Intuitively, we might have expected `dblFour` to equal 234.56. But the first FST instruction left 10.1 in ST(0). If our intention is to copy ST(1) into `dblFour`, we must use the FSTP instruction.

**FSTP** The FSTP (store floating-point value and pop) instruction copies the value in ST(0) to memory and pops ST(0) off the stack. Let's assume ST(0) equals 10.1 and ST(1) equals 234.56 before executing the following instructions:

```
fstp dblThree     ; 10.1
fstp dblFour      ; 234.56
```

After execution, the two values have been logically removed from the stack. Physically, the TOP pointer is incremented each time FSTP executes, changing the location of ST(0).

The FIST (store integer) instruction converts the value in ST(0) to signed integer and stores the result in the destination operand. Values can be stored as words or doublewords. We will demonstrate its use in Section 12.2.10 (Mixed-Mode Arithmetic). FIST supports the same memory operand types as FST.

### 12.2.5 Arithmetic Instructions

The basic arithmetic operations are listed in Table 12-12. Arithmetic instructions all support the same memory operand types as FLD (load) and FST (store), so operands can be indirect, indexed, base-index, and so on.

Table 12-12 Basic Floating-Point Arithmetic Instructions.

|              |                                  |
|--------------|----------------------------------|
| <b>FCHS</b>  | Change sign                      |
| <b>FADD</b>  | Add source to destination        |
| <b>FSUB</b>  | Subtract source from destination |
| <b>FSUBR</b> | Subtract destination from source |
| <b>FMUL</b>  | Multiply source by destination   |
| <b>FDIV</b>  | Divide destination by source     |
| <b>FDIVR</b> | Divide source by destination     |

**FCFS and FABS**

The FCFS (change sign) instruction reverses the sign of the floating-point value in ST(0). The FABS (absolute value) instruction clears the sign of the number in ST(0) to create its absolute value. Neither instruction has operands:

```
FCHS
FABS
```

**FADD, FADDP, FIADD**

The FADD (add) instruction has the following formats, where *m32fp* is a REAL4 memory operand, *m64fp* is a REAL8 operand, and *i* is a register number:

```
FADD4
FADD m32fp
FADD m64fp
FADD ST(0), ST(i)
FADD ST(i), ST(0)
```

**No Operands** If no operands are used with FADD, ST(0) is added to ST(1). The result is temporarily stored in ST(1). ST(0) is then popped from the stack, leaving the result on the top of the stack. The following figure demonstrates FADD, assuming that the stack already contains two values:

|        |         |       |        |
|--------|---------|-------|--------|
| fadd   | Before: | ST(1) | 234.56 |
|        |         | ST(0) | 10.1   |
| After: |         |       |        |
|        |         | ST(0) | 244.66 |

**Register Operands** Starting with the same stack contents, the following illustration demonstrates adding ST(0) to ST(1):

|                   |         |       |        |
|-------------------|---------|-------|--------|
| fadd st(1), st(0) | Before: | ST(1) | 234.56 |
|                   |         | ST(0) | 10.1   |
| After:            |         |       |        |
|                   |         | ST(1) | 244.66 |
|                   |         | ST(0) | 10.1   |

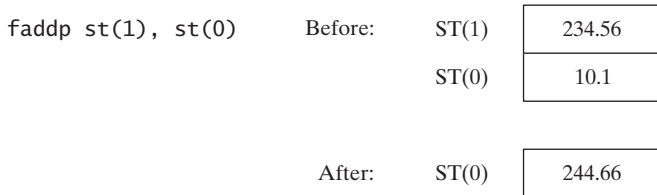
**Memory Operand** When used with a memory operand, FADD adds the operand to ST(0). Here are examples:

```
fadd mySingle           ; ST(0) += mySingle
fadd REAL8 PTR[esi]    ; ST(0) += [esi]
```

**FADDP** The FADDP (add with pop) instruction pops ST(0) from the stack after performing the addition operation. MASM supports the following format:

```
FADDP ST(i),ST(0)
```

The following figure shows how FADDP works:



**FIADD** The FIADD (add integer) instruction converts the source operand to double extended-precision floating-point format before adding the operand to ST(0). It has the following syntax:

```
FIADD m16int
FIADD m32int
```

Example:

```
.data
myInteger DWORD 1
.code
fiadd myInteger ; ST(0) += myInteger
```

### **FSUB, FSUBP, FISUB**

The FSUB instruction subtracts a source operand from a destination operand, storing the difference in the destination operand. The destination is always an FPU register, and the source can be either an FPU register or memory. It accepts the same operands as FADD:

```
FSUB5
FSUB m32fp
FSUB m64fp
FSUB ST(0), ST(i)
FSUB ST(i), ST(0)
```

FSUB's operation is similar to that of FADD, except that it subtracts rather than adds. For example, the no-operand form of FSUB subtracts ST(0) from ST(1). The result is temporarily stored in ST(1). ST(0) is then popped from the stack, leaving the result on the top of the stack. FSUB with a memory operand subtracts the memory operand from ST(0) and does not pop the stack.

Examples:

```
fsub mySingle ; ST(0) -= mySingle
fsub array[edi*8] ; ST(0) -= array[edi*8]
```

**FSUBP** The FSUBP (subtract with pop) instruction pops ST(0) from the stack after performing the subtraction. MASM supports the following format:

```
FSUBP ST(i),ST(0)
```

**FISUB** The FISUB (subtract integer) instruction converts the source operand to double extended-precision floating-point format before subtracting the operand from ST(0):

```
FISUB m16int
FISUB m32int
```

### **FMUL, FMULP, FIMUL**

The FMUL instruction multiplies a source operand by a destination operand, storing the product in the destination operand. The destination is always an FPU register, and the source can be a register or memory operand. It uses the same syntax as FADD and FSUB:

```
FMUL6
FMUL m32fp
FMUL m64fp
FMUL ST(0), ST(i)
FMUL ST(i), ST(0)
```

FMUL's operation is similar to that of FADD, except it multiplies rather than adds. For example, the no-operand form of FMUL multiplies ST(0) by ST(1). The product is temporarily stored in ST(1). ST(0) is then popped from the stack, leaving the product on the top of the stack. Similarly, FMUL with a memory operand multiplies ST(0) by the memory operand:

```
fmul mySingle ; ST(0) *= mySingle
```

**FMULP** The FMULP (multiply with pop) instruction pops ST(0) from the stack after performing the multiplication. MASM supports the following format:

```
FMULP ST(i), ST(0)
```

**FIMUL** is identical to FIADD, except that it multiplies rather than adds:

```
FIMUL m16int
FIMUL m32int
```

### **FDIV, FDIVP, FIDIV**

The FDIV instruction divides a destination operand by a source operand, storing the dividend in the destination operand. The destination is always a register, and the source operand can be either a register or memory. It has the same syntax as FADD and FSUB:

```
FDIV7
FDIV m32fp
FDIV m64fp
FDIV ST(0), ST(i)
FDIV ST(i), ST(0)
```

FDIV's operation is similar to that of FADD, except that it divides rather than adds. For example, the no-operand form of FDIV divides ST(1) by ST(0). ST(0) is popped from the stack, leaving the dividend on the top of the stack. FDIV with a memory operand divides ST(0) by the memory operand. The following code divides **dblOne** by **dblTwo** and stores the quotient in **dblQuot**:

```
.data
dblOne REAL8 1234.56
```

```

dblTwo    REAL8    10.0
dblQuot   REAL8    ?
.code
fld  dblOne                ; load into ST(0)
fdiv dblTwo                ; divide ST(0) by dblTwo
fstp dblQuot              ; store ST(0) to dblQuot

```

If the source operand is zero, a divide-by-zero exception is generated. A number of special cases apply when operands equal to positive or negative infinity, zero, and *NaN* are divided. For details, see the Intel Instruction Set Reference manual.

**FIDIV** The FIDIV instruction converts an integer source operand to double extended-precision floating-point format before dividing it into ST(0). Syntax:

```

FIDIV  m16int
FIDIV  m32int

```

### 12.2.6 Comparing Floating-Point Values

Floating-point values cannot be compared using the CMP instruction—the latter uses integer subtraction to perform comparisons. Instead, the FCOM instruction must be used. After executing FCOM, special steps must be taken before using conditional jump instructions (JA, JB, JE, etc.) in logical IF statements. Since all floating-point values are implicitly signed, FCOM performs a signed comparison.

**FCOM, FCOMP, FCOMPP** The FCOM (compare floating-point values) instruction compares ST(0) to its source operand. The source can be a memory operand or FPU register. Syntax:

| Instruction         | Description                     |
|---------------------|---------------------------------|
| FCOM                | Compare ST(0) to ST(1)          |
| FCOM <i>m32fp</i>   | Compare ST(0) to <i>m32fp</i>   |
| FCOM <i>m64fp</i>   | Compare ST(0) to <i>m64fp</i>   |
| FCOM ST( <i>i</i> ) | Compare ST(0) to ST( <i>i</i> ) |

The FCOMP instruction carries out the same operations with the same types of operands, and ends by popping ST(0) from the stack. The FCOMPP instruction is the same as that of FCOMP, except it pops the stack one more time.

**Condition Codes** Three FPU condition code flags, C3, C2, and C0, indicate the results of comparing floating-point values (Table 12-13). The column headings show equivalent CPU status flags because C3, C2, and C0 are similar in function to the Zero, Parity, and Carry flags, respectively.

TABLE 12-13 Condition Codes Set by FCOM, FCOMP, FCOMPP.

| Condition              | C3<br>(Zero Flag) | C2<br>(Parity Flag) | C0<br>(Carry Flag) | Conditional Jump<br>to Use |
|------------------------|-------------------|---------------------|--------------------|----------------------------|
| ST(0) > SRC            | 0                 | 0                   | 0                  | JA, JNBE                   |
| ST(0) < SRC            | 0                 | 0                   | 1                  | JB, JNAE                   |
| ST(0) = SRC            | 1                 | 0                   | 0                  | JE, JZ                     |
| Unordered <sup>a</sup> | 1                 | 1                   | 1                  | (None)                     |

<sup>a</sup>If an invalid arithmetic operand exception is raised (because of invalid operands) and the exception is masked, C3, C2, and C0 are set according to the row marked *Unordered*.

The primary challenge after comparing two values and setting FPU condition codes is to find a way to branch to a label based on the conditions. Two steps are involved:

- Use the FNSTSW instruction to move the FPU status word into AX.
- Use the SAHF instruction to copy AH into the EFLAGS register.

Once the condition codes are in EFLAGS, you can use conditional jumps based on the Zero, Parity, and Carry flags. Table 12-13 showed the appropriate conditional jump for each combination of flags. We can infer additional jumps: The JAE instruction causes a transfer of control if CF = 0. JBE causes a transfer of control if CF = 1 or ZF = 1. JNE transfers if ZF = 0.

**Example** Start with the following C++ code:

```
double X = 1.2;
double Y = 3.0;
int N = 0;
if( X < Y )
    N = 1;
```

The following assembly language code is equivalent:

```
.data
X REAL8 1.2
Y REAL8 3.0
N DWORD 0
.code
; if( X < Y )
;   N = 1
    fld     X                ; ST(0) = X
    fcomp  Y                ; compare ST(0) to Y
    fnstsw ax               ; move status word into AX
    sahf                    ; copy AH into EFLAGS
    jnb    L1               ; X not < Y? skip
    mov    N,1              ; N = 1
L1:
```

**P6 Processor Improvements** One point to be made about the foregoing example is that floating-point comparisons incur more runtime overhead than integer comparisons. With this in mind, Intel's P6 family introduced the FCOMI instruction. It compares floating-point values and

sets the Zero, Parity, and Carry flags directly. (The P6 family started with the Pentium Pro and Pentium II processors.) FCOMI has the following syntax:

```
FCOMI ST(0),ST(i)
```

Let's rewrite our previous code example (comparing X and Y) using FCOMI:

```
.code
; if( X < Y )
;   N = 1
    fld   Y                ; ST(0) = Y
    fld   X                ; ST(0) = X, ST(1) = Y
    fcomi ST(0),ST(1)     ; compare ST(0) to ST(1)
    jnb   L1              ; ST(0) not < ST(1)? skip
    mov   N,1            ; N = 1
L1:
```

The FCOMI instruction took the place of three instructions in the previous version, but required one more FLD. The FCOMI instruction does not accept memory operands.

### Comparing for Equality

Almost every beginning programming textbook warns readers not to compare floating-point values for equality because of rounding errors that occur during calculations. We can demonstrate the problem by calculating the following expression:  $(\text{sqrt}(2.0) * \text{sqrt}(2.0)) - 2.0$ . Mathematically, it should equal zero, but the results are quite different (approximately  $4.4408921\text{E}-016$ ). We will use the following data, and show the FPU stack after every step in Table 12-14:

```
val1 REAL8 2.0
```

TABLE 12-14 Calculating  $(\text{sqrt}(2.0) * \text{sqrt}(2.0)) - 2.0$ .

| Instruction      | FPU Stack              |
|------------------|------------------------|
| fld val1         | ST(0): +2.0000000E+000 |
| fsqrt            | ST(0): +1.4142135E+000 |
| fmul ST(0),ST(0) | ST(0): +2.0000000E+000 |
| fsub val1        | ST(0): +4.4408921E-016 |

The proper way to compare floating-point values  $x$  and  $y$  is to take the absolute value of their difference,  $|x - y|$ , and compare it to a small user-defined value called *epsilon*. Here's code in assembly language that does it, using *epsilon* as the maximum difference they can have and still be considered equal:

```
.data
epsilon REAL8 1.0E-12
val2 REAL8 0.0                ; value to compare
val3 REAL8 1.001E-13         ; considered equal to val2

.code
; if( val2 == val3 ), display "Values are equal".
    fld   epsilon
    fld   val2
```

```

    fsub  val3
    fabs
    fcomi ST(0),ST(1)
    ja    skip
    mWrite <"Values are equal",0dh,0ah>
skip:

```

Table 12-15 tracks the program's progress, showing the stack after each of the first four instructions execute.

TABLE 12-15 Calculating a Dot Product  $(6.0 * 2.0) + (4.5 * 3.2)$ .

| Instruction       | FPU Stack                                        |
|-------------------|--------------------------------------------------|
| fld epsilon       | ST(0): +1.0000000E-012                           |
| fld val2          | ST(0): +0.0000000E+000<br>ST(1): +1.0000000E-012 |
| fsub val3         | ST(0): -1.0010000E-013<br>ST(1): +1.0000000E-012 |
| fabs              | ST(0): +1.0010000E-013<br>ST(1): +1.0000000E-012 |
| fcomi ST(0),ST(1) | ST(0) < ST(1), so CF=1, ZF=0                     |

If we redefined val3 as being larger than epsilon, it would not be equal to val2:

```
val3 REAL8 1.001E-12          ; not equal
```

### 12.2.7 Reading and Writing Floating-Point Values

Included in the book's link libraries are two procedures for floating-point input-output, created by William Barrett of San Jose State University:

- **ReadFloat:** Reads a floating-point value from the keyboard and pushes it on the floating-point stack.
- **WriteFloat:** Writes the floating-point value at ST(0) to the console window in exponential format.

ReadFloat accepts a wide variety of floating-point formats. Here are examples:

```

35
+35.
-3.5
.35
3.5E5
3.5E005
-3.5E+5
3.5E-4
+3.5E-4

```

*ShowFPUStack* Another useful procedure, written by James Brink of Pacific Lutheran University, displays the FPU stack. Call it with no parameters:

```
call ShowFPUStack
```



**Example Program** The following example program pushes two floating-point values on the FPU stack, displays it, inputs two values from the user, multiplies them, and displays their product:

```

; 32-bit Floating-Point I/O Test (floatTest32.asm)

INCLUDE Irvine32.inc
INCLUDE macros.inc

.data
first REAL8 123.456
second REAL8 10.0
third REAL8 ?

.code
main PROC
    finit                ; initialize FPU

; Push two floats and display the FPU stack.
    fld first
    fld second
    call ShowFPUStack

; Input two floats and display their product.
    mWrite "Please enter a real number: "
    call ReadFloat

    mWrite "Please enter a real number: "
    call ReadFloat

    fmul ST(0),ST(1)    ; multiply

    mWrite "Their product is: "
    call WriteFloat
    call Crlf

    exit
main ENDP
END main

```

Sample input/output (user input shown in bold type):

```

----- FPU Stack -----
ST(0): +1.0000000E+001
ST(1): +1.2345600E+002
Please enter a real number: 3.5
Please enter a real number: 4.2
Their product is: +1.4700000E+001

```

### 12.2.8 Exception Synchronization

The integer (CPU) and FPU are separate units, so floating-point instructions can execute at the same time as integer and system instructions. This capability, named *concurrency*, can be a potential problem when unmasked floating-point exceptions occur. Masked exceptions, on the

other hand, are not a problem because the FPU always completes the current operation and stores the result.

When an unmasked exception occurs, the current floating-point instruction is interrupted and the FPU signals the exception event. When the next floating-point instruction or the FWAIT (WAIT) instruction is about to execute, the FPU checks for pending exceptions. If any are found, it invokes the floating-point exception handler (a subroutine).

What if the floating-point instruction causing the exception is followed by an integer or system instruction? Unfortunately, such instructions do not check for pending exceptions—they execute immediately. If the first instruction is supposed to store its output in a memory operand and the second instruction modifies the same memory operand, the exception handler cannot execute properly. Here's an example:

```
.data
intVal DWORD 25
.code
fld intVal           ; load integer into ST(0)
inc intVal          ; increment the integer
```

The WAIT and FWAIT instructions were created to force the processor to check for pending, unmasked floating-point exceptions before proceeding to the next instruction. Either one solves our potential synchronization problem, preventing the INC instruction from executing until the exception handler has a chance to finish:

```
fld intVal           ; load integer into ST(0)
fwait               ; wait for pending exceptions
inc intVal          ; increment the integer
```

### 12.2.9 Code Examples

In this section, we look at a few short examples that demonstrate floating-point arithmetic instructions. An excellent way to learn is to code expressions in C++, compile them, and inspect the code produced by the compiler.

#### **Expression**

Let's code the expression  $valD = -valA + (valB * valC)$ . A possible step-by-step solution is: Load *valA* on the stack and negate it. Load *valB* into ST(0), moving *valA* down to ST(1). Multiply ST(0) by *valC*, leaving the product in ST(0). Add ST(1) and ST(0) and store the sum in *valD*:

```
.data
valA REAL8 1.5
valB REAL8 2.5
valC REAL8 3.0
valD REAL8 ?; +6.0
.code
fld valA           ; ST(0) = valA
fchs              ; change sign of ST(0)
fld valB          ; load valB into ST(0)
fmul valC         ; ST(0) *= valC
```

```

fadd                ; ST(0) += ST(1)
fstp valD           ; store ST(0) to valD

```

### Sum of an Array

The following code calculates and displays the sum of an array of double-precision reals:

```

ARRAY_SIZE = 20
.data
sngArray REAL8 ARRAY_SIZE DUP(?)
.code
    mov     esi,0           ; array index
    fldz                   ; push 0.0 on stack
    mov     ecx,ARRAY_SIZE
L1: fld     sngArray[esi]   ; load mem into ST(0)
    fadd                   ; add ST(0), ST(1), pop
    add     esi,TYPE REAL8 ; move to next element
    loop   L1
    call   WriteFloat      ; display the sum in ST(0)

```

### Sum of Square Roots

The FSQRT instruction replaces the number in ST(0) with its square root. The following code calculates the sum of two square roots:

```

.data
valA REAL8 25.0
valB REAL8 36.0
.code
fld valA           ; push valA
fsqrt              ; ST(0) = sqrt(valA)
fld valB           ; push valB
fsqrt              ; ST(0) = sqrt(valB)
fadd               ; add ST(0), ST(1)

```

### Array Dot Product

The following code calculates the expression  $(array[0] * array[1]) + (array[2] * array[3])$ . The calculation is sometimes referred to as a *dot product*. Table 12-16 displays the FPU stack after each instruction executes. Here is the input data:

```

.data
array REAL4 6.0, 2.0, 4.5, 3.2

```

TABLE 12-16 Calculating a Dot Product  $(6.0 * 2.0) + (4.5 * 3.2)$ .

| Instruction     | FPU Stack              |
|-----------------|------------------------|
| fld array       | ST(0): +6.0000000E+000 |
| fmul [array+4]  | ST(0): +1.2000000E+001 |
| fld [array+8]   | ST(0): +4.5000000E+000 |
|                 | ST(1): +1.2000000E+001 |
| fmul [array+12] | ST(0): +1.4400000E+001 |
|                 | ST(1): +1.2000000E+001 |
| fadd            | ST(0): +2.6400000E+001 |

### 12.2.10 Mixed-Mode Arithmetic

Up to this point, we have performed arithmetic operations involving only reals. Applications often perform mixed-mode arithmetic, combining integers and reals. Integer arithmetic instructions such as ADD and MUL cannot handle reals, so our only choice is to use floating-point instructions. The Intel instruction set provides instructions that promote integers to reals and load the values onto the floating-point stack.

*Example* The following C++ code adds an integer to a double and stores the sum in a double. C++ automatically promotes the integer to a real before performing the addition:

```
int N = 20;
double X = 3.5;
double Z = N + X;
```

Here is the equivalent assembly language:

```
.data
N SDWORD 20
X REAL8 3.5
Z REAL8 ?
.code
fild N           ; load integer into ST(0)
fadd X           ; add mem to ST(0)
fstp Z          ; store ST(0) to mem
```

*Example* The following C++ program promotes N to a double, evaluates a real expression, and stores the result in an integer variable:

```
int N = 20;
double X = 3.5;
int Z = (int) (N + X);
```

The code generated by Visual C++ calls a conversion function (ftol) before storing the truncated result in Z. If we code the expression in assembly language using FIST, we can avoid the function call, but Z is (by default) rounded upward to 24:

```
fild N           ; load integer into ST(0)
fadd X           ; add mem to ST(0)
fist Z          ; store ST(0) to mem int
```

*Changing the Rounding Mode* The RC field of the FPU control word lets you specify the type of rounding to be performed. We can use FSTCW to store the control word in a variable, modify the RC field (bits 10 and 11), and use the FLDCW instruction to load the variable back into the control word:

```
fstcw ctrlWord   ; store control word
or   ctrlWord,110000000000b ; set RC = truncate
fldcw ctrlWord   ; load control word
```

Then we perform calculations requiring truncation, producing  $Z = 23$ :

```
fild N           ; load integer into ST(0)
fadd X           ; add mem to ST(0)
fist Z          ; store ST(0) to mem int
```

Optionally, we reset the rounding mode to its default (*round to nearest even*):

```
fstcw  ctrlWord          ; store control word
and    ctrlWord,001111111111b ; reset rounding to default
fldcw  ctrlWord          ; load control word
```

### 12.2.11 Masking and Unmasking Exceptions

Exceptions are masked by default (Section 12.2.3), so when a floating-point exception is generated, the processor assigns a default value to the result and continues quietly on its way. For example, dividing a floating-point number by zero produces infinity without halting the program:

```
.data
val1  DWORD 1
val2  REAL8 0.0
.code
fild  val1          ; load integer into ST(0)
fdiv  val2          ; ST(0) = positive infinity
```

If you unmask the exception in the FPU control word, the processor tries to execute an appropriate exception handler. Unmasking is accomplished by clearing the appropriate bit in the FPU control word (Table 12-17). Suppose we want to unmask the divide by Zero exception. Here are the required steps:

1. Store the FPU control word in a 16-bit variable.
2. Clear bit 2 (divide by zero flag).
3. Load the variable back into the control word.

TABLE 12-17 Fields in the FPU Control Word.

| Bit(s) | Description                      |
|--------|----------------------------------|
| 0      | Invalid operation exception mask |
| 1      | Denormal operand exception mask  |
| 2      | Divide by zero exception mask    |
| 3      | Overflow exception mask          |
| 4      | Underflow exception mask         |
| 5      | Precision exception mask         |
| 8–9    | Precision control                |
| 10–11  | Rounding control                 |
| 12     | Infinity control                 |

The following code unmask floating-point exceptions:

```
.data
ctrlWord WORD ?
.code
fstcw  ctrlWord          ; get the control word
```

```
and    ctrlWord,111111111111011b; unmask divide by zero
fldcw  ctrlWord                  ; load it back into FPU
```

Now, if we execute code that divides by zero, an unmasked exception is generated:

```
fld  val1
fdiv val2                ; divide by zero
fst  val2
```

As soon as the FST instruction begins to execute, MS-Windows displays the following dialog:



**Masking Exceptions** To mask an exception, set the appropriate bit in the FPU control word. The following code masks divide by zero exceptions:

```
.data
ctrlWord WORD ?
.code
fstcw  ctrlWord          ; get the control word
or     ctrlWord,100b     ; mask divide by zero
fldcw  ctrlWord          ; load it back into FPU
```

### 12.2.12 Section Review

1. Write an instruction that loads a duplicate of ST(0) onto the FPU stack.
2. If ST(0) is positioned at absolute register R6 in the register stack, what is the position of ST(2)?
3. Name at least three FPU special-purpose registers.
4. When the second letter of a floating-point instruction is B, what type of operand is indicated?
5. Which floating-point instructions accept immediate operands?

## 12.3 x86 Instruction Encoding

To fully understand assembly language operation codes and operands, you need to spend some time looking at the way assembly instructions are translated into machine language. The topic is quite complex because of the rich variety of instructions and addressing modes available in the Intel instruction set. We will begin with the 8086/8088 processor as an illustrative example, running in real-address mode. Later, we will show some of the changes made when Intel introduced 32-bit processors.

The Intel 8086 processor was the first in a line of processors using a *Complex Instruction Set Computer* (CISC) design. The instruction set includes a wide variety of memory-addressing, shifting, arithmetic, data movement, and logical operations. Compared to RISC (*Reduced*

*Instruction Set Computer*) instructions, Intel instructions are somewhat tricky to encode and decode. To *encode* an instruction means to convert an assembly language instruction and its operands into machine code. To *decode* an instruction means to convert a machine code instruction into assembly language. If nothing else, our walk-through of the encoding and decoding of Intel instructions will help to give you an appreciation for the hard work done by MASM's authors.

### 12.3.1 Instruction Format

The general x86 machine instruction format (Fig. 12-6) contains an instruction prefix byte, opcode, Mod R/M byte, scale index byte (SIB), address displacement, and immediate data. Instructions are stored in little-endian order, so the prefix byte is located at the instruction's starting address. Every instruction has an opcode, but the remaining fields are optional. Few instructions contain all fields; on average, most instructions are 2 or 3 bytes. Here is a quick summary of the fields:

- The **instruction prefix** overrides default operand sizes.
- The **opcode** (operation code) identifies a specific variant of an instruction. The ADD instruction, for example, has nine different opcodes, depending on the parameter types used.
- The **Mod R/M** field identifies the addressing mode and operands. The notation "R/M" stands for *register* and *mode*. Table 12-18 describes the Mod field, and Table 12-19 describes the R/M field for 16-bit applications when Mod = 10 binary.
- The **scale index byte** (SIB) is used to calculate offsets of array indexes.
- The **address displacement** field holds an operand's offset, or it can be added to base and index registers in addressing modes such as base-displacement or base-index-displacement.
- The **immediate data** field holds constant operands.

FIGURE 12-6 x86 Instruction Format.

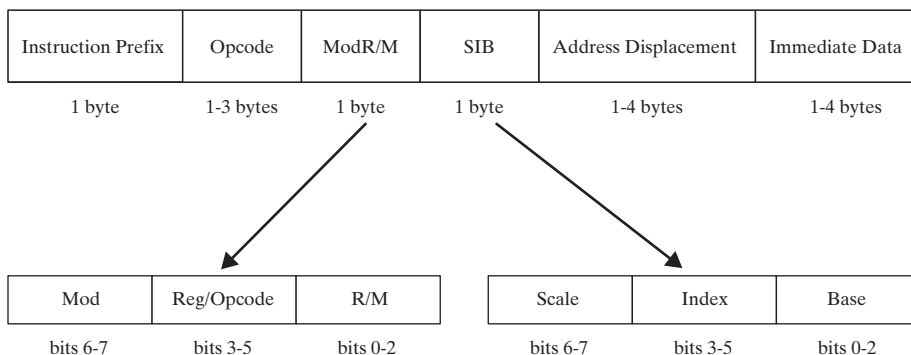


TABLE 12-18 Mod Field Values.

| Mod | Displacement                                                    |
|-----|-----------------------------------------------------------------|
| 00  | DISP = 0, disp-low and disp-high are absent (unless r/m = 110). |
| 01  | DISP = disp-low sign-extended to 16 bits; disp-high is absent.  |
| 10  | DISP = disp-high and disp-low are used.                         |
| 11  | R/M field contains a register number.                           |

TABLE 12-19 16-Bit R/M Field Values  
(for Mod = 10).

| R/M | Effective Address              |
|-----|--------------------------------|
| 000 | [ BX + SI ] + D16 <sup>a</sup> |
| 001 | [ BX + DI ] + D16              |
| 010 | [ BP + SI ] + D16              |
| 011 | [ BP + DI ] + D16              |
| 100 | [ SI ] + D16                   |
| 101 | [ DI ] + D16                   |
| 110 | [ BP ] + D16                   |
| 111 | [ BX ] + D16                   |

<sup>a</sup>D16 indicates a 16-bit displacement.

### 12.3.2 Single-Byte Instructions

The simplest type of instruction is one with either no operand or an implied operand. Such instructions require only the opcode field, the value of which is predetermined by the processor's instruction set. Table 12-20 lists a few common single-byte instructions. It might appear that the INC DX instruction slipped into the table by mistake, but the designers of the instruction set decided to supply unique opcodes for certain commonly used instructions. As a consequence, register increments are optimized for code size and execution speed.

TABLE 12-20 Single-Byte  
Instructions.

| Instruction | Opcode |
|-------------|--------|
| AAA         | 37     |
| AAS         | 3F     |
| CBW         | 98     |
| LODSB       | AC     |
| XLAT        | D7     |
| INC DX      | 42     |

### 12.3.3 Move Immediate to Register

Immediate operands (constants) are appended to instructions in little-endian order (lowest byte first). We will focus first on instructions that move immediate values to registers, avoiding the complications of memory-addressing modes for the moment. The encoding format of a MOV instruction that moves an immediate word into a register is **B8 + rw dw**, where the opcode byte value is **B8 + rw**, indicating that a register number (0 through 7) is added to B8; *dw* is the immediate word operand, low byte first. (Register numbers used in opcodes are listed in Table 12-21.) All numeric values in the following examples are hexadecimal.



*Example: PUSH CX* The machine instruction is **51**. The encoding steps are as follows:

1. The opcode for PUSH with a 16-bit register operand is **50**.
2. The register number for CX is 1, so add 1 to 50, producing opcode **51**.

TABLE 12-21 Register Numbers (8/16 bit).

| Register | Code |
|----------|------|
| AX/AL    | 0    |
| CX/CL    | 1    |
| DX/DL    | 2    |
| BX/BL    | 3    |
| SP/AH    | 4    |
| BP/CH    | 5    |
| SI/DH    | 6    |
| DI/BH    | 7    |

*Example: MOV AX, 1* The machine instruction is **B8 01 00** (hexadecimal). Here's how it is encoded:

1. The opcode for moving an immediate value to a 16-bit register is **B8**.
2. The register number for AX is 0, so 0 is added to B8 (refer to Table 12-21).
3. The immediate operand (0001) is appended to the instruction in little-endian order (01, 00).

*Example: MOV BX, 1234h* The machine instruction is **BB 34 12**. The encoding steps are as follows:

1. The opcode for moving an immediate value to a 16-bit register is **B8**.
2. The register number for BX is 3, so add 3 to B8, producing opcode **BB**.
3. The immediate operand bytes are **34 12**.

For practice, we suggest you hand-assemble a few MOV immediate instructions to improve your skills, and then check your results by inspecting the code generated by MASM in a source listing file.

### 12.3.4 Register-Mode Instructions

In instructions using register operands, the Mod R/M byte contains a 3-bit identifier for each register operand. Table 12-22 lists the bit encodings for registers. The choice of 8-bit or 16-bit register depends on bit 0 of the opcode field: 1 indicates a 16-bit register, and 0 indicates an 8-bit register.

TABLE 12-22 Identifying Registers in the Mod R/M Field.

| R/M | Register | R/M | Register |
|-----|----------|-----|----------|
| 000 | AX or AL | 100 | SP or AH |
| 001 | CX or CL | 101 | BP or CH |
| 010 | DX or DL | 110 | SI or DH |
| 011 | BX or BL | 111 | DI or BH |

For example, the machine language for **MOV AX, BX** is **89 D8**. The Intel encoding of a 16-bit MOV from a register to any other operand is **89/r**, where /r indicates that a Mod R/M byte fol-

lows the opcode. The Mod R/M byte is made up of three fields (*mod*, *reg*, and *r/m*). A Mod R/M value of D8, for example, contains the following fields:

| mod | reg | r/m |
|-----|-----|-----|
| 11  | 011 | 000 |

- Bits 6 to 7 are the *mod* field, which identifies the addressing mode. The *mod* field is 11, indicating that the *r/m* field contains a register number.
- Bits 3 to 5 are the *reg* field, which identifies the source operand. In our example, BX is register 011.
- Bits 0 to 2 are the *r/m* field, which identifies the destination operand. In our example, AX is register 000.

Table 12-23 lists a few more examples that use 8-bit and 16-bit register operands.

TABLE 12-23 Sample MOV Instruction Encodings, Register Operands.

| Instruction | Opcode | mod | reg | r/m |
|-------------|--------|-----|-----|-----|
| mov ax,dx   | 8B     | 11  | 000 | 010 |
| mov al,dl   | 8A     | 11  | 000 | 010 |
| mov cx,dx   | 8B     | 11  | 001 | 010 |
| mov cl,dl   | 8A     | 11  | 001 | 010 |

### 12.3.5 Processor Operand-Size Prefix

Let us now turn our attention to instruction encoding for x86 processors (IA-32). Some instructions begin with an operand-size prefix (66h) that overrides the default segment attribute for the instruction it modifies. The question is, why have an instruction prefix? When the 8088/8086 instruction set was created, almost all 256 possible opcodes were used to handle instructions using 8- and 16-bit operands. When Intel introduced 32-bit processors, they had to find a way to invent new opcodes to handle 32-bit operands, yet retain compatibility with older processors. For programs targeting 16-bit processors, they added a prefix byte to any instruction that used 32-bit operands. For programs targeting 32-bit processors, 32-bit operands were the default, so a prefix byte was added to any instruction using 16-bit operands. Eight-bit operands need no prefix.

**Example: 16-Bit Operands** We can see how prefix bytes work in 16-bit mode by assembling the MOV instructions listed earlier in Table 12-23. The `.286` directive indicates the target processor for the compiled code, assuring (for one thing) that no 32-bit registers are used. Alongside each MOV instruction, we show its instruction encoding:

```
.model small
.286
.stack 100h
.code
main PROC
    mov  ax,dx          ; 8B C2
    mov  al,dl         ; 8A C2
```

Let's assemble the same instructions for a 32-bit processor, using the `.386` directive; the default operand size is 32 bits. We will include both 16-bit and 32-bit operands. The first `MOV` instruction (`EAX, EDX`) needs no prefix because it uses 32-bit operands. The second `MOV` (`AX, DX`) requires an operand-size prefix (`66`) because it uses 16-bit operands:

```
.model small
.386
.stack 100h
.code
main PROC
    mov  eax,edx           ; 8B C2
    mov  ax,dx            ; 66 8B C2
    mov  al,dl            ; 8A C2
```

### 12.3.6 Memory-Mode Instructions

If the Mod R/M byte were only used for identifying register operands, Intel instruction encoding would be relatively simple. In fact, Intel assembly language has a wide variety of memory-addressing modes, causing the encoding of the Mod R/M byte to be fairly complex. (The instruction set's complexity is a common source of criticism by proponents of reduced instruction set computer designs.)

Exactly 256 different combinations of operands can be specified by the Mod R/M byte. Table 12-24 lists the Mod R/M bytes (in hexadecimal) for Mod 00. (The complete table can be found in the *Intel 64 and IA-32 Architectures Software Developer's Manual*, Vol. 2A.) Here's how the encoding of Mod R/M bytes works: The two bits in the **Mod** column indicate groups of addressing modes. Mod 00, for example, has eight possible **R/M** values (000 to 111 binary) that identify operand types listed in the **Effective Address** column.

Suppose we want to encode `MOV AX,[SI]`; the Mod bits are 00, and the R/M bits are 100 binary. We know from Table 12-19 that `AX` is register number 000 binary, so the complete Mod R/M byte is 00 000 100 binary or 04 hexadecimal:

| mod | reg | r/m |
|-----|-----|-----|
| 00  | 000 | 100 |

The hexadecimal byte 04 appears in the column marked `AX`, in row 5 of Table 12-24.

The Mod R/M byte for `MOV [SI],AL` is the same (04h) because register `AL` is also register number 000. Let's encode the instruction `MOV [SI],AL`. The opcode for a move from an 8-bit register is **88**. The Mod R/M byte is 04h, and the machine instruction is **88 04**.

### *MOV* Instruction Examples

All the instruction formats and opcodes for 8-bit and 16-bit `MOV` instructions are shown in Table 12-25. Tables 12-26 and 12-27 provide supplemental information about abbreviations used in Table 12-25. Use these tables as references when hand-assembling `MOV` instructions. (For more details, refer to the Intel manuals.)

Table 12-24 Partial List of Mod R/M Bytes (16-Bit Segments).

| Byte:        |     | AL            | CL  | DL  | BL  | AH  | CH  | DH  | BH  |                     |
|--------------|-----|---------------|-----|-----|-----|-----|-----|-----|-----|---------------------|
| Word:        |     | AX            | CX  | DX  | BX  | SP  | BP  | SI  | DI  |                     |
| Register ID: |     | 000           | 001 | 010 | 011 | 100 | 101 | 110 | 111 |                     |
| Mod          | R/M | Mod R/M Value |     |     |     |     |     |     |     | Effective Address   |
| 00           | 000 | 00            | 08  | 10  | 18  | 20  | 28  | 30  | 38  | [ BX + SI ]         |
|              | 001 | 01            | 09  | 11  | 19  | 21  | 29  | 31  | 39  | [ BX + DI ]         |
|              | 010 | 02            | 0A  | 12  | 1A  | 22  | 2A  | 32  | 3A  | [ BP + SI ]         |
|              | 011 | 03            | 0B  | 13  | 1B  | 23  | 2B  | 33  | 3B  | [ BP + DI ]         |
|              | 100 | 04            | 0C  | 14  | 1C  | 24  | 2C  | 34  | 3C  | [ SI ]              |
|              | 101 | 05            | 0D  | 15  | 1D  | 25  | 2D  | 35  | 3D  | [ DI ]              |
|              | 110 | 06            | 0E  | 16  | 1E  | 26  | 2E  | 36  | 3E  | 16-bit displacement |
|              | 111 | 07            | 0F  | 17  | 1F  | 27  | 2F  | 37  | 3F  | [ BX ]              |

Table 12-25 MOV Instruction Opcodes.

| Opcode | Instruction | Description                            |
|--------|-------------|----------------------------------------|
| 88/r   | MOV eb,rb   | Move byte register into EA byte        |
| 89/r   | MOV ew,rw   | Move word register into EA word        |
| 8A/r   | MOV rb,eb   | Move EA byte into byte register        |
| 8B/r   | MOV rw,ew   | Move EA word into word register        |
| 8C/0   | MOV ew,ES   | Move ES into EA word                   |
| 8C/1   | MOV ew,CS   | Move CS into EA word                   |
| 8C/2   | MOV ew,SS   | Move SS into EA word                   |
| 8C/3   | MOV ew,DS   | Move DS into EA word                   |
| 8E/0   | MOV ES,mw   | Move memory word into ES               |
| 8E/0   | MOV ES,rw   | Move word register into ES             |
| 8E/2   | MOV SS,mw   | Move memory word into SS               |
| 8E/2   | MOV SS,rw   | Move register word into SS             |
| 8E/3   | MOV DS,mw   | Move memory word into DS               |
| 8E/3   | MOV DS,rw   | Move word register into DS             |
| A0 dw  | MOV AL,xb   | Move byte variable (offset dw) into AL |
| A1 dw  | MOV AX,xw   | Move word variable (offset dw) into AX |
| A2 dw  | MOV xb,AL   | Move AL into byte variable (offset dw) |

Table 12-25 (Continued)

| Opcode    | Instruction | Description                            |
|-----------|-------------|----------------------------------------|
| A3 dw     | MOV xw,AX   | Move AX into word register (offset dw) |
| B0 +rb db | MOV rb,db   | Move immediate byte into byte register |
| B8 +rw dw | MOV rw,dw   | Move immediate word into word register |
| C6 /0 db  | MOV eb,db   | Move immediate byte into EA byte       |
| C7 /0 dw  | MOV ew,dw   | Move immediate word into EA word       |

Table 12-26 Key to Instruction Opcodes.

|      |                                                                                                                                                                 |
|------|-----------------------------------------------------------------------------------------------------------------------------------------------------------------|
| /n:  | A Mod R/M byte follows the opcode, possibly followed by immediate and displacement fields. The digit n (0–7) is the value of the reg field of the Mod R/M byte. |
| /r:  | A Mod R/M byte follows the opcode, possibly followed by immediate and displacement fields.                                                                      |
| db:  | An immediate byte operand follows the opcode and Mod R/M bytes.                                                                                                 |
| dw:  | An immediate word operand follows the opcode and Mod R/M bytes.                                                                                                 |
| +rb: | A register code (0–7) for an 8-bit register, which is added to the preceding hexadecimal byte to form an 8-bit opcode.                                          |
| +rw: | A register code (0–7) for a 16-bit register, which is added to the preceding hexadecimal byte to form an 8-bit opcode.                                          |

Table 12-27 Key to Instruction Operands.

|    |                                                                                                     |
|----|-----------------------------------------------------------------------------------------------------|
| db | A signed value between –128 and +127. If combined with a word operand, this value is sign-extended. |
| dw | An immediate word value that is an operand of the instruction.                                      |
| eb | A byte-sized operand, either register or memory.                                                    |
| ew | A word-sized operand, either register or memory.                                                    |
| rb | An 8-bit register identified by the value (0–7).                                                    |
| rw | A 16-bit register identified by the value (0–7).                                                    |
| xb | A simple byte memory variable without a base or index register.                                     |
| xw | A simple word memory variable without a base or index register.                                     |

Table 12-28 contains a few additional examples of MOV instructions that you can assemble by hand and compare to the machine code shown in the table. We assume that **myWord** begins at offset 0102h.

TABLE 12-28 Sample MOV Instructions, with Machine Code.

| Instruction                  | Machine Code   | Addressing Mode           |
|------------------------------|----------------|---------------------------|
| mov ax,myWord                | A1 02 01       | direct (optimized for AX) |
| mov myWord,bx                | 89 1E 02 01    | direct                    |
| mov [di],bx                  | 89 1D          | indexed                   |
| mov [bx+2],ax                | 89 47 02       | base-disp                 |
| mov [bx+si],ax               | 89 00          | base-indexed              |
| mov word ptr [bx+di+2],1234h | C7 41 02 34 12 | base-indexed-disp         |

### 12.3.7 Section Review

1. Provide opcodes for the following MOV instructions:

```
.data
myByte BYTE ?
myWord WORD ?
.code
mov ax,@data
mov ds,ax                ; a.
mov ax,bx                ; b.
mov bl,al                ; c.
mov al,[si]              ; d.
mov myByte,al            ; e.
mov myWord,ax            ; f.
```

2. Provide Mod R/M bytes for the following MOV instructions:

```
.data
array WORD 5 DUP(?)
.code
mov ax,@data
mov ds,ax                ; a.
mov dl,bl                ; b.
mov bl,[di]              ; c.
mov ax,[si+2]            ; d.
mov ax,array[si]         ; e.
mov array[di],ax         ; f.
```

## 12.4 Chapter Summary

A binary floating-point number contains three components: a sign, a significand, and an exponent. Intel processors use three floating-point binary storage formats specified in the Standard 754-1985 for Binary Floating-Point Arithmetic produced by the IEEE organization:

- A 32-bit single precision value uses 1 bit for the sign, 8 bits for the exponent, and 23 bits for the fractional part of the significand.

- A 64-bit double-precision value uses 1 bit for the sign, 11 bits for the exponent, and 52 bits for the fractional part of the significand.
- An 80-bit double extended-precision value uses 1 bit for the sign, 16 bits for the exponent, and 63 bits for the fractional part of the significand.

If the sign bit equals 1, the number is negative; if the bit is 0, the number is positive.

The significand of a floating-point number consists of the decimal digits to the left and right of the decimal point.

Not all real numbers between 0 and 1 can be represented by floating-point numbers in a computer because there are only a finite number of available bits.

Normalized finite numbers are all the nonzero finite values that can be encoded in a normalized real number between zero and infinity. Positive infinity ( $+\infty$ ) represents the maximum positive real number, and negative infinity ( $-\infty$ ) represents the maximum negative real number. *NaNs* are bit patterns that do not represent valid floating-point numbers.

The Intel 8086 processor was designed to handle only integer arithmetic, so Intel produced a separate 8087 *floating-point coprocessor* chip that was inserted on the computer's motherboard along with the 8086. With the advent of the Intel486, floating-point operations were integrated into the main CPU and renamed the *Floating-Point Unit* (FPU).

The FPU has eight individually addressable 80-bit registers, named R0 through R7, arranged in the form of a register stack. Floating-point operands are stored in the FPU stack in extended real format while being used in calculations. Memory operands are also used in calculations. When the FPU stores the result of an arithmetic operation in memory, it translates the result into one of the following formats: integer, long integer, single precision, double precision, or binary-coded decimal.

Intel floating-point instruction mnemonics begin with the letter F to distinguish them from CPU instructions. The second letter of an instruction (often B or I) indicates how a memory operand is to be interpreted: B indicates a binary-coded decimal (BCD) operand, and I indicates a binary integer operand. If neither is specified, the memory operand is assumed to be in real-number format.

The Intel 8086 processor was the first in a line of processors using a *Complex Instruction Set Computer* (CISC) design. The instruction set is large, and includes a wide variety of memory-addressing, shifting, arithmetic, data movement, and logical operations.

To *encode* an instruction means to convert an assembly language instruction and its operands into machine code. To *decode* an instruction means to convert a machine code instruction into an assembly language instruction and its operands.

The x86 machine instruction format contains an optional prefix byte, an opcode, a optional Mod R/M byte, optional immediate bytes, and optional memory displacement bytes. Few instructions contain all of the fields. The prefix byte overrides the default operand size for the target processor. The opcode byte contains the instruction's unique operation code. The Mod R/M field identifies the addressing mode and operands. In instructions using register operands, the Mod R/M byte contains a 3-bit identifier for each register operand.

## 12.5 Key Terms

|                                         |                                |
|-----------------------------------------|--------------------------------|
| address displacement                    | Mod R/M byte                   |
| binary-coded decimal (BCD)              | NaN (Not a Number)             |
| binary long division                    | negative infinity              |
| Complex Instruction Set Computer (CISC) | normalized finite number       |
| control register                        | normalized form                |
| concurrency                             | opcode register                |
| decode an instruction                   | positive infinity              |
| denormalize                             | postfix expression             |
| double extended precision               | prefix byte                    |
| double precision                        | quiet NaN                      |
| encode an instruction                   | RC field                       |
| exponent                                | Reduced Instruction Set (RISC) |
| expression stack                        | register stack                 |
| extended real                           | rounding                       |
| floating-point exception                | Scale Index Byte (SIB)         |
| FPU control word                        | short real                     |
| immediate data                          | sign                           |
| indefinite number                       | signaling NaN                  |
| infix expression                        | significand                    |
| last data pointer register              | single precision               |
| last instruction pointer register       | status register                |
| long real                               | tag register                   |
| mantissa                                | temporary real                 |
| masked exception                        | unmasked exception             |

## 12.6 Review Questions and Exercises

### 12.6.1 Short Answer

- Given the binary floating-point value 1101.01101, how can it be expressed as a sum of decimal fractions?
- Why cannot decimal 0.2 be represented exactly by a finite number of bits?
- Given the binary value 11011.01011, what is its normalized value?
- Given the binary value 0000100111101.1, what is its normalized value?
- What are the two types of NaNs?
- What is the largest data type permitted by the FLD instruction, and how many bits does it contain?
- How is the FSTP instruction different from FST?



8. Which instruction changes the sign of a floating-point number?
9. What types of operands may be used with the FADD instruction?
10. How is the FISUB instruction different from FSUB?
11. In processors prior to the P6 family, which instruction compares two floating-point values?
12. Which instruction loads an integer operand into ST(0)?
13. Which field in the FPU control word lets you change the processor's rounding mode?

### 12.6.2 Algorithm Workbench

1. Show the IEEE single-precision encoding of binary +1110.011.
2. Convert the fraction  $5/8$  to a binary real.
3. Convert the fraction  $17/32$  to a binary real.
4. Convert the decimal value +10.75 to IEEE single-precision real.
5. Convert the decimal value  $-76.0625$  to IEEE single-precision real.
6. Write a two-instruction sequence that moves the FPU status flags into the EFLAGS register.
7. Given a precise result of 1.010101101, round it to an 8-bit significand using the FPU's default rounding method.
8. Given a precise result of  $-1.010101101$ , round it to an 8-bit significand using the FPU's default rounding method.
9. Write instructions that implement the following C++ code:

```
double B = 7.8;
double M = 3.6;
double N = 7.1;
double P = -M * (N + B);
```

10. Write instructions that implement the following C++ code:

```
int B = 7;
double N = 7.1;
double P = sqrt(N) + B;
```

11. Provide opcodes for the following MOV instructions:

```
.data
myByte BYTE ?
myWord WORD ?
.code
mov ax,@data
mov ds,ax
mov es,ax ; a.
mov dl,b1 ; b.
mov bl,[di] ; c.
mov ax,[si+2] ; d.
mov al,myByte ; e.
mov dx,myWord ; f.
```

12. Provide Mod R/M bytes for the following MOV instructions:

```
.data
array WORD 5 DUP(?)
.code
mov ax,@data
mov ds,ax
mov BYTE PTR array,5           ; a.
mov dx,[bp+5]                  ; b.
mov [di],bx                    ; c.
mov [di+2],dx                  ; d.
mov array[si+2],ax            ; e.
mov array[bx+di],ax           ; f.
```

13. Assemble the following instructions by hand and write the hexadecimal machine language bytes for each labeled instruction. Assume that val1 is located at offset 0. Where 16-bit values are used, the bytes must appear in little endian order:

```
.data
val1 BYTE 5
val2 WORD 256
.code
mov ax,@data
mov ds,ax                      ; a.
mov al,val1                    ; b.
mov cx,val2                    ; c.
mov dx,OFFSET val1            ; d.
mov dl,2                      ; e.
mov bx,1000h                  ; f.
```

## 12.7 Programming Exercises

### ★ 1. Floating-Point Comparison

Implement the following C++ code in assembly language. Substitute calls to WriteString for the printf() function calls:

```
double X;
double Y;
if( X < Y )
    printf("X is lower\n");
else
    printf("X is not lower\n");
```

(Use Irvine32 library routines for console output, rather than calling the Standard C library's printf function.) Run the program several times, assigning a range of values to X and Y that test your program's logic.

### ★★★ 2. Display Floating-Point Binary

Write a procedure that receives a single-precision floating-point binary value and displays it in the following format: sign: display + or -; significand: binary floating-point, prefixed by "1.";

exponent: display in decimal, unbiased, preceded by the letter E and the exponent's sign.  
Sample:

```
.data
sample REAL4 -1.75
```

Displayed output:

```
-1.110000000000000000000000 E+0
```

### ★★ 3. Set Rounding Modes

(Requires knowledge of macros.) Write a macro that sets the FPU rounding mode. The single input parameter is a two-letter code:

- RE: Round to nearest even
- RD: Round down toward negative infinity
- RU: Round up toward positive infinity
- RZ: Round toward zero (truncate)

Sample macro calls (case should not matter):

```
mRound Re
mRound rd
mRound RU
mRound rZ
```

Write a short test program that uses the FIST (store integer) instruction to test each of the possible rounding modes.

### ★★ 4. Expression Evaluation

Write a program that evaluates the following arithmetic expression:

$$((A + B) / C) * ((D - A) + E)$$

Assign test values to the variables and display the resulting value.

### ★ 5. Area of a Circle

Write a program that prompts the user for the radius of a circle. Calculate and display the circle's area. Use the ReadFloat and WriteFloat procedures from the book's library. Use the FLDPI instruction to load  $\pi$  onto the register stack.

### ★★★ 6. Quadratic Formula

Prompt the user for coefficients a, b, and c of a polynomial in the form  $ax^2 + bx + c = 0$ . Calculate and display the real roots of the polynomial using the *quadratic formula*. If any root is imaginary, display an appropriate message.

### ★★ 7. Showing Register Status Values

The Tag register (Section 12.2.1) indicates the type of contents in each FPU register, using 2 bits for each (Fig. 12-7). You can load the Tag word by calling the FSTENV instruction, which fills in the following protected-mode structure (defined in *Irvine32.inc*):

```

FPU_ENVIRON STRUCT
    controlWord    WORD ?
    ALIGN DWORD
    statusWord     WORD ?
    ALIGN DWORD
    tagWord        WORD ?
    ALIGN DWORD
    instrPointerOffset    DWORD ?
    instrPointerSelector  DWORD ?
    operandPointerOffset  DWORD ?
    operandPointerSelector WORD ?
    WORD ?          ; not used
FPU_ENVIRON ENDS

```

Write a program that pushes two or more values on the FPU stack, displays the stack by calling ShowFPUStack, displays the Tag value of each FPU data register, and displays the register number that corresponds to ST(0). (For the latter, call the FSTSW instruction to save the status word in a 16-bit integer variable, and extract the stack TOP indicator from bits 11 through 13.) Use the following sample output as a guide:

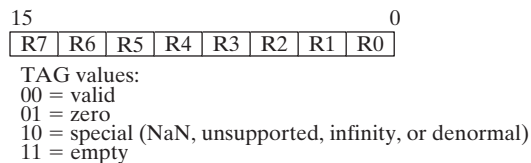
```

----- FPU Stack -----
ST(0): +1.5000000E+000
ST(1): +2.0000000E+000
R0  is empty
R1  is empty
R2  is empty
R3  is empty
R4  is empty
R5  is empty
R6  is valid
R7  is valid
ST(0) = R6

```

From the sample output, we can see that ST(0) is R6, and therefore ST(1) is R7. Both contain valid floating-point numbers.

FIGURE 12-7 Tag word values.



**End Notes**

1. *Intel 64 and IA-32 Architectures Software Developer's Manual*, Vol. 1, Chapter 4. See also <http://grouper.ieee.org/groups/754/>.
2. *Intel 64 and IA-32 Architectures Software Developer's Manual*, Vol. 1, Chapter 4.
3. From Harvey Nice of DePaul University.
4. MASM uses a no-parameter FADD to perform the same operation as Intel's no-parameter FADDP.
5. MASM uses a no-parameter FSUB to perform the same operation as Intel's no-parameter FSUBP.
6. MASM uses a no-parameter FMUL to perform the same operation as Intel's no-parameter FMULP.
7. MASM uses a no-parameter FDIV to perform the same operation as Intel's no-parameter FDIVP.

---

# High-LEVEL LANGUAGE INTERFACE

- 13.1 Introduction
  - 13.1.1 General Conventions
  - 13.1.2 .MODEL Directive
  - 13.1.3 Examining Compiler-Generated Code
  - 13.1.4 Section Review
- 13.2 Inline Assembly Code
  - 13.2.1 `__asm` Directive in Visual C++
  - 13.2.2 File Encryption Example
  - 13.2.3 Section Review
- 13.3 Linking 32-Bit Assembly Language Code to C/C++
  - 13.3.1 `IndexOf` Example
  - 13.3.2 Calling C and C++ Functions
  - 13.3.3 Multiplication Table Example
  - 13.3.4 Calling C Library Functions
  - 13.3.5 Directory Listing Program
  - 13.3.6 Section Review
- 13.4 Chapter Summary
- 13.5 Key Terms
- 13.6 Review Questions
- 13.7 Programming Exercises

## 13.1 Introduction

Most programmers do not write large-scale applications in assembly language because doing so would require too much time. Instead, high-level languages hide details that would otherwise slow down a project's development. Assembly language is still used widely, however, to configure hardware devices and optimize both the speed and code size of programs.

In this chapter, we focus on the interface, or connection, between assembly language and high-level programming languages. In the first section, we will show how to write inline assembly code in C++. In the next section, we will link 32-bit assembly language modules to C++ programs. Finally, we will show how to call C library functions from assembly language.

### 13.1.1 General Conventions

There are a number of general considerations that must be addressed when calling assembly language procedures from high-level languages.

First, the *naming convention* used by a language refers to the rules or characteristics regarding the naming of variables and procedures. For example, we have to answer an important question: Does the assembler or compiler alter the names of identifiers placed in object files, and if so, how?

Second, segment names must be compatible with those used by the high-level language.

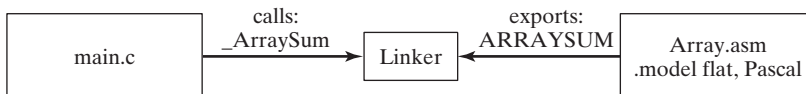
Third, the memory model used by a program (tiny, small, compact, medium, large, huge, or flat) determines the segment size (16 or 32 bits), and whether calls and references will be near (within the same segment) or far (between different segments).

**Calling Convention** The *calling convention* refers to the low-level details about how procedures are called. The following details must be considered:

- Which registers must be preserved by called procedures
- The method used to pass arguments: in registers, on the stack, in shared memory, or by some other method
- The order in which arguments are passed by calling programs to procedures
- Whether arguments are passed by value or by reference
- How the stack pointer is restored after a procedure call
- How functions return values to calling programs

**Naming Conventions and External Identifiers** When calling an assembly language procedure from a program written in another language, external identifiers must have compatible naming conventions (naming rules). *External identifiers* are names that have been placed in a module's object file in such a way that the linker can make the names available to other program modules. The linker resolves references to external identifiers, but can only do so if the naming conventions being used are consistent.

For example, suppose a C program named *Main.c* calls an external procedure named **ArraySum**. As illustrated in the following diagram, the C compiler automatically preserves case and appends a leading underscore to the external name, changing it to **ArraySum**:



The *Array.asm* module, written in assembly language, exports the **ArraySum** procedure name as **ARRAYSUM** because the module uses the Pascal language option in its **.MODEL** directive. The linker fails to produce an executable program because the two exported names are different.

Compilers for older programming languages such as COBOL and PASCAL usually convert identifiers to all uppercase letters. More recent languages such as C, C++, and Java preserve the case of identifiers. In addition, languages that support function overloading (such as C++) use a

technique known as *name decoration* that adds additional characters to function names. A function named `MySub(int n, double b)`, for example, might be exported as `MySub#int#double`.

In an assembly language module, you can control case sensitivity by choosing one of the language specifiers in the `.MODEL` directive.

**Segment Names** When linking an assembly language procedure to a program written in a high-level language, segment names must be compatible. In this chapter, we use the Microsoft simplified segment directives `.CODE`, `.STACK`, and `.DATA` because they are compatible with segment names produced by Microsoft C++ compilers.

**Memory Models** A calling program and a called procedure must both use the same memory model. In real-address mode, for example, you can choose from the small, medium, compact, large, and huge models. In protected mode, you must use the flat model. We show examples of both modes in this chapter.

### 13.1.2 .MODEL Directive

In 16-bit and 32-bit modes, MASM uses the `.MODEL` directive to determine several important characteristics of a program: its memory model type, procedure naming scheme, and parameter passing convention. The last two are particularly important when assembly language is called by programs written in other programming languages. The syntax of the `.MODEL` directive is

```
.MODEL memorymodel [,modeloptions]
```

**MemoryModel** The *memorymodel* field can be one of the models described in Table 13-1. All of the models, with the exception of flat, are used when programming in 16-bit real-address mode.

Table 13-1 Memory Models.

| Model   | Description                                                                                                                              |
|---------|------------------------------------------------------------------------------------------------------------------------------------------|
| Tiny    | A single segment, containing both code and data. This model is used by programs having a <code>.com</code> extension in their filenames. |
| Small   | One code segment and one data segment. All code and data are near, by default.                                                           |
| Medium  | Multiple code segments and a single data segment.                                                                                        |
| Compact | One code segment and multiple data segments.                                                                                             |
| Large   | Multiple code and data segments.                                                                                                         |
| Huge    | Same as the large model, except that individual data items may be larger than a single segment.                                          |
| Flat    | Protected mode. Uses 32-bit offsets for code and data. All data and code (including system resources) are in a single 32-bit segment.    |

32-bit programs use the flat memory model, in which offsets are 32 bits, and the code and data can be as large as 4 GByte. The `Irvine32.inc` file, for example, contains the following `.MODEL` directive:

```
.model flat,STDCALL
```



**ModelOptions** The ModelOptions field in the .MODEL directive can contain both a language specifier and a stack distance. The language specifier determines calling and naming conventions for procedures and public symbols. The stack distance can be NEARSTACK (the default) or FARSTACK.

### Language Specifiers

The .MODEL directive has a number of different possible language specifiers, some of which are rarely used (such as BASIC, FORTRAN, and PASCAL). On the other hand, C and STDCALL are very common. Each is shown here, combined with the flat memory model:

```
.model flat, C
.model flat, STDCALL
```

STDCALL is the language specifier used when calling Windows system functions. In this chapter we use the C language specifier when linking assembly language code to C and C++ programs.

### STDCALL

The STDCALL language specifier causes subroutine arguments to be pushed on the stack in reverse order (last to first). To illustrate, let's write the following function call in a high-level language:

```
AddTwo( 5, 6 );
```

The following assembly language code is equivalent when STDCALL is the chosen language specifier:

```
push 6
push 5
call AddTwo
```

Another important consideration is how arguments are removed from the stack after procedure calls. STDCALL requires a constant operand to be supplied in the RET instruction. The constant indicates the value added to ESP after the return address is popped from the stack by RET:

```
AddTwo PROC
    push ebp
    mov  ebp,esp
    mov  eax,[ebp + 12]    ; second parameter
    add  eax,[ebp + 8]    ; first parameter
    pop  ebp
    ret  8                ; clean up the stack
AddTwo ENDP
```

By adding 8 to the stack pointer, we reset it to the value it had before the arguments were pushed on the stack by the calling program.

Finally, STDCALL modifies exported (public) procedure names by storing them in the following format:

```
_name@nn
```

A leading underscore is added to the procedure name, and an integer follows the @ sign indicating the number of bytes used by the procedure parameters (rounded upward to a multiple of 4). For example, suppose the procedure **AddTwo** has two doubleword parameters. The name passed by the assembler to the linker is **\_AddTwo@8**.

The Microsoft linker is case sensitive, so **\_MYSUB@8** is different from **\_MySub@8**. To view all procedure names inside an OBJ file, use the DUMPBIN utility supplied in Visual Studio with the /SYMBOLS option.

### **C Specifier**

The C language specifier requires procedure arguments to be pushed on the stack from last to first, like STDCALL. Regarding the removal of arguments from the stack after a procedure call, the C language specifier places responsibility on the caller. In the calling program, a constant is added to ESP, resetting it to the value it had before the arguments were pushed:

```

push 6                ; second argument
push 5                ; first argument
call AddTwo
add esp,8             ; clean up the stack

```

The C language specifier appends a leading underscore character to external procedure names. For example:

```
_AddTwo
```

### **13.1.3 Examining Compiler-Generated Code**

C and C++ compilers have been generating assembly language source code for a long time, but programmers usually do not see it. That's because assembly language is an intermediate step in the process of creating an executable file. Fortunately, you can ask most compilers to generate an assembly language source code file. For example, Table 13-2 lists the Visual Studio command line options that control assembly source code output.

TABLE 13-2 Visual C++ Command-Line Options for Assembly Code Generation.

| Command Line | Contents of Listing File           |
|--------------|------------------------------------|
| /FA          | Assembly-only listing              |
| /FAc         | Assembly with machine code         |
| /FAs         | Assembly with source code          |
| /FAcs        | Assembly, machine code, and source |

Examining a compiler-generated code file helps you to understand low-level details such as stack frame construction, coding of loops and logic, and may be useful in looking for low-level programming errors. Another benefit is that you can more easily detect differences between code generated by one compiler versus another.

Let's examine the ways in which a C++ compiler produces optimized code. As an initial example, we can write a simple C method named **ArraySum** and compile it in Visual Studio 2012, using the following settings:

- Optimization = *Disabled* (required when using the debugger)
- Favor Size Or Speed = *Favor fast code*
- Assembler Output = *Assembly With Source Code*

This is the source for **arraySum**, written in ANSI C:

```
int arraySum( int array[], int count )
{
    int i;
    int sum = 0;
    for(i = 0; i < count; i++)
        sum += array[i];
    return sum;
}
```

Let's look at the assembly code generated by the compiler for **arraySum**, shown in Fig. 13-1. Lines 1–4 define negative offsets for the two local variables (**sum** and **i**), and positive offsets for the input parameters **array** and **count**:

```
1:  _sum$ = -8           ; size = 4
2:  _i$ = -4            ; size = 4
3:  _array$ = 8         ; size = 4
4:  _count$ = 12       ; size = 4
```

Lines 9–10 set up **EBP** as the frame pointer:

```
9:   push  ebp
10:  mov   ebp, esp
```

Next, lines 11–14 set aside stack space for local variables by subtracting 72 from **ESP** and saving three registers that will be modified by the function.

```
11:  sub   esp, 72
12:  push  ebx
13:  push  esi
14:  push  edi
```

Line 19 locates the local variable named **sum** inside the stack frame and initializes it to zero. Since the symbol **\_sum\$** was defined with the value  $-8$ , this location is 8 bytes below the current value of **EBP**:

```
19:  mov  DWORD PTR _sum$[ebp], 0
```

Lines 24 and 25 initialize the variable **i** to zero, and jump to Line 30, bypassing statements that will later increment the loop counter:

```
24:  mov  DWORD PTR _i$[ebp], 0
25:  jmp  SHORT $LN3@arraySum
```

Lines 26–30 mark the top of the loop and the place where the loop counter is incremented. The C source code implies that this increment operation (**i++**) is performed at the end of the loop, but the compiler has moved that code to the top of the loop:

```
26: $LN2@arraySum:
27:  mov  eax, DWORD PTR _i$[ebp]
```

```

28:    add  eax, 1
29:    mov  DWORD PTR _i$[ebp], eax

```

Lines 30–33 compare the variable `i` to `count`, and jump just beyond the end of the loop if `i` is greater than or equal to `count`:

```

30: $LN3@arraySum:
31:    mov  eax, DWORD PTR _i$[ebp]
32:    cmp  eax, DWORD PTR _count$[ebp]
33:    jge  SHORT $LN1@arraySum

```

Lines 37–41 evaluate the expression `sum += array[i]`. `Array[i]` is copied into `ECX`, `sum` is copied into `EDX`, and after the addition, `EDX` is copied back into `sum`:

```

37:    mov  eax, DWORD PTR _i$[ebp]
38:    mov  ecx, DWORD PTR _array$[ebp]      ; array[i]
39:    mov  edx, DWORD PTR _sum$[ebp]      ; sum
40:    add  edx, DWORD PTR [ecx+eax*4]
41:    mov  DWORD PTR _sum$[ebp], edx

```

Line 42 returns control to the top of the loop:

```

42:    jmp  SHORT $LN2@arraySum

```

Line 43 holds a label that is just beyond the loop. It is a convenient place to jump to when the loop has finished:

```

43:    $LN1@arraySum:

```

Line 48 moves the `sum` variable into `EAX` in preparation for the return to the calling program. Lines 52–56 restore the saved registers, including `ESP`, which must point to the calling program's return address on the stack.

```

48:    mov  eax, DWORD PTR _sum$[ebp]
49:
50: ; 12 : }
51:
52:    pop  edi
53:    pop  esi
54:    pop  ebx
55:    mov  esp, ebp
56:    pop  ebp
57:    ret  0
58:    _arraySum ENDP

```

You may think you could write faster code than this, and you're probably right. This code was written for interactive debugging, so it compromises speed for readability. If you compile the same program to a release target and select full optimization, the resulting code will execute very fast, but is almost impossible for human readers to understand.

**Debugger Settings** To see assembly language source code while debugging your C and C++ programs in Visual Studio, select *Options* from the *Tools* menu to display the dialog window shown in Fig. 13-2, and select the option indicated by the arrow. Do this before starting the debugger. Then, after a debugging session has begun, right-click the source code window and select *Go to Disassembly* from the popup menu.

Our goal in this chapter is to become familiar with the most straightforward and simple code generation examples produced by the C and C++ compilers. At the same time, it is important to realize that compilers have many ways of generating code. For example, they can optimize code for the fewest possible machine code bytes. Or, they can try to produce the fastest possible code, even if the output results in a larger number of machine code bytes (it usually does). Finally, a compiler can compromise by optimizing for both code size and speed. Code that is optimized for speed may contain more instructions because loops may be unrolled to produce faster execution. Machine code can also be split into two parts to take advantage of dual-core processors and their ability to execute two parallel lines of code at the same time.

FIGURE 13–1 ArraySum assembly code generated by Visual Studio.

```

1:  _sum$ = -8                ; size = 4
2:  _i$ = -4                  ; size = 4
3:  _array$ = 8               ; size = 4
4:  _count$ = 12              ; size = 4
5:  _arraySum PROC           ; COMDAT
6:
7:  ; 4      : {
8:
9:      push    ebp
10:     mov     ebp, esp
11:     sub     esp, 72        ; 00000048H
12:     push    ebx
13:     push    esi
14:     push    edi
15:
16: ; 5      : int i;
17: ; 6      : int sum = 0;
18:
19:     mov     DWORD PTR _sum$[ebp], 0
20:
21: ; 7      :
22: ; 8      : for(i = 0; i < count; i++)
23:
24:     mov     DWORD PTR _i$[ebp], 0
25:     jmp     SHORT $LN3@arraySum
26: $LN2@arraySum:
27:     mov     eax, DWORD PTR _i$[ebp]
28:     add     eax, 1
29:     mov     DWORD PTR _i$[ebp], eax
30: $LN3@arraySum:
31:     mov     eax, DWORD PTR _i$[ebp]
32:     cmp     eax, DWORD PTR _count$[ebp]
33:     jge     SHORT $LN1@arraySum
34:

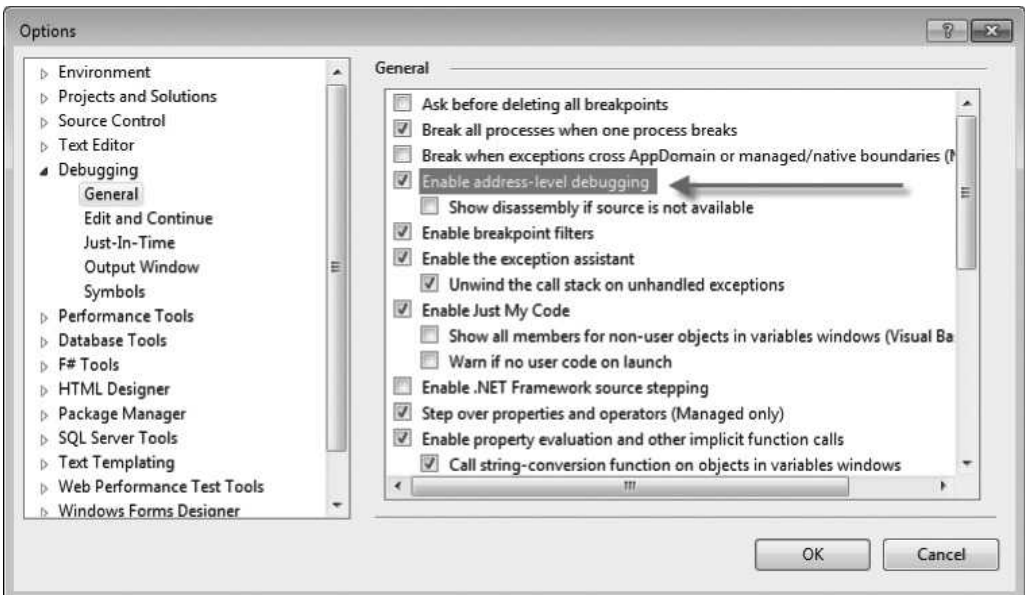
```

```

35: ; 9      :   sum += array[i];
36:
37:  mov     eax, DWORD PTR _i$[ebp]
38:  mov     ecx, DWORD PTR _array$[ebp]
39:  mov     edx, DWORD PTR _sum$[ebp]
40:  add     edx, DWORD PTR [ecx+eax*4]
41:  mov     DWORD PTR _sum$[ebp], edx
42:  jmp     SHORT $LN2@arraySum
43: $LN1@arraySum:
44:
45: ; 10     :
46: ; 11     : return sum;
47:
48:  mov     eax, DWORD PTR _sum$[ebp]
49:
50: ; 12     : }
51:
52:  pop     edi
53:  pop     esi
54:  pop     ebx
55:  mov     esp, ebp
56:  pop     ebp
57:  ret     0
58: _arraySum ENDP

```

FIGURE 13-2 Enabling address-level debugging in Visual Studio.



### 13.1.4 Section Review

1. What is meant by the *naming convention* used by a language?
2. Which memory models are available in real-address mode?
3. Will an assembly language procedure that uses the STDCALL language specifier link to a C++ program?

## 13.2 Inline Assembly Code

### 13.2.1 `__asm` Directive in Visual C++

*Inline assembly code* is assembly language source code that is inserted directly into high-level language programs. Most C and C++ compilers support this feature.

In this section, we demonstrate how to write inline assembly code for Microsoft Visual C++ running in 32-bit protected mode with the flat memory model. Other high-level language compilers support inline assembly code, but the exact syntax varies.

Inline assembly code is a straightforward alternative to writing assembly code in external modules. The primary advantage to writing inline code is simplicity because there are no external linking issues, naming problems, and parameter passing protocols to worry about.

The primary disadvantage to using inline assembly code is its lack of portability. This is an issue when a high-level language program must be compiled for different target platforms. Inline assembly code that runs on an Intel Pentium processor will not run on a RISC processor, for example. To some extent, the problem can be solved by inserting conditional definitions in the program's source code to enable different versions of functions for different target systems. It is easy to see, however, that maintenance is still a problem. A link library of external assembly language procedures, on the other hand, could easily be replaced by a similar link library designed for a different target machine.

*The `__asm Directive`* In Visual C++, the `__asm` directive can be placed at the beginning of a single statement, or it can mark the beginning of a block of assembly language statements (called an *asm block*). The syntax is

```
__asm statement  
  
__asm {  
    statement-1  
    statement-2  
    ...  
    statement-n  
}
```

(There are two underline characters before “asm.”)

*Comments* Comments can be placed after any statements in the asm block, using either assembly language syntax or C/C++ syntax. The Visual C++ manual suggests that you avoid assembler-style comments because they might interfere with C macros, which expand on a single logical line. Here are examples of permissible comments:

```

mov esi,buf      ; initialize index register
mov esi,buf      // initialize index register
mov esi,buf      /* initialize index register */

```

**Features** Here is what you can do when writing inline assembly code:

- Use most instructions from the x86 instruction set.
- Use register names as operands.
- Reference function parameters by name.
- Reference code labels and variables that were declared outside the *asm* block. (This is important because local function variables must be declared outside the *asm* block.)
- Use numeric literals that incorporate either assembler-style or C-style radix notation. For example, 0A26h and 0xA26 are equivalent and can both be used.
- Use the PTR operator in statements such as **inc BYTE PTR [esi]**.
- Use the EVEN and ALIGN directives.

**Limitations** You cannot do the following when writing inline assembly code:

- Use data definition directives such as DB (BYTE) and DW (WORD).
- Use assembler operators (other than PTR).
- Use STRUCT, RECORD, WIDTH, and MASK.
- Use macro directives, including MACRO, REPT, IRC, IRP, and ENDM, or macro operators (<>, !, &, %, and .TYPE).
- Reference segments by name. (You can, however, use segment register names as operands.)

**Register Values** You cannot make any assumptions about register values at the beginning of an *asm* block. The registers may have been modified by code that executed just before the *asm* block. The **\_\_fastcall** keyword in Microsoft Visual C++ causes the compiler to use registers to pass parameters. To avoid register conflicts, do not use **\_\_fastcall** and **\_\_asm** together.

In general, you can modify EAX, EBX, ECX, and EDX in your inline code because the compiler does not expect these values to be preserved between statements. If you modify too many registers, however, you may make it impossible for the compiler to fully optimize the C++ code in the same procedure because optimization requires the use of registers.

Although you cannot use the OFFSET operator, you can retrieve the offset of a variable using the LEA instruction. For example, the following instruction moves the offset of **buffer** to ESI:

```
lea esi,buffer
```

**Length, Type, and Size** You can use the LENGTH, SIZE, and TYPE operators with the inline assembler. The LENGTH operator returns the number of elements in an array. The TYPE operator returns one of the following, depending on its target:

- The number of bytes used by a C or C++ type or scalar variable
- The number of bytes used by a structure
- For an array, the size of a single array element

The SIZE operator returns LENGTH \* TYPE. The following program excerpt demonstrates the values returned by the inline assembler for various C++ types.



Microsoft Visual C++ inline assembler does not support the SIZEOF and LENGTHOF operators.

### Using the LENGTH, TYPE, and SIZE Operators

The following program contains inline assembly code that uses the LENGTH, TYPE, and SIZE operators to evaluate C++ variables. The value returned by each expression is shown as a comment on the same line:

```

struct Package {
    long originZip;           // 4
    long destinationZip;     // 4
    float shippingPrice;     // 4
};

char myChar;
bool myBool;
short myShort;
int myInt;
long myLong;
float myFloat;
double myDouble;
Package myPackage;

long double myLongDouble;
long myLongArray[10];

__asm {
    mov  eax,myPackage.destinationZip;

    mov  eax,LENGTH myInt;           // 1
    mov  eax,LENGTH myLongArray;    // 10

    mov  eax,TYPE myChar;           // 1
    mov  eax,TYPE myBool;           // 1
    mov  eax,TYPE myShort;          // 2
    mov  eax,TYPE myInt;            // 4
    mov  eax,TYPE myLong;           // 4
    mov  eax,TYPE myFloat;          // 4
    mov  eax,TYPE myDouble;         // 8
    mov  eax,TYPE myPackage;        // 12
    mov  eax,TYPE myLongDouble;     // 8
    mov  eax,TYPE myLongArray;      // 4

    mov  eax,SIZE myLong;           // 4
    mov  eax,SIZE myPackage;        // 12
    mov  eax,SIZE myLongArray;      // 40
}

```

### 13.2.2 File Encryption Example

We will look at a short program that reads a file, encrypts it, and writes the output to another file. The `TranslateBuffer` function uses an `__asm` block to define statements that loop through a character array and XOR each character with a predefined value. The inline statements can refer to function parameters, local variables, and code labels. Because this example was compiled

under Microsoft Visual C++ as a Win32 Console application, the unsigned integer data type is 32 bits:

```
void TranslateBuffer( char * buf,
                    unsigned count, unsigned char eChar )
{
    __asm {
        mov  esi,buf
        mov  ecx,count
        mov  al,eChar

    L1:
        xor  [esi],al
        inc  esi
        loop L1
    }    // asm
}
```

*C++ Module* The C++ startup program reads the names of the input and output files from the command line. It calls `TranslateBuffer` from a loop that reads blocks of data from a file, encrypts it, and writes the translated buffer to a new file:

```
// ENCODE.CPP - Copy and encrypt a file.

#include <iostream>
#include <fstream>
#include "translat.h"

using namespace std;

int main( int argcount, char * args[] )
{
    // Read input and output files from the command line.
    if( argcount < 3 ) {
        cout << "Usage: encode infile outfile" << endl;
        return -1;
    }

    const int BUFSIZE = 2000;
    char buffer[BUFSIZE];
    unsigned int count;           // character count

    unsigned char encryptCode;
    cout << "Encryption code [0-255]? ";
    cin >> encryptCode;

    ifstream infile( args[1], ios::binary );
    ofstream outfile( args[2], ios::binary );

    cout << "Reading" << args[1] << "and creating"
         << args[2] << endl;

    while (!infile.eof() )
    {
        infile.read(buffer, BUFSIZE);
        count = infile.gcount();
```

```

        TranslateBuffer(buffer, count, encryptCode);
        outfile.write(buffer, count);
    }
    return 0;
}

```

It's easiest to run this program from a command prompt, passing the names of the input and output files. For example, the following command line reads *infile.txt* and produces *encoded.txt*:

```
encode infile.txt encoded.txt
```

**Header File** The *translat.h* header file contains a single function prototype for **TranslateBuffer**:

```
void TranslateBuffer(char * buf, unsigned count,
                    unsigned char eChar);
```

You can view this program in the book's `\Examples\ch13\VisualCPP\Encode` folder.

### Procedure Call Overhead

If you view the Disassembly window while debugging this program in a debugger, it is interesting to see exactly how much overhead can be involved in calling and returning from a procedure. The following statements push three arguments on the stack and call **TranslateBuffer**. In the Visual C++ Disassembly window, we activated the *Show Source Code* and *Show Symbol Names* options:

```

; TranslateBuffer(buffer, count, encryptCode)
mov     al,byte ptr [encryptCode]
push   eax
mov     ecx,dword ptr [count]
push   ecx
lea    edx,[buffer]
push   edx
call   TranslateBuffer (4159BFh)
add    esp,0Ch

```

The following code is a disassembly of **TranslateBuffer**. A number of statements were automatically inserted by the compiler to set up EBP and save a standard set of registers that are always preserved whether or not they are actually modified by the procedure:

```

push   ebp
mov     ebp,esp
sub     esp,40h
push   ebx
push   esi
push   edi

; Inline code begins here.
mov     esi,dword ptr [buf]
mov     ecx,dword ptr [count]
mov     al,byte ptr [eChar]
L1:

```

```

    xor byte ptr [esi],al
    inc esi
    loop L1 (41D762h)
; End of inline code.

pop    edi
pop    esi
pop    ebx
mov    esp,ebp
pop    ebp
ret

```

If we turn off the *Display Symbol Names* option in the debugger's Disassembly window, the three statements that move parameters to registers appear as:

```

mov    esi,dword ptr [ebp+8]
mov    ecx,dword ptr [ebp+0Ch]
mov    al,byte ptr [ebp+10h]

```

The compiler was instructed to generate a *Debug* target, which is nonoptimized code suitable for interactive debugging. If we had selected a *Release* target, the compiler would have generated more efficient (but harder to read) code.

**Omit the Procedure Call** The six inline instructions in the **TranslateBuffer** function shown at the beginning of this section required a total of 18 instructions to execute. If the function were called thousands of times, the required execution time might be measurable. To avoid this overhead, let's insert the inline code into the loop that called **TranslateBuffer**, creating a more efficient program:

```

while (!infile.eof() )
{
    infile.read(buffer, BUFSIZE );
    count = infile.gcount();
    __asm {
        lea esi,buffer
        mov ecx,count
        mov al,encryptCode
    L1:
        xor [esi],al
        inc esi
        Loop L1
    } // asm
    outfile.write(buffer, count);
}

```

You can view this program in the book's `\Examples\ch13\VisualCPP\Encode_Inline` folder.

### 13.2.3 Section Review

1. How is inline assembly code different from an inline C++ procedure?
2. What advantage does inline assembly code offer over the use of external assembly language procedures?

3. Show at least two ways of placing comments in inline assembly code.
4. (*Yes/No*): Can an inline statement refer to code labels outside the `__asm` block?

### 13.3 Linking 32-Bit Assembly Language Code to C/C++

Programmers who create device drivers and code for embedded systems must often integrate C/C++ modules with specialized code written in assembly language. Assembly language is particularly good at direct hardware access, bit mapping, and low-level access to registers and CPU status flags. It would be tedious to write an entire application in assembly language, but it can be useful to write the main application in C/C++ and use assembly language to write only the code that would otherwise be awkward to write in C. Let's discuss some of the standard requirements for calling assembly language routines from 32-bit C/C++ programs.

Arguments are passed by a C/C++ program from right to left, as they appear in the argument list. After a function returns, the calling program is responsible for restoring the stack to its previous state. This can be done by either adding a value to the stack pointer equal to the size of the arguments or popping an adequate number of values from the stack.

In assembly language source code, you need to specify the C calling convention in the `.MODEL` directive and create a prototype for each procedure called from an external C/C++ program. Here is an example:

```
.586
.model flat,C
IndexOf PROTO,
    srchVal:DWORD, arrayPtr:PTR DWORD, count:DWORD
```

*Declaring the Function* In a C program, use the **extern** qualifier when declaring an external assembly language procedure. For example, this is how to declare **IndexOf**:

```
extern long IndexOf( long n, long array[], unsigned count );
```

If the procedure will be called from a C++ program, add a "C" qualifier to prevent C++ name decoration:

```
extern "C" int IndexOf( long n, long array[], unsigned count );
```

*Name decoration* is a standard C++ compiler technique that involves modifying a function name with extra characters that indicate the exact type of each function parameter. It is required in any language that supports function overloading (multiple functions having the same name, with different parameter lists). From the assembly language programmer's point of view, the problem with name decoration is that the C++ compiler tells the linker to look for the decorated name rather than the original one when producing the executable file.

#### 13.3.1 IndexOf Example

Let's create a simple assembly language function that performs a linear search for the first matching instance of an integer in an array. If the search is successful, the matching element's index position is found; otherwise, the function returns 1. We will call it from a C++ program. In C++, for example, we might write it like this:

```

long IndexOf( long searchVal, long array[], unsigned count )
{
    for(unsigned i = 0; i < count; i++) {
        if( array[i] == searchVal )
            return i;
    }
    return -1;
}

```

The parameters are the value we wish to find, a pointer to the array, and the size of the array. It is certainly an easy program to write in assembly language. We will put the assembly language code in its own source code file named *IndexOf.asm*. This file will be compiled into an object code file named *IndexOf.obj*. We will use Visual Studio to compile and link the calling C++ program and the assembly language module. The C++ project will use Win32 Console as its output type, although there is no reason it could not be a graphical application. Figure 13-3 contains a listing of the source code in the *IndexOf* module. First, notice in lines 25–28 of the assembly language code that the testing loop is small and efficient. We try to use as few instructions as possible inside a loop that will execute many times:

```

25: L1: cmp [esi+edi*4],eax
26: je found
27: inc edi
28: loop L1

```

If a matching value is found, the program jumps to line 34 and copies EDI into EAX, the register holding the function return value. EDI contains the current index position during the search.

```

34: found:
35: mov eax,edi

```

If a matching value is not found, we assign  $-1$  to EAX and return:

```

30: notFound:
31: mov eax,NOT_FOUND
32: jmp short exit

```

Figure 13-4 contains a listing of the calling C++ program. First, it initializes the array with pseudorandom values:

```

12: long array[ARRAY_SIZE];
13: for(unsigned i = 0; i < ARRAY_SIZE; i++)
14:     array[i] = rand();

```

Lines 18-19 prompt the user for a value to find in the array:

```

18: cout << "Enter an integer value to find: ";
19: cin >> searchVal;

```

Line 23 calls the `time` function from the C library (in `time.h`) and stores the number of seconds since midnight of the current day in the variable named `startTime`:

```

23: time( &startTime );

```

Lines 26 and 27 perform the same search over and over, based on the value of `LOOP_SIZE` (100,000):

```
26:   for( unsigned n = 0; n < LOOP_SIZE; n++)
27:       count = IndexOf( searchVal, array, ARRAY_SIZE );
```

Since the array size is also 100,000, the overall number of execution steps is 100,000 × 100,000, or 10 billion. Lines 31–33 check the time of day again, and display the number of seconds that have elapsed while the loop was running:

```
31:   time( &endTime );
32:   cout << "Elapsed ASM time: " << long(endTime - startTime)
33:       << " seconds. Found = " << boolstr[found] << endl;
```

When tested on a fairly fast computer, the loop executed in 6 seconds. That's not bad for 10 billion iterations. That's about 1.67 billion loop iterations per second. It's important to realize that the program repeated the procedure call overhead (pushing parameters, executing `CALL` and `RET` instructions) 100,000 times. Procedure calls cause quite a bit of extra processing.

FIGURE 13-3 Listing of the *IndexOf* module.

```
1: ; IndexOf function          (IndexOf.asm)
2:
3: .586
4: .model flat,C
5: IndexOf PROTO,
6:   srchVal:DWORD, arrayPtr:PTR DWORD, count:DWORD
7:
8: .code
9: ;-----
10: IndexOf PROC USES ecx esi edi,
11:   srchVal:DWORD, arrayPtr:PTR DWORD, count:DWORD
12: ;
13: ; Performs a linear search of a 32-bit integer array,
14: ; looking for a specific value. If the value is found,
15: ; the matching index position is returned in EAX;
16: ; otherwise, EAX equals -1.
17: ;-----
18:   NOT_FOUND = -1
19:
20:   mov  eax,srchVal      ; search value
21:   mov  ecx,count       ; array size
22:   mov  esi,arrayPtr    ; pointer to array
23:   mov  edi,0           ; index
24:
25: L1:cmp  [esi+edi*4],eax
26:   je   found
27:   inc  edi
28:   loop L1
29:
```

```

30: notFound:
31:   mov  al,NOT_FOUND
32:   jmp  short exit
33:
34: found:
35:   mov  eax,edi
36:
37: exit:
38:   ret
39: IndexOf ENDP
40: END

```

FIGURE 13-4 Listing of the C++ test program that calls *IndexOf*.

```

1: #include <iostream>
2: #include <time.h>
3: #include "indexof.h"
4: using namespace std;
5:
6: int main() {
7:     // Fill an array with pseudorandom integers.
8:     const unsigned ARRAY_SIZE = 100000;
9:     const unsigned LOOP_SIZE = 100000;
10:    char* boolstr[] = {"false","true"};
11:
12:    long array[ARRAY_SIZE];
13:    for(unsigned i = 0; i < ARRAY_SIZE; i++)
14:        array[i] = rand();
15:
16:    long searchVal;
17:    time_t startTime, endTime;
18:    cout << "Enter an integer value to find: ";
19:    cin >> searchVal;
20:    cout << "Please wait...\n";
21:
22:    // Test the Assembly language function.
23:    time( &startTime );
24:    int count = 0;
25:
26:    for( unsigned n = 0; n < LOOP_SIZE; n++)
27:        count = IndexOf( searchVal, array, ARRAY_SIZE );
28:
29:    bool found = count != -1;
30:
31:    time( &endTime );
32:    cout << "Elapsed ASM time: " << long(endTime - startTime)
33:        << " seconds. Found = " << boolstr[found] << endl;
34:
35:    return 0;
36: }

```



### 13.3.2 Calling C and C++ Functions

You can write assembly language programs that call C and C++ functions. There are at least a couple of reasons for doing so:

- Input–output is more flexible under C and C++, with their rich input–output libraries. This is particularly useful when working with floating-point numbers.
- Both languages have extensive math libraries.

When calling functions from the standard C library (or C++ library), you must start the program from a C or C++ `main()` procedure to allow library initialization code to run.

#### **Function Prototypes**

C++ functions called from assembly language code must be defined with the “C” and **extern** keywords. Here’s the basic syntax:

```
extern "C" funcName( paramlist )
{ . . . }
```

Here’s an example:

```
extern "C" int askForInteger( )
{
    cout << "Please enter an integer:";
    //...
}
```

Rather than modifying every function definition, it’s easier to group multiple function prototypes inside a block. Then you can omit **extern** and “C” from the individual function implementations:

```
extern "C" {
    int askForInteger();
    int showInt( int value, unsigned outWidth );
    //etc.
}
```

#### **Assembly Language Module**

If your assembly language module will be calling procedures from the Irvine32 link library, be aware that it uses the following `.MODEL` directive:

```
.model flat, STDCALL
```

Although `STDCALL` is compatible with the Win32 API, it does not match the calling convention used by C programs. Therefore, you must add the C qualifier to the `PROTO` directive when declaring external C or C++ functions to be called by the assembly module:

```
INCLUDE Irvine32.inc
askForInteger PROTO C
showInt PROTO C, value:SDWORD, outWidth:DWORD
```

The C qualifier is required because the linker must match up the function names and parameter lists to functions exported by the C++ module. In addition, the assembler must generate the right code to clean up the stack after the function calls, using the C calling convention (see Section 8.2.4).

Assembly language procedures called by the C++ program must use also the C qualifier so the assembler will use a naming convention the linker can recognize. The following **SetTextColor** procedure, for example, has a single doubleword parameter:

```
SetTextOutColor PROC C,
    color:DWORD
    :
    :
SetTextOutColor ENDP
```

Finally, if your assembly code calls other assembly language procedures, the C calling convention requires you to remove parameters from the stack after each procedure call.

*Using the .MODEL Directive* If your assembly language code does not call Irvine32 procedures, you can tell the .MODEL directive to use the C calling convention:

```
; (do not INCLUDE Irvine32.inc)
.586
.model flat,C
```

Now you no longer have to add the C qualifier to the PROTO and PROC directives:

```
askForInteger PROTO
showInt PROTO, value:SDWORD, outWidth:DWORD

SetTextOutColor PROC,
    color:DWORD
    :
    :
SetTextOutColor ENDP
```

### Function Return Values

The C++ language specification says nothing about code implementation details, so there is no standardized way for C and C++ functions to return values. When you write assembly language code that calls functions in these languages, check your compiler's documentation to find out how their functions return values. The following list contains several, but by no means all, possibilities:

- Integers can be returned in a single register or combination of registers.
- Space for function return values can be reserved on the stack by the calling program. The function can insert the return values into the stack before returning.
- Floating-point values are usually pushed on the processor's floating-point stack before returning from the function.

The following list shows how Microsoft Visual C++ functions return values:

- **bool** and **char** values are returned in AL.
- **short int** values are returned in AX.
- **int** and **long int** values are returned in EAX.
- Pointers are returned in EAX.
- **float**, **double**, and **long double** values are pushed on the floating-point stack as 4-, 8-, and 10-byte values, respectively.

### 13.3.3 Multiplication Table Example

Let's write a simple application that prompts the user for an integer, multiplies it by ascending powers of 2 (from  $2^1$  to  $2^{10}$ ) using bit shifting, and redisplay each product with leading padded spaces. We will use C++ for the input–output. The assembly language module will contain calls to three functions written in C++. The program will be launched by a module written in C++.

#### *Assembly Language Module*

The assembly language module contains one function, named **DisplayTable**. It calls a C++ function named **askForInteger** that inputs an integer from the user. It uses a loop to repeatedly shift an integer named **intVal** to the left and display it by calling **showInt**.

```

; ASM function called from C++
INCLUDE Irvine32.inc

; External C++ functions:
askForInteger PROTO C
showInt PROTO C, value:SDWORD, outWidth:DWORD
newLine PROTO C

OUT_WIDTH = 8
ENDING_POWER = 10

.data
intVal DWORD ?

.code
;-----
SetTextOutColor PROC C,
    color:DWORD
;
; Sets the text colors and clears the console
; window. Calls Irvine32 library functions.
;-----
    mov     eax,color
    call   SetTextColor
    call   Clrscr
    ret
SetTextOutColor ENDP

;-----
DisplayTable PROC C
;
; Inputs an integer n and displays a
; multiplication table ranging from n * 2^1
; to n * 2^10.
;-----
    INVOKE askForInteger           ; call C++ function
    mov     intVal,eax             ; save the integer
    mov     ecx,ENDING_POWER      ; loop counter

L1:  push   ecx                    ; save loop counter
     shl   intVal,1                ; multiply by 2

```

```

        INVOKE showInt,intVal,OUT_WIDTH
        INVOKE newLine                ; output CR/LF
        pop    ecx                    ; restore loop counter
        loop  L1

        ret
DisplayTable ENDP
END

```

In the `DisplayTable` procedure, `ECX` must be pushed and popped before calling `showInt` and `newLine` because Visual C++ functions do not save and restore general-purpose registers. The `askForInteger` function returns its result in the `EAX` register.

`DisplayTable` is not required to use `INVOKE` when calling the C++ functions. The same result could be achieved using `PUSH` and `CALL` instructions. This is how the call to `showInt` would look:

```

        push  OUT_WIDTH                ; push last argument first
        push  intVal
        call  showInt                 ; call the function
        add   esp,8                   ; clean up stack

```

You must follow the C language calling convention, in which arguments are pushed on the stack in reverse order and the caller is responsible for removing arguments from the stack after the call.

### **C++ Test Program**

Let's look at the C++ module that starts the program. Its entry point is `main()`, ensuring the execution of required C++ language initialization code. It contains function prototypes for the external assembly language procedure and the three exported functions:

```

// main.cpp

// Demonstrates function calls between a C++ program
// and an external assembly language module.

#include <iostream>
#include <iomanip>
using namespace std;

extern "C" {
    // external ASM procedures:
    void DisplayTable();
    void SetTextOutColor(unsigned color);

    // local C++ functions:
    int askForInteger();
    void showInt(int value, int width);
}

// program entry point
int main()

```

```
{
    SetTextOutColor( 0x1E );           // yellow on blue
    DisplayTable();                   // call ASM procedure
    return 0;
}

// Prompt the user for an integer.

int askForInteger()
{
    int n;
    cout << "Enter an integer between 1 and 90,000:";
    cin >> n;
    return n;
}

// Display a signed integer with a specified width.

void showInt( int value, int width )
{
    cout << setw(width) << value;
}
```

**Building the Project** Add both the C++ and assembly language modules to the Visual Studio project, and select *Build Solution* from the Project menu.

**Program Output** Here is the sample output generated by the Multiplication Table program when the user enters 90,000:

```
Enter an integer between 1 and 90,000: 90000
 180000
 360000
 720000
1440000
2880000
5760000
11520000
23040000
46080000
92160000
```

### **Visual Studio Project Properties**

If you're using Visual Studio to build programs that integrate C++ and assembly language and make calls to the Irvine32 library, you need to alter some project settings. We'll use the Multiplication\_Table program as an example. Select *Properties* from the Project menu. Under *Configuration Properties* entry on the left side of the window, select *Linker*. In the panel on

the right side, enter `c:\Irvine` into the *Additional Library Directories* entry. An example is shown in Fig. 13-5. Click on OK to close the Public Property Pages window. Now Visual Studio can find the Irvine32 library.

The information here was tested in Visual Studio 2012, but is subject to change. Please see our Web site ([www.asmirvine.com](http://www.asmirvine.com)) for updates.

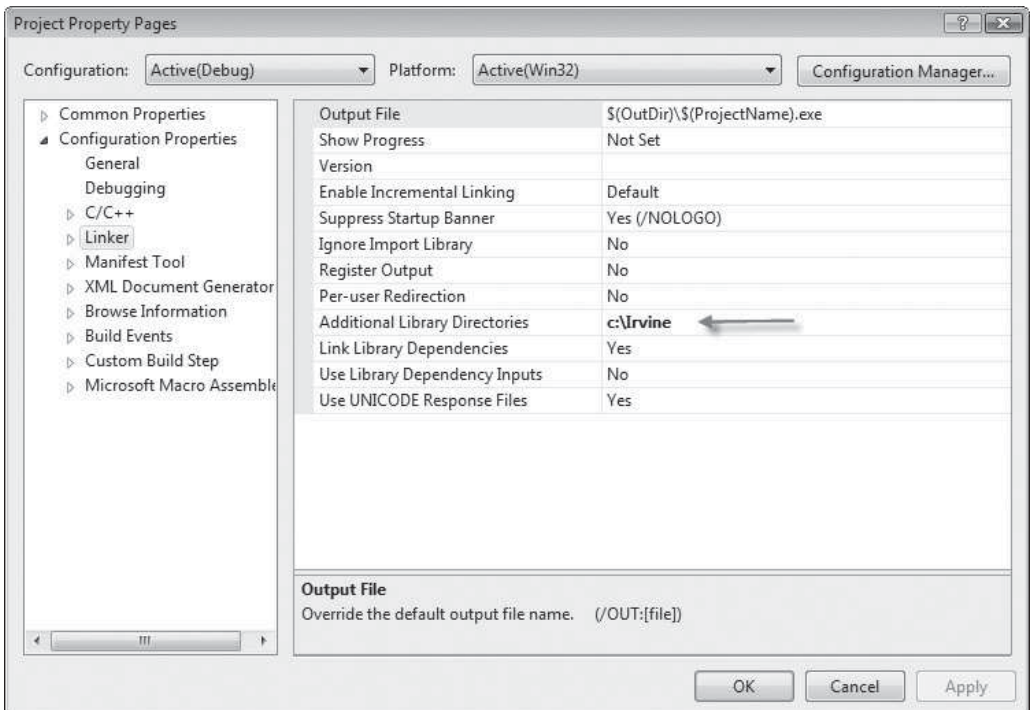
### 13.3.4 Calling C Library Functions

The C language has a standardized collection of functions named the *Standard C Library*. The same functions are available to C++ programs, and therefore to assembly language modules attached to C and C++ programs. Assembly language modules must contain a prototype for each C function they call. You can usually find C function prototypes by accessing the help system supplied with your C++ compiler. You must translate C function prototypes into assembly language prototypes before calling them from your program.

*printf Function* The following is the C/C++ language prototype for the `printf` function, showing a pointer to character as its first parameter, followed by a variable number of parameters:

```
int printf(
    const char *format [, argument]...
);
```

FIGURE 13-5 Specifying the location of Irvine32.lib.



(Consult the C/C++ compiler's help library for documentation about the `printf` function.) The equivalent prototype in assembly language changes `char *` into `PTR BYTE`, and it changes the variable-length parameter list into the `VARARG` type:

```
printf PROTO C, pString:PTR BYTE, args:VARARG
```

Another useful function is **`scanf`**, which inputs characters, numbers, and strings from standard input (the keyboard) and assigns the input values to variables:

```
scanf PROTO C, format:PTR BYTE, args:VARARG
```

### ***Displaying Formatted Reals with the `printf` Function***

Writing assembly language functions that format and display floating-point values is not easy. Rather than doing it yourself, you can take advantage of the C library **`printf`** function. You must create a startup module in C or C++ and link it to your assembly language code. Here's how to set up such a program in Visual C++ .NET:

1. Create a Win32 Console program in Visual C++. Create a file named *main.cpp* and insert a **`main`** function that calls **`asmMain`**:

```
extern "C" void asmMain( );
int main( )
{
    asmMain( );
    return 0;
}
```

2. In the same folder as *main.cpp*, create an assembly language module named *asmMain.asm*. It should contain a procedure named **`asmMain`**, declared with the C calling convention:

```
; asmMain.asm
.386
.model flat,stdcall
.stack 2000
.code
asmMain PROC C
    ret
asmMain ENDP
END
```

3. Assemble *asmMain.asm* (but do not link), producing *asmMain.obj*.
4. Add *asmMain.obj* to the C++ project.
5. Build and run the project. If you modify *asmMain.asm*, assemble it again and rebuild the project before running it again.

Once your program has been set up properly, you can add code to *asmMain.asm* that calls C/C++ language functions.

***Displaying Double-Precision Values*** The following assembly language code in **`asmMain`** prints a `REAL8` by calling `printf`:

```
.data
double1 REAL8 1234567.890123
```

```

formatStr BYTE "%.3f",0dh,0ah,0
.code
INVOKE printf, ADDR formatStr, double1

```

This is the corresponding output:

```
1234567.890
```

The format string passed to **printf** here is a little different than it would be in C++. Rather than embedding escape characters such as `\n`, you must insert ASCII codes (0dh, 0ah).

Floating-point arguments passed to `printf` should be declared type `REAL8`. Although it is possible to pass values of type `REAL4`, a fair amount of clever programming is required. You can see how your C++ compiler does it by declaring a variable of type `float` and passing it to `printf`. Compile the program and trace the program's disassembled code with a debugger.

**Multiple Arguments** The `printf` function accepts a variable number of arguments, so we can just as easily format and display two numbers in one function call:

```

TAB = 9
.data
formatTwo BYTE "%.2f",TAB,"%.3f",0dh,0ah,0
val1 REAL8 456.789
val2 REAL8 864.231
.code
INVOKE printf, ADDR formatTwo, val1, val2

```

This is the corresponding output:

```
456.79 864.231
```

(See the project named **Printf\_Example** in the book's *Examples\ch13\VisualCPP* folder.)

### Entering Reals with the `scanf` Function

You can call **scanf** to input floating-point values from the user. The following prototype is defined in *SmallWin.inc* (included by *Irvine32.inc*):

```

scanf PROTO C,
    format:PTR BYTE, args:VARARG

```

Pass it the offset of a format string and the offsets of one or more `REAL4` or `REAL8` variables to hold values entered by the user. Sample calls:

```

.data
strSingle BYTE "%f",0
strDouble BYTE "%lf",0
single1 REAL4 ?
double1 REAL8 ?
.code
INVOKE scanf, ADDR strSingle, ADDR single1
INVOKE scanf, ADDR strDouble, ADDR double1

```

You must invoke your assembly language code from a C or C++ startup program.



### 13.3.5 Directory Listing Program

Let's write a short program that clears the screen, displays the current disk directory, and asks the user to enter a filename. (You might want to extend this program so it opens and displays the selected file.)

*C++ Stub Module* The C++ module contains only a call to **asm\_main**, so we can call it a *stub module*:

```
// main.cpp
// stub module: launches assembly language program
extern "C" void asm_main();    // asm startup proc

void main()
{
    asm_main();
}
```

*ASM Module* The assembly language module contains the function prototypes, several strings, and a **fileName** variable. It calls the **system** function twice, passing it "cls" and "dir" commands. Then **printf** is called, displaying a prompt for a filename, and **scanf** is called so the user can input the name. It does not make any calls to the Irvine32 library, so we can set the .MODEL directive to the C language convention:

```
; ASM program launched from C++      (asmMain.asm)
.586
.MODEL flat,C

; Standard C library functions:
system PROTO, pCommand:PTR BYTE
printf PROTO, pString:PTR BYTE, args:VARARG
scanf PROTO, pFormat:PTR BYTE,pBuffer:PTR BYTE, args:VARARG
fopen PROTO, mode:PTR BYTE, filename:PTR BYTE
fclose PROTO, pFile:DWORD

BUFFER_SIZE = 5000
.data
str1 BYTE "cls",0
str2 BYTE "dir/w",0
str3 BYTE "Enter the name of a file:",0
str4 BYTE "%s",0
str5 BYTE "cannot open file",0dh,0ah,0
str6 BYTE "The file has been opened",0dh,0ah,0
modeStr BYTE "r",0

fileName BYTE 60 DUP(0)
pBuf DWORD ?
pFile DWORD ?

.code
asm_main PROC
```

```

; clear the screen, display disk directory
INVOKE system,ADDR str1
INVOKE system,ADDR str2

; ask for a filename
INVOKE printf,ADDR str3
INVOKE scanf, ADDR str4, ADDR filename

; try to open the file
INVOKE fopen, ADDR fileName, ADDR modeStr
mov  pFile,eax

.IF eax == 0 ; cannot open file?
    INVOKE printf,ADDR str5
    jmp quit
.ELSE
    INVOKE printf,ADDR str6
.ENDIF
; Close the file
INVOKE fclose, pFile

quit:
    ret ; return to C++ main
asm_main ENDP
END

```

The **scanf** function requires two arguments: the first is a pointer to a format string (“%s”), and the second is a pointer to the input string variable (**fileName**). We will not take the time to explain standard C functions because there is ample documentation on the Web. An excellent reference is Brian W. Kernighan and Dennis M. Ritchie, *The C Programming Language*, 2nd Ed., Prentice Hall, 1988.

### 13.3.6 Section Review

1. Which two C++ keywords must be included in a function definition if the function will be called from an assembly language module?
2. In what way is the calling convention used by the Irvine32 library not compatible with the calling convention used by the C and C++ languages?
3. How do C++ functions usually return floating-point values?
4. How does a Microsoft Visual C++ function return a **short int**?

## 13.4 Chapter Summary

Assembly language is the perfect tool for optimizing selected parts of a large application written in some high-level language. Assembly language is also a good tool for customizing certain procedures for specific hardware. These techniques require one of two approaches:

- Write inline assembly code embedded within high-level language code.
- Link assembly language procedures to high-level language code.

Both approaches have their merits and their limitations. In this chapter, we presented both approaches.

The naming convention used by a language refers to the way segments and modules are named, as well as rules or characteristics regarding the naming of variables and procedures. The memory model used by a program determines whether calls and references will be near (within the same segment) or far (between different segments).

When calling an assembly language procedure from a program written in another language, any identifiers that are shared between the two languages must be compatible. You must also use segment names in the procedure that are compatible with the calling program. The writer of a procedure uses the high-level language's calling convention to determine how to receive parameters. The calling convention affects whether the stack pointer must be restored by the called procedure or by the calling program.

In Visual C++, the `__asm` directive is used for writing inline assembly code in a C++ source program. In this chapter, a File Encryption program was used to demonstrate inline assembly language.

This chapter showed how to link assembly language procedures to Microsoft Visual C++ programs running in 32-bit protected mode.

When calling functions from the Standard C (C++) library, create a stub program in C or C++ containing a `main( )` function. When `main( )` starts, the compiler's runtime library is automatically initialized. From `main( )`, you can call a startup procedure in the assembly language module. The assembly language module can call any function from the C Standard Library.

A procedure named `IndexOf` was written in assembly language and called from a Visual C++ program. We also examined assembly language source file generated by the Microsoft C++ compiler to gain a clearer idea of how compilers optimize code.

## 13.5 Key Terms

C language specifier  
external identifier  
inline assembly code  
memory model

name decoration  
naming convention  
STDCALL language specifier

## 13.6 Review Questions

1. When a procedure written in assembly language is called by a high-level language program, must the calling program and the procedure use the same memory model?
2. Why is case sensitivity important when calling assembly language procedures from C and C++ programs?
3. Does a language's calling convention include the preserving of certain registers by procedures?
4. (*Yes/No*): Can both the `EVEN` and `ALIGN` directives be used in inline assembly code?
5. (*Yes/No*): Can the `OFFSET` operator be used in inline assembly code?

6. (*Yes/No*): Can variables be defined with both the DW and the DUP operator in inline assembly code?
7. When using the `__fastcall` calling convention, what might happen if your inline assembly code modifies registers?
8. Rather than using the `OFFSET` operator, is there another way to move a variable's offset into an index register?
9. What value is returned by the `LENGTH` operator when applied to an array of 32-bit integers?
10. What value is returned by the `SIZE` operator when applied to an array of long integers?
11. What is a valid assembly language `PROTO` declaration for the standard C `printf()` function?
12. When the following C language function is called, will the argument `x` be pushed on the stack first or last?

```
void MySub( x, y, z );
```

13. What is the purpose of the "C" specifier in the extern declaration in procedures called from C++?
14. Why is name decoration important when calling external assembly language procedures from C++?
15. Using an Internet search, make a short list of optimization tricks used by C/C++ compilers.

## 13.7 Programming Exercises

### ★★ 1. Multiply an Array by an Integer

Write an assembly language subroutine that multiplies a doubleword array by an integer. Write a test program in C/C++ that creates an array, passes it to the subroutine, and prints the resulting array values.

### ★★★ 2. Longest Increasing Sequence

Write an assembly language subroutine that receives two input parameters: the offset of an array and the array's size. It must return a count of the longest increasing sequence of integer values. For example, in the following array, the longest strictly increasing sequence begins at index 3 and has a length of 4 { 14, 17, 26, 42 }:

```
[ -5, 10, 20, 14, 17, 26, 42, 22, 19, -5 ]
```

Call your subroutine from a C/C++ program that creates the array, passes the arguments, and prints the value returned by the subroutine.

### ★★ 3. Summing Three Arrays

Write an assembly language subroutine that receives the offsets of three arrays, all of equal size. It adds the second and third arrays to the values in the first array. When it returns, the first array has all new values. Write a test program in C/C++ that creates an array, passes it to the subroutine, and prints the contents of the first array.

**★★★ 4. Prime Number Program**

Write an assembly language procedure that returns a value of 1 if the 32-bit integer passed in the EAX register is prime, and 0 if EAX is nonprime. Call this procedure from a high-level language program. Let the user input a sequence of integers, and have your program display a message for each one indicating whether or not it is prime. Suggestion: use the *Sieve of Eratosthenes* algorithm to initialize a boolean array the first time your procedure is called.

**★★ 5. LastIndexOf Procedure**

Modify the **IndexOf** procedure from Section 13.3.1. Name your function **LastIndexOf**, and let it search backward from the end of the array. Return the index of the first matching value, or if no match is found, return  $-1$ .

---

# 16-Bit MS-DOS PROGRAMMING

- 14.1 MS-DOS and the IBM-PC
  - 14.1.1 Memory Organization
  - 14.1.2 Redirecting Input–Output
  - 14.1.3 Software Interrupts
  - 14.1.4 INT Instruction
  - 14.1.5 Coding for 16-Bit Programs
  - 14.1.6 Section Review
- 14.2 MS-DOS Function Calls (INT 21h)
  - 14.2.1 Selected Output Functions
  - 14.2.2 Hello World Program Example
  - 14.2.3 Selected Input Functions
  - 14.2.4 Date/Time Functions
  - 14.2.5 Section Review
- 14.3 Standard MS-DOS File I/O Services
  - 14.3.1 Create or Open File (716Ch)
  - 14.3.2 Close File Handle (3Eh)
  - 14.3.3 Move File Pointer (42h)
  - 14.3.4 Get File Creation Date and Time
  - 14.3.5 Selected Library Procedures
  - 14.3.6 Example: Read and Copy a Text File
  - 14.3.7 Reading the MS-DOS Command Tail
  - 14.3.8 Example: Creating a Binary File
  - 14.3.9 Section Review
- 14.4 Chapter Summary
- 14.5 Programming Exercises

We recommend that you install an early version of Windows such as Windows 98 to insure full compatibility with the programs in this chapter. You may want to use a software utility to create a virtual machine on your computer, so you can experiment with this software.

## 14.1 MS-DOS and the IBM-PC

IBM's PC-DOS was the first operating system to implement real-address mode on the IBM Personal Computer, using the Intel 8088 processor. Later, it evolved into Microsoft MS-DOS. Because of this history, it makes sense to use MS-DOS as the environment for explaining real-address mode programming. Real-address mode is also called *16-bit mode* because addresses are constructed from 16-bit values.

In this chapter, you will learn the basic memory organization of MS-DOS, how to activate MS-DOS function calls (called *interrupts*), and how to perform basic input–output operations at

the operating system level. All of the programs in this chapter run in real-address mode because they use the INT instruction. Interrupts were originally designed to run under MS-DOS in real-address mode. It is possible to call interrupts in protected mode, but the techniques for doing so are beyond the scope of this book.

Real-address mode programs have the following characteristics:

- They can only address 1 megabyte of memory.
- Only one program can run at once (single tasking) in a single session.
- No memory boundary protection is possible, so any application program can overwrite memory used by the operating system.
- Offsets are 16 bits.

When it first appeared, the IBM-PC had a strong appeal because it was affordable and it ran Lotus 1-2-3, the electronic spreadsheet program that was instrumental in the PC's adoption by businesses. Computer hobbyists loved the PC because it was an ideal tool for learning how computers work. It should be noted that Digital Research CP/M, the most popular 8-bit operating system before PC-DOS, was only capable of addressing 64K of RAM. From this point of view, PC-DOS's 640K seemed like a gift from heaven.

Because of the obvious memory and speed limitations of the early Intel microprocessors, the IBM-PC was a single-user computer. There was no built-in protection against memory corruption by application programs. In contrast, the minicomputer systems available at the time could handle multiple users and prevented application programs from overwriting each other's data. Over time, more-robust operating systems for the PC have become available, making it a viable alternative to minicomputer systems, particularly when PCs are networked together.

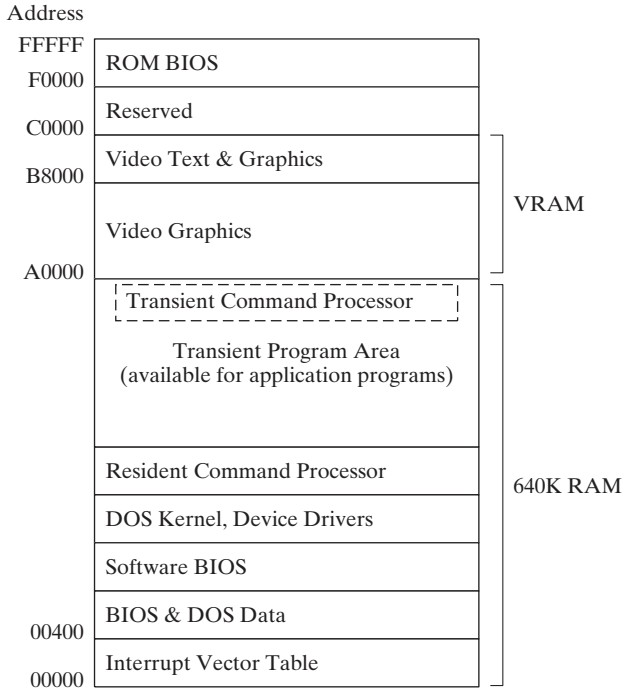
### 14.1.1 Memory Organization

In real-address mode, the lowest 640K of memory is used by both the operating system and application programs. Following this is video memory and reserved memory for hardware controllers. Finally, locations F0000 to FFFFF are reserved for system ROM (read-only memory). Figure 14-1 shows a simple memory map. Within the operating system area of memory, the lowest 1024 bytes of memory (addresses 00000 to 003FF) contain a table of 32-bit addresses named the *interrupt vector table*. These addresses, called *interrupt vectors*, are used by the CPU when processing hardware and software interrupts.

Just above the vector table is the *BIOS and MS-DOS data area*. Next is the *software BIOS*, which includes procedures that manage most I/O devices, including the keyboard, disk drive, video display, serial, and printer ports. BIOS procedures are loaded from a hidden system file on an MS-DOS system (boot) disk. The MS-DOS kernel is a collection of procedures (called *services*) that are also loaded from a file on the system disk.

Grouped with the MS-DOS kernel are the file buffers and installable device drivers. Next highest in memory, the resident part of the *command processor* is loaded from an executable file named *command.com*. The command processor interprets commands typed at the MS-DOS prompt and loads and executes programs stored on disk. A second part of the command processor occupies high memory just below location A0000.

FIGURE 14-1 MS-DOS Memory Map.



Application programs can load into memory at the first address above the resident part of the command processor and can use memory all the way up to address 9FFFF. If the currently running program overwrites the transient command processor area, the latter is reloaded from the boot disk when the program exits.

**Video Memory** The video memory area (VRAM) on an IBM-PC begins at location A0000, which is used when the video adapter is switched into graphics mode. When the video is in color text mode, memory location B8000 holds all text currently displayed on the screen. The screen is memory-mapped, so that each row and column on the screen corresponds to a 16-bit word in memory. When a character is copied into video memory, it immediately appears on the screen.

**ROM BIOS** The *ROM BIOS*, at memory locations F0000 to FFFFF, is an important part of the computer's operating system. It contains system diagnostic and configuration software, as well as low-level input-output procedures used by application programs. The BIOS is stored in a static memory chip on the system board. Most systems follow a standardized BIOS specification modeled after IBM's original BIOS and use the BIOS data area from 00400 to 004FF.

### 14.1.2 Redirecting Input-Output

Throughout this chapter, references will be made to the *standard input device* and the *standard output device*. Both are collectively called the *console*, which involves the keyboard for input and the video display for output.



When running programs from the command prompt, you can redirect standard input so that it is read from a file or hardware port rather than the keyboard. Standard output can be redirected to a file, printer, or other I/O device. Without this capability, programs would have to be substantially revised before their input–output could be changed. For example, the operating system has a program named *sort.exe* that sorts an input file. The following command sorts a file named *myfile.txt* and displays the output:

```
sort < myfile.txt
```

The following command sorts *myfile.txt* and sends the output to *outfile.txt*:

```
sort < myfile.txt > outfile.txt
```

You can use the pipe (|) symbol to copy the output from the DIR command to the input of the *sort.exe* program. The following command sorts the current disk directory and displays the output on the screen:

```
dir | sort
```

The following command sends the output of the sort program to the default (non-networked) printer (identified by PRN):

```
dir | sort > prn
```

The complete set of device names is shown in Table 14-1.

Table 14-1 Standard MS-DOS Device Names.

| Device Name | Description                         |
|-------------|-------------------------------------|
| CON         | Console (video display or keyboard) |
| LPT1 or PRN | First parallel printer              |
| LPT2, LPT3  | Parallel ports 2 and 3              |
| COM1, COM2  | Serial ports 1 and 2                |
| NUL         | Nonexistent or dummy device         |

### 14.1.3 Software Interrupts

A *software interrupt* is a call to an operating system procedure. Most of these procedures, called *interrupt handlers*, provide input–output capability to application programs. They are used for such tasks as the following:

- Displaying characters and strings
- Reading characters and strings from the keyboard
- Displaying text in color
- Opening and closing files
- Reading data from files
- Writing data to files
- Setting and retrieving the system time and date

### 14.1.4 INT Instruction

The INT (*call to interrupt procedure*) instruction calls a system subroutine also known as an *interrupt handler*. Before the INT instruction executes, one or more parameters must be inserted in registers. At the very least, a number identifying the particular procedure must be moved to the AH register. Depending on the function, other values may have to be passed to the interrupt in registers. The syntax is

INT *number*

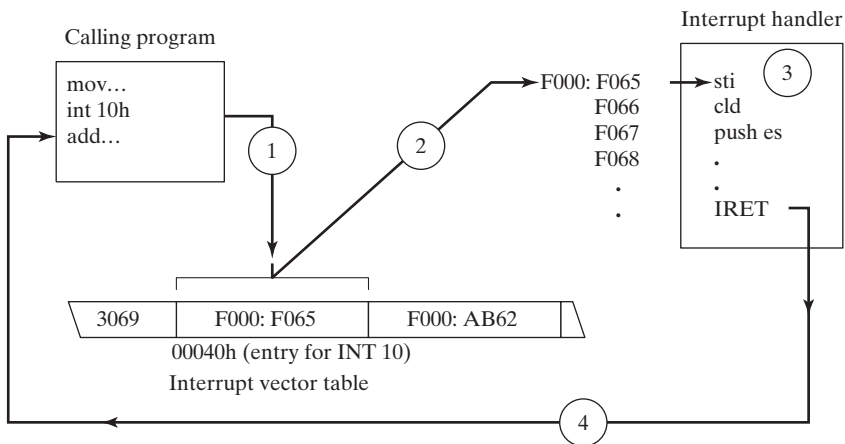
where *number* is an integer in the range 0 to FF hexadecimal.

#### Interrupt Vectoring

The CPU processes the INT instruction using the interrupt vector table, which, as we've mentioned, is a table of addresses in the lowest 1024 bytes of memory. Each entry in this table is a 32-bit segment-offset address that points to an interrupt handler. The actual addresses in this table vary from one machine to another. Figure 14-2 illustrates the steps taken by the CPU when the INT instruction is invoked by a program:

- **Step 1:** The operand of the INT instruction is multiplied by 4 to locate the matching interrupt vector table entry.
- **Step 2:** The CPU pushes the flags and a 32-bit segment/offset return address on the stack, disables hardware interrupts, and executes a far call to the address stored at location (10h \* 4) in the interrupt vector table (F000:F065).
- **Step 3:** The interrupt handler at F000:F065 executes until it reaches an IRET (interrupt return) instruction.
- **Step 4:** The IRET instruction pops the flags and the return address off the stack, causing the processor to resume execution immediately following the INT 10h instruction in the calling program.

FIGURE 14-2 Interrupt Vectoring Process.



### Common Interrupts

Software interrupts call *interrupt service routines* (ISRs) either in the BIOS or in DOS. Some frequently used interrupts are the following:

- **INT 10h Video Services.** Procedures that display routines that control the cursor position, write text in color, scroll the screen, and display video graphics.
- **INT 16h Keyboard Services.** Procedures that read the keyboard and check its status.
- **INT 17h Printer Services.** Procedures that initialize, print, and return the printer status.
- **INT 1Ah Time of Day.** Procedure that gets the number of clock ticks since the machine was turned on or sets the counter to a new value.
- **INT 1Ch User Timer Interrupt.** An empty procedure that is executed 18.2 times per second.
- **INT 21h MS-DOS Services.** Procedures that provide input–output, file handling, and memory management. Also known as *MS-DOS function calls*.

#### 14.1.5 Coding for 16-Bit Programs

Programs designed for MS-DOS must be 16-bit applications running in real-address mode. Real-address mode applications use 16-bit segments and follow the segmented addressing scheme described in Section 2.3.1. If you're using a 32-bit processor, you can use the 32-bit general-purpose registers for data, even in real-address mode. Here is a summary of coding characteristics in 16-bit programs:

- The `.MODEL` directive specifies which memory model your program will use. We recommend the Small model, which keeps your code in one segment and your stack plus data in another segment:

```
.MODEL small
```

- The `.STACK` directive allocates a small amount of local stack space for your program. Ordinarily, you rarely need more than 256 bytes of stack space. The following is particularly generous, with 512 bytes:

```
.STACK 200h
```

- Optionally, you may want to enable the use of 32-bit registers. This can be done with the `.386` directive:

```
.386
```

- Two instructions are required at the beginning of `main` if your program references variables. They initialize the `DS` register to the starting location of the data segment, identified by the predefined MASM constant `@data`:

```
mov ax,@data
mov ds,ax
```

- Every program must include a statement that ends the program and returns to the operating system. One way to do this is to use the `.EXIT` directive:

```
.EXIT
```

Alternatively, you can call INT 21h, Function 4Ch:

```
mov ah,4ch           ; terminate process
int 21h             ; MS-DOS interrupt
```

- You can assign values to segment registers using the `MOV` instruction, but do so only when assigning the address of a program segment.

- When assembling 16-bit programs, use the *make16.bat* (batch) file provided in the example programs folder for this book. It links to *Irvine16.lib* and executes the older Microsoft 16-bit linker (version 5.6).
- Real-address mode programs can only access hardware ports, interrupt vectors, and system memory when running under MS-DOS, Windows 95, 98, and Millenium. Beginning with Windows XP, this type of access is not permitted.
- When the **Small** memory model is used, offsets (addresses) of data and code labels are 16 bits. The *Irvine16* library uses the Small memory model, in which all code fits in a 16-bit segment and the program's data and stack fit into a 16-bit segment.
- In real-address mode, stack entries are 16 bits by default. You can still place a 32-bit value on the stack (it uses two stack entries).

You can simplify coding of 16-bit programs by including the *Irvine16.inc* file. It inserts the following statements into the assembly stream, which define the memory mode and calling convention, allocate stack space, enable 32-bit registers, and redefine the `.EXIT` directive as `exit`:

```
.MODEL small,stdcall
.STACK 200h
.386
exit EQU <.EXIT>
```

### 14.1.6 Section Review

1. What is the highest memory location into which you can load an application program?
2. What occupies the lowest 1024 bytes of memory?
3. What is the starting location of the BIOS and MS-DOS data area?
4. What is the name of the memory area containing low-level procedures used by the computer for input–output?
5. Show an example of redirecting a program's output to the printer.
6. What is the MS-DOS device name for the first parallel printer?
7. What is an interrupt service routine?
8. When the `INT` instruction executes, what is the first task carried out by the CPU?
9. What four steps are taken by the CPU when an `INT` instruction is invoked by a program?  
*Hint:* See Fig. 14-2.
10. When an interrupt service routine finishes, how does an application program resume execution?
11. Which interrupt number is used for video services?
12. Which interrupt number is used for the time of day?
13. What offset within the interrupt vector table contains the address of the `INT 21h` interrupt handler?

## 14.2 MS-DOS Function Calls (INT 21h)

MS-DOS provides a lot of easy-to-use functions for displaying text on the console. They are all part of a group typically called *INT 21h MS-DOS Function calls*. There are about 200 different functions supported by this interrupt, identified by a *function number* placed in the `AH` register. An excellent, if somewhat outdated, source is Ray Duncan's book, *Advanced MS-DOS*

*Programming*, 2nd Ed., Microsoft Press, 1988. A more comprehensive and up-to-date list, named *Ralf Brown's Interrupt List*, can be found on the Web. See the current book's Web site for details.

For each INT 21h function described in this chapter, we will list the necessary input parameters and return values, give notes about its use, and include a short code example that calls the function.

A number of functions require that the 32-bit address of an input parameter be stored in the DS:DX registers. DS, the data segment register, is usually set to your program's data area. If for some reason this is not the case, use the SEG operator to set DS to the segment containing the data passed to INT 21h. The following statements do this:

```
.data
inBuffer BYTE 80 DUP(?)
.code
mov ax,SEG inBuffer
mov ds,ax
mov dx,OFFSET inBuffer
```

**INT 21h Function 4Ch: Terminate Process** INT 21h Function 4Ch terminates the current program (called a *process*). In the real-address mode programs presented in this book, we have relied on a macro definition in the Irvine16 library named **exit**. It is defined as

```
exit TEXTEQU <.EXIT>
```

In other words, **exit** is an alias, or substitute for **.EXIT** (the MASM directive that ends a program). The **exit** symbol was created so you could use a single command to terminate 16-bit and 32-bit programs. In 16-bit programs, the code generated by **.EXIT** is

```
mov ah,4Ch ; terminate process
int 21h
```

If you supply an optional return code argument to the **.EXIT** macro, the assembler generates an additional instruction that moves the return code to AL:

```
.EXIT 0 ; macro call
```

Generated code:

```
mov ah,4Ch ; terminate process
mov al,0 ; return code
int 21h
```

The value in AL, called the *process return code*, is received by the calling process (including a batch file) to indicate the return status of your program. By convention, a return code of zero is considered successful completion. Other return codes between 1 and 255 can be used to indicate additional outcomes that have specific meaning for your program. For example, MLEXE, the Microsoft Assembler, returns 0 if a program assembles correctly and a nonzero value if it does not.

Appendix D contains a fairly extensive list of BIOS and MS-DOS interrupts.

### 14.2.1 Selected Output Functions

In this section we present some of the most common INT 21h functions for writing characters and text. None of these functions alters the default current screen colors, so output will only be in color if you have previously set the screen color by other means. (For example, you can call video BIOS functions from Chapter 16.)

*Filtering Control Characters* All of the functions in this section *filter* or interpret ASCII control characters. If you write a backspace character to standard output, for example, the cursor moves one column to the left. Table 14-2 contains a list of control characters that you are likely to encounter.

TABLE 14-2 ASCII Control Characters.

| ASCII Code | Description                                       |
|------------|---------------------------------------------------|
| 08h        | Backspace (moves one column to the left)          |
| 09h        | Horizontal tab (skips forward <i>n</i> columns)   |
| 0Ah        | Line feed (moves to next output line)             |
| 0Ch        | Form feed (moves to next printer page)            |
| 0Dh        | Carriage return (moves to leftmost output column) |
| 1Bh        | Escape character                                  |

The next several tables describe the important features of INT 21h Functions 2, 5, 6, 9, and 40h. INT 21h Function 2 writes a single character to standard output. INT 21h Function 5 writes a single character to the printer. INT 21h Function 6 writes a single unfiltered character to standard output. INT 21h Function 9 writes a string (terminated by a \$ character) to standard output. INT 21h Function 40h writes an array of bytes to a file or device.

| INT 21h Function 2 |                                                                                       |
|--------------------|---------------------------------------------------------------------------------------|
| <b>Description</b> | Write a single character to standard output and advance the cursor one column forward |
| <b>Receives</b>    | AH = 2<br>DL = character value                                                        |
| <b>Returns</b>     | Nothing                                                                               |
| <b>Sample call</b> | <pre> mov  ah, 2 mov  dl, 'A' int  21h </pre>                                         |

| INT 21h Function 5 |                                                                                                                                                                                  |
|--------------------|----------------------------------------------------------------------------------------------------------------------------------------------------------------------------------|
| <b>Description</b> | Write a single character to the printer                                                                                                                                          |
| <b>Receives</b>    | AH = 5<br>DL = character value                                                                                                                                                   |
| <b>Returns</b>     | Nothing                                                                                                                                                                          |
| <b>Sample call</b> | <pre> mov  ah,5      ; select printer output mov  dl,"Z"    ; character to be printed int  21h      ; call MS-DOS </pre>                                                         |
| <b>Notes</b>       | MS-DOS waits until the printer is ready to accept the character. You can terminate the wait by pressing the Ctrl-Break keys. The default output is to the printer port for LPT1. |

| INT 21h Function 6 |                                                                                                |
|--------------------|------------------------------------------------------------------------------------------------|
| <b>Description</b> | Write a character to standard output                                                           |
| <b>Receives</b>    | AH = 6<br>DL = character value                                                                 |
| <b>Returns</b>     | If ZF = 0, AL contains the character's ASCII code                                              |
| <b>Sample call</b> | <pre> mov  ah,6 mov  dl,"A" int  21h </pre>                                                    |
| <b>Notes</b>       | Unlike other INT 21h functions, this one does not filter (interpret) ASCII control characters. |

| INT 21h Function 9 |                                                                                                    |
|--------------------|----------------------------------------------------------------------------------------------------|
| <b>Description</b> | Write a \$-terminated string to standard output                                                    |
| <b>Receives</b>    | AH = 9<br>DS:DX = segment/offset of the string                                                     |
| <b>Returns</b>     | Nothing                                                                                            |
| <b>Sample call</b> | <pre> .data string BYTE "This is a string\$" .code mov  ah,9 mov  dx,OFFSET string int  21h </pre> |
| <b>Notes</b>       | The string must be terminated by a dollar-sign character (\$)                                      |

| INT 21h Function 40h |                                                                                                                              |
|----------------------|------------------------------------------------------------------------------------------------------------------------------|
| <b>Description</b>   | Write an array of bytes to a file or device                                                                                  |
| <b>Receives</b>      | AH = 40h<br>BX = file or device handle (console = 1)<br>CX = number of bytes to write<br>DS:DX = address of array            |
| <b>Returns</b>       | AX = number of bytes written                                                                                                 |
| <b>Sample call</b>   | <pre>.data message "Hello, world" .code mov  ah,40h mov  bx,1 mov  cx,LENGTHOF message mov  dx,OFFSET message int  21h</pre> |

### 14.2.2 Hello World Program Example

The following is a simple program that displays a string on the screen using an MS-DOS function call:

```
; Hello World Program          (Hello.asm)

.MODEL small
.STACK 100h
.386

.data
message BYTE "Hello, world!",0dh,0ah

.code
main PROC
    mov ax,@data                ; initialize DS
    mov ds,ax

    mov ah,40h                  ; write to file/device
    mov bx,1                    ; output handle
    mov cx,SIZEOF message       ; number of bytes
    mov dx,OFFSET message       ; addr of buffer
    int 21h

    .EXIT
main ENDP
END main
```

*Alternate Version* Another way to write Hello.asm is to use the predefined .STARTUP directive (which initializes the DS register). Doing so requires the removal of the label next to the END directive:



```

; Hello World Program          (Hello2.asm)

.MODEL small
.STACK 100h
.386

.data
message BYTE "Hello, world!",0dh,0ah

.code
main PROC
    .STARTUP

    mov  ah,40h                ; write to file/device
    mov  bx,1                  ; output handle
    mov  cx,SIZEOF message    ; number of bytes
    mov  dx,OFFSET message    ; addr of buffer
    int  21h

    .EXIT
main ENDP
END

```

### 14.2.3 Selected Input Functions

In this section, we describe a few of the most commonly used MS-DOS functions that read from standard input. For a more complete list, see Appendix D. As shown in the following table, INT 21h Function 1 reads a single character from standard input:

| INT 21h Function 1 |                                                                                                                           |
|--------------------|---------------------------------------------------------------------------------------------------------------------------|
| <b>Description</b> | Read a single character from standard input                                                                               |
| <b>Receives</b>    | AH = 1                                                                                                                    |
| <b>Returns</b>     | AL = character (ASCII code)                                                                                               |
| <b>Sample call</b> | <pre> mov  ah,1 int  21h mov  char,al </pre>                                                                              |
| <b>Notes</b>       | If no character is present in the input buffer, the program waits. This function echoes the character to standard output. |

INT 21h Function 6 reads a character from standard input if the character is waiting in the input buffer. If the buffer is empty, the function returns with the Zero flag set and no other action is taken:

| INT 21h Function 6 |                                                      |
|--------------------|------------------------------------------------------|
| <b>Description</b> | Read a character from standard input without waiting |
| <b>Receives</b>    | AH = 6<br>DL = FFh                                   |

| INT 21h Function 6 |                                                                                                                                                                              |
|--------------------|------------------------------------------------------------------------------------------------------------------------------------------------------------------------------|
| <b>Returns</b>     | If ZF = 0, AL contains the character's ASCII code.                                                                                                                           |
| <b>Sample call</b> | <pre> mov  ah,6 mov  dl,0FFh int  21h jz   skip mov  char,AL skip: </pre>                                                                                                    |
| <b>Notes</b>       | The interrupt only returns a character if one is already waiting in the input buffer. Does not echo the character to standard output and does not filter control characters. |

INT 21h Function 0Ah reads a buffered string from standard input, terminated by the Enter key. When calling this function, pass a pointer to an input structure having the following format (**count** can be between 0 and 128):

```

count = 80
KEYBOARD STRUCT
    maxInput BYTE count          ; max chars to input
    inputCount BYTE ?           ; actual input count
    buffer BYTE count DUP(?)    ; holds input chars
KEYBOARD ENDS

```

The *maxInput* field specifies the maximum number of characters the user can input, including the Enter key. The backspace key can be used to erase characters and back up the cursor. The user terminates the input either by pressing the Enter key or by pressing Ctrl-Break. All non-ASCII keys, such as PageUp and F1, are filtered out and are not stored in the buffer. After the function returns, the *inputCount* field indicates how many characters were input, not counting the Enter key. The following table describes Function 0Ah:

| INT 21h Function 0Ah |                                                                                                              |
|----------------------|--------------------------------------------------------------------------------------------------------------|
| <b>Description</b>   | Read an array of buffered characters from standard input                                                     |
| <b>Receives</b>      | AH = 0Ah<br>DS:DX = address of keyboard input structure                                                      |
| <b>Returns</b>       | The structure is initialized with the input characters                                                       |
| <b>Sample call</b>   | <pre> .data kybdData KEYBOARD &lt;&gt; .code     mov  ah,0Ah     mov  dx,OFFSET kybdData     int  21h </pre> |

INT 21h Function 0Bh gets the status of the standard input buffer:

| INT 21h Function 0Bh |                                                                                     |
|----------------------|-------------------------------------------------------------------------------------|
| <b>Description</b>   | Get the status of the standard input buffer                                         |
| <b>Receives</b>      | AH = 0Bh                                                                            |
| <b>Returns</b>       | If a character is waiting, AL = 0FFh; otherwise, AL = 0                             |
| <b>Sample Call</b>   | <pre> mov  ah,0Bh int  21h cmp  al,0 je   skip ; (input the character) skip: </pre> |
| <b>Notes</b>         | Does not remove the character                                                       |

### Example: String Encryption Program

INT 21h Function 6 has the unique ability to read characters from standard input without pausing the program or filtering control characters. This can be put to good use if we run a program from the command prompt and redirect the input. That is, the input will come from a text file rather than the keyboard.

The following program (*Encrypt.asm*) reads each character from standard input, uses the XOR instruction to alter the character, and writes the altered character to standard output:

```

; Encryption Program                (Encrypt.asm)
; This program uses MS-DOS function calls to
; read and encrypt a file. Run it from the
; command prompt, using redirection:
;   Encrypt < infile.txt > outfile.txt
; Function 6 is also used for output, to avoid
; filtering ASCII control characters.

INCLUDE Irvine16.inc
XORVAL = 239                        ; any value between 0-255
.code
main PROC
    mov  ax,@data
    mov  ds,ax

L1:
    mov  ah,6                        ; direct console input
    mov  dl,0FFh                    ; don't wait for character
    int  21h                        ; AL = character
    jz   L2                          ; quit if ZF = 1 (EOF)
    xor  al,XORVAL
    mov  ah,6                        ; write to output

```

```

        mov     dl,al
        int     21h
        jmp     L1             ; repeat the loop

L2: exit
main ENDP
END main

```

The choice of 239 as the encryption value is completely arbitrary. You can use any value between 0 and 255 in this context, although using 0 will not cause any encryption to occur. The encryption is weak, of course, but it might be enough to discourage the average user from trying to defeat the encryption. When you run the program at the command prompt, indicate the name of the input file (and output file, if any). The following are two examples:

|                                                       |                                                            |
|-------------------------------------------------------|------------------------------------------------------------|
| <code>encrypt &lt; infile.txt</code>                  | Input from file (infile.txt), output to console            |
| <code>encrypt &lt; infile.txt &gt; outfile.txt</code> | Input from file (infile.txt), output to file (outfile.txt) |

### ***Int 21h Function 3Fh***

INT 21h Function 3Fh, as shown in the following table, reads an array of bytes from a file or device. It can be used for keyboard input when the device handle in BX is equal to zero:

| <b>INT 21h Function 3Fh</b> |                                                                                                                                                               |
|-----------------------------|---------------------------------------------------------------------------------------------------------------------------------------------------------------|
| <b>Description</b>          | Read an array of bytes from a file or device                                                                                                                  |
| <b>Receives</b>             | AH = 3Fh<br>BX = file/device handle (0 = keyboard)<br>CX = maximum bytes to read<br>DS:DX = address of input buffer                                           |
| <b>Returns</b>              | AX = number of bytes actually read                                                                                                                            |
| <b>Sample Call</b>          | <pre> .data inputBuffer BYTE 127 dup(0) bytesRead WORD ? .code mov  ah,3Fh mov  bx,0 mov  cx,127 mov  dx,OFFSET inputBuffer int  21h mov  bytesRead,ax </pre> |
| <b>Notes</b>                | If reading from the keyboard, input terminates when the Enter key is pressed, and the 0Dh, 0Ah, characters are appended to the input buffer                   |

If the user enters more characters than were requested by the function call, excess characters remain in the MS-DOS input buffer. If the function is called anytime later in the program, execution may not pause and wait for user input because the buffer already contains data (including the 0Dh, 0Ah, marking the end of the line). This can even occur between separate instances of program execution. To be absolutely sure your program works as intended, you need to flush the input buffer, one character at a time, after calling Function 3Fh. The following code does this (see the *Keybd.asm* program for a complete demonstration):

```

;-----
FlushBuffer PROC
; Flush the standard input buffer.
; Receives: nothing. Returns: nothing
;-----
.data
oneByte BYTE ?
.code
    pusha
L1:
    mov  ah,3Fh          ; read file/device
    mov  bx,0           ; keyboard handle
    mov  cx,1           ; one byte
    mov  dx,OFFSET oneByte ; save it here
    int  21h           ; call MS-DOS
    cmp  oneByte,0Ah   ; end of line yet?
    jne  L1            ; no: read another
    popa
    ret
FlushBuffer ENDP

```

#### 14.2.4 Date/Time Functions

Many popular software applications display the current date and time. Others retrieve the date and time and use it in their internal logic. A scheduling program, for example, can use the current date to verify that a user is not accidentally scheduling an appointment in the past.

As shown in the next series of tables, INT 21h Function 2Ah gets the system date, and INT 21h Function 2Bh sets the system date. INT 21h Function 2Ch gets the system time, and INT 21h Function 2Dh sets the system time.

| INT 21h Function 2Ah |                                                                                     |
|----------------------|-------------------------------------------------------------------------------------|
| <b>Description</b>   | Get the system date                                                                 |
| <b>Receives</b>      | AH = 2Ah                                                                            |
| <b>Returns</b>       | CX = year<br>DH, DL = month, day<br>AL = day of week (Sunday = 0, Monday = 1, etc.) |

| INT 21h Function 2Ah |                                                                                           |
|----------------------|-------------------------------------------------------------------------------------------|
| <b>Sample Call</b>   | <pre> mov ah, 2Ah int 21h mov year, cx mov month, dh mov day, dl mov dayOfWeek, al </pre> |

| INT 21h Function 2Bh |                                                                                                   |
|----------------------|---------------------------------------------------------------------------------------------------|
| <b>Description</b>   | Set the system date                                                                               |
| <b>Receives</b>      | AH = 2Bh<br>CX = year<br>DH = month<br>DL = day                                                   |
| <b>Returns</b>       | If the change was successful, AL = 0; otherwise, AL = FFh.                                        |
| <b>Sample Call</b>   | <pre> mov ah, 2Bh mov cx, year mov dh, month mov dl, day int 21h cmp al, 0 jne failed </pre>      |
| <b>Notes</b>         | Probably will not work if you are running Windows NT, 2000, or XP with a restricted user profile. |

| INT 21h Function 2Ch |                                                                                                                            |
|----------------------|----------------------------------------------------------------------------------------------------------------------------|
| <b>Description</b>   | Get the system time                                                                                                        |
| <b>Receives</b>      | AH = 2Ch                                                                                                                   |
| <b>Returns</b>       | CH = hours (0 – 23)<br>CL = minutes (0 – 59)<br>DH = seconds (0 – 59)<br>DL = hundredths of seconds (usually not accurate) |
| <b>Sample Call</b>   | <pre> mov ah, 2Ch int 21h mov hours, ch mov minutes, cl mov seconds, dh </pre>                                             |

| INT 21h Function 2Dh |                                                                                                       |
|----------------------|-------------------------------------------------------------------------------------------------------|
| <b>Description</b>   | Set the system time                                                                                   |
| <b>Receives</b>      | AH = 2Dh<br>CH = hours (0 – 23)<br>CL = minutes (0 – 59)<br>DH = seconds (0 – 59)                     |
| <b>Returns</b>       | If the change was successful, AL = 0; otherwise, AL = FFh.                                            |
| <b>Sample Call</b>   | <pre> mov  ah,2Dh mov  ch,hours mov  cl,minutes mov  dh,seconds int  21h cmp  al,0 jne  failed </pre> |
| <b>Notes</b>         | Does not work if you are running Windows with a restricted user profile.                              |

### Example: Displaying the Time and Date

The following program (*DateTime.asm*) displays the system date and time. The code is a little longer than one would expect because the program inserts leading zeros before the hours, minutes, and seconds:

```

; Display the Date and Time      (DateTime.asm)

Include Irvine16.inc
Write PROTO char:BYTE
.data
str1 BYTE "Date: ",0
str2 BYTE ", Time: ",0
.code
main PROC
    mov ax,@data
    mov ds,ax

; Display the date:
    mov dx,OFFSET str1
    call WriteString
    mov ah,2Ah                ; get system date
    int 21h
    movzx eax,dh              ; month
    call WriteDec
    INVOKE Write,'-'
    movzx eax,dl              ; day
    call WriteDec

```

```

        INVOKE Write, '-'
        movzx  eax, cx                ; year
        call  WriteDec

; Display the time:
        mov   dx, OFFSET str2
        call WriteString
        mov   ah, 2Ch                ; get system time
        int   21h
        movzx eax, ch                ; hours
        call WritePaddedDec
        INVOKE Write, ':'
        movzx eax, cl                ; minutes
        call WritePaddedDec
        INVOKE Write, ':'
        movzx eax, dh                ; seconds
        call WritePaddedDec
        call  Crlf

        exit
main ENDP

;-----
Write PROC char:BYTE
; Display a single character.
;-----
        push  eax
        push  edx
        mov   ah, 2                  ; character output function
        mov   dl, char
        int   21h
        pop   edx
        pop   eax
        ret
Write ENDP

;-----
WritePaddedDec PROC
; Display unsigned integer in EAX, padding
; to two digit positions with a leading zero.
;-----
        .IF  eax < 10
            push  eax
            push  edx
            mov   ah, 2              ; display leading zero
            mov   dl, '0'
            int   21h
            pop   edx
            pop   eax
        .ENDIF

```



```

        call WriteDec          ; write unsigned decimal
        ret                   ; using value in EAX
WritePaddedDec ENDP
END main

```

Sample output:

```
Date: 12-8-2006, Time: 23:01:23
```

### 14.2.5 Section Review

1. Which register holds the function number when calling INT 21h?
2. Which INT 21h function terminates a program?
3. Which INT 21h function writes a single character to standard output?
4. Which INT 21h function writes a string terminated by a \$ character to standard output?
5. Which INT 21h function writes a block of data to a file or device?
6. Which INT 21h function reads a single character from standard input?
7. Which INT 21h function reads a block of data from the standard input device?
8. If you want to get the system date, display it, and then change it, which INT 21h functions are required?
9. Which INT 21h functions shown in this chapter probably will not work under Windows NT, 2000, or XP with a restricted user profile?
10. Which INT 21h function would you use to check the standard input buffer to see if a character is waiting to be processed?

## 14.3 Standard MS-DOS File I/O Services

INT 21h provides more file and directory I/O services that we can possibly show here. Table 14-3 shows a few of the functions you are likely to use.

TABLE 14-3 File- and Directory-Related INT 21h Functions.

| Function | Description                     |
|----------|---------------------------------|
| 716Ch    | Create or open a file           |
| 3Eh      | Close file handle               |
| 42h      | Move file pointer               |
| 5706h    | Get file creation date and time |

*File/Device Handles* MS-DOS and MS-Windows use 16-bit integers called *handles* to identify files and I/O devices. There are five predefined device handles. Each, except handle 2 (error output), supports redirection at the command prompt. The following handles are available all the time:

|   |                                 |
|---|---------------------------------|
| 0 | Keyboard (standard input)       |
| 1 | Console (standard output)       |
| 2 | Error output                    |
| 3 | Auxiliary device (asynchronous) |
| 4 | Printer                         |

Each I/O function has a common characteristic: If it fails, the Carry flag is set, and an error code is returned in AX. You can use this error code to display an appropriate message. Table 14-4 contains a list of the error codes and their descriptions.

Microsoft provides extensive documentation on MS-DOS function calls. Search the Platform SDK documentation for your version of Windows.

TABLE 14-4 MS-DOS Extended Error Codes.

| Error Code | Description                             |
|------------|-----------------------------------------|
| 01         | Invalid function number                 |
| 02         | File not found                          |
| 03         | Path not found                          |
| 04         | Too many open files (no handles left)   |
| 05         | Access denied                           |
| 06         | Invalid handle                          |
| 07         | Memory control blocks destroyed         |
| 08         | Insufficient memory                     |
| 09         | Invalid memory block address            |
| 0A         | Invalid environment                     |
| 0B         | Invalid format                          |
| 0C         | Invalid access code                     |
| 0D         | Invalid data                            |
| 0E         | Reserved                                |
| 0F         | Invalid drive was specified             |
| 10         | Attempt to remove the current directory |
| 11         | Not same device                         |
| 12         | No more files                           |
| 13         | Diskette write-protected                |
| 14         | Unknown unit                            |
| 15         | Drive not ready                         |
| 16         | Unknown command                         |
| 17         | Data error (CRC)                        |
| 18         | Bad request structure length            |
| 19         | Seek error                              |
| 1A         | Unknown media type                      |
| 1B         | Sector not found                        |
| 1C         | Printer out of paper                    |
| 1D         | Write fault                             |
| 1E         | Read fault                              |
| 1F         | General failure                         |

### 14.3.1 Create or Open File (716Ch)

INT 21h Function 716Ch can either create a new file or open an existing file. It permits the use of extended filenames and file sharing. As shown in the following table, the filename may optionally include a directory path.

| INT 21h Function 716Ch |                                                                                                                                                                                                                                                                                                                                                                                     |
|------------------------|-------------------------------------------------------------------------------------------------------------------------------------------------------------------------------------------------------------------------------------------------------------------------------------------------------------------------------------------------------------------------------------|
| <b>Description</b>     | Create new file or open existing file                                                                                                                                                                                                                                                                                                                                               |
| <b>Receives</b>        | AX = 716Ch<br>BX = access mode (0 = read, 1 = write, 2 = read/write)<br>CX = attributes (0 = normal, 1 = read only, 2 = hidden, 3 = system, 8 = volume ID, 20h = archive)<br>DX = action (1 = open, 2 = truncate, 10h = create)<br>DS:SI = segment/offset of filename<br>DI = alias hint (optional)                                                                                 |
| <b>Returns</b>         | If the create/open was successful, CF = 0, AX = file handle, and CX = action taken. If create/open failed, CF = 1.                                                                                                                                                                                                                                                                  |
| <b>Sample Call</b>     | <pre> mov  ax,716Ch          ; extended open/create mov  bx,0              ; read-only mov  cx,0              ; normal attribute mov  dx,1              ; open existing file mov  si,OFFSET Filename int  21h jc   failed mov  handle,ax         ; file handle mov  actionTaken,cx   ; action taken           </pre>                                                                |
| <b>Notes</b>           | The access mode in BX can optionally be combined with one of the following sharing mode values: OPEN_SHARE_COMPATIBLE, OPEN_SHARE_DENYREADWRITE, OPEN_SHARE_DENYWRITE, OPEN_SHARE_DENYREAD, OPEN_SHARE_DENYNONE. The action taken returned in CX can be one of the following values: ACTION_OPENED, ACTION_CREATED_OPENED, ACTION_REPLACED_OPENED. All are defined in Irvine16.inc. |

*Additional Examples* The following code either creates a new file or truncates an existing file having the same name:

```

mov  ax,716Ch          ; extended open/create
mov  bx,2              ; read-write
mov  cx,0              ; normal attribute
mov  dx,10h + 02h     ; action: create + truncate
mov  si,OFFSET Filename
int  21h
jc   failed
mov  handle,ax         ; file handle
mov  actionTaken,cx   ; action taken to open file
          
```

The following code attempts to create a new file. It fails (with the Carry flag set) if the file already exists:

```

mov  ax,716Ch          ; extended open/create
mov  bx,2              ; read-write
mov  cx,0              ; normal attribute
mov  dx,10h           ; action: create
mov  si,OFFSET Filename
int  21h
jc   failed
mov  handle,ax         ; file handle
mov  actionTaken,cx   ; action taken to open file

```

### 14.3.2 Close File Handle (3Eh)

INT 21h Function 3Eh closes a file handle. This function flushes the file's write buffer by copying any remaining data to disk, as shown in the following table:

| INT 21h Function 3Eh |                                                                                                     |
|----------------------|-----------------------------------------------------------------------------------------------------|
| <b>Description</b>   | Close file handle                                                                                   |
| <b>Receives</b>      | AH = 3Eh<br>BX = file handle                                                                        |
| <b>Returns</b>       | If the file was closed successfully, CF = 0; otherwise, CF = 1.                                     |
| <b>Sample Call</b>   | .data<br>filehandle WORD ?<br>.code<br>mov  ah,3Eh<br>mov  bx,filehandle<br>int  21h<br>jc   failed |
| <b>Notes</b>         | If the file has been modified, its time stamp and date stamp are updated.                           |

### 14.3.3 Move File Pointer (42h)

INT 21h Function 42h, as can be seen in the following table, moves the position pointer of an open file to a new location. When calling this function, the *method code* in AL identifies how the pointer will be set:

- 0     Offset from the beginning of the file
- 1     Offset from the current location
- 2     Offset from the end of the file

| INT 21h Function 42h |                                                                                                                      |
|----------------------|----------------------------------------------------------------------------------------------------------------------|
| <b>Description</b>   | Move file pointer                                                                                                    |
| <b>Receives</b>      | AH = 42h<br>AL = method code<br>BX = file handle<br>CX:DX = 32-bit offset value                                      |
| <b>Returns</b>       | If the file pointer was moved successfully, CF = 0 and DX:AX returns the new file pointer offset; otherwise, CF = 1. |

| INT 21h Function 42h (continued) |                                                                                                                                        |
|----------------------------------|----------------------------------------------------------------------------------------------------------------------------------------|
| <b>Sample Call</b>               | <pre> mov  ah,42h mov  al,0           ; method: offset from beginning mov  bx,handle mov  cx,offsetHi mov  dx,offsetLo int  21h </pre> |
| <b>Notes</b>                     | The returned file pointer offset in DX:AX is always relative to the beginning of the file.                                             |

### 14.3.4 Get File Creation Date and Time

INT 21h Function 5706h, shown in the following table, obtains the date and time when a file was created. This is not necessarily the same date and time when the file was last modified or even accessed. To learn about MS-DOS packed date and time formats, see Section 15.3.7. To see an example of extracting date/time fields, see Section 7.3.4.

| INT 21h Function 5706h |                                                                                                                                                                                                                                         |
|------------------------|-----------------------------------------------------------------------------------------------------------------------------------------------------------------------------------------------------------------------------------------|
| <b>Description</b>     | Get file creation date and time                                                                                                                                                                                                         |
| <b>Receives</b>        | AX = 5706h<br>BX = file handle                                                                                                                                                                                                          |
| <b>Returns</b>         | If the function call was successful, CF = 0, DX = date (in MS-DOS packed format), CX = time, and SI = milliseconds. If the function failed, CF = 1.                                                                                     |
| <b>Sample Call</b>     | <pre> mov  ax,5706h           ; Get creation date/time mov  bx,handle int  21h jc   error             ; quit if failed mov  date,dx mov  time,cx mov  milliseconds,si </pre>                                                            |
| <b>Notes</b>           | The file must already be open. The <i>milliseconds</i> value indicates the number of 10-millisecond intervals to add to the MS-DOS time. Range is 0 to 199, indicating that the field can add as many as 2 seconds to the overall time. |

### 14.3.5 Selected Library Procedures

Two procedures from the Irvine16 link library are shown here: **ReadString** and **WriteString**. **ReadString** is the trickiest of the two, since it must read one character at a time until it encounters the end of line character (0Dh). It reads the character, but does not copy it to the buffer.

#### **ReadString**

The **ReadString** procedure reads a string from standard input and places the characters in an input buffer as a null-terminated string. It terminates when the user presses the Enter key.:

```

;-----
ReadString PROC
; Receives: DS:DX points to the input buffer,
;           CX = maximum input size

```

```

; Returns:  AX = size of the input string
; Comments: Stops when the Enter key (0Dh) is pressed.
;-----
        push  cx                ; save registers
        push  si
        push  cx                ; save digit count again
        mov   si,dx             ; point to input buffer
L1:     mov   ah,1               ; function: keyboard input
        int  21h                ; returns character in AL
        cmp  al,0Dh             ; end of line?
        je   L2                 ; yes: exit
        mov  [si],al            ; no: store the character
        inc  si                 ; increment buffer pointer
        loop L1                 ; loop until CX=0

L2:     mov  byte ptr [si],0     ; end with a null byte
        pop  ax                 ; original digit count
        sub  ax,cx              ; AX = size of input string
        pop  si                 ; restore registers
        pop  cx
        ret
ReadString ENDP

```

### WriteString

The **WriteString** procedure writes a null-terminated string to standard output. It calls a helper procedure named **Str\_length** that returns the number of bytes in a string:

```

;-----
WriteString PROC
; Writes a null-terminated string to standard output
; Receives: DS:DX = address of string
; Returns:  nothing
;-----
        pusha
        push  ds                ; set ES to DS
        pop  es
        mov  di,dx              ; ES:DI = string ptr
        call Str_length         ; AX = string length
        mov  cx,ax              ; CX = number of bytes
        mov  ah,40h            ; write to file or device
        mov  bx,1               ; standard output handle
        int  21h                ; call MS-DOS
        popa
        ret
WriteString ENDP

```

#### 14.3.6 Example: Read and Copy a Text File

We presented INT 21h Function 3Fh earlier in this chapter, in the context of reading from standard input. This function can also be used to read a file if the handle in BX identifies a file that has been opened for input. When Function 3Fh returns, AX indicates the number of bytes

actually read from the file. When the end of the file is reached, the value returned in AX is less than the number of bytes requested (in CX).

We also presented INT 21h Function 40h earlier in this chapter in the context of writing to standard output (device handle 1). Instead, the handle in BX can refer to an open file. The function automatically updates the file's position pointer, so the next call to Function 40h begins writing where the previous call left off.

The *Readfile.asm* program we're about to present demonstrates several INT 21h functions presented in this section:

- Function 716Ch: Create new file or open existing file
- Function 3Fh: Read from file or device
- Function 40h: Write to file or device
- Function 3Eh: Close file handle

The following program opens a text file for input, reads no more than 5,000 bytes from the file, displays it on the console, creates a new file, and copies the data to a new file:

```

; Read a text file          (Readfile.asm)

; Read, display, and copy a text file.
INCLUDE Irvine16.inc

.data
BufSize = 5000
infile   BYTE "my_text_file.txt",0
outfile  BYTE "my_output_file.txt",0
inHandle WORD ?
outHandle WORD ?
buffer   BYTE BufSize DUP(?)
bytesRead WORD ?

.code
main PROC
    mov  ax,@data
    mov  ds,ax

; Open the input file
    mov  ax,716Ch          ; extended create or open
    mov  bx,0              ; mode = read-only
    mov  cx,0              ; normal attribute
    mov  dx,1              ; action: open
    mov  si,OFFSET infile
    int  21h               ; call MS-DOS
    jc   quit              ; quit if error
    mov  inHandle,ax

; Read the input file
    mov  ah,3Fh            ; read file or device
    mov  bx,inHandle       ; file handle
    mov  cx,BufSize        ; max bytes to read
    mov  dx,OFFSET buffer  ; buffer pointer
    int  21h

```

```

        jc    quit                ; quit if error
        mov   bytesRead,ax
; Display the buffer
        mov   ah,40h              ; write file or device
        mov   bx,1                ; console output handle
        mov   cx,bytesRead        ; number of bytes
        mov   dx,OFFSET buffer    ; buffer pointer
        int   21h
        jc    quit                ; quit if error
; Close the file
        mov   ah,3Eh              ; function: close file
        mov   bx,inHandle         ; input file handle
        int   21h                 ; call MS-DOS
        jc    quit                ; quit if error
; Create the output file
        mov   ax,716Ch            ; extended create or open
        mov   bx,1                ; mode = write-only
        mov   cx,0                ; normal attribute
        mov   dx,12h              ; action: create/truncate
        mov   si,OFFSET outfile
        int   21h                 ; call MS-DOS
        jc    quit                ; quit if error
        mov   outHandle,ax        ; save handle
; Write buffer to new file
        mov   ah,40h              ; write file or device
        mov   bx,outHandle        ; output file handle
        mov   cx,bytesRead        ; number of bytes
        mov   dx,OFFSET buffer    ; buffer pointer
        int   21h
        jc    quit                ; quit if error
; Close the file
        mov   ah,3Eh              ; function: close file
        mov   bx,outHandle        ; output file handle
        int   21h                 ; call MS-DOS
quit:
        call  Crlf
        exit
main ENDP
END main

```

### 14.3.7 Reading the MS-DOS Command Tail

In the programs that follow, we will often pass information to programs on the command line. Suppose we needed to pass the name *file1.doc* to a program named *attr.exe*. The MS-DOS command line would be

```
attr file1.doc
```

When a program starts up, any additional text on its command line is automatically stored in the 128-byte *MS-DOS Command Tail* located in memory at offset 80h from the beginning of the



segment address specified by the ES register. The memory area is named the *program segment prefix* (PSP). The program segment prefix is discussed in Section 17.3.1. Also see Section 2.3.1 for a discussion of how segmented addressing works in real-address mode.

The first byte contains the length of the command line. If its value is greater than zero, the second byte contains a space character. The remaining bytes contain the text typed on the command line. Using the example command line for the *attr.exe* program, the hexadecimal contents of the command tail would be the following:

|       |                        |
|-------|------------------------|
|       | Software BIOS          |
| 00400 | BIOS & DOS Data        |
| 00000 | Interrupt Vector Table |

There is one exception to the rule that MS-DOS stores all characters after the command or program name: It doesn't keep the file and device names used when redirecting input–output. For example, MS-DOS does not save any text in the command tail when the following command is typed because both *infile.txt* and PRN are used for redirection:

```
prog1 < infile.txt > prn
```

**GetCommandTail Procedure** The **GetCommandTail** procedure from the Irvine16 library returns a copy of the running program's command tail under MS-DOS. When calling this procedure, set DX to the offset of the buffer where the command tail will be copied. Real-address mode programs often deal directly with segment registers so they can access data in different memory segments. For example, **GetCommandTail** saves the current value of ES on the stack, obtains the PSP segment using INT 21h Function 62h and copies it to ES:

```
push es
.
.
mov ah,62h                ; get PSP segment address
int 21h                   ; returned in BX
mov es,bx                 ; copied to ES
```

Next, it locates a byte inside the PSP. Because ES does not point to the program's default data segment, we must use a *segment override* (es:) to address data inside the program segment prefix:

```
mov cl,es:[di-1]         ; get length byte
```

**GetCommandTail** skips over leading spaces with SCASB and sets the Carry flag if the command tail is empty. This makes it easy for the calling program to execute a JC (*jump carry*) instruction if nothing is typed on the command line:

```
cld                       ; scan in forward direction
mov al,20h                ; space character
repz scasb                ; scan for non space
```

```

        jz     L2                ; all spaces found
        .
        .
L2:    stc                      ; CF=1 means no command tail

```

SCASB automatically scans memory pointed to by the ES segment registers, so we had no choice but to set ES to the PSP segment at the beginning of GetCommandTail. Here's a complete listing:

```

;-----
GetCommandTail PROC
;
; Gets a copy of the MS-DOS command tail at PSP:80h.
; Receives: DX contains the offset of the buffer
;           that receives a copy of the command tail.
; Returns: CF=1 if the buffer is empty; otherwise,
;          CF=0.
;-----
SPACE = 20h
        push es
        pusha                    ; save general registers
        mov  ah,62h              ; get PSP segment address
        int  21h                ; returned in BX
        mov  es,bx              ; copied to ES

        mov  si,dx              ; point to buffer
        mov  di,81h            ; PSP offset of command tail
        mov  cx,0               ; byte count
        mov  cl,es:[di-1]      ; get length byte
        cmp  cx,0              ; is the tail empty?
        je   L2                 ; yes: exit
        cld                     ; scan in forward direction
        mov  al,SPACE          ; space character
        repz scasb              ; scan for non space
        jz   L2                 ; all spaces found
        dec  di                ; non space found
        inc  cx

```

By default, the assembler assumes that DI is an offset from the segment address in DS. The segment override ( es:[di] ) tells the CPU to use the segment address in ES instead.

```

L1:    mov  al,es:[di]          ; copy tail to buffer
        mov  [si],al           ; pointed to by DS:SI
        inc  si
        inc  di
        loop L1
        clc                    ; CF=0 means tail found
        jmp  L3

L2:    stc                      ; CF=1 means no command tail
L3:    mov  byte ptr [si],0    ; store null byte

```

```

        popa                ; restore registers
        pop  es
        ret
GetCommandTail ENDP

```

### 14.3.8 Example: Creating a Binary File

A *binary file* is given its name because the data stored in the file is simply a binary image of program data. Suppose, for example, that your program created and filled an array of doublewords:

```
myArray DWORD 50 DUP(?)
```

If you wanted to write this array to a text file, you would have to convert each integer to a string and write it separately. A more efficient way to store this data would be to just write a binary image of **myArray** to a file. An array of 50 doublewords uses 200 bytes of memory, and that is exactly the amount of disk space the file would use.

The following *Binfile.asm* program fills an array with random integers, displays the integers on the screen, writes the integers to a binary file, and closes the file. It reopens the file, reads the integers, and displays them on the screen:

```

; Binary File Program          (Binfile.asm)
; This program creates a binary file containing
; an array of doublewords. It then reads the file
; back in and displays the values.

INCLUDE Irvine16.inc

.data
myArray DWORD 50 DUP(?)

fileName  BYTE "binary array file.bin",0
fileHandle WORD ?
commaStr  BYTE ", ",0

; Set CreateFile to zero if you just want to
; read and display the existing binary file.
CreateFile = 1

.code
main PROC
    mov  ax,@data
    mov  ds,ax

    .IF CreateFile EQ 1
        call  FillTheArray
        call  DisplayTheArray
        call  CreateTheFile
        call  WaitMsg
        call  Crlf
    .ENDIF
    call  ReadTheFile
    call  DisplayTheArray

```

```

quit:
    call Crlf
    exit
main ENDP

;-----
ReadTheFile PROC
;
; Open and read the binary file.
; Receives: nothing.
; Returns: nothing
;-----
    mov     ax,716Ch           ; extended file open
    mov     bx,0              ; mode: read-only
    mov     cx,0              ; attribute: normal
    mov     dx,1              ; open existing file
    mov     si,OFFSET fileName ; filename
    int     21h               ; call MS-DOS
    jc     quit               ; quit if error
    mov     fileHandle,ax     ; save handle

; Read the input file, then close the file.
    mov     ah,3Fh           ; read file or device
    mov     bx,fileHandle    ; file handle
    mov     cx,SIZEOF myArray ; max bytes to read
    mov     dx,OFFSET myArray ; buffer pointer
    int     21h
    jc     quit               ; quit if error
    mov     ah,3Eh           ; function: close file
    mov     bx,fileHandle    ; output file handle
    int     21h               ; call MS-DOS

quit:
    ret
ReadTheFile ENDP

;-----
DisplayTheArray PROC
;
; Display the doubleword array.
; Receives: nothing.
; Returns: nothing
;-----
    mov     CX,LENGTHOF myArray
    mov     si,0

L1:
    mov     eax,myArray[si]   ; get a number
    call    WriteHex          ; display the number
    mov     edx,OFFSET commaStr ; display a comma
    call    WriteString
    add     si,TYPE myArray   ; next array position
    loop   L1
    ret

```

```

DisplayTheArray ENDP
;-----
FillTheArray PROC
;
; Fill the array with random integers.
; Receives: nothing.
; Returns: nothing
;-----
    mov     CX,LENGTHOF myArray
    mov     si,0
L1:
    mov     eax,1000                ; generate random integers
    call    RandomRange             ; between 0 - 999 in EAX
    mov     myArray[si],eax         ; store in the array
    add     si,TYPE myArray         ; next array position
    loop   L1
    ret
FillTheArray ENDP
;-----
CreateTheFile PROC
;
; Create a file containing binary data.
; Receives: nothing.
; Returns: nothing
;-----
    mov     ax,716Ch                ; create file
    mov     bx,1                    ; mode: write only
    mov     cx,0                    ; normal file
    mov     dx,12h                  ; action: create/truncate
    mov     si,OFFSET fileName      ; filename
    int     21h                    ; call MS-DOS
    jc     quit                    ; quit if error
    mov     fileHandle,ax           ; save handle

; Write the integer array to the file.
    mov     ah,40h                  ; write file or device
    mov     bx,fileHandle           ; output file handle
    mov     cx,SIZEOF myArray       ; number of bytes
    mov     dx,OFFSET myArray       ; buffer pointer
    int     21h
    jc     quit                    ; quit if error

; Close the file.
    mov     ah,3Eh                  ; function: close file
    mov     bx,fileHandle           ; output file handle
    int     21h                    ; call MS-DOS

quit:
    ret
CreateTheFile ENDP
END main

```

It is worth noting that writing the entire array is done with a single call to INT 21h Function 40h. There is no need for a loop:

```
mov ah,40h                ; write file or device
mov bx,fileHandle        ; output file handle
mov cx,SIZEOF myArray    ; number of bytes
mov dx,OFFSET myArray    ; buffer pointer
int 21h
```

The same is true when reading the file back into the array. A single call to INT 21h Function 3Fh does the job:

```
mov ah,3Fh                ; read file or device
mov bx,fileHandle        ; file handle
mov cx,SIZEOF myArray    ; max bytes to read
mov dx,OFFSET myArray    ; buffer pointer
int 21h
```

### 14.3.9 Section Review

1. Name the five standard MS-DOS device handles.
2. After calling an MS-DOS I/O function, which flag indicates that an error has occurred?
3. When you call Function 716Ch to create a file, what arguments are required?
4. Show an example of opening an existing file for input.
5. When you call Function 716Ch to read a binary array from a file that is already open, what argument values are required?
6. How do you check for end of file when reading an input file using INT 21h Function 3Fh?
7. When calling Function 3Fh, how is reading from a file different from reading from the keyboard?
8. If you wanted to read a random-access file, which INT 21h function would permit you to jump directly to a particular record in the middle of the file?
9. Write a short code segment that positions the file pointer 50 bytes from the beginning of a file. Assume that the file is already open, and BX contains the file handle.

## 14.4 Chapter Summary

In this chapter, you learned the basic memory organization of MS-DOS, how to activate MS-DOS function calls, and how to perform basic input–output operations at the operating system level.

The standard input device and the standard output device are collectively called the *console*, which involves the keyboard for input and the video display for output.

A *software interrupt* is a call to an operating system procedure. Most of these procedures, called *interrupt handlers*, provide input–output capability to application programs.

The INT (call to interrupt procedure) instruction pushes the CPU flags and 32-bit return address (CS and IP) on the stack, disables other interrupts, and calls an interrupt handler. The CPU processes the INT instruction using the *interrupt vector table*, a table containing 32-bit segment–offset addresses of interrupt handlers.

Programs designed for MS-DOS must be 16-bit applications running in real-address mode. Real-address mode applications use 16-bit segments and use segmented addressing.

The `.MODEL` directive specifies which memory model your program will use. The `.STACK` directive allocates a small amount of local stack space for your program. In real-address mode, stack entries are 16 bits by default. Enable the use of 32-bit registers using the `.386` directive.

A 16-bit application containing variables must set `DS` to the location of the data segment before accessing the variables.

Every program must include a statement that ends the program and returns to the operating system. One way to do this is by using the `.EXIT` directive. Another way is by calling `INT 21h` Function `4Ch`.

Any real-address mode program can access hardware ports, interrupt vectors, and system memory when running under MS-DOS, and early version of Windows. and early version of Windows. On the other hand, this type of access is only granted to kernel mode and device driver programs in more recent versions of Windows.

When a program runs, any additional text on its command line is automatically stored in the 128-byte MS-DOS command tail area, at offset `80h` in special memory segment named the *program segment prefix* (PSP). The `GetCommandTail` procedure from the `Irvine16` library returns a copy of the command tail.

Some frequently used BIOS interrupts are listed here:

- `INT 10h` Video Services: Procedures that display routines that control the cursor position, write text in color, scroll the screen, and display video graphics.
- `INT 16h` Keyboard Services: Procedures that read the keyboard and check its status.
- `INT 17h` Printer Services: Procedures that initialize, print, and return the printer status.
- `INT 1Ah` Time of Day: A procedure that gets the number of clock ticks since the machine was turned on or sets the counter to a new value.
- `INT 1Ch` User Timer Interrupt: An empty procedure that is executed 18.2 times per second.

A number of important MS-DOS (`INT 21h`) functions are listed here:

- `INT 21h` MS-DOS Services: Procedures that provide input–output, file handling, and memory management. Also known as MS-DOS function calls.
- About 200 different functions are supported by `INT 21h`, identified by a function number placed in the `AH` register.
- `INT 21h` Function `4Ch` terminates the current program (called a process).
- `INT 21h` Functions `2` and `6` write a single character to standard output.
- `INT 21h` Function `5` writes a single character to the printer.
- `INT 21h` Function `9` writes a string to standard output.
- `INT 21h` Function `40h` writes an array of bytes to a file or device.
- `INT 21h` Function `1` reads a single character from standard input.
- `INT 21h` Function `6` reads a character from standard input without waiting.
- `INT 21h` Function `0Ah` reads a buffered string from standard input.
- `INT 21h` Function `0Bh` gets the status of the standard input buffer.

- INT 21h Function 3Fh reads an array of bytes from a file or device.
- INT 21h Function 2Ah gets the system date.
- INT 21h Function 2Bh sets the system date.
- INT 21h Function 2Ch gets the system time.
- INT 21h Function 2Dh sets the system time.
- INT 21h Function 716Ch either creates a file or opens an existing file.
- INT 21h Function 3Eh closes a file handle.
- INT 21h Function 42h moves a file's position pointer.
- INT 21h Function 5706h obtains a file's creation date and time.
- INT 21h Function 62h returns the segment portion of the program segment prefix address.

The following sample programs showed how to apply MS-DOS functions:

- The *DateTime.asm* program displays the system date and time.
- The *Readfile.asm* program opens a text file for input, reads the file, displays it on the console, creates a new file, and copies the data to a new file.
- The *Binfile.asm* program fills an array with random integers, displays the integers on the screen, writes the integers to a binary file, and closes the file. It reopens the file, reads the integers, and displays them on the screen.

A binary file is given its name because the data stored in the file is a binary image of program data.

## 14.5 Programming Exercises

The following exercises must be done in real-address mode. Do not use any functions from the Irvine16 library. Use INT 21h function calls for all input–output, unless an exercise specifically says to do otherwise.

### ★★ 1. Read a Text File

Open a file for input, read the file, and display its contents on the screen in hexadecimal. Make the input buffer small—about 256 bytes—so the program uses a loop to repeat the call to Function 3Fh as many times as necessary until the entire file has been processed.

### ★★ 2. Copy a Text File

Modify the **Readfile** program in Section 14.3.6 so that it can read a file of any size. Assuming that the buffer is smaller than the input file, use a loop to read all data. Use a buffer size of 256 bytes. Display appropriate error messages if the Carry flag is set after any INT 21h function calls.

### ★ 3. Setting the Date

Write a program that displays the current date and prompts the user for a new date. If a nonblank date is entered, use it to update the system date.

### ★ 4. Uppercase Conversion

Write a program that uses INT 21h to input lowercase letters from the keyboard and convert them to uppercase. Display only the uppercase letters.



**★ 5. File Creation Date**

Write a procedure that displays the date when a file was created, along with its filename. Pass a pointer to the filename in the DX register. Write a test program that demonstrates the procedure with several different filenames, including extended filenames. If a file cannot be found, display an appropriate error message.

**★★★ 6. Text Matching Program**

Write a program that opens a text file containing up to 60K bytes and performs a case-insensitive search for a string. The string and the filename can be input by the user. Display each line from the file on which the string appears and prefix each line with a line number. Review the **Str\_find** procedure from the programming exercises in Section 9.7. Your program must run in real-address mode.

**★★ 7. File Encryption Using XOR**

Enhance the file encryption program from Section 6.3.4 as follows:

- Prompt the user for the name of a plaintext file and a ciphertext file.
- Open the plaintext file for input, and open the cipher text file for output.
- Let the user enter a single integer encryption code (1 to 255).
- Read the plaintext file into a buffer, and exclusive-OR each byte with the encryption code.
- Write the buffer to the ciphertext file.

The only procedure you may call from the book's link library is **ReadInt**. All other input/output must be performed using INT 21h. The same code you write could also be used to decrypt the ciphertext file, producing the original plaintext file.

**★★★ 8. CountWords Procedure**

Write a program that counts the words in a text file. Prompt the user for a file name, and display the word count on the screen. The only procedure you may call from the book's link library is **WriteDec**. All other input/output must be performed using INT 21h.

---

# Disk FUNDAMENTALS

- 15.1 Disk Storage Systems
  - 15.1.1 Tracks, Cylinders, and Sectors
  - 15.1.2 Disk Partitions (Volumes)
  - 15.1.3 Section Review
- 15.2 File Systems
  - 15.2.1 FAT12
  - 15.2.2 FAT16
  - 15.2.3 FAT32
  - 15.2.4 NTFS
  - 15.2.5 Primary Disk Areas
  - 15.2.6 Section Review
- 15.3 Disk Directory
  - 15.3.1 MS-DOS Directory Structure
  - 15.3.2 Long Filenames in MS-Windows
  - 15.3.3 File Allocation Table (FAT)
  - 15.3.4 Section Review
- 15.4 Reading and Writing Disk Sectors
  - 15.4.1 Sector Display Program
  - 15.4.2 Section Review
- 15.5 System-Level File Functions
  - 15.5.1 Get Disk Free Space (7303h)
  - 15.5.2 Create Subdirectory (39h)
  - 15.5.3 Remove Subdirectory (3Ah)
  - 15.5.4 Set Current Directory (3Bh)
  - 15.5.5 Get Current Directory (47h)
  - 15.5.6 Get and Set File Attributes (7143h)
  - 15.5.7 Section Review
- 15.6 Chapter Summary
- 15.7 Programming Exercises

We recommend that you install an early version of Windows such as Windows 95 or Windows 98 to insure full compatibility with the programs in this chapter. You may want to use a software utility to create a virtual machine on your computer, so you can experiment with this software.

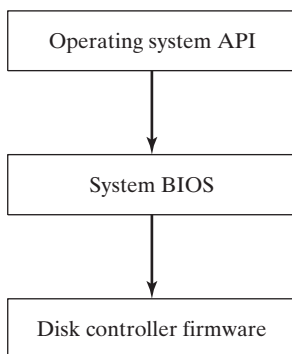
## 15.1 Disk Storage Systems

In this chapter, we introduce the basics of disk storage systems. We also show how disk storage relates to the BIOS-level disk storage in legacy versions of Windows, and we show how MS-Windows interacts with application programs to provide access to files and directories. The system BIOS was first mentioned in Section 2.5. The interaction between a computer's different layers of input-output access is readily apparent when you consider disk storage (Fig. 15-1):

- At the lowest layer is the *disk controller firmware*, which uses intelligent controller chips to map out the disk geometry (physical locations) for specific disk drive brands and models.

- At the next layer is the *system BIOS*, which provides a low-level collection of functions that operating systems use to perform tasks such as sector reads, sector writes, and track formatting.
- At the next highest layer is the *operating system API*, which provides a collection of API functions that provides services such as opening and closing files, setting file properties, reading files, and writing files.

FIGURE 15-1 Virtual levels of disk access.



Disk storage systems all have certain common characteristics: They handle physical partitioning of data and access to data at the file level, and they map filenames to physical storage. At the hardware level, disk storage is described in terms of platters, sides, tracks, cylinders, and sectors. At the system BIOS level, disk storage is described in terms of clusters and sectors. At the OS level, disk storage is described in terms of directories and files.

**Assembly Language Programs** User-level programs written in assembly language can directly access the system BIOS under MS-DOS, Windows 95, 98, and Millennium. For example, you might want to store and retrieve data stored in an unconventional format, to recover lost data, or to perform diagnostics on disk hardware. In this chapter, we show examples of system-BIOS file and sector functions. As an illustration of typical OS-level access to data, a number of MS-DOS functions for drive and directory manipulation are listed at the end of the chapter.

If you're using recent 32-bit versions of Windows, user-level programs can only access the disk system using the Win32 API. That rule safeguards system security, and can only be bypassed by device driver programs running at the highest privilege level.

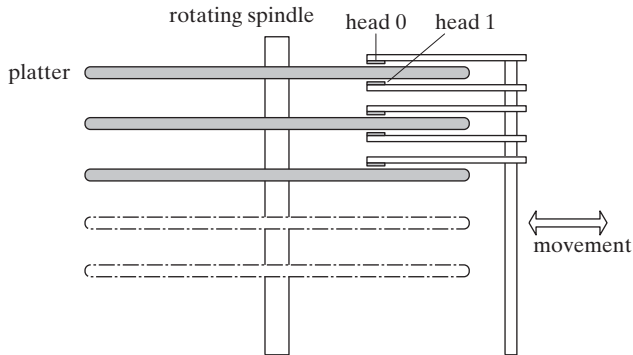
### 15.1.1 Tracks, Cylinders, and Sectors

A typical hard drive, shown in Fig. 15-2, is made up of multiple platters attached to a spindle that rotates at constant speed. Above the surface of each platter is a read/write head that records magnetic pulses. The read/write heads move in toward the center and out toward the rim as a group, in small steps.

The surface of a disk is formatted into invisible concentric bands called *tracks* on which data is stored magnetically. A typical 3.5" hard drive may contain thousands of tracks. Moving the read/write heads from one track to another is called *seeking*. The *average seek time* is one type of disk speed measurement. Another measurement is RPM (revolutions per minute), typically 7200. The outside track of a disk is track 0, and the track numbers increase as you move toward the center.

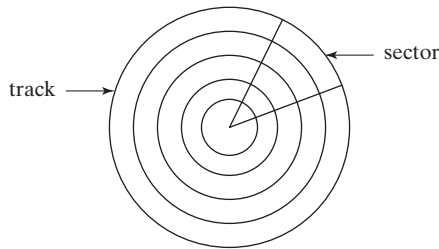
A *cylinder* refers to all tracks accessible from a single position of the read/write heads. A file is initially stored on a disk using adjacent cylinders. This reduces the amount of movement by the read/write heads.

FIGURE 15-2 Physical elements of a hard drive.



A *sector* is a 512-byte portion of a track, as shown in Fig. 15-3. Physical sectors are magnetically (invisibly) marked on the disk by the manufacturer, using what is called a *low-level format*. Sector sizes never change, regardless of the installed operating system. A hard disk may have 63 or more sectors per track

FIGURE 15-3 Disk tracks and sectors.



*Physical disk geometry* is a way of describing the disk's structure to make it readable by the system BIOS. It consists of the number of cylinders per disk, the number of read/write heads per cylinder, and the number of sectors per track. The following relationships exist:

- The number of cylinders per disk equals the number of tracks per surface.
- The total number of tracks equals the number of cylinders times the number of heads per cylinder.

**Fragmentation** Over time, as files become more spread out around a disk, they become fragmented. A *fragmented* file is one whose sectors are no longer located in contiguous areas of the disk. When this happens, the read/write heads have to skip across tracks when reading the file's data. This slows down the reading and writing of files.

**Translation to Logical Sector Numbers** Hard disk controllers perform a process called *translation*, the conversion of physical disk geometry to a logical structure that is understood by the operating system. The controller is usually embedded in firmware, either on the drive itself or on a separate controller card. After translation, the operating system can work with what are called *logical sector numbers*. Logical sector numbers are always numbered sequentially, starting at zero.

### 15.1.2 Disk Partitions (Volumes)

Under MS-Windows, a single physical hard drive can be divided into one or more logical units named *partitions*, or *volumes*. Each formatted partition is represented by a separate drive letter such as C, D, or E, and it can be formatted using one of several file systems. A drive may contain two types of partitions: primary and extended.

A primary partition is usually bootable and holds an operating system. An *extended partition* can be divided into an unlimited number of *logical partitions*. Each logical partition is mapped to a drive letter (C, D, E, etc.). Logical partitions cannot be bootable. It is possible to format each system or logical partition with a different file system.

Suppose, for example, that a 20 GByte hard drive was assigned a primary 10 GByte partition (drive C), and we installed the operating system on it. Its extended partition would be 10 GByte. Arbitrarily, we could divide the latter into two logical partitions of 2 GByte and 8 GByte and format them with various file systems such as FAT16, FAT32, or NTFS. (We will discuss the details of these file systems in the next section of this chapter.) Assuming that no other hard drives were already installed, the two logical partitions would be assigned drive letters D and E.

**Multi-boot Systems** It is quite common to create multiple primary partitions, each capable of booting (loading) a different operating system. This makes it possible to test software in different environments and to take advantage of security features in the more advanced systems. Before virtualization software was widely available, software developers could use a primary partition to create a test environment for software under development. Then they could retain another primary partition that holds production software that has already been tested and is ready for use by customers.

Logical partitions, on the other hand, are primarily intended for data. It is possible for different operating systems to share data stored in the same logical partition. For example, all recent versions of MS-Windows and Linux can read FAT32 disks. A computer can boot from any of these operating systems and read the same data files in a shared logical partition.

**Tools:** You can use the FDISK.EXE program under MS-DOS and Windows 98 to create and remove partitions, but it does not preserve data. Better yet, recent versions of Windows have a Disk Manager utility that provides the ability to create, delete, and resize partitions without destroying data.

**Master Boot Record** The Master Boot Record (MBR), created when the first partition is created on a hard disk, is located in the drive's first logical sector. The MBR contains the following:

- The disk *partition table*, which describes the sizes and locations of all partitions on the disk.
- A small program that locates the partition's boot sector and transfers control to a program in the sector that loads the operating system.

### 15.1.3 Section Review

1. (*True/False*): A track is divided into multiple units called *sectors*.
2. (*True/False*): A sector consists of multiple tracks.
3. A \_\_\_\_\_ consists of all tracks accessible from a single position of the read/write heads of a hard drive.

4. (*True/False*): Physical sectors are always 512 bytes because the sectors are marked on the disk by the manufacturer.
5. Under FAT32, how many bytes are used by a logical sector?
6. Why are files initially stored in adjacent cylinders?
7. When a file's storage becomes fragmented, what does this mean in terms of cylinders and *seek* operations performed by the drive?
8. Another name for a drive partition is a drive \_\_\_\_\_.
9. What does a drive's *average seek time* measure?
10. What is a *low-level format*?
11. What is contained in the *master boot record*?
12. How many primary partitions can be active at the same time?
13. When a primary partition is active, it is called the \_\_\_\_\_ partition.

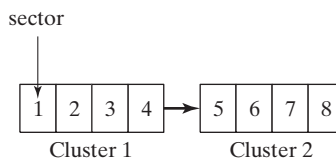
## 15.2 File Systems

Every operating system has some type of disk management system. At the lowest level, it manages partitions. At the next-highest level, it manages files and directories. A file system must keep track of the location, sizes, and attributes of each disk file. Let's take a look at the FAT-type file system originally created for the IBM-PC, and still available under Windows. A FAT-type file system uses the following structure:

- A mapping of logical sectors to *clusters*, the basic unit of storage for all files and directories.
- A mapping of file and directory names to sequences of clusters.

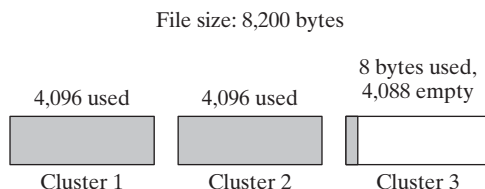
A *cluster* is the smallest unit of space used by a file; it consists of one or more adjacent disk sectors. A file system stores each file as a linked sequence of clusters. The size of a cluster depends on both the type of file system in use and the size of its disk partition. Figure 15-4 shows a file made up of two 2048-byte clusters, each containing four 512-byte sectors. A chain of clusters is referenced by a *file allocation table* (FAT) that keeps track of all clusters used by a file. A pointer to the first cluster entry in the FAT is stored in each file's directory entry. Section 15.3.2 explains the FAT in greater detail.

FIGURE 15-4 Cluster chain example.



**Wasted Space** Even a small file requires at least one cluster of disk storage, which can result in wasted space. Figure 15-5 shows an 8200-byte file, which completely fills two 4096-byte clusters and uses only 8 bytes of a third cluster. This leaves 4088 bytes of wasted disk space in the third cluster. A cluster size of 4096 (4 KByte) is considered an efficient way to store small files. Imagine what would result if our 8200-byte file were stored on a volume having 32 KByte clusters. In that case, 24568 bytes (32768 – 8200) would be wasted. On volumes having a large number of small files, small cluster sizes are best.

FIGURE 15-5 Cluster chain showing wasted space.



**Windows 2000/XP Example** Standard cluster sizes and file system types for hard drives used under Windows 2000 and Windows XP are shown in Table 15-1. These values change often with new operating system releases, so the information shown here is for illustrative purposes only.

TABLE 15-1 Partition and Cluster Sizes (Over 1 GByte).

| Volume Size        | FAT16 Cluster               | FAT32 Cluster   | NTFS Cluster <sup>a</sup> |
|--------------------|-----------------------------|-----------------|---------------------------|
| 1.25 GByte–2 GByte | 32 KByte                    | 4 KByte         | 2 KByte                   |
| 2 GByte–4 GByte    | 64 KByte <sup>b</sup>       | 4 KByte         | 4 KByte                   |
| 4 GByte–8 GByte    | ns ( <i>not supported</i> ) | 4 KByte         | 4 KByte                   |
| 8 GByte–16 GByte   | ns                          | 8 KByte         | 4 KByte                   |
| 16 GByte–32 GByte  | ns                          | 16 KByte        | 4 KByte                   |
| 32 GByte–2 TByte   | ns                          | ns <sup>c</sup> | 4 KByte                   |

<sup>a</sup> Default sizes under NTFS. Can be changed when disk is formatted.

<sup>b</sup> 64 KByte clusters with FAT16 are only supported by Windows 2000 and XP.

<sup>c</sup> A software patch is available that permits Windows 98 to format drives over 32 GByte.

### 15.2.1 FAT12

The FAT12 file system was first used on IBM-PC diskettes. It is still supported by all versions of MS-Windows and Linux. The cluster size is only 512 bytes, so it is ideal for storing small files. Each entry in its file allocation table is 12 bits long. A FAT12 volume holds fewer than 4087 clusters.

### 15.2.2 FAT16

The FAT16 file system is the only available format for hard drives formatted under MS-DOS. It is supported by all versions of MS-Windows and Linux. There are some drawbacks to FAT16:

- Storage is inefficient on volumes over 1 GByte because FAT16 uses large cluster sizes.
- Each entry in the file allocation table is 16 bits long, limiting the total number of clusters.
- The volume can hold between 4087 and 65,526 clusters.
- The boot sector is not backed up, so a single sector read error can be catastrophic.
- There is no built-in file system security or individual user permissions.

### 15.2.3 FAT32

The FAT32 file system was introduced with Windows 95, and was refined under Windows 98. It has a number of improvements over FAT16:

- A single file can be as large as 4 GBytes minus 2 bytes.
- Each entry in the file allocation table is 32 bits long.
- A volume can hold between 65,526 and 268,435,456 clusters.
- The root folder can be located anywhere on the disk, and it can be almost any size.

- Volumes can hold up to 32 GBytes.
- It uses a smaller cluster size than FAT16 on volumes holding 1 GByte to 8 GByte, resulting in less wasted space.
- The boot record includes a backup copy of critical data structures. This means that FAT32 drives are less susceptible to a single point of failure than FAT16 drives.

#### 15.2.4 NTFS

The NTFS file system is supported by all recent versions of Windows. It has significant improvements over FAT32:

- NTFS handles large volumes, which can be either on a single hard drive or spanned across multiple hard drives.
- The default cluster size is 4 KBytes for disks over 2 GBytes.
- Supports Unicode filenames (non-ANSI characters) up to 255 characters long.
- Allows the setting of permissions on files and folders. Access can be by individual users or groups of users. Different levels of access are possible (read, write, modify, etc.)
- Provides built-in data encryption and compression on files, folders, and volumes.
- Can track individual changes to files over time in a *change journal*.
- Disk quotas can be set for individual users or groups of users.
- Provides robust recovery from data errors. Automatically repairs errors by keeping a transaction log.
- Supports disk mirroring, in which the same data are simultaneously written to multiple drives.

Table 15-2 lists each of the different file systems commonly used on Intel-based computers, showing their support by various operating systems.

Table 15-2 Operating System Support for File Systems.

| File System | MS-DOS | Linux | Win 95/98 | Win NT 4 | Win 2000 Onward |
|-------------|--------|-------|-----------|----------|-----------------|
| FAT12       | X      | X     | X         | X        | X               |
| FAT16       | X      | X     | X         | X        | X               |
| FAT32       |        | X     | X         |          | X               |
| NTFS        |        |       |           | X        | X               |

#### 15.2.5 Primary Disk Areas

FAT12 and FAT16 volumes have specific locations reserved for the boot record, file allocation table, and root directory. (The root directory on a FAT32 drive is not stored in a fixed location.) The size of each area is determined when the volume is formatted. For example, the mapping of sectors on a 3.5-inch, 1.44 MByte diskette is shown in Table 15-3.

Table 15-3 Sector Mapping of a 1.44 MByte Diskette.

| Logical Sector | Contents                    |
|----------------|-----------------------------|
| 0              | Boot record                 |
| 1–18           | File allocation table (FAT) |
| 19–32          | Root directory              |
| 33–2,879       | Data area                   |



**Boot Record** The *boot record* contains a table holding volume information and a short boot program that loads MS-DOS into memory. The boot program checks for the existence of certain operating system files and loads them into memory. Table 15-4 shows a representative list of fields in a typical MS-DOS boot record. The exact arrangement of fields varies among different versions of the operating system.

Table 15-4 MS-DOS Boot Record Layout.

| Offset | Length | Description                                      |
|--------|--------|--------------------------------------------------|
| 00     | 3      | Jump to boot code (JMP instruction)              |
| 03     | 8      | Manufacturer name, version number                |
| 0B     | 2      | Bytes per sector                                 |
| 0D     | 1      | Sectors per cluster (power of 2)                 |
| 0E     | 2      | Number of reserved sectors (preceding FAT #1)    |
| 10     | 1      | Number of copies of FAT                          |
| 11     | 2      | Maximum number of root directory entries         |
| 13     | 2      | Number of disk sectors for drives under 32 MByte |
| 15     | 1      | Media descriptor byte                            |
| 16     | 2      | Size of FAT, in sectors                          |
| 18     | 2      | Sectors per track                                |
| 1A     | 2      | Number of drive heads                            |
| 1C     | 4      | Number of hidden sectors                         |
| 20     | 4      | Number of disk sectors for drives over 32 MByte  |
| 24     | 1      | Drive number (modified by MS-DOS)                |
| 25     | 1      | Reserved                                         |
| 26     | 1      | Extended boot signature (always 29h)             |
| 27     | 4      | Volume ID number (binary)                        |
| 2B     | 11     | Volume label                                     |
| 36     | 8      | File-system type (ASCII)                         |
| 3E     | —      | Start of boot program and data                   |

**File Allocation Table (FAT)** The file allocation table is fairly complex, so we will discuss it at more length in Section 15.3.3.

**Root Directory** The *root directory* is a disk volume's main directory. Directory entries can be other directory names or references to files. A directory entry that refers to a file contains the filename, size, attribute, and starting cluster number used by the file.

**Data Area** The *data area* of the disk is where files and subdirectories are stored.

## 15.2.6 Section Review

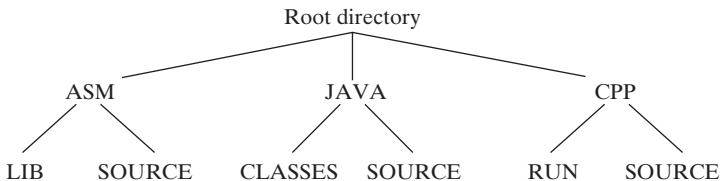
1. (*True/False*): A file system maps logical sectors to clusters.
2. (*True/False*): The starting cluster number of a file is stored in the *disk parameter table*.
3. (*True/False*): All file systems except NTFS require the use of at least one cluster to store a file.

4. (*True/False*): The FAT32 file system allows the setting of individual user permissions for directories, but not files.
5. (*True/False*): Linux does not support the FAT32 file system.
6. Under Windows 98, what is the largest permitted FAT16 volume?
7. Suppose your disk volume's boot record was corrupted. Which file system(s) would provide support for a backup copy of the boot record?
8. Which MS-Windows file system(s) support 16-bit Unicode filenames?
9. Which MS-Windows file system(s) support *disk mirroring*, where the same data is simultaneously written to multiple drives?
10. Suppose you need to keep a record of the last ten changes to a file. Which file system(s) supports this feature?
11. If you have a 20 GByte disk volume and you wish to have a cluster size  $\leq$  8 KByte (to avoid wasted space), which file system(s) could you use?
12. What is the largest FAT32 disk volume that supports 4 KByte clusters?
13. Describe the four areas (in order) of a 1.44 MByte diskette.
14. On a disk drive formatted by MS-DOS, how might you determine the number of sectors used by each cluster?
15. *Challenge*: If a disk has a cluster size of 8 KByte, how many bytes of wasted space will there be when storing an 8200-byte file?
16. *Challenge*: Explain how NTFS stores sparse files. (To answer this question, you will have to visit the Microsoft MSDN Web site and look for the information.)

## 15.3 Disk Directory

Every FAT-style and NTFS disk has a *root directory* containing the primary list of files on the disk. The root directory may also contain the names of other directories, called *subdirectories*. A subdirectory may be thought of as a directory whose name appears in some other directory—the latter is known as the *parent directory*. Each subdirectory can contain filenames and additional directory names. The result is a treelike structure with the root directory at the top, branching out to other directories at lower levels (Fig. 15-6).

FIGURE 15-6 Disk directory tree example.



Each directory name and each file within a directory is qualified by the names of the directories above it, called the *path*. For example, the path for the file PROG1.ASM in the SOURCE directory below ASM on drive C is

```
C:\ASM\SOURCE\PROG1.ASM
```

Generally, the drive letter can be omitted from the path when an input–output operation is carried out on the current disk drive. A complete list of the directory names in our sample directory tree follows:

```
C:\
  \ASM
  \ASM\LIB
  \ASM\SOURCE
  \JAVA
  \JAVA\CLASSES
  \JAVA\SOURCE
  \CPP
  \CPP\RUN
  \CPP\SOURCE
```

Thus, a *file specification* can take the form of an individual filename or a directory path followed by a filename. It can also be preceded by a drive specification.

### 15.3.1 MS-DOS Directory Structure

If we tried to explain all the various directory formats available today on Intel-based computers, we would at least have to include Linux, MS-DOS, and all the versions of MS-Windows. Instead, let's use MS-DOS as a basic example and examine its structure more closely. Then we will follow with a description of the extended filename structure available in MS-Windows.

Each MS-DOS directory entry is 32 bytes long and contains the fields shown in Table 15-5. The *filename* field holds the name of a file, a subdirectory, or the disk volume label. The first byte may indicate the file's status, or it may be the first character of a filename. The possible status values are shown in Table 15-6. The 16-bit *starting cluster number* field refers to the number of the first cluster allocated to the file, as well as its starting entry in the file allocation table (FAT). The *file size* field is a 32-bit number that indicates the file size, in bytes.

Table 15-5 MS-DOS Directory Entry.

| Hexadecimal Offset | Field Name              | Format        |
|--------------------|-------------------------|---------------|
| 00-07              | Filename                | ASCII         |
| 08-0A              | Extension               | ASCII         |
| 0B                 | Attribute               | 8-bit binary  |
| 0C-15              | Reserved by MS-DOS      |               |
| 16-17              | Time stamp              | 16-bit binary |
| 18-19              | Date stamp              | 16-bit binary |
| 1A-1B              | Starting cluster number | 16-bit binary |
| 1C-1F              | File size               | 32-bit binary |

Table 15-6 Filename Status Byte.

| Status Byte | Description                                                                                                                                                       |
|-------------|-------------------------------------------------------------------------------------------------------------------------------------------------------------------|
| 00h         | The entry has never been used.                                                                                                                                    |
| 01h         | If the attribute byte = 0Fh and the status byte = 01h, this is the first long filename entry. (Holds the last part of the name, ".", and the filename extension.) |
| 05h         | The first character of the filename is actually the E5h character (rare).                                                                                         |
| E5h         | The entry contains a filename, but the file has been erased.                                                                                                      |

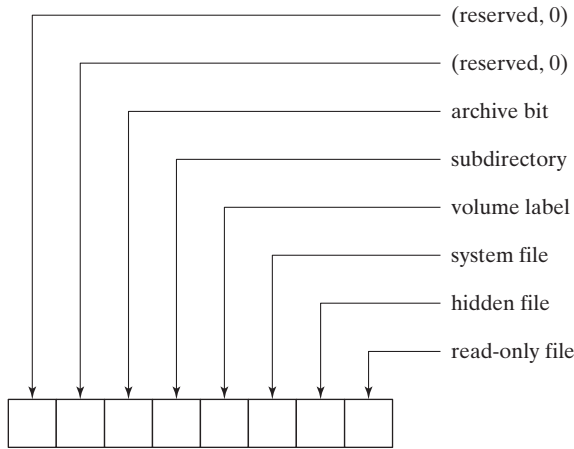
TABLE 15-6 (Continued)

| Status Byte | Description                                                                                                                                                                                                                                    |
|-------------|------------------------------------------------------------------------------------------------------------------------------------------------------------------------------------------------------------------------------------------------|
| 2Eh         | The entry (.) is for a directory name. If the second byte is also 2Eh (.), the cluster field contains the cluster number of this directory's parent directory.                                                                                 |
| 4nh         | First long filename entry (holds the first part of the name): If the attribute byte = 0Fh, this marks the last of multiple entries containing a single long filename. The digit <i>n</i> indicates the number of entries used by the filename. |

**Attribute Field**

The *attribute* field identifies the type of file. The field is bit-mapped and usually contains a combination of one of the values shown in Fig. 15-7. The two *reserved* bits should always be 0. The *archive* bit is set when a file is modified. The *subdirectory* bit is set if the entry contains the name of a subdirectory. The *volume label* identifies the entry as the name of a disk volume. The *system file* bit indicates that the file is part of the operating system. The *hidden file* bit makes the file hidden; its name does not appear in a display of the directory. The *read-only* bit prevents the file from being deleted or modified in any way. Finally, an attribute value of 0Fh indicates that the current directory entry is for an extended filename.

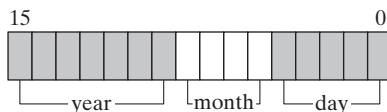
FIGURE 15-7 File attribute byte fields.



**Date and Time**

The *date stamp* field (Fig. 15-8) indicates the date when the file was created or last changed, expressed as a bit-mapped value. The year value is between 0 and 119, and is automatically added to 1980 (the year the IBM-PC was released). The month value is between 1 and 12, and the day value is between 1 and 31.

FIGURE 15-8 File date stamp field.



The *time stamp* field (Fig. 15-9) indicates the time when the file was created or last changed, expressed as a bit-mapped value. The hours may be 0 to 23, the minutes 0 to 59, and the seconds 0 to

59, stored as a count of 2-second increments. For example, a value of 10100 binary equals 40 seconds. The time stamp in Fig. 15-10 indicates a time of 14:02:40.

FIGURE 15-9 File time stamp field.

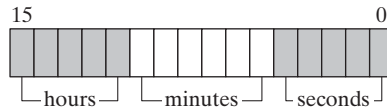
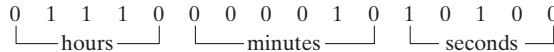
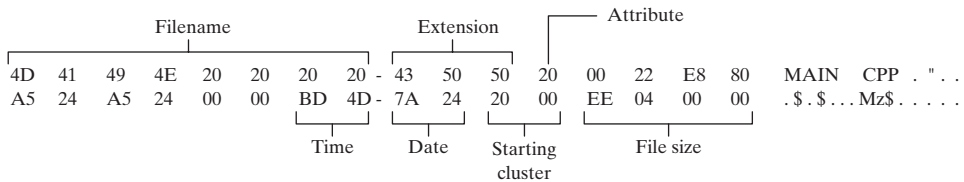


FIGURE 15-10 Time stamp example.



**File Directory Entry Example** Let's examine the entry for a file named MAIN.CPP (Fig. 15-11). This file has a normal attribute, and its archive bit (20h) has been set, showing that the file was modified. Its starting cluster number is 0020h, its size is 000004EEh bytes, the *Time* field equals 4DBDh (9:45:58), and the *Date* field equals 247Ah (March 26, 1998).

FIGURE 15-11 Sample file directory entry.



In this figure, the time, date, and starting cluster number are 16-bit values, stored in little-endian order (low byte, followed by high byte). The *File size* field is a doubleword, also stored in little-endian order.

### 15.3.2 Long Filenames in MS-Windows

In MS-Windows, a filename longer than 8 + 3 characters or a filename using a combination of uppercase and lowercase letters is assigned multiple disk directory entries. If the attribute byte equals 0Fh, the system looks at the byte at offset 0. If the upper digit equals 4, this entry begins a series of long filename entries. The lower digit indicates the number of directory entries to be used by the long filename. Subsequent entries count downward from  $n - 1$  to 1, where  $n$  = the number of entries. For example, if a filename requires three entries, the first status byte will be 43h. The subsequent entries will be status bytes equal to 02h and 01h, as may be seen in the following table:

| Status Byte | Description                                                                                                                                                   |
|-------------|---------------------------------------------------------------------------------------------------------------------------------------------------------------|
| 43          | Indicates that three entries are used for the long filename, total, and this entry holds the last part of the filename, ".", and a three-character extension. |
| 02          | Holds the second part of the filename.                                                                                                                        |
| 01          | Holds the first part of the filename.                                                                                                                         |

**Example** To illustrate, let's use a file having the 26-character filename ABCDEFGHIJKLM-NOPQRSTUVWXYZ.TXT and save it as a text file in the root directory of drive A. Next, we run DEBUG.EXE from the command prompt and load the directory sectors into memory at offset 100. This is followed by the D (dump command)<sup>1</sup>:

```
L 100 0 13 5          (load sectors 13h - 17h)
D 100                (dump offset 100 on the screen)
```

Windows creates three directory entries for this file, as shown in Fig. 15-12.

Let's start with the entry at 01C0h. The first byte, containing 01, marks this entry as the last of a sequence of long filename entries. It is followed by the first 13 characters of the filename "ABCDEF GHIJKLM." Each Unicode character is 16 bits, stored in little-endian order. Note that the attribute byte at offset 0B equals 0F, indicating that this is an extended filename entry (any filename having this attribute is automatically ignored by MS-DOS).

The entry at 01A0h contains the final 13 characters of the long filename, which are "NOPQRSTUV.TXT:"

At offset 01E0h, the autogenerated short filename is built from the first six letters of the long filename, followed by ~1, followed by the first three characters after the last period in the original name. These characters are 1-byte ASCII codes. The short filename entry also contains the file creation date and time, the last access date, the last modified date and time, the starting cluster number, and the file size. Figure 15-13 shows the information displayed by the Windows Explorer *Properties* dialog, which matches the raw directory data.

FIGURE 15-12 Directory entry for a long filename.

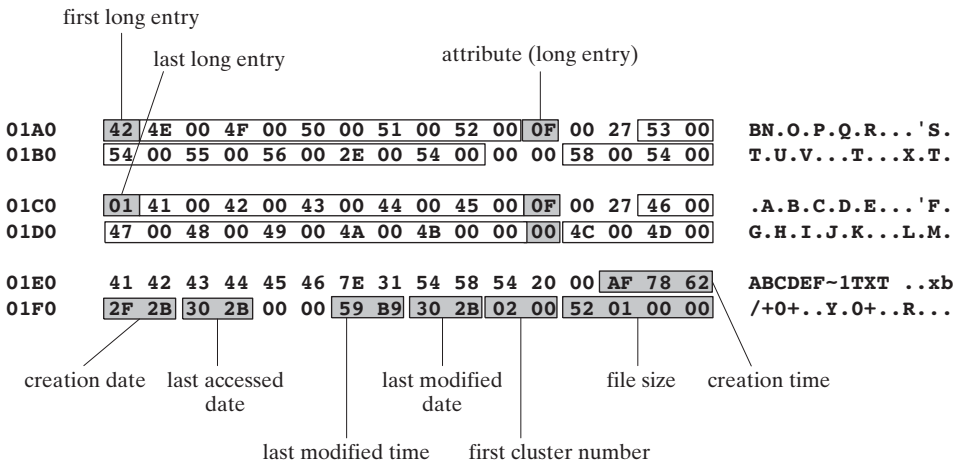
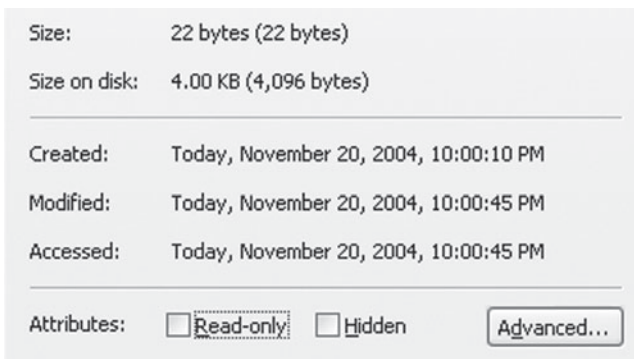


FIGURE 15-13 File properties dialog.



### 15.3.3 File Allocation Table (FAT)

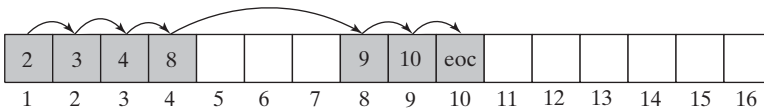
The FAT12, FAT16, and FAT32 file systems use a table called the *file allocation table* (FAT) to keep track of each file's location on the disk. The FAT maps the disk clusters, showing their ownership by specific files. Each entry corresponds to a cluster number, and each cluster contains one or more sectors. In other words, the 10th FAT entry identifies the 10th cluster on the disk, the 11th entry identifies the 11th cluster, and so on.

Each file is represented in the FAT as a linked list, called a *cluster chain*. Each FAT entry contains an integer that identifies the next entry. Two cluster chains are shown in Fig. 15-14, one for **File1** and the other for **File2**. **File1** occupies clusters 1, 2, 3, 4, 8, 9, and 10. **File2** occupies clusters 5, 6, 7, 11, and 12. The **eoc** (*end of chain*) marker in the last FAT entry for a file is a predefined integer value marking the final cluster in the chain.

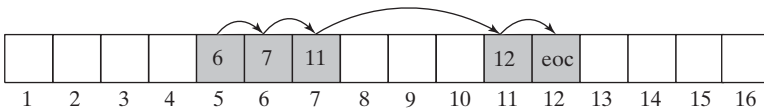
When a file is created, the operating system looks for the first available cluster entry in the FAT. Gaps occur when not enough contiguous clusters are available to hold the entire file. In the preceding diagram, this happened to both **File1** and **File2**. When a file is modified and saved back to disk, its cluster chain often becomes increasingly fragmented. If many files become fragmented, the disk's performance begins to degrade because the read/write heads must jump between different tracks to locate all of a file's clusters. Most operating systems supply a built-in disk defragmentation utility.

FIGURE 15-14 Example: Two cluster chains.

File1: starting cluster number = 1, size = 7 clusters



File2: starting cluster number = 5, size = 5 clusters



### 15.3.4 Section Review

1. (*True/False*): A file specification includes both a file path and a file name.
2. (*True/False*): The primary list of files on a disk is called the *base directory*.
3. (*True/False*): A file's directory entry contains the file's starting sector number.
4. (*True/False*): The MS-DOS date field in a directory entry must be added to 1980.
5. How many bytes are used by an MS-DOS directory entry?
6. Name the seven basic fields of an MS-DOS directory entry (do not include the *reserved* field).
7. In an MS-DOS filename entry, identify the six possible status byte values.
8. Show the format of the time stamp field in an MS-DOS directory entry.
9. When a long filename is stored in a volume directory (under MS-Windows), how is the first long filename entry identified?
10. If a filename has 18 characters, how many long filename entries are required?
11. MS-Windows added two new date fields to the original MS-DOS file directory entry. What are their names?
12. *Challenge*: Illustrate the file allocation table links for a file that uses clusters 2, 3, 7, 6, 4, and 8, in that order.

## 15.4 Reading and Writing Disk Sectors

INT 21h Function 7305h (absolute disk read and write) lets you read and write logical disk sectors. Like all INT instructions, it is designed to run only in 16-bit real-address mode. We will not attempt to call INT 21h (or any other interrupt) from protected mode because of the complexities involved.

Function 7305h works on FAT12, FAT16, and FAT32 file systems under Windows 95, 98, and Windows Me. It does not work under Windows NT, 2000, XP, or beyond because of their tighter security. Any program permitted to read and write disk sectors could easily bypass file and directory sharing permissions. When calling function 7305h, pass the following arguments:

|       |                                                       |
|-------|-------------------------------------------------------|
| AX    | 7305h                                                 |
| DS:BX | Segment/offset of a DISKIO structure variable         |
| CX    | 0FFFFh                                                |
| DL    | Drive number (0 = default, 1 = A, 2 = B, 3 = C, etc.) |
| SI    | Read/write flag                                       |

A DISKIO structure contains the starting sector number, the number of sectors to read or write, and the segment/offset address of the sector buffer:

```
DISKIO STRUCT
    startSector  DWORD 0           ; starting sector number
    numSectors   WORD 1           ; number of sectors
    bufferOfs    WORD OFFSET buffer ; buffer offset
    bufferSeg    WORD SEG buffer   ; buffer segment
DISKIO ENDS
```

Following are examples of an input buffer to hold the sector data, along with a DISKIO structure variable:

```
.data
buffer BYTE 512 DUP(?)
diskStruct DISKIO <>
diskStruct2 DiskIO <10,5> ; sectors 10,11,12,13,14
```

When calling Function 7305h, the argument passed in SI determines whether you want to read or write sectors. To read, clear bit 0; to write, set bit 0. In addition, bits 13, 14, and 15 are configured when writing sectors using the following scheme:

| Bits 15–13 | Type of Sector   |
|------------|------------------|
| 000        | Other/unknown    |
| 001        | FAT data         |
| 010        | Directory data   |
| 011        | Normal file data |

The remaining bits (1 through 12) must always be clear.

**Example 1:** The following statements read one or more sectors from drive C:

```
mov ax,7305h           ; absolute Read/Write
mov cx,0FFFFh         ; always this value
mov dl,3              ; drive C
mov bx,OFFSET diskStruct ; DISKIO structure
mov si,0              ; read sector
int 21h
```



**Example 2:** The following statements write one or more sectors to drive A:

```

mov  ax,7305h           ; absolute Read/Write
mov  cx,0FFFFh        ; always this value
mov  dl,1              ; drive A
mov  bx,OFFSEt diskStruct ; DISKIO structure
mov  si,6001h         ; write normal sector(s)
int  21h

```

### 15.4.1 Sector Display Program

Let's put what we've learned about sectors to good use by writing a program that reads and displays individual disk sectors in ASCII format. The pseudocode is listed here:

```

Ask for starting sector number and drive number
do while (keystroke <> ESC)
  Display heading
  Read one sector
  If MS-DOS error then exit
  Display one sector
  Wait for keystroke
  Increment sector number
end do

```

**Program Listing** Here is a complete listing of the 16-bit *Sector.asm* program. It runs in real-address mode under Windows 95, 98, and Me, but not under Windows NT, 2000, XP, and beyond because of their tighter security relating to disk access:

```

; Sector Display Program           (Sector.asm)
; Demonstrates INT 21h function 7305h (ABSDiskReadWrite)
; This Real-mode program reads and displays disk sectors.
; Works on FAT16 & FAT32 file systems running under Windows
; 95, 98, and Millenium.

INCLUDE Irvine16.inc

Setcursor PROTO, row:BYTE, col:BYTE
EOLN EQU <0dh,0ah>
ESC_KEY = 1Bh
DATA_ROW = 5
DATA_COL = 0
SECTOR_SIZE = 512
READ_MODE = 0 ; for Function 7505h

DiskIO STRUCT
    startSector DWORD ? ; starting sector number
    numSectors WORD 1 ; number of sectors
    bufferOfs WORD OFFSEt buffer ; buffer offset
    bufferSeg WORD @DATA ; buffer segment
DiskIO ENDS

.data
driveNumber BYTE ?
diskStruct DiskIO <>
buffer BYTE SECTOR_SIZE DUP(0),0 ; one sector

curr_row BYTE ?
curr_col BYTE ?

```

```

; String resources
strLine      BYTE  EOLN,79 DUP(0C4h),EOLN,0
strHeading   BYTE  "Sector Display Program (Sector.exe)"
             BYTE  EOLN,EOLN,0
strAskSector BYTE  "Enter starting sector number: ",0
strAskDrive  BYTE  "Enter drive number (1=A, 2=B, "
             BYTE  "3=C, 4=D, 5=E, 6=F): ",0
strCannotRead BYTE EOLN,"*** Cannot read the sector. "
             BYTE  "Press any key...", EOLN, 0
strReadingSector \
             BYTE  "Press Esc to quit, or any key to continue..."
             BYTE  EOLN,EOLN,"Reading sector: ",0

.code
main PROC
    mov     ax,@data
    mov     ds,ax
    call    Clrscr
    mov     dx,OFFSET strHeading           ; display greeting
    call    Writestring                    ; ask user for...
    call    AskForSectorNumber

L1:  call    Clrscr
    call    ReadSector                      ; read a sector
    jc     L2                               ; quit if error
    call    DisplaySector
    call    ReadChar
    cmp     al,ESC_KEY                      ; Esc pressed?
    je     L3                               ; yes: quit
    inc     diskStruct.startSector          ; next sector
    jmp    L1                               ; repeat the loop

L2:  mov     dx,OFFSET strCannotRead        ; error message
    call    Writestring
    call    ReadChar

L3:  call    Clrscr
    exit
main ENDP

;-----
AskForSectorNumber PROC
;
; Prompts the user for the starting sector number
; and drive number. Initializes the startSector
; field of the DiskIO structure, as well as the
; driveNumber variable.
;-----
    pusha
    mov     dx,OFFSET strAskSector
    call    WriteString
    call    ReadInt
    mov     diskStruct.startSector,eax
    call    Crlf
    mov     dx,OFFSET strAskDrive
    call    WriteString
    call    ReadInt

```

```

        mov     driveNumber,aI
        call   CrLf
        popa
        ret
AskForSectorNumber ENDP
;-----
ReadSector PROC
;
; Reads a sector into the input buffer.
; Receives: DL = Drive number
; Requires: DiskIO structure must be initialized.
; Returns:  If CF=0, the operation was successful;
;           otherwise, CF=1 and AX contains an
;           error code.
;-----
        pusha
        mov     ax,7305h           ; ABSDiskReadWrite
        mov     cx,-1             ; always -1
        mov     bx,OFFSET diskStruct ; sector number
        mov     si,READ_MODE      ; read mode
        int     21h               ; read disk sector
        popa
        ret
ReadSector ENDP
;-----
DisplaySector PROC
;
; Display the sector data in <buffer>, using INT 10h
; BIOS function calls. This avoids filtering of ASCII
; control codes.
; Receives: nothing. Returns: nothing.
; Requires: buffer must contain sector data.
;-----
        mov     dx,OFFSET strHeading ; display heading
        call   WriteString
        mov     eax,diskStruct.startSector ; display sector number
        call   WriteDec
        mov     dx,OFFSET strLine    ; horizontal line
        call   Writestring
        mov     si,OFFSET buffer     ; point to buffer
        mov     curr_row,DATA_ROW    ; set row, column
        mov     curr_col,DATA_COL
        INVOKE SetCursor,curr_row,curr_col

        mov     cx,SECTOR_SIZE      ; loop counter
        mov     bh,0                 ; video page 0
L1:  push    cx                       ; save loop counter
        mov     ah,0Ah               ; display character
        mov     al,[si]              ; get byte from buffer
        mov     cx,1                 ; display it
        int     10h
        call   MoveCursor
        inc     si                    ; point to next byte
        pop     cx                    ; restore loop counter
        loop   L1                    ; repeat the loop

```

```

        ret
DisplaySector ENDP
;-----
MoveCursor PROC
;
; Advance the cursor to the next column,
; check for possible wraparound on screen.
;-----
        cmp     curr_col,79           ; last column?
        jae    L1                    ; yes: go to next row
        inc    curr_col              ; no: increment column
        jmp    L2
L1:     mov     curr_col,0            ; next row
        inc    curr_row
L2:     INVOKE Setcursor,curr_row,curr_col
        ret
MoveCursor ENDP
;-----
Setcursor PROC USES dx,
        row:BYTE, col:BYTE
;
; Set the screen cursor position
;-----
        mov     dh, row
        mov     dl, col
        call   Gotoxy
        ret
Setcursor ENDP
END main

```

The core of the program is the **ReadSector** procedure, which reads each sector from the disk using INT 21h Function 7305h. The sector data is placed in a buffer, and the buffer is displayed by the **DisplaySector** procedure.

*Using INT 10h* Most sectors contain binary data, and if INT 21h were used to display them, ASCII control characters would be filtered. Tab and Newline characters, for example, would cause the display to become disjointed. Instead, it's better to use INT 10h Function 0Ah, which displays ASCII codes 0 to 31 as graphics characters. INT 10h is described in Chapter 16. Because Function 0Ah does not advance the cursor, additional code must be written to move the cursor one column to the right after displaying each character. The **SetCursor** procedure simplifies the implementation of the **Gotoxy** procedure in the Irvine16 library.

*Variations* Interesting variations can be created on the Sector Display program. For example, you can prompt the user for a range of sector numbers to be displayed. Each sector can be displayed in hexadecimal. You can let the user scroll forward and backward through the sectors using the PageUp and PageDown keys. Some of these enhancements appear in the chapter exercises.

## 15.4.2 Section Review

1. (*True/False*): You can read sectors from a hard drive using INT 21h Function 7305h under Windows Me, but not under Windows XP.
2. (*True/False*): INT 21h Function 7305h reads one or more disk sectors only in protected mode.
3. What input parameters are required by INT 21h Function 7305h?

4. In the Sector Display program (Section 15.4.1), why is Interrupt 10h used to display characters?
5. *Challenge:* In the Sector Display program (Section 15.4.1), what would happen if the starting sector number was out of range?

## 15.5 System-Level File Functions

In real-address mode, INT 21h provides system services (Table 15-7) that create and change directories, change file attributes, find matching files, and so forth. These services go beyond what is typically available in high-level programming language libraries. When calling any of these services, the function number is placed in AH or AX. Other registers may contain input parameters. Let's take a detailed look at a few commonly used functions. A more detailed list of MS-DOS interrupts and their descriptions can be found in Appendix D.

Windows 95/98/Me supports all existing MS-DOS INT 21h functions and provides extensions that permit MS-DOS-based applications to take advantage of features such as long file names and exclusive volume locking. INT 21h Function 7303h (get disk free space) is an example of an enhanced system function that recognizes disks larger than those originally supported in MS-DOS.

TABLE 15-7 Selected INT 21h Disk Services.

| Function Number | Function Name                  |
|-----------------|--------------------------------|
| 0Eh             | Set default drive              |
| 19h             | Get default drive              |
| 7303h           | Get disk free space            |
| 39h             | Create subdirectory            |
| 3Ah             | Remove subdirectory            |
| 3Bh             | Set current directory          |
| 41h             | Delete file                    |
| 43h             | Get/set file attribute         |
| 47h             | Get current directory path     |
| 4Eh             | Find first matching file       |
| 4Fh             | Find next matching file        |
| 56h             | Rename file                    |
| 57h             | Get/set file date and time     |
| 59h             | Get extended error information |

### 15.5.1 Get Disk Free Space (7303h)

INT 21h Function 7303h can be used to find both the size of a disk volume and how much free disk space is available on a FAT16 or FAT32 drive. The information is returned in a standard structure named **ExtGetDskFreSpcStruc**, as follows:

```
ExtGetDskFreSpcStruc STRUC
    StructSize      WORD ?
    Level           WORD ?
    SectorsPerCluster  DWORD ?
    BytesPerSector  DWORD ?
    AvailableClusters  DWORD ?
    TotalClusters   DWORD ?
    AvailablePhysSectors  DWORD ?
    TotalPhysSectors  DWORD ?
```

```

    AvailableAllocationUnits  DWORD ?
    TotalAllocationUnits     DWORD ?
    Rsvd                     DWORD 2 DUP (?)
ExtGetDskFreSpcStruc  ENDS

```

(A copy of this structure is in the *Irvine16.inc* file.) The following list contains a short description of each field:

- **StructSize**: A return value that represents the size of the **ExtGetDskFreSpcStruc** structure in bytes. When INT 21h Function 7303h (Get\_ExtFreeSpace) executes, it places the structure size in this member.
- **Level**: An input and return level value. This field must be initialized to zero.
- **SectorsPerCluster**: The number of sectors inside each cluster.
- **BytesPerSector**: The number of bytes in each sector.
- **AvailableClusters**: The number of available clusters.
- **TotalClusters**: The total number of clusters on the volume.
- **AvailablePhysSectors**: The number of physical sectors available on the volume, without adjustment for compression.
- **TotalPhysSectors**: The total number of physical sectors on the volume, without adjustment for compression.
- **AvailableAllocationUnits**: The number of available allocation units on the volume, without adjustment for compression.
- **TotalAllocationUnits**: The total number of allocation units on the volume, without adjustment for compression.
- **Rsvd**: Reserved member.

**Calling the Function** When calling INT 21h Function 7303h, the following input parameters are required:

- AX must equal 7303h.
- ES:DI must point to a **ExtGetDskFreSpcStruc** variable.
- CX must contain the size of the **ExtGetDskFreSpcStruc** variable.
- DS:DX must point to a null-terminated string containing the drive name. You can use the MS-DOS type of drive specification such as ("C:\"), or you can use a universal naming convention volume specification such as ("\\Server\Share").

If the function executes successfully, it clears the Carry flag and fills in the structure. Otherwise, it sets the Carry flag. After calling the function, the following types of calculations might be useful:

- To find out how large the volume is in kilobytes, use the formula  $(\text{TotalClusters} * \text{SectorsPerCluster} * \text{BytesPerSector}) / 1024$ .
- To find out how much free space exists in the volume, in kilobytes, the formula is  $(\text{AvailableClusters} * \text{SectorsPerCluster} * \text{BytesPerSector}) / 1024$ .

### Disk Free Space Program

The following program uses INT 21h Function 7303h to get free space information on a FAT-type drive volume. It displays both the volume size and free space. It runs under Windows 95, 98, and Millennium, but not under Windows NT, 2000, XP, and beyond:

```

; Disk Free Space                                     (DiskSpc.asm)
INCLUDE Irvine16.inc

.data
buffer ExtGetDskFreSpcStruc <>
driveName BYTE "C:\",0

```

```

str1 BYTE "Volume size (KB): ",0
str2 BYTE "Free space (KB): ",0
str3 BYTE "Function call failed.",0dh,0ah,0

.code
main PROC
    mov     ax,@data
    mov     ds,ax
    mov     es,ax

    mov     buffer.Level,0           ; must be zero
    mov     di,OFFSET buffer        ; ES:DI points to buffer
    mov     cx,SIZEOF buffer        ; buffer size
    mov     dx,OFFSET DriveName     ; ptr to drive name
    mov     ax,7303h                ; get disk free space
    int     21h
    jc     error                    ; failed if CF = 1

    mov     dx,OFFSET str1          ; volume size
    call    WriteString
    call    CalcVolumeSize
    call    WriteDec
    call    Crlf

    mov     dx,OFFSET str2          ; free space
    call    WriteString
    call    CalcVolumeFree
    call    WriteDec
    call    Crlf
    jmp     quit

error:
    mov     dx,OFFSET str3
    call    WriteString

quit:
    exit
main ENDP

;-----
CalcVolumeSize PROC
;
; Calculate and return the disk volume size, in kilobytes.
; Receives: buffer variable, a ExtGetDskFreSpcStruc structure
; Returns:  EAX = volume size
; Remarks:  (SectorsPerCluster * 512 * TotalClusters) / 1024
;-----
    mov     eax,buffer.SectorsPerCluster
    shl     eax,9                   ; mult by 512
    mul     buffer.TotalClusters
    mov     ebx,1024
    div    ebx                       ; return kilobytes
    ret
CalcVolumeSize ENDP

;-----
CalcVolumeFree PROC
;
; Calculate and return the number of available kilobytes
; on the given volume.
; Receives: buffer variable, a ExtGetDskFreSpcStruc structure

```

```

; Returns:  EAX = available space, in kilobytes
; Remarks:  (SectorsPerCluster * 512 * AvailableClusters) / 1024
;-----
    mov     eax,buffer.SectorsPerCluster
    shl     eax,9                ; mult by 512
    mul     buffer.AvailableClusters
    mov     ebx,1024
    div     ebx                ; return kilobytes
    ret
CalcVolumeFree ENDP
END main

```

### 15.5.2 Create Subdirectory (39h)

INT 21h Function 39h creates a new subdirectory. It receives a pointer in DS:DX to a null-terminated string containing a path specification. The following example shows how to create a new subdirectory called ASM off the root directory of the default drive:

```

.data
pathname BYTE "\ASM",0
.code
    mov     ah,39h                ; create subdirectory
    mov     dx,OFFSET pathname
    int     21h
    jc     display_error

```

The Carry flag is set if the function fails. The possible error return codes are 3 and 5. Error 3 (*path not found*) means that some part of the pathname does not exist. Suppose we have asked the OS to create the directory ASM\PROG\NEW, but the path ASM\PROG does not exist. This would generate Error 3. Error 5 (*access denied*) indicates that the proposed subdirectory already exists or the first directory in the path is the root directory and it is already full.

### 15.5.3 Remove Subdirectory (3Ah)

INT 21h Function 3Ah removes a directory. It receives a pointer to the desired drive and path in DS:DX. If the drive name is left out, the default drive is assumed. The following code removes the \ASM directory from drive C:

```

.data
pathname BYTE 'C:\ASM',0
.code
    mov     ah,3Ah                ; remove subdirectory
    mov     dx,OFFSET pathname
    int     21h
    jc     display_error

```

The Carry flag is set if the function fails. The possible error codes are 3 (*path not found*), 5 (*access denied: the directory contains files*), 6 (*invalid handle*), and 16 (*attempt to remove the current directory*).

### 15.5.4 Set Current Directory (3Bh)

INT 21h Function 3Bh sets the current directory. It receives a pointer in DS:DX to a null-terminated string containing the target drive and path. For example, the following statements set the current directory to C:\ASM\PROGS:

```

.data
pathname BYTE "C:\ASM\PROGS",0
.code

```



```

mov  ah,3Bh                ; set current directory
mov  dx,OFFSET pathname
int  21h
jc   display_error

```

### 15.5.5 Get Current Directory (47h)

INT 21h Function 47h returns a string containing the current directory. It receives a drive number in DL (0 = default, 1 = A, 2 = B, etc.) and a pointer in DS:SI to a 64-byte buffer. In this buffer, MS-DOS places a null-terminated string with the full pathname from the root directory to the current directory (the drive letter and leading backslash are omitted). If the Carry flag is set when the function returns, the only possible error return code in AX is 0Fh (*invalid drive specification*).

In the following example, MS-DOS returns the current directory path on the default drive. Assuming that the current directory is C:\ASM\PROGS, the string returned by MS-DOS is “ASM\PROGS”:

```

.data
pathname BYTE 64 dup(0)      ; path stored here by MS-DOS
.code
mov  ah,47h                ; get current directory path
mov  dl,0                  ; on default drive
mov  si,OFFSET pathname
int  21h
jc   display_error

```

### 15.5.6 Get and Set File Attributes (7143h)

INT 21h Function 7143h retrieves or sets file attributes, among other tasks. (In Windows 9x, it replaces the older MS-DOS INT 21h Function 39.) Pass the offset of a filename in DX. To set the file attributes, assign 1 to BL and set CX to one or more attributes listed in Table 15-8. The `_A_NORMAL` attribute must be used alone, but the other attributes can be combined using the + operator.

TABLE 15-8 File Attributes (Defined in *Irvine16.inc*).

| Value                          | Meaning                                                                                       |
|--------------------------------|-----------------------------------------------------------------------------------------------|
| <code>_A_NORMAL</code> (0000h) | The file can be read from or written to. This value is valid only if used alone.              |
| <code>_A_RDONLY</code> (0001h) | The file can be read from, but not written to.                                                |
| <code>_A_HIDDEN</code> (0002h) | The file is hidden and does not appear in an ordinary directory listing.                      |
| <code>_A_SYSTEM</code> (0004h) | The file is part of the operating system or is used exclusively by it.                        |
| <code>_A_ARCH</code> (0020h)   | The file is an archive file. Applications use this value to mark files for backup or removal. |

The following code sets the attributes of a file to read-only and hidden:

```

mov  ax,7143h
mov  bl,1
mov  cx,_A_HIDDEN + _A_RDONLY
mov  dx,OFFSET filename
int  21h

```

To get the current attributes of a file, set BX to 0 and call the same function. The attribute values are returned in CX as a combination of powers of 2. Use the TEST instruction to evaluate individual attributes. For example,

```
test cx, _A_RDONLY
jnz readOnlyFile           ; file is read-only
```

The `_A_ARCH` attribute can appear with any of the other attributes.

### 15.5.7 Section Review

1. Which INT 21h function would you use to get the cluster size of a disk drive?
2. Which INT 21h function would you use to find out how many clusters are free on drive C?
3. Which INT 21h functions would you call if you wanted to create a directory named `D:\apps` and make it the current directory?
4. Which INT 21h function would you call if you wanted to make a file read-only?

## 15.6 Chapter Summary

At the operating system level, it is not useful to know the exact disk geometry (physical locations) or brand-specific disk information. The BIOS, which in this case amounts to disk controller firmware, acts as a broker between the disk hardware and the operating system.

The surface of a disk is formatted into concentric bands called *tracks*, on which data are stored magnetically. The *average seek time* measures the average amount of time spent moving from one track to another. Disk performance can be measured in RPM (revolutions per minute), as well as the *data transfer rate* (amount of data transferred to/from the drive in 1 second).

A *cylinder* refers to all tracks accessible from a single position of the read/write heads. Over time, as files become more spread out around a disk, they become fragmented and are no longer stored on adjacent cylinders.

A *sector* is a 512-byte portion of a track. Physical sectors are magnetically (invisibly) marked on the disk by the manufacturer, using what is called a low-level format.

*Physical disk geometry* describes a disk's structure to make it readable by the system BIOS. A single physical hard drive is divided into one or more logical units named partitions, or volumes. A drive may have multiple partitions. An extended partition can be subdivided into an unlimited number of logical partitions. Each logical partition appears as a separate drive letter and may have a different file system than other partitions. The primary partitions can each hold a bootable operating system.

The *master boot record* (MBR), created when the first partition is created on a hard disk, is located in the drive's first logical sector. The MBR contains the following:

- The *disk partition table* that describes the sizes and locations of all partitions on the disk.
- A small program that locates the partition's boot sector and transfers control to a program in the boot sector, which in turn loads the operating system.

A file system keeps track of the location, size, and attributes of each disk file. It provides a mapping of logical sectors to clusters, the basic unit of storage for all files and directories, and a mapping of file and directory names to sequences of clusters.

A *cluster* is the smallest unit of space used by a file; it consists of one or more adjacent disk sectors. A chain of clusters is referenced by a file allocation table (FAT) that keeps track of all clusters used by a file.

The following file systems are used in IA-32 Systems:

- The FAT12 file system was first used on IBM-PC diskettes.
- The FAT16 file system is the only available format for hard drives formatted under MS-DOS.
- The FAT32 file system was introduced with Windows 95 and was refined under Windows 98.
- The NTFS file system is supported by Windows NT, 2000, XP, and beyond.

Every disk in FAT-type and NTFS file systems has a *root directory*, which is the primary list of files on the disk. The root directory may also contain the names of other directories, called subdirectories.

MS-DOS and Windows use a table called the *file allocation table* (FAT) to keep track of each file's location on the disk. The FAT maps specific disk clusters to files. Each entry corresponds to a cluster number, and each cluster is associated with one or more sectors.

In real-address mode, INT 21h provides functions (Table 15-7) that create and change directories, change file attributes, find matching files, and so forth. These functions tend to be less available in high-level languages.

The Sector Display program reads and displays each sector from the diskette in drive A.

The Disk Free Space program displays both the size of the selected disk volume and the amount of free space.

## 15.7 Programming Exercises

The following exercises must be compiled and run in real-address mode. Be sure to make a backup copy of any disk affected by these programs, or create a temporary scratch disk to be used while testing them. *Under no circumstances should you run the programs on a fixed disk until you have debugged them carefully!*

### 1. Set Default Disk Drive

Write a procedure that prompts the user for a disk drive letter (A, B, C, or D), and then sets the default drive to the user's choice.

### 2. Disk Space

Write a procedure named **Get\_DiskSize** that returns the amount of total data space on a selected disk drive. *Input*: AL = drive number (0 = A, 1 = B, 2 = C, ...). *Output*: DX:AX = data space, in bytes.

### 3. Disk Free Space

Write a procedure named **Get\_DiskFreespace** that returns the amount of free space on a selected disk drive. *Input*: DS:DX points to a string containing the drive specifier. *Output*: EDX:EAX = disk free space, in bytes. Write a program that tests the procedure and displays the 64-bit result in hexadecimal.

### 4. Show File Attributes

Write a procedure named **ShowFileAttributes** that receives the offset of a filename in DX and displays the file's attributes in the console window. Attributes to look for are normal, hidden, read-only, and system. *Hint*: Use INT 21h Function 7143h.

Write a program that calls ShowFileAttributes, passing it the name of a file. Before running your program, set the file attributes from Windows Explorer by right-clicking on the filename, selecting Properties, and checking the Hidden and Read-Only options. Alternatively, you can run the `Attrib` command from the Windows command prompt. Run your program and verify that the attribute display is correct. Sample output:

```
temp.txt attributes: Hidden Read-only
```

### 5. Disk Free Space, in Clusters

Modify the Disk Free Space program from Section 15.5.1 so that it displays the following information:

```
Drive specification:      "C:\\"
Bytes per sector:       512
```

---

|                               |        |
|-------------------------------|--------|
| Sectors per cluster:          | 8      |
| Total Number of clusters:     | 999999 |
| Number of available clusters: | 99999  |

## 6. Displaying the Sector Number

Using the Sector Display program (Section 15.4.1) as a starting point, display a string at the top of the screen that indicates the drive specifier and current sector number (in hexadecimal).

## 7. Hexadecimal Sector Display

Using the Sector Display program (Section 15.4.1) as a starting point, add code that lets the user press F2 to display the current sector in hexadecimal, with 24 bytes on each line. The offset of the first byte in each line should be displayed at the beginning of the line. The display will be 22 lines high with a partial line at the end. The following is a sample of the first two lines, to show the layout:

```
0000 17311625 25425B75 279A4909 200D0655 D7303825 4B6F9234
0018 273A4655 25324B55 273A4959 293D4655 A732298C FF2323DB
(etc.)
```

## End Note

1. See the DEBUG tutorial on the book's Web site.

# BIOS-LEVEL PROGRAMMING

- 16.1 Introduction
  - 16.1.1 BIOS Data Area
- 16.2 Keyboard Input with INT 16h
  - 16.2.1 How the Keyboard Works
  - 16.2.2 INT 16h Functions
  - 16.2.3 Section Review
- 16.3 Video Programming with INT 10h
  - 16.3.1 Basic Background
  - 16.3.2 Controlling the Color
  - 16.3.3 INT 10h Video Functions
  - 16.3.4 Library Procedure Examples
  - 16.3.5 Section Review
- 16.4 Drawing Graphics Using INT 10h
  - 16.4.1 INT 10h Pixel-Related Functions
  - 16.4.2 DrawLine Program
  - 16.4.3 Cartesian Coordinates Program
  - 16.4.4 Converting Cartesian Coordinates to Screen Coordinates
  - 16.4.5 Section Review
- 16.5 Memory-Mapped Graphics
  - 16.5.1 Mode 13h: 320 × 200, 256 Colors
  - 16.5.2 Memory-Mapped Graphics Program
  - 16.5.3 Section Review
- 16.6 Mouse Programming
  - 16.6.1 Mouse INT 33h Functions
  - 16.6.2 Mouse Tracking Program
  - 16.6.3 Section Review
- 16.7 Chapter Summary
- 16.8 Programming Exercises

We recommend that you install an early version of Windows such as Windows 95 or Windows 98 to insure full compatibility with the programs in this chapter. You may want to use a software utility to create a virtual machine on your computer, so you can experiment with this software.

## 16.1 Introduction

Reading this chapter is like taking a step back in history. When the first IBM-PC appeared, droves of programmers (including myself) wanted to know how to get inside the box and work directly with the computer hardware. Peter Norton was quick to discover all sorts of useful and secret information, leading to his landmark book entitled *Inside the IBM-PC*. In a fit of generosity, IBM published all the assembly language source code for the IBM PC/XT BIOS (I still have a copy). Pioneering game designers such as Michael Abrash (author of *Quake* and *Doom*) learned how to optimize graphics and sound software, using their knowledge of PC hardware.<sup>1</sup> Now you can join this esteemed group and

work behind the scenes, below MS-DOS and Windows, at the BIOS (*basic input–output system*) level. Is the information obsolete? Absolutely not, if you are working on embedded systems applications or if you would like to learn how a computer BIOS is designed.

All of the programs in this chapter are 16-bit, real-mode applications. You can develop and run the programs shown here in any version of Microsoft Windows up to Windows XP. You will learn such useful things as:

- What happens when a keyboard key is pressed, and where all the characters end up.
- How to check the keyboard buffer to see if characters are waiting, and how to clear old keystrokes out of the buffer.
- How to read non-ASCII keyboard keys such as function keys and cursor arrows.
- How to display color text, and why colors are based on the video display's RGB color mixing system.
- How to divide up the screen into color panels and scroll each one separately.
- How to draw bit-mapped graphics in 256 colors.
- How to detect mouse movements and mouse clicks.

### 16.1.1 BIOS Data Area

The BIOS data area, partially shown in Table 16-1, contains system data used by the ROM BIOS service routines. For example, the keyboard typeahead buffer (at offset 001Eh) contains the ASCII codes and keyboard scan codes of keys waiting to be processed by the BIOS.

TABLE 16-1 BIOS Data Area, at Segment 0040h.

| Hex Offset  | Description                           |
|-------------|---------------------------------------|
| 0000 – 0007 | Port addresses, COM1 – COM4           |
| 0008 – 000F | Port addresses, LPT1 – LPT4           |
| 0010 – 0011 | Installed hardware list               |
| 0012        | Initialization flag                   |
| 0013 – 0014 | Memory size, in kilobytes             |
| 0015 – 0016 | Memory in I/O channel                 |
| 0017 – 0018 | Keyboard status flags                 |
| 0019        | Alternate key entry storage           |
| 001A – 001B | Keyboard buffer pointer (head)        |
| 001C – 001D | Keyboard buffer pointer (tail)        |
| 001E – 003D | Keyboard typeahead buffer             |
| 003E – 0048 | Diskette data area                    |
| 0049        | Current video mode                    |
| 004A – 004B | Number of screen columns              |
| 004C – 004D | Regen (video) buffer length, in bytes |
| 004E – 004F | Regen (video) buffer starting offset  |
| 0050 – 005F | Cursor positions, video pages 1 – 8   |
| 0060        | Cursor end line                       |

TABLE 16-1 (Continued)

| Hex Offset  | Description                           |
|-------------|---------------------------------------|
| 0061        | Cursor start line                     |
| 0062        | Currently displayed video page number |
| 0063 – 0064 | Active display base address           |
| 0065        | CRT mode register                     |
| 0066        | Register for color graphics adapter   |
| 0067 – 006B | Cassette data area                    |
| 006C – 0070 | Timer data area                       |

## 16.2 Keyboard Input with INT 16h

In Section 2.5 we differentiated the various levels of input–output available to assembly language programs. In this chapter, you are given the opportunity to work directly at the BIOS level by calling functions that were (for the most part) installed by the computer manufacturer. At this level, you are only one level above the hardware, so you have a lot of flexibility and control.

The BIOS handles keyboard input using calls to Interrupt 16h. BIOS routines do not permit redirection, but they make it easy to read extended keyboard keys such as function keys, arrow keys, PgUp, and PgDn. Each extended key generates an 8-bit *scan code*, shown on the inside cover of this book. The scan codes are unique to IBM-compatible computers. All keyboard keys generate scan codes, but we don't usually pay attention to scan codes for ASCII characters because ASCII codes are standardized on nearly all computers. Under MS-Windows, when an extended key is pressed, its ASCII code is either 00h or E0h, shown in the following table:

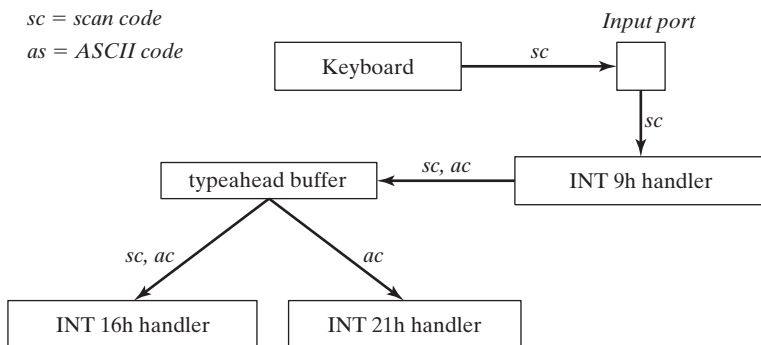
| Keys                                                                                 | ASCII Code |
|--------------------------------------------------------------------------------------|------------|
| Ins, Del, PageUp, PageDown, Home, End, Up arrow, Down arrow, Left arrow, Right arrow | E0h        |
| Function keys (F1 – F12)                                                             | 00h        |

### 16.2.1 How the Keyboard Works

Keyboard input follows an event path beginning with the keyboard controller chip and ending with characters being placed in an array called the *keyboard typeahead buffer* (see Fig. 16-1). Up to 15 keystrokes can be held in the buffer because a keystroke generates 2 bytes (ASCII code + scan code). The following events occur when the user presses a key:

- The keyboard controller chip sends an 8-bit numeric scan code (*sc*) to the PC's keyboard input port.
- The input port is designed so that it triggers an *interrupt*, a predefined signal to the CPU that an input–output device needs attention. The CPU responds by executing the INT 9h service routine.
- The INT 9h service routine retrieves the keyboard scan code (*sc*) from the input port and looks up the corresponding ASCII code (*ac*), if any. It inserts both the scan code and the ASCII code into the keyboard typeahead buffer. (If the scan code has no matching ASCII code, the key's ASCII code in the typeahead buffer equals zero or E0h.)

FIGURE 16-1 Keystroke Processing Sequence.



Once the scan code and ASCII code are safely in the typeahead buffer, they stay there until the currently running program retrieves them. There are two ways to do this in real-mode applications:

- Call a BIOS-level function using INT 16h that retrieves both the scan code and ASCII code from the keyboard typeahead buffer. This is useful when processing extended keys such as function keys and cursor arrows, which have no ASCII codes.
- Call an MS-DOS-level function using INT 21h that retrieves the ASCII code from the input buffer. If an extended key has been pressed, INT 21h must be called a second time to retrieve the scan code. INT 21h keyboard input was explained in Section 14.2.3.

### 16.2.2 INT 16h Functions

INT 16h has some clear advantages over INT 21h when it comes to keyboard handling. First, INT 16h can retrieve both the scan code and ASCII code in a single step. Second, INT 16h has additional operations such as setting the typematic rate and retrieving the state of the keyboard flags. The *typematic rate* is the rate at which a keyboard key repeats when you hold it down. When you don't know whether the user will press an ordinary key or an extended key, INT 16h is usually the best function to call.

#### Set Typematic Rate (03h)

INT 16h Function 03h lets you set the keyboard typematic repeat rate, as illustrated in the following table. When you hold down a key, there is a delay of 250 to 1000 milliseconds before the key starts to repeat. The repeat rate can be between 1Fh (slowest) and 0 (fastest).

| INT 16h Function 03h |                                                                                                                                                           |
|----------------------|-----------------------------------------------------------------------------------------------------------------------------------------------------------|
| <b>Description</b>   | Set typematic repeat rate                                                                                                                                 |
| <b>Receives</b>      | AH = 3<br>AL = 5<br>BH = repeat delay ( 0 = 250 ms; 1 = 500 ms; 2 = 750 ms; 3 = 1000 ms)<br>BL = repeat rate: 0 = fastest (30/sec), 1Fh = slowest (2/sec) |
| <b>Returns</b>       | Nothing                                                                                                                                                   |
| <b>Sample Call</b>   | <pre> mov ax,0305h mov bh,1      ; 500 ms repeat delay mov bl,0Fh   ; repeat rate int 16h                     </pre>                                      |



### Push Key into Keyboard Buffer (05h)

As shown in the next table, INT 16h Function 05h lets you push a key into the keyboard typeahead buffer. A key consists of two 8-bit integers: the ASCII code and the keyboard scan code.

| INT 16h Function 05h |                                                                                                       |
|----------------------|-------------------------------------------------------------------------------------------------------|
| <b>Description</b>   | Push key into keyboard buffer                                                                         |
| <b>Receives</b>      | AH = 5<br>CH = scan code<br>CL = ASCII code                                                           |
| <b>Returns</b>       | If typeahead buffer is full, CF = 1 and AL = 1; otherwise, CF = 0, AL = 0.                            |
| <b>Sample Call</b>   | <pre> mov  ah,5 mov  ch,3Bh      ; scan code for F1 key mov  cl,0        ; ASCII code int  16h </pre> |

### Wait for Key (10h)

INT 16h Function 10h removes the next available key from the keyboard typeahead buffer. If none is waiting, the keyboard handler waits for the user to press a key, as shown in the following table:

| INT 16h Function 10h |                                                                                                  |
|----------------------|--------------------------------------------------------------------------------------------------|
| <b>Description</b>   | Wait for key and scan key from keyboard                                                          |
| <b>Receives</b>      | AH = 10h                                                                                         |
| <b>Returns</b>       | AH = keyboard scan code<br>AL = ASCII code                                                       |
| <b>Sample Call</b>   | <pre> mov  ah,10h int  16h mov  scanCode,ah mov  ASCIIcode,a1 </pre>                             |
| <b>Notes</b>         | If no key is already in the buffer, the function waits for a key. Replaces INT 16h Function 00h. |

### Sample Program

The following keyboard display program uses a loop with INT 16h to input keystrokes and display both the ASCII code and scan code of each key. It terminates when the Esc key is pressed:

```

TITLE Keyboard Display          (Keybd.asm)

; This program displays keyboard scan codes
; and ASCII codes, using INT 16h.

INCLUDE Irvine16.inc
.code
main PROC
    mov  ax,@data
    mov  ds,ax
    call ClrScr                  ; clear screen

L1:  mov  ah,10h                 ; keyboard input
     int  16h                   ; using BIOS
     call DumpRegs              ; AH = scan, AL = ASCII

```

```

    cmp     al,1Bh           ; ESC key pressed?
    jne     L1              ; no: repeat the loop
    call   C1rScr          ; clear screen
    exit
main ENDP
END main

```

The call to **DumpRegs** displays all the registers, but you need only look at AH (scan code) and AL (ASCII code). When the user presses the F1 function key, for example, this is the resulting display (3B00h):

|              |              |              |                          |
|--------------|--------------|--------------|--------------------------|
| EAX=00003B00 | EBX=00000000 | ECX=000000FF | EDX=000005D6             |
| ESI=00000000 | EDI=00002000 | EBP=0000091E | ESP=00002000             |
| EIP=0000000F | EFL=00003202 | CF=0         | SF=0 ZF=0 OF=0 AF=0 PF=0 |

### Check Keyboard Buffer (11h)

INT 16h Function 11h lets you peek into the keyboard typeahead buffer to see if any keys are waiting. It returns the ASCII code and scan code of the next available key, if any. You can use this function inside a loop that carries out other program tasks. Note that the function does not remove the key from the typeahead buffer. See the following table for details:

| INT 16h Function 11h |                                                                                                                |
|----------------------|----------------------------------------------------------------------------------------------------------------|
| <b>Description</b>   | Check keyboard buffer                                                                                          |
| <b>Receives</b>      | AH = 11h                                                                                                       |
| <b>Returns</b>       | If a key is waiting, ZF = 0, AH = scan code, AL = ASCII code; otherwise, ZF = 1.                               |
| <b>Sample Call</b>   | <pre> mov  ah,11h int  16h jz   NoKeyWaiting      ; no key in buffer mov  scanCode,ah mov  ASCIIcode,al </pre> |
| <b>Notes</b>         | Does not remove the key (if any) from the buffer                                                               |

### Get Keyboard Flags

INT 16h Function 12h returns valuable information about the current state of the keyboard flags. Perhaps, you have noticed that word-processing programs often display flags or notations at the bottom of the screen when keys such as *CapsLock*, *NumLock*, and *Insert* are pressed. They do this by continually examining the keyboard status flag, watching for any changes.

| INT 16h Function 12h |                                                                                   |
|----------------------|-----------------------------------------------------------------------------------|
| <b>Description</b>   | Get keyboard flags                                                                |
| <b>Receives</b>      | AH = 12h                                                                          |
| <b>Returns</b>       | AX = copy of the keyboard flags                                                   |
| <b>Sample Call</b>   | <pre> mov  ah,12h int  16h mov  keyFlags,ax </pre>                                |
| <b>Notes</b>         | The keyboard flags are located at addresses 00417h – 00418h in the BIOS data area |

The keyboard flags are particularly interesting because they tell you a great deal about what the user is doing with the keyboard. Is the user holding down the left shift key or the right shift key? Is he or she also holding down the Alt key? Questions of this type can be answered using INT 16h. Each bit is a 1 when its matching key is either currently held down or is toggled on (Caps lock, Scroll lock, Num lock, and Insert). Under Windows 95 and 98, the keyboard flag bytes can also be obtained by directly reading memory at segment 0040h, offsets 17h 18h.

### Clearing the Keyboard Buffer

Programs often have a processing loop that can only be interrupted by prearranged keys. DOS-based game programs, for example, often check the keyboard buffer to see if arrow keys and other special keys have been pressed while at the same time displaying graphic images. The user might press any number of irrelevant keys that only fill up the keyboard typeahead buffer, but when the right key is pressed, the program is expected to immediately respond to the command.

Using the INT 16h functions, we know how to check the keyboard buffer to see if keys are waiting (Function 11h), and we know how to remove a key from the buffer (Function 10h). The following program demonstrates a procedure named **ClearKeyboard** that uses a loop to clear the keyboard buffer while checking for a particular keyboard scan code. For testing purposes, the program checks for the ESC key, but the procedure can check for any key:

```
TITLE Testing ClearKeyboard      (ClearKbd.asm)
; This program shows how to clear the keyboard
; buffer while waiting for a particular key.
; To test it, rapidly press random keys to fill
; up the buffer. When you press Esc, the program
; ends immediately.

INCLUDE Irvine16.inc
ClearKeyboard PROTO, scanCode:BYTE
ESC_key = 1                                ; scan code

.code
main PROC
L1:
    ; Display a dot, to show program's progress
    mov  ah,2
    mov  dl, '.'
    int  21h
    mov  eax,300                            ; delay for 300 ms
    call Delay

    INVOKE ClearKeyboard, ESC_key          ; check for Esc key
    jnz  L1                               ; continue loop if ZF=0

quit:
    call  Clrscr
    exit
main ENDP

;-----
ClearKeyboard PROC,
    scanCode:BYTE
;
; Clears the keyboard while checking for a
; particular scan code.
; Receives: keyboard scan code
; Returns: Zero flag set if the ASCII code is
; found; otherwise, Zero flag is clear.
;-----
```

```

        push  ax
L1:    mov   ah,11h           ; check keyboard buffer
        int  16h           ; any key pressed?
        jz   noKey         ; no: exit now
        mov  ah,10h        ; yes: remove from buffer
        int  16h
        cmp  ah,scanCode   ; was it the exit key?
        je   quit          ; yes: exit now (ZF=1)
        jmp  L1            ; no: check buffer again

noKey: ; no key pressed
        or   al,1          ; clear zero flag
quit:  pop   ax
        ret
ClearKeyboard ENDP
END main

```

The program displays a dot on the screen every 300 milliseconds. When testing it, press any sequence of random keys, which are ignored and removed from the typeahead buffer. The program stops as soon as ESC is pressed.

### 16.2.3 Section Review

1. Which interrupt (16h or 21h) is best for reading user input that includes function keys and other extended keys?
2. Where in memory are keyboard input characters kept while waiting to be processed by application programs?
3. What operations are performed by the INT 9h service routine?
4. Which INT 16h function pushes keys into the keyboard buffer?
5. Which INT 16h function removes the next available key from the keyboard buffer?
6. Which INT 16h function examines the keyboard buffer and returns the scan code and ASCII code of the first available input?
7. Does INT 16h function 11h remove a character from the keyboard buffer?
8. Which INT 16h function gives you the value of the keyboard flag byte?
9. Which bit in the keyboard flag byte indicates that the ScrollLock key has been pressed?
10. Write statements that input the keyboard flag byte and repeat a loop until the Ctrl key is pressed.
11. *Challenge:* The **ClearKeyboard** procedure in Section 16.2.2 checks for only a single keyboard scan code. Suppose your program had to check for multiple scan codes (the four cursor arrows, for example). Show examples of code modifications you could make to the procedure to make this possible.

## 16.3 Video Programming with INT 10h

### 16.3.1 Basic Background

#### *Three Levels of Access*

When an application program needs to write characters on the screen in text mode, it can choose among three types of output:

- **MS-DOS-level access:** Any computer running or emulating MS-DOS can use INT 21h to write text to the video display. Input/output can easily be redirected to other devices such as a printer or disk. Output is quite slow, and you cannot control the text color.
- **BIOS-level access:** Characters are output using INT 10h function, known as *BIOS services*. They execute more quickly than INT 21h and let you specify the text color. When filling large screen areas, a slight delay can usually be detected. Output cannot be redirected.
- **Direct video memory access:** Characters are moved directly to video RAM, so execution is instantaneous. Output cannot be redirected. During the MS-DOS era, word processors and electronic spreadsheet programs all used this method. (Use of this method is restricted to full-screen mode under Windows NT, 2000, XP, and beyond.)

Application programs vary in their choice of which level of access to use. Those requiring the highest performance choose direct video access; others choose BIOS-level access. MS-DOS-level access is used when the output may have to be redirected or when the screen is shared with other programs. It should be mentioned that MS-DOS interrupts use BIOS-level routines to do their work, and BIOS routines use direct video access to produce their output.

### **Running Programs in Full-Screen Mode**

Programs that draw graphics using the Video BIOS should be executed in one of the following environments:

- Pure MS-DOS
- A DOS emulator under Linux
- Under MS-Windows in full-screen mode.

In MS-Windows, there are several ways to switch into full-screen mode:

- In Windows XP, create a shortcut to the program's EXE file. Then open the Properties dialog for the shortcut, select Options, and select *Full-screen mode* in the Display Options group. (Note: Windows Vista does not run 16-bit EXE programs in full-screen mode.)
- Open a Command window from the Start menu, and press Alt-Enter to switch to full screen mode. Using the CD (change directory) command, navigate to your EXE file's directory, and run the program by typing its name. Alt-Enter is a *toggle*, so if you press it again, it will return the program to Window mode.

### **Understanding Video Text**

There are two basic video modes on Intel-based systems, text mode and graphics mode. A program can run in one mode or the other, but not both at the same time:

- In *text mode*, programs write ASCII characters to the screen. The built-in character generator in the BIOS generates a bit-mapped image for each character. A program cannot draw arbitrary lines and shapes in text mode.
- In *graphics mode*, programs control the appearance of each screen pixel. The operation is somewhat primitive because there are no built-in functions for line and shape drawing. You can use built-in functions to write text to the screen in graphics mode, and you can substitute different fonts for the built-in fonts. MS-Windows provides a collection of functions for drawing shapes and lines in graphics mode.

When a computer is booted in MS-DOS, the video controller is set to Video Mode 3 (color text, defaults to 80 columns by 25 rows). In text mode, rows are numbered from the top of the screen, row 0. Each row is the height of a character cell, using the currently active font. Columns are numbered from the left side of the screen, column 0. Each column is the width of a character cell.

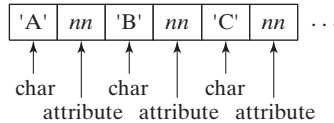
**Fonts** Characters are generated from a memory-resident table of character fonts. The BIOS permits programs to rewrite the character tables at run time, so custom fonts can be displayed.

**Video Text Pages** Text mode video memory is divided into multiple separate video pages, each able to hold a full screen of text. Programs can display one page while writing text to other hidden pages, and they can rapidly flip back and forth between pages. In the days of high-performance MS-DOS applications, it was often necessary to keep several text screens in memory at the same time. With the current popularity of graphical interfaces, this text page feature is no longer important. (INT 10h Function 05h sets the current video page, but we do not cover it in this chapter.) The default video page is page 0.

**Attributes** As illustrated in the following diagrams, each screen character is assigned an attribute byte that controls both the color of the character (called the *foreground*) and the screen color behind the character (called the *background*).



Each position on the video display holds a single character, along with its own *attribute* (color). The attribute is stored in a separate byte, following the character in memory. In the following figure, three positions on the screen contain the letters ABC:

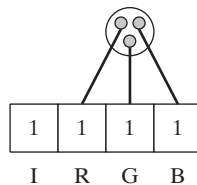


**Blinking** Characters on the video display can blink. The video controller does this by reversing the foreground and background colors of a character at a predetermined rate. By default, when a PC boots into MS-DOS mode, blinking is enabled. It is possible to turn blinking off using a video BIOS function. Also, blinking is off by default when you open up an MS-DOS emulation window under MS-Windows.

### 16.3.2 Controlling the Color

#### **Mixing Primary Colors**

Each color pixel on a CRT video display is generated using three separate electron beams: red, green, and blue. A fourth channel controls the overall intensity, or brightness of the pixel. All available text colors can therefore be represented by 4-bit binary values, in the following form (I = intensity, R = red, G = green, B = blue). The following diagram shows the composition of a white pixel:



By mixing three primary colors (Table 16-2), new colors can be generated. Furthermore, by turning on the intensity bit, you can make the mixed colors brighter.

Table 16-2 Color Mixing Example.

| Mix These Primary Colors . . . | To Get This Color | Set The Intensity Bit |
|--------------------------------|-------------------|-----------------------|
| red + green + blue             | light gray        | white                 |
| green + blue                   | cyan              | light cyan            |
| red + blue                     | magenta           | light magenta         |
| red + green                    | brown             | yellow                |
| (no colors)                    | black             | dark gray             |

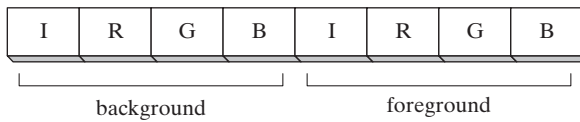
The MS-DOS-style primary colors and mixed colors are compiled into a list of all possible 4-bit colors as shown in Table 16-3. Each color in the right-hand column has its intensity bit set.

Table 16-3 Four-Bit Color Text Encoding.

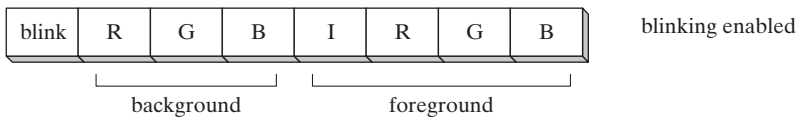
| IRGB | Color      | IRGB | Color         |
|------|------------|------|---------------|
| 0000 | black      | 1000 | gray          |
| 0001 | blue       | 1001 | light blue    |
| 0010 | green      | 1010 | light green   |
| 0011 | cyan       | 1011 | light cyan    |
| 0100 | red        | 1100 | light red     |
| 0101 | magenta    | 1101 | light magenta |
| 0110 | brown      | 1110 | yellow        |
| 0111 | light gray | 1111 | white         |

**Attribute Byte**

In color text mode, each character is assigned an attribute byte, which consists of two 4-bit color codes: background and foreground:



**Blinking** There is one complication to this simple color scheme. If the video adapter currently has blinking enabled, the high bit of the background color controls the character blinking. When this bit is set, the character blinks:



When blinking is enabled, only the low-intensity colors in the left-hand column of Table 16-3 are available as background colors (black, blue, green, cyan, red, magenta, brown, and light gray). The default color when MS-DOS boots is 00000111 binary (light gray on black background).

**Constructing Attribute Bytes** To construct a video attribute byte from two colors (foreground and background), use the assembler's SHL operator to shift the background color bits four positions to the left, and OR it with the foreground color. For example, the following statements create an attribute of light gray text on a blue background:

```
blue = 1
lightGray = 111b
mov bh, (blue SHL 4) OR lightGray ; 00010111
```

The following creates white characters on a red background:

```
white = 1111b
red = 100b
mov bh, (red SHL 4) OR white ; 01001111
```

The following lines produce blue letters on a brown background:

```
blue = 1
brown = 110b
mov bh, ((brown SHL 4) OR blue) ; 01100001
```

Fonts and colors may appear slightly different when running the same program under different operating systems. For example, in Windows 2000, XP, and beyond, blinking is disabled unless you switch to full-screen mode. The same is true for displaying graphics with INT 10h.

### 16.3.3 INT 10h Video Functions

Table 16-4 lists the most frequently used INT 10h functions. Each will be discussed separately, with its own short example. The discussion of functions 0Ch and 0Dh will be deferred to the graphics section (Section 16.4).

TABLE 16-4 Selected INT 10h Functions.

| Function Number | Description                                                                               |
|-----------------|-------------------------------------------------------------------------------------------|
| 0               | Set the video display to one of the text or graphics modes.                               |
| 1               | Set cursor lines, controlling the cursor shape and size.                                  |
| 2               | Position the cursor on the screen.                                                        |
| 3               | Get the cursor's screen position and size.                                                |
| 6               | Scroll a window on the current video page upward, replacing scrolled lines with blanks.   |
| 7               | Scroll a window on the current video page downward, replacing scrolled lines with blanks. |
| 8               | Read the character and its attribute at the current cursor position.                      |
| 9               | Write a character and its attribute at the current cursor position.                       |
| 0Ah             | Write a character at the current cursor position without changing the color attribute.    |
| 0Ch             | Write a graphics pixel on the screen in graphics mode (see Appendix C).                   |
| 0Dh             | Read the color of a single graphics pixel at a given location (see Appendix C).           |
| 0Fh             | Get video mode information.                                                               |
| 10h             | Set blink/intensity modes.                                                                |
| 13h             | Write string in teletype mode.                                                            |
| 1Eh             | Write a string to the screen in teletype mode (see Appendix C).                           |

It's a good idea to preserve the general-purpose registers (using PUSH) before calling INT 10h because the different BIOS versions are not consistent in which registers they preserve.



**Set Video Mode (00h)**

INT 10h Function 0 lets you set the current video mode to one of the text or graphics modes. Table 16-5 lists the text modes you are most likely to use:

Table 16-5 Video Text Modes Recognized by INT 10h.

| Mode           | Resolution (columns X rows) | Number of Colors |
|----------------|-----------------------------|------------------|
| 0              | 40 × 25                     | 16               |
| 1              | 40 × 25                     | 16               |
| 2              | 80 × 25                     | 16               |
| 3              | 80 × 25                     | 16               |
| 7 <sup>a</sup> | 80 × 25                     | 2                |
| 14h            | 132 × 25                    | 16               |

<sup>a</sup>Monochrome monitor.

It's a good idea to get the current video mode (INT 10h Function 0Fh) and save it in a variable before setting it to a new value. Then you can restore the original video mode when your program exits. The following table shows how to set the video mode.

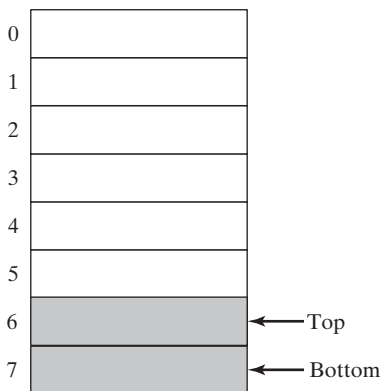
| INT 10h Function 0 |                                                                                                    |
|--------------------|----------------------------------------------------------------------------------------------------|
| <b>Description</b> | Set the video mode                                                                                 |
| <b>Receives</b>    | AH = 0<br>AL = video mode                                                                          |
| <b>Returns</b>     | Nothing                                                                                            |
| <b>Sample Call</b> | <pre>mov ah,0 mov al,3           ; video mode 3 (color text) int 10h</pre>                         |
| <b>Notes</b>       | The screen is cleared automatically unless the high bit in AL is set before calling this function. |

**Set Cursor Lines (01h)**

INT 10h Function 01h, as shown in the next table, sets the text cursor size. The text cursor is displayed using starting and ending scan lines, which make it possible to control its size. Application programs can do this to show the current status of an operation. For example, a text editor might increase the cursor size when the NumLock key is toggled on; when it is pressed again, the cursor returns to its original size.

| INT 10h Function 01h |                                                                          |
|----------------------|--------------------------------------------------------------------------|
| <b>Description</b>   | Set cursor lines                                                         |
| <b>Receives</b>      | AH = 01h<br>CH = top line<br>CL = bottom line                            |
| <b>Returns</b>       | Nothing                                                                  |
| <b>Sample Call</b>   | <pre>mov ah,1 mov cx,0607h     ; default color cursor size int 10h</pre> |
| <b>Notes</b>         | The color video display uses eight lines for its cursor.                 |

The cursor is described as a sequence of horizontal lines, where line 0 is at the top. The default color cursor starts at line 6 and ends at line 7, as shown in the following figure:



### Set Cursor Position (02h)

INT 10h Function 2 locates the cursor at a specific row and column on the video page of your choice, as seen in the following table.

| INT 10h Function 02h |                                                                                                                |
|----------------------|----------------------------------------------------------------------------------------------------------------|
| <b>Description</b>   | Set cursor position                                                                                            |
| <b>Receives</b>      | AH = 2<br>DH, DL = row, column values<br>BH = video page                                                       |
| <b>Returns</b>       | Nothing                                                                                                        |
| <b>Sample Call</b>   | <pre> mov ah,2 mov dh,10      ; row 10 mov dl,20      ; column 20 mov bh,0       ; video page 0 int 10h </pre> |
| <b>Notes</b>         | For 80 × 25 modes, DH = 0 to 24, DL = 0 to 79                                                                  |

### Get Cursor Position and Size (03h)

INT 10h Function 3, shown in the next table, returns the row/column position of the cursor as well as the starting and ending lines that determine the cursor size. This function can be quite useful in programs where the user is moving the cursor around a menu. Depending on where the cursor is, you know which menu choice has been selected.

| INT 10h Function 03h |                                                                                          |
|----------------------|------------------------------------------------------------------------------------------|
| <b>Description</b>   | Get cursor position and size                                                             |
| <b>Receives</b>      | AH = 3<br>BH = video page                                                                |
| <b>Returns</b>       | CH, CL = starting, ending cursor scan lines<br>DH, DL = row, column of cursor's location |

| INT 10h Function 03h |                                                                                                    |
|----------------------|----------------------------------------------------------------------------------------------------|
| <b>Sample Call</b>   | <pre> mov  ah,3 mov  bh,0           ; video page 0 int  10h mov  cursor,CX mov  position,DX </pre> |

**Showing and Hiding the Cursor** It is useful to be able to temporarily hide the cursor when displaying menus, writing continuously to the screen, or reading mouse input. To hide the cursor, you can set its top line value to an illegal (large) value. To redisplay the cursor, return the cursor lines to their defaults (lines 6 and 7):

```

HideCursor PROC
    mov  ah,3           ; get cursor size
    int  10h
    or   ch,30h        ; set upper row to illegal value
    mov  ah,1           ; set cursor size
    int  10h
    ret
HideCursor ENDP

ShowCursor PROC
    mov  ah,3           ; get cursor size
    int  10h
    mov  ah,1           ; set cursor size
    mov  cx,0607h      ; default size
    int  10h
    ret
ShowCursor ENDP

```

We're ignoring the possibility that the user might have set the cursor to a different size before hiding the cursor. Here's an alternate version of **ShowCursor** that simply clears the high 4 bits of CH without touching the lower 4 bits where the cursor lines are stored:

```

ShowCursor PROC
    mov  ah,3           ; get cursor size
    int  10h
    mov  ah,1           ; set cursor size
    and  ch,0Fh        ; clear high 4 bits
    int  10h
    ret
ShowCursor ENDP

```

Unfortunately, this method of hiding the cursor does not always work. An alternative method is to use INT 10h Function 02h to position the cursor off the edge of the screen (row 25, for example).

### Scroll Window Up (06h)

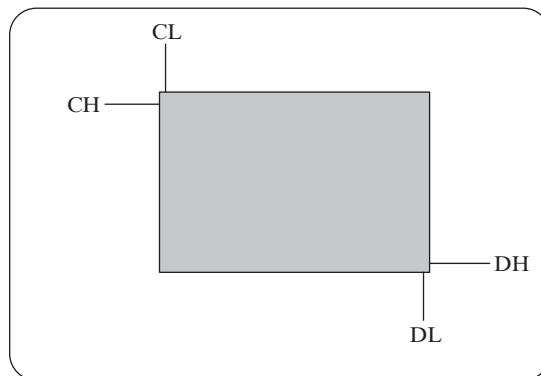
INT 10h Functions 6 scrolls all text within a rectangular area of the screen (called a *window*) upward. A *window* is defined using row and column coordinates for its upper left and lower right corners. The default MS-DOS screen has rows numbered 0 to 24 from the top and columns numbered 0 to 79 from the left. Therefore, a window covering the entire screen would be from 0,0 to 24,79. In Fig. 16-2, the

CH/CL registers define the row and column of the upper left corner and DH/DL define the row and column of the lower right corner. This function has no predictable effect on the cursor position.

As a window is scrolled up, its bottom line is replaced by a blank line. If all lines are scrolled, the window is cleared (made blank). Lines scrolled off the screen cannot be recovered. The following table describes INT 10h Function 6.

| INT 10h Function 06h |                                                                                                                                                                                                                                                                                     |
|----------------------|-------------------------------------------------------------------------------------------------------------------------------------------------------------------------------------------------------------------------------------------------------------------------------------|
| <b>Description</b>   | Scroll window up                                                                                                                                                                                                                                                                    |
| <b>Receives</b>      | AH = 6<br>AL = number of lines to scroll (0 = all)<br>BH = video attribute for blanked area<br>CH, CL = row, column of upper left window corner<br>DH, DL = row, column of lower right window corner                                                                                |
| <b>Returns</b>       | Nothing                                                                                                                                                                                                                                                                             |
| <b>Sample Call</b>   | <pre> mov ah,6      ; scroll window up mov al,0      ; entire window mov ch,0      ; upper left row mov cl,0      ; upper left column mov dh,24     ; lower right row mov dl,79     ; lower right column mov bh,7      ; attribute for blanked area int 10h      ; call BIOS </pre> |

FIGURE 16-2 Defining a Window Using INT 10h.



### Example: Writing Text to a Window

When INT 10h Function 6 (or 7) scrolls a window, it sets the attributes of the scrolled lines inside the window. If you subsequently write text inside the window using a DOS function call, the text will use the same foreground and background colors. The following program (*TextWin.asm*) demonstrates this technique:

```

TITLE Color Text Window                (TextWin.asm)
; Displays a color window and writes text inside.
INCLUDE Irvine16.inc

```

```

.data
message BYTE "Message in Window",0
.code
main PROC
    mov     ax,@data
    mov     ds,ax

; Scroll a window.
    mov     ax,0600h                ; scroll window
    mov     bh,(blue SHL 4) OR yellow ; attribute
    mov     cx,050Ah                ; upper-left corner
    mov     dx,0A30h                ; lower-right corner
    int     10h

; Position the cursor inside the window.
    mov     ah,2                    ; set cursor position
    mov     dx,0714h                ; row 7, col 20
    mov     bh,0                    ; video page 0
    int     10h

; Write some text in the window.
    mov     dx,OFFSET message
    call    WriteString

; Wait for a keypress.
    mov     ah,10h
    int     16h
    exit
main ENDP
END main

```

### Scroll Window Down (07h)

The scroll window down function is identical to Function 06h, except that the text inside the window moves downward. It uses the same input parameters.

### Read Character and Attribute (08h)

INT 10h Function 8 returns the character and its attribute at the current cursor position. It can be used by programs to read text directly off the screen (a technique known as *screen scraping*). Programs might convert the text to speech for hearing-impaired users.

| INT 10h Function 08h |                                                                                                                                                 |
|----------------------|-------------------------------------------------------------------------------------------------------------------------------------------------|
| <b>Description</b>   | Read character and attribute at current cursor position                                                                                         |
| <b>Receives</b>      | AH = 8<br>BH = video page                                                                                                                       |
| <b>Returns</b>       | AL = ASCII code of the character<br>AH = attribute of the character                                                                             |
| <b>Sample Call</b>   | <pre> mov  ah,8 mov  bh,0          ; video page 0 int  10h mov  char,al      ; save the character mov  attrib,ah    ; save the attribute </pre> |

**Write Character and Attribute (09h)**

INT 10h Function 9 writes a character in color at the current cursor position. As can be seen in the following table, this function can display any ASCII character, including the special BIOS graphics characters matching ASCII codes 1 to 31.

| INT 10h Function 09h |                                                                                                                                                                                 |
|----------------------|---------------------------------------------------------------------------------------------------------------------------------------------------------------------------------|
| <b>Description</b>   | Write character and attribute                                                                                                                                                   |
| <b>Receives</b>      | AH = 9<br>AL = ASCII code of character<br>BH = video page<br>BL = attribute<br>CX = repetition count                                                                            |
| <b>Returns</b>       | Nothing                                                                                                                                                                         |
| <b>Sample Call</b>   | <pre> mov ah,9 mov al,'A'      ; ASCII character mov bh,0       ; video page 0 mov bl,71h     ; attribute (blue on light gray) mov cx,1       ; repetition count int 10h </pre> |
| <b>Notes</b>         | Does not advance the cursor after writing the character. Can be called in text and graphics modes.                                                                              |

The *repetition count* in CX specifies how many times the character is to be repeated. (The character should not be repeated beyond the end of the current screen line.) After a character is written, you must call INT 10h Function 2 to advance the cursor if more characters will be written on the same line.

**Write Character (0Ah)**

INT 10h Function 0Ah writes a character to the screen at the current cursor position without changing the current screen attribute. As shown in the next table, it is identical to Function 9, except that the attribute is not specified.

| INT 10h Function 0Ah |                                                                        |
|----------------------|------------------------------------------------------------------------|
| <b>Description</b>   | Write character                                                        |
| <b>Receives</b>      | AH = 0Ah<br>AL = character<br>BH = video page<br>CX = repetition count |
| <b>Returns</b>       | Nothing                                                                |

| INT 10h Function 0Ah |                                                                                                                                                  |
|----------------------|--------------------------------------------------------------------------------------------------------------------------------------------------|
| <b>Sample Call</b>   | <pre> mov ah,0Ah mov al,'A'           ; ASCII character mov bh,0            ; video page 0 mov cx,1            ; repetition count int 10h </pre> |
| <b>Notes</b>         | Does not advance the cursor.                                                                                                                     |

### Get Video Mode Information (0Fh)

INT 10h Function 0Fh returns information about the current video mode, including the mode number, the number of display columns, and the active video page number, as seen in the following table. This function is useful at the beginning of a program, when you want to save the current video mode and switch to a new mode. When the program ends, you can reset the video mode (with INT 10h Function 0) to the saved value.

| INT 10h Function 0Fh |                                                                                                                                                 |
|----------------------|-------------------------------------------------------------------------------------------------------------------------------------------------|
| <b>Description</b>   | Get current video mode information                                                                                                              |
| <b>Receives</b>      | AH = 0Fh                                                                                                                                        |
| <b>Returns</b>       | AL = current display mode<br>AH = number of columns (characters or pixels)<br>BH = active video page                                            |
| <b>Sample Call</b>   | <pre> mov ah,0Fh int 10h mov vmode,al         ; save the mode mov columns,ah      ; save the columns mov page,bh         ; save the page </pre> |
| <b>Notes</b>         | Works in both text and graphics modes.                                                                                                          |

### Set Blink/Intensity Mode (10h; 03h)

INT 10h Function 10h has a number of useful subfunctions, including number 03h, which permits the highest bit of a color attribute to either control the color intensity or blink the character. See the following table for details:

| INT 10h Function 10h, Subfunction 03h |                                                                                   |
|---------------------------------------|-----------------------------------------------------------------------------------|
| <b>Description</b>                    | Set blink/intensity mode                                                          |
| <b>Receives</b>                       | AH = 10h<br>AL = 3<br>BL = blink mode (0 = enable intensity, 1 = enable blinking) |
| <b>Returns</b>                        | Nothing                                                                           |
| <b>Sample Call</b>                    | <pre> mov ah,10h mov al,3 mov bl,1             ; enable blinking int 10h </pre>   |

| INT 10h Function 10h, Subfunction 03h |                                                                                                                                                                    |
|---------------------------------------|--------------------------------------------------------------------------------------------------------------------------------------------------------------------|
| <b>Notes</b>                          | Switches on-screen text between blinking mode and high-intensity mode. Under MS-Windows, blinking can only occur when running the application in full-screen mode. |

### Write String in Teletype Mode (13h)

INT 10h Function 13h, shown in the following table, writes a string to the screen at a given row and column location. The string can optionally contain both characters and attribute values. (See the *Colorst2.asm* program in the book's sample programs folder named ch16.) This function can be used in text mode or graphics mode.

| INT 10h Function 13h |                                                                                                                                                                                                                                                                                                                                                                                                                                                                                                                                                                                                                                      |
|----------------------|--------------------------------------------------------------------------------------------------------------------------------------------------------------------------------------------------------------------------------------------------------------------------------------------------------------------------------------------------------------------------------------------------------------------------------------------------------------------------------------------------------------------------------------------------------------------------------------------------------------------------------------|
| <b>Description</b>   | Write string in teletype mode                                                                                                                                                                                                                                                                                                                                                                                                                                                                                                                                                                                                        |
| <b>Receives</b>      | AH = 13h<br>AL = write mode (see notes)<br>BH = video page<br>BL = attribute (if AL = 00h or 01h)<br>CX = string length (character count)<br>DH, DL = screen row, column<br>ES:BP = segment:offset of string                                                                                                                                                                                                                                                                                                                                                                                                                         |
| <b>Returns</b>       | Nothing                                                                                                                                                                                                                                                                                                                                                                                                                                                                                                                                                                                                                              |
| <b>Sample Call</b>   | <pre>.data colorString BYTE 'A',1Fh,'B',1Ch,'C',1Bh,'D',1Ch row        BYTE 10 column    BYTE 20 .code mov  ax,SEG colorString      ; set ES segment mov  es,ax mov  ah,13h                  ; write string mov  al,2                    ; write mode mov  bh,0                    ; video page mov  cx,(SIZEOF colorString) / 2 ; string length mov  dh,row                  ; start row mov  dl,column              ; start column mov  bp,OFFSET colorString  ; string offset int  10h</pre>                                                                                                                                      |
| <b>Notes</b>         | <p>Can be called when the display adapter is in text mode or graphics mode.</p> <p>Write mode values:</p> <ul style="list-style-type: none"> <li>• 00h = string contains only character codes; cursor not updated after write, and attribute is in BL.</li> <li>• 01h = string contains only character codes; cursor is updated after write, and attribute is in BL.</li> <li>• 02h = string contains alternating character codes and attribute bytes; cursor position not updated after write.</li> <li>• 03h = string contains alternating character codes and attribute bytes; cursor position is updated after write.</li> </ul> |



**Example: Displaying a Color String**

The following program (*ColorStr.asm*) displays a string on the console, using a different color for each character. It must be run in full-screen mode if you want to see characters blink. By default, blinking is enabled, but you can remove the call to **EnableBlinking** and see the same string on a dark gray background:

```

TITLE Color String Example                (ColorStr.asm)

INCLUDE Irvine16.inc
.data
ATTRIB_HI = 10000000b
string BYTE "ABCDEFGHIJKLMOP"
color  BYTE (black SHL 4) OR blue

.code
main PROC
    mov     ax,@data
    mov     ds,ax

    call    ClrScr
    call    EnableBlinking                ; this is optional
    mov     cx,SIZEOF string
    mov     si,OFFSET string

L1:  push   cx                            ; save loop counter
     mov   ah,9                          ; write character/attribute
     mov   al,[si]                        ; character to display
     mov   bh,0                           ; video page 0
     mov   bl,color                       ; attribute
     or    bl,ATTRIB_HI                   ; set blink/intensity bit
     mov   cx,1                           ; display it one time
     int  10h
     mov   cx,1                           ; advance cursor to
     call AdvanceCursor                  ; next screen column
     inc  color                          ; next color
     inc  si                              ; next character
     pop  cx                              ; restore loop counter
     loop L1

     call  CrLf
     exit
main ENDP

;-----
EnableBlinking PROC
;
; Enable blinking (using the high bit of color
; attributes). In MS-Windows, this only works if
; the program is running in full screen mode.
; Receives: nothing. Returns: nothing
;-----
    push  ax
    push  bx
    mov   ax,1003h                        ; set blink/intensity mode
    mov   bl,1                            ; blinking is enabled
    int  10h
    pop   bx

```

```

        pop    ax
        ret
EnableBlinking ENDP

```

The AdvanceCursor procedure can be used in any program that calls INT 10h text functions.

```

;-----
AdvanceCursor PROC
;
; Advances the cursor n columns to the right.
; (Cursor does not wrap around to the next line.)
; Receives: CX = number of columns
; Returns: nothing
;-----
        pusha
L1:     push  cx                ; save loop counter
        mov  ah,3              ; get cursor position
        mov  bh,0              ; into DH, DL
        int  10h              ; changes CX register!
        inc  dl                ; increment column
        mov  ah,2              ; set cursor position
        int  10h
        pop  cx                ; restore loop counter
        loop L1               ; next column

        popa
        ret
AdvanceCursor ENDP
END main

```

### 16.3.4 Library Procedure Examples

Let's take a look at two useful, but simple procedures from the Irvine16 link library, **Gotoxy** and **Clrscr**.

#### ***Gotoxy Procedure***

The **Gotoxy** procedure sets the cursor position on video page 0:

```

;-----
Gotoxy PROC
;
; Sets the cursor position on video page 0.
; Receives: DH,DL = row, column
; Returns: nothing
;-----
        pusha
        mov  ah,2              ; set cursor position
        mov  bh,0              ; video page 0
        int  10h
        popa
        ret
Gotoxy ENDP

```

#### ***Clrscr Procedure***

The **Clrscr** procedure clears the screen and locates the cursor at row 0, column 0 on video page 0:

```

;-----
Clrscr PROC
;
; Clears the screen (video page 0) and locates the
; cursor at row 0, column 0.
; Receives: nothing
; Returns: nothing
;-----
        pusha
        mov     ax,0600h           ; scroll entire window up
        mov     cx,0              ; upper left corner (0,0)
        mov     dx,184Fh         ; lower right corner (24,79)
        mov     bh,7              ; normal attribute
        int     10h              ; call BIOS
        mov     ah,2              ; locate cursor at 0,0
        mov     bh,0              ; video page 0
        mov     dx,0              ; row 0, column 0
        int     10h
        popa
        ret
Clrscr ENDP

```

### 16.3.5 Section Review

1. What are the three levels of access to the video display mentioned in the beginning of this section?
2. Which level of access produces the fastest output?
3. How do you run a program in full-screen mode?
4. When a computer is booted in MS-DOS, what is the default video mode?
5. Each position on the video display holds what information for a single character?
6. Which electron beams are required to generate any color on a video display?
7. Show the mapping of foreground and background colors in the video attribute byte.
8. Which INT 10h function positions the cursor on the screen?
9. Which INT 10h function scrolls a rectangular window upward?
10. Which INT 10h function writes a character and attribute at the current cursor position?
11. Which INT 10h function sets the cursor size?
12. Which INT 10h function gets the current video mode?
13. What parameters are required when setting the cursor position with INT 10h?
14. How is it possible to hide the cursor?
15. Which parameters are required when scrolling a window upward?
16. Which parameters are required when writing a character and attribute at the current cursor position?
17. Which INT 10h function sets blink/intensity modes?
18. Which values should be moved to AH and AL when clearing the screen using INT 10h function 6?

## 16.4 Drawing Graphics Using INT 10h

INT 10h Function 0Ch draws a single pixel in graphics mode. You could use it to draw complex shapes and lines, but it's unbearably slow. To learn the basics, we will start with this function and later show how to draw graphics by writing data directly to video RAM.

You can draw text on the screen using INT 10h Function 9h when the video adapter is in graphics mode.

Before drawing pixels, you have to put the video adapter into one of the standard graphics modes, shown in Table 16-6. Each mode can be set using INT 10h function 0 (set video mode).

Table 16-6 Video Graphics Modes Recognized by INT 10h.

| Mode | Resolution (Columns X Rows, in Pixels) | Number of Colors |
|------|----------------------------------------|------------------|
| 6    | 640 × 200                              | 2                |
| 0Dh  | 320 × 200                              | 16               |
| 0Eh  | 640 × 200                              | 16               |
| 0Fh  | 640 × 350                              | 2                |
| 10h  | 640 × 350                              | 16               |
| 11h  | 640 × 480                              | 2                |
| 12h  | 640 × 480                              | 16               |
| 13h  | 320 × 200                              | 256              |
| 6Ah  | 800 × 600                              | 16               |

**Coordinates** For each video mode, the resolution is expressed as *horizontal X vertical*, measured in pixels. The screen coordinates range from  $x = 0, y = 0$  in the upper left corner of the screen, to  $x = XMax - 1, y = YMax - 1$  in the lower right corner of the screen.

### 16.4.1 INT 10h Pixel-Related Functions

#### **Write Graphics Pixel (0Ch)**

INT 10h Function 0Ch, as shown in the next table, draws a pixel on the screen when the video controller is in graphics mode. Function 0Ch executes rather slowly, particularly when drawing a lot of pixels. Most graphics applications write directly into video memory after calculating the number of colors per pixel, the horizontal resolution, and so on.

| INT 10h Function 0Ch |                                                                                                                                                                                                                                                                   |
|----------------------|-------------------------------------------------------------------------------------------------------------------------------------------------------------------------------------------------------------------------------------------------------------------|
| <b>Description</b>   | Write graphics pixel                                                                                                                                                                                                                                              |
| <b>Receives</b>      | AH = 0Ch<br>AL = pixel value<br>BH = video page<br>CX = x-coordinate<br>DX = y-coordinate                                                                                                                                                                         |
| <b>Returns</b>       | Nothing                                                                                                                                                                                                                                                           |
| <b>Sample Call</b>   | <pre> mov ah,0Ch mov al,pixelValue mov bh,videoPage mov cx,x_coord mov dx,y_coord int 10h </pre>                                                                                                                                                                  |
| <b>Notes</b>         | The video display must be in graphics mode. The range of pixel values and the coordinate ranges depend on the current graphics mode. If bit 7 is set in AL, the new pixel will be XORed with the current contents of the pixel (allowing the pixel to be erased). |

### Read Graphics Pixel (0Dh)

Function 0Dh, shown as follows, reads a graphics pixel from the screen at a given row and column position and returns the pixel value in AL.

| INT 10h Function 0Dh |                                                                                                                                      |
|----------------------|--------------------------------------------------------------------------------------------------------------------------------------|
| <b>Description</b>   | Read graphics pixel                                                                                                                  |
| <b>Receives</b>      | AH = 0Dh<br>BH = video page<br>CX = x-coordinate<br>DX = y-coordinate                                                                |
| <b>Returns</b>       | AL = pixel value                                                                                                                     |
| <b>Sample Call</b>   | <pre> mov  ah,0Dh mov  bh,0           ; video page 0 mov  cx,x_coord mov  dx,y_coord int  10h mov  pixelValue,al </pre>              |
| <b>Notes</b>         | The video display must be in graphics mode. The range of pixel values and the coordinate ranges depend on the current graphics mode. |

#### 16.4.2 DrawLine Program

The *DrawLine* program switches into graphics mode using INT 10h, writes the name of the program in text, and draws a straight horizontal line. If you run it in MS-Windows, switch the console window to full-screen mode by pressing Alt-Enter.<sup>2</sup> Following is the complete program listing:

```

TITLE DrawLine Program                (DrawLine.asm)
; This program draws text and a straight line in graphics mode.
INCLUDE Irvine16.inc
;----- Video Mode Constants -----
Mode_06 = 6           ; 640 X 200,  2 colors
Mode_0D = 0Dh        ; 320 X 200, 16 colors
Mode_0E = 0Eh        ; 640 X 200, 16 colors
Mode_0F = 0Fh        ; 640 X 350,  2 colors
Mode_10 = 10h        ; 640 X 350, 16 colors
Mode_11 = 11h        ; 640 X 480,  2 colors
Mode_12 = 12h        ; 640 X 480, 16 colors
Mode_13 = 13h        ; 320 X 200, 256 colors
Mode_6A = 6Ah        ; 800 X 600, 16 colors

.data
saveMode  BYTE  ?           ; save the current video mode
currentX  WORD  100         ; column number (X-coordinate)
currentY  WORD  100         ; row number (Y-coordinate)
COLOR     = 1001b          ; line color (cyan)

progTitle BYTE "DrawLine.asm"
TITLE_ROW = 5
TITLE_COLUMN = 14

; When using a 2-color mode, set COLOR to 1 (white)

.code

```

```

main PROC
    mov     ax,@data
    mov     ds,ax

; Save the current video mode.
    mov     ah,0Fh
    int     10h
    mov     saveMode,al

; Switch to a graphics mode.
    mov     ah,0             ; set video mode
    mov     al,Mode_6A
    int     10h

; Write the program name, as text.
    mov     ax,SEG progTitle ; get segment of progTitle
    mov     es,ax           ; store in ES
    mov     bp,OFFSET progTitle
    mov     ah,13h         ; function: write string
    mov     al,0           ; mode: only character codes
    mov     bh,0           ; video page 0
    mov     bl,7           ; attribute = normal
    mov     cx,SIZEOF progTitle ; string length
    mov     dh,TITLE_ROW   ; row (in character cells)
    mov     dl,TITLE_COLUMN ; column (in character cells)
    int     10h

; Draw a straight line.
    LineLength = 100
    mov     dx,currentY
    mov     cx,LineLength ; loop counter

L1:
    push    cx
    mov     ah,0Ch         ; write pixel
    mov     al,COLOR      ; pixel color
    mov     bh,0           ; video page 0
    mov     cx,currentX
    int     10h
    inc     currentX
    ;inc    color         ; enable to see a multi-color line
    pop     cx
    Loop   L1

; Wait for a keystroke.
    mov     ah,0
    int     16h

; Restore the starting video mode.
    mov     ah,0             ; set video mode
    mov     al,saveMode     ; saved video mode
    int     10h
    exit
main ENDP
END main

```

*Changing the Video Mode* You can try out different graphics modes by modifying a single program statement that currently selects video Mode 6Ah:

```

mov  ah,0                ; set video mode
mov  al,Mode_6A          ; modify for different modes
int  10h                 ; call BIOS routine

```

### 16.4.3 Cartesian Coordinates Program

The *Cartesian Coordinates* program draws the X and Y axes of a Cartesian coordinate system, with the intersection point at screen locations X = 400 and Y = 300. There are two important procedures, **DrawHorizLine** and **DrawVerticalLine**, which could easily be inserted in other graphics programs. The program sets the video adapter to Mode 6Ah (800 × 600, 16 colors).

```

TITLE Cartesian Coordinates                (Pixel2.asm)

; This program switches into 800 X 600 graphics mode and
; draws the X and Y axes of a Cartesian coordinate system.
; Switch to full-screen mode before running this program.
; Color constants are defined in Irvine16.inc.

INCLUDE Irvine16.inc

Mode_6A = 6Ah                ; 800 X 600, 16 colors
X_axisY = 300
X_axisX = 50
X_axisLen = 700

Y_axisX = 400
Y_axisY = 30
Y_axisLen = 540

.data
saveMode BYTE ?

.code
main PROC
    mov  ax,@data
    mov  ds,ax

; Save the current video mode
    mov  ah,0Fh                ; get video mode
    int  10h
    mov  saveMode,al

; Switch to a graphics mode
    mov  ah,0                ; set video mode
    mov  al,Mode_6A          ; 800 X 600, 16 colors
    int  10h

; Draw the X-axis
    mov  cx,X_axisX          ; X-coord of start of line
    mov  dx,X_axisY          ; Y-coord of start of line
    mov  ax,X_axisLen        ; length of line
    mov  bl,white            ; line color (see IRVINE16.inc)
    call DrawHorizLine      ; draw the line now

; Draw the Y-axis
    mov  cx,Y_axisX          ; X-coord of start of line
    mov  dx,Y_axisY          ; Y-coord of start of line
    mov  ax,Y_axisLen        ; length of line
    mov  bl,white            ; line color
    call DrawVerticalLine   ; draw the line now

```

```

; Wait for a keystroke
mov  ah,10h          ; wait for key
int  16h

; Restore the starting video mode
mov  ah,0           ; set video mode
mov  al,saveMode    ; saved video mode
int  10h

    exit
main endp

;-----
DrawHorizLine PROC
;
; Draws a horizontal line starting at position X,Y with
; a given length and color.
; Receives: CX = X-coordinate, DX = Y-coordinate,
;          AX = length, and BL = color
; Returns: nothing
;-----
.data
currX WORD ?
.code
    pusha
    mov  currX,cx    ; save X-coordinate
    mov  cx,ax      ; loop counter

DHL1:
    push cx          ; save loop counter
    mov  al,bl       ; color
    mov  ah,0Ch      ; draw pixel
    mov  bh,0        ; video page
    mov  cx,currX    ; retrieve X-coordinate
    int  10h
    inc  currX       ; move 1 pixel to the right
    pop  cx          ; restore loop counter
    loop DHL1

    popa
    ret
DrawHorizLine ENDP

;-----
DrawVerticalLine PROC
;
; Draws a vertical line starting at position X,Y with
; a given length and color.
; Receives: CX = X-coordinate, DX = Y-coordinate,
;          AX = length, BL = color
; Returns: nothing
;-----
.data
currY WORD ?
.code
    pusha
    mov  currY,dx    ; save Y-coordinate
    mov  currX,cx    ; save X-coordinate
    mov  cx,ax      ; loop counter

```



```

DVL1:
    push    cx                ; save loop counter
    mov     al,b1             ; color
    mov     ah,0Ch           ; function: draw pixel
    mov     bh,0             ; set video page
    mov     cx,currX         ; set X-coordinate
    mov     dx,currY         ; set Y-coordinate
    int    10h              ; draw the pixel
    inc     currY            ; move down 1 pixel
    pop     cx                ; restore loop counter
    loop   DVL1

    popa
    ret
DrawVerticalLine ENDP
END main

```

#### 16.4.4 Converting Cartesian Coordinates to Screen Coordinates

Points on a Cartesian graph do not correspond to the absolute coordinates used by the BIOS graphics system. In the preceding two program examples, it was clear that screen coordinates begin at  $sx = 0$ ,  $sy = 0$  in the upper left corner of the screen.  $sx$  values grow to the right, and  $sy$  values grow toward the bottom of the screen. You can use the following formulas to convert Cartesian  $X$ ,  $Y$  to screen coordinates  $sx$ ,  $sy$ :

$$sx = (sOrigX + X) \qquad sy = (sOrigY - Y)$$

where  $sOrigX$  and  $sOrigY$  are the screen coordinates of the origin of the Cartesian coordinate system. In the Cartesian Coordinates Program (Section 16.4.3), our lines intersected at  $sOrigX = 400$  and  $sOrigY = 300$ , placing the origin in the middle of the screen. If we use the four points in Fig. 16-3 to test the given conversion formulas, Table 16-7 shows the results of the calculations.

FIGURE 16-3 Test Coordinates for Conversion Formulas.

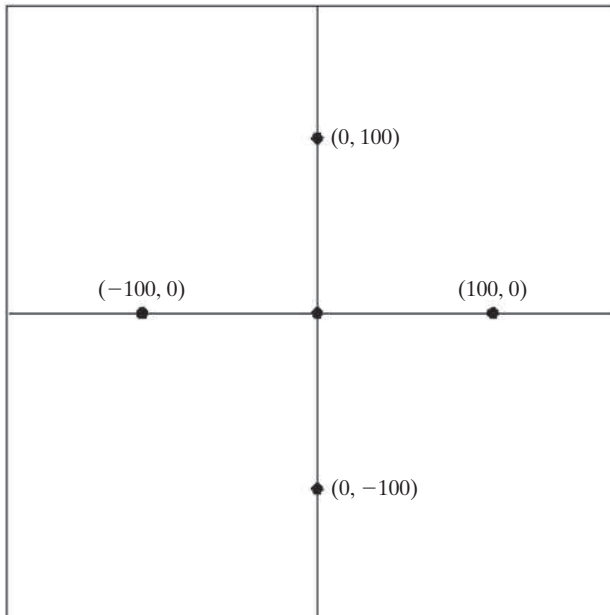


TABLE 16-7 Testing the Conversion Formulas.

| Cartesian (X, Y) | (400 + X, 300 - Y)      | Screen (sx, sy) |
|------------------|-------------------------|-----------------|
| (0, 100)         | (400 + 0, 300 - 100)    | (400, 200)      |
| (100, 0)         | (400 + 100, 300 - 0)    | (500, 300)      |
| (0, -100)        | (400 + 0, 300 - (-100)) | (400, 400)      |
| (-100, 0)        | (400 + (-100), 300 - 0) | (300, 300)      |

### 16.4.5 Section Review

- Which INT 10h function draws a single pixel on the video display?
- When using INT 10h to draw a single pixel, what values must be placed in the AL, BH, CX, and DX registers?
- What is the main disadvantage to drawing pixels using INT 10h?
- Write ASM statements that set the video adapter to Mode 11h.
- Which video mode is  $800 \times 600$  pixels, in 16 colors?
- What is the formula to convert a Cartesian X-coordinate to screen pixel coordinates? (Use the variable *sx* for the screen column, and use *sOrigX* for the screen column where the Cartesian origin point (0, 0) is located.)
- If a Cartesian origin point is located at screen coordinates  $sy = 250$ ,  $sx = 350$ , convert the following Cartesian points in the form (X, Y) into screen coordinates (*sx*, *sy*):
  - (0, 100)
  - (25, 25)
  - (-200, -150)

## 16.5 Memory-Mapped Graphics

We have seen how drawing pixels using INT 10h is unbearably slow except for the most rudimentary graphics output. Quite a lot of code executes each time the BIOS draws a pixel. Now we can show you a more efficient way to draw graphics, as done by professional software. We will write graphics data directly to video RAM (VRAM) via input–output ports.

### 16.5.1 Mode 13h: 320 X 200, 256 Colors

Video Mode 13h is the easiest mode to use for memory-mapped graphics. Screen pixels are mapped as a two-dimensional array of bytes, 1 byte per pixel. The array begins with the pixel in the upper left corner of the screen and continues across the top line for 320 bytes. The byte at offset 320 maps to the first pixel in the second screen line, which continues sequentially across the screen. The remaining lines are mapped in a similar fashion. The last byte in the array is mapped to the pixel in the lower right corner of the screen. Why use a whole byte for each pixel? Because the byte holds a reference to one of 256 different color values.

**OUT Instruction** Pixel and color values are transmitted to the video adapter hardware using the OUT (output to port) instruction. The 16-bit port address is assigned to DX, and the value sent to the port is in AL, AX, or EAX. For example, the video color palette is located at port address 3C8h. The following instructions send the value 20h to the port:

```

mov  dx,3c8h           ; port address
mov  al,20h           ; value to be output
out  dx,al            ; send value to port

```

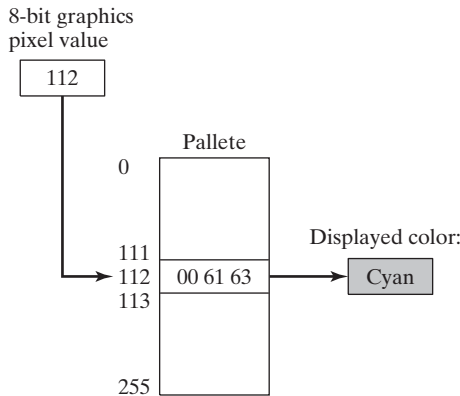
**Color Indexes** The interesting thing about colors in Mode 13h is that each color integer does not directly indicate a color. Instead, it represents an index into a table of colors called a *palette* (Fig. 16-4). Each entry in the palette consists of three integer values (0 to 63) known as *RGB* (red, green, blue). Entry 0 in the color palette controls the screen's background color.

You can create 262,144 different colors ( $64^3$ ) with this scheme. Only 256 different colors can be displayed at a given time, but your program can modify the palette at run time to vary the display colors. Modern operating systems such as Windows and Linux offer (at least) 24-bit color, in which each RGB value has a range of 0 to 255. That scheme offers  $256^3$  (16.7 million) different colors.

**RGB Colors**

RGB colors are based on the additive mixing of light, as opposed to the subtractive method one uses when mixing liquid paint. With additive mixing, for example, you create the color black by keeping all color intensity levels at zero. White, on the other hand, is created by setting all color levels at 63

FIGURE 16-4 Converting Pixel Color Indexes to Display Colors.



(the maximum). In fact, as the following table demonstrates, when all three levels are equal, you get varying shades of gray:

| Red | Green | Blue | Color       |
|-----|-------|------|-------------|
| 0   | 0     | 0    | black       |
| 20  | 20    | 20   | dark gray   |
| 35  | 35    | 35   | medium gray |
| 50  | 50    | 50   | light gray  |
| 63  | 63    | 63   | white       |

Pure colors are created by setting all but one color level to zero. To get a light color, increase the other two colors in equal amounts. Here are variations on the color red:

| Red | Green | Blue | Color      |
|-----|-------|------|------------|
| 63  | 0     | 0    | bright red |
| 10  | 0     | 0    | dark red   |
| 30  | 0     | 0    | medium red |
| 63  | 40    | 40   | pink       |

Bright blue, dark blue, light blue, bright green, dark green, and light green are created in a similar manner. Of course, you can mix pairs of colors in other amounts to create colors such as magenta and lavender. Following are examples:

| Red | Green | Blue | Color    |
|-----|-------|------|----------|
| 0   | 30    | 30   | cyan     |
| 30  | 30    | 0    | yellow   |
| 30  | 0     | 30   | magenta  |
| 40  | 0     | 63   | lavender |

### 16.5.2 Memory-Mapped Graphics Program

The *Memory-Mapped Graphics* program introduced next draws a row of 10 pixels on the screen using direct memory mapping in Mode 13h. The main procedure calls procedures that set the video mode to Mode 13h, set the screen's background color, draw some color pixels, and restore the video adapter to its starting mode. Two output ports control the video color palette. The value sent to port 3C8h indicates which video palette entry you plan to change. Then the color values themselves are sent to port 3C9h. Here is the program listing:

```

; Memory Mapped Graphics, Mode 13           (Mode13.asm)
INCLUDE Irvine16.inc
VIDEO_PALLETE_PORT = 3C8h
COLOR_SELECTION_PORT = 3C9h
COLOR_INDEX = 1
PALLETE_INDEX_BACKGROUND = 0
SET_VIDEO_MODE = 0
GET_VIDEO_MODE = 0Fh
VIDEO_SEGMENT = 0A000h
WAIT_FOR_KEYSTROKE = 10h
MODE_13 = 13h

.data
saveMode BYTE ?           ; saved video mode
xVal WORD ?              ; x-coordinate
yVal WORD ?              ; y-coordinate
msg BYTE "Welcome to Mode 13!",0

.code
main PROC
    mov     ax,@data
    mov     ds,ax

    call    SetVideoMode
    call    SetScreenBackground

; Display a greeting message.
    mov     edx,OFFSET msg
    call    WriteString

    call    Draw_Some_Pixels
    call    RestoreVideoMode
    exit
main ENDP

```

```

;-----
SetScreenBackground PROC
;
; Sets the screen's background color. Video
; palette index 0 is the background color.
;-----
    mov     dx,VIDEO_PALLETE_PORT
    mov     al,PALLETE_INDEX_BACKGROUND
    out     dx,al

; Set the screen background color to dark blue.

    mov     dx,COLOR_SELECTION_PORT
    mov     al,0                ; red
    out     dx,al
    mov     al,0                ; green
    out     dx,al
    mov     al,35               ; blue (intensity 35/63)
    out     dx,al

    ret
SetScreenBackground endp

;-----
SetVideoMode PROC
;
; Saves the current video mode, switches to a
; new mode, and points ES to the video segment.
;-----
    mov     ah,GET_VIDEO_MODE
    int     10h
    mov     saveMode,al        ; save it

    mov     ah,SET_VIDEO_MODE
    mov     al,MODE_13        ; to mode 13h
    int     10h

    push    VIDEO_SEGMENT     ; video segment address
    pop     es                 ; ES points to video segment

    ret
SetVideoMode ENDP

;-----
RestoreVideoMode PROC
;
; Waits for a key to be pressed and restores
; the video mode to its original value.
;-----
    mov     ah,WAIT_FOR_KEYSTROKE
    int     16h
    mov     ah,SET_VIDEO_MODE ; reset video mode
    mov     al,saveMode       ; to saved mode
    int     10h
    ret
RestoreVideoMode ENDP

;-----
Draw_Some_Pixels PROC

```

```

;
; Sets individual palette colors and draws
; several pixels.
;-----
; Change the color at index 1 to white (63,63,63).
    mov     dx,VIDEO_PALLETE_PORT
    mov     al,1                ; set palette index 1
    out     dx,al

    mov     dx,COLOR_SELECTION_PORT
    mov     al,63               ; red
    out     dx,al
    mov     al,63               ; green
    out     dx,al
    mov     al,63               ; blue
    out     dx,al

; Calculate the video buffer offset of the first pixel.
; Method is specific to mode 13h, which is 320 X 200.
    mov     xVal,160            ; middle of screen
    mov     yVal,100
    mov     ax,320              ; 320 for video mode 13h
    mul     yVal                ; y-coordinate
    add     ax,xVal             ; x-coordinate

; Place the color index into the video buffer.
    mov     cx,10               ; draw 10 pixels
    mov     di,ax               ; AX contains buffer offset

; Draw the pixels now. By default, the assembler assumes
; DI is an offset from the segment address in DS. The
; segment override ES:[DI] tells the CPU to use the segment
; address in ES instead. ES currently points to VRAM.
DP1:
    mov     BYTE PTR es:[di],COLOR_INDEX
    add     di,5                ; move 5 pixels to the right
    loop   DP1

    ret
Draw_Some_Pixels ENDP
END main

```

This program is fairly easy to implement because the pixels happen to be on the same screen line. To draw a vertical line, on the other hand, you could add 320 to each value of DI to move to the next row of pixels. Or, a diagonal line with slope  $-1$  could be drawn by adding 321 to DI. Drawing arbitrary lines between any two points is best handled by *Bresenham's Algorithm*, which is well-explained on many web sites.

### 16.5.3 Section Review

1. (*True/False*): Video mode 13h maps screen pixels as a two-dimensional array of bytes, where each byte corresponds to two pixels.
2. (*True/False*): In video mode 13h, each screen row uses 320 bytes of storage.

3. In one sentence, explain how video mode 13h sets the colors of pixels.
4. How is the color index used in video mode 13h?
5. In video mode 13h, what is contained in each element of the color palette?
6. What are the three RGB values for dark gray?
7. What are the three RGB values for white?
8. What are the three RGB values for bright red?
9. *Challenge:* Show how to set the screen background color in video mode 13h to green.
10. *Challenge:* Show how to set the screen background color in video mode 13h to white.

## 16.6 Mouse Programming

The mouse is usually connected to the computer's motherboard through a PS-2 mouse port, RS-232 serial port, USB port, or wireless connection. Before detecting the mouse, MS-DOS requires a device driver program to be installed. MS-Windows also has built-in mouse drivers, but for now we will concentrate on functions provided by MS-DOS.

Mouse movements are tracked in a unit of measure called *mickeys* (guess how they came up with that name?). One mickey represents approximately 1/200 inch of physical mouse travel. The mickeys-to-pixels ratio can be set for the mouse, which defaults to 8 mickeys for each 8 horizontal pixels and 16 mickeys for each 8 vertical pixels.<sup>3</sup> There is also a double-speed threshold, which defaults to 64 mickeys per second.

### 16.6.1 Mouse INT 33h Functions

INT 33h provides information about the mouse, including its current position, last button clicked, speed, and so on. You can also use it to display or hide the mouse cursor. In this section, we cover a few of the more essential mouse functions. INT 33h receives the function number in the AX register rather than AH (which is the norm for BIOS interrupts).

#### ***Reset Mouse and Get Status***

INT 33h Function 0 resets the mouse and confirms that it is available. The mouse (if found) is centered on the screen, its display page is set to video page 0, its pointer is hidden, and its mickeys-to-pixels ratios and speed are set to default values. The mouse's range of movement is set to the entire screen area. Details are shown in the following table:

| INT 33h Function 0 |                                                                                               |
|--------------------|-----------------------------------------------------------------------------------------------|
| <b>Description</b> | Reset mouse and get status                                                                    |
| <b>Receives</b>    | AX = 0                                                                                        |
| <b>Returns</b>     | If mouse support is available AX = FFFFh and BX = number of mouse buttons; otherwise, AX = 0. |
| <b>Sample Call</b> | <pre> mov ax,0 int 33h cmp ax,0 je MouseNotAvailable mov numberOfButtons,bx </pre>            |
| <b>Notes</b>       | If the mouse was visible before this call, it is hidden by this function.                     |

### Showing and Hiding the Mouse Pointer

INT 33h Functions 1 and 2, shown in the next two tables, display and hide the mouse pointer, respectively. The mouse driver keeps an internal counter, which is incremented (if nonzero) by calls to Function 1 and decremented by calls to Function 2. When the counter is non-negative, the mouse pointer is displayed. Function 0 (reset mouse pointer) sets the counter to  $-1$ .

| INT 33h Function 1 |                                                                                                                          |
|--------------------|--------------------------------------------------------------------------------------------------------------------------|
| <b>Description</b> | Show mouse pointer                                                                                                       |
| <b>Receives</b>    | AX = 1                                                                                                                   |
| <b>Returns</b>     | Nothing                                                                                                                  |
| <b>Sample Call</b> | <pre>mov ax,1 int 33h</pre>                                                                                              |
| <b>Notes</b>       | The mouse driver keeps a count of the number of times this function is called. Adds 1 to its internal show/hide counter. |

| INT 33h Function 2 |                                                                                                          |
|--------------------|----------------------------------------------------------------------------------------------------------|
| <b>Description</b> | Hide mouse pointer                                                                                       |
| <b>Receives</b>    | AX = 2                                                                                                   |
| <b>Returns</b>     | Nothing                                                                                                  |
| <b>Sample Call</b> | <pre>mov ax,2 int 33h</pre>                                                                              |
| <b>Notes</b>       | The mouse driver continues to track the mouse position. Subtracts 1 from its internal show/hide counter. |

### Get Mouse Position and Status

INT 33h Function 3 gets the mouse position and mouse status, shown in the following table:

| INT 33h Function 3 |                                                                                                                                                                                        |
|--------------------|----------------------------------------------------------------------------------------------------------------------------------------------------------------------------------------|
| <b>Description</b> | Get mouse position and status                                                                                                                                                          |
| <b>Receives</b>    | AX = 3                                                                                                                                                                                 |
| <b>Returns</b>     | BX = mouse button status<br>CX = X-coordinate (in pixels)<br>DX = Y-coordinate (in pixels)                                                                                             |
| <b>Sample Call</b> | <pre>mov ax,3 int 33h test bx,1 jne Left_Button_Down test bx,2 jne Right_Button_Down test bx,4 jne Center_Button_Down mov Xcoord,cx mov yCoord,dx</pre>                                |
| <b>Notes</b>       | The mouse button status is returned in BX as follows: If bit 0 is set, the left button is down; if bit 1 is set, the right button is down; if bit 2 is set, the center button is down. |



**Converting Pixel to Character Coordinates** Standard text fonts in MS-DOS are 8 pixels wide and 16 pixels high, so you can convert pixel coordinates to character coordinates by dividing the former by the character size. Assuming that both pixels and characters start numbering at zero, the following formula converts a pixel coordinate P to a character coordinate C, using character dimension D:

$$C = \text{int}(P / D)$$

For example, let's assume that characters are 8 pixels wide. If the X-coordinate returned by INT 33 Function 3 was 100 (pixels), the coordinate would fall within character position 12:  $C = \text{int}(100 / 8)$ .

### Set Mouse Position

INT 33h Function 4, shown in the following table, moves the mouse position to specified X and Y pixel coordinates.

| INT 33h Function 4 |                                                                                                  |
|--------------------|--------------------------------------------------------------------------------------------------|
| <b>Description</b> | Set mouse position                                                                               |
| <b>Receives</b>    | AX = 4<br>CX = X-coordinate (in pixels)<br>DX = Y-coordinate (in pixels)                         |
| <b>Returns</b>     | Nothing                                                                                          |
| <b>Sample Call</b> | <pre> mov ax,4 mov cx,200           ; X-position mov dx,100          ; Y-position int 33h </pre> |
| <b>Notes</b>       | If the position lies within an exclusion area, the mouse is not displayed.                       |

**Converting Character to Pixel Coordinates** You can convert a screen character coordinate to a pixel coordinate using the following formula, where C = character coordinate, P = pixel coordinate, and D = character dimension:

$$P = C \times D$$

In the horizontal direction, P will be the pixel coordinate of the left side of the character cell. In the vertical direction, P will be the pixel coordinate of the top of the character cell. If characters are 8 pixels wide, and you want to put the mouse in character cell 12, for example, the X-coordinate of the leftmost pixel of that cell is 96.

### Get Button Presses and Releases

Function 5 returns the status of all mouse buttons, as well as the position of the last button press. In an event-driven programming environment, a *drag* event always begins with a button press. Once a call is made to this function for a particular button, the button's state is reset, and a second call to the function returns nothing:

| INT 33h Function 5 |                                                                                                                                     |
|--------------------|-------------------------------------------------------------------------------------------------------------------------------------|
| <b>Description</b> | Get button press information                                                                                                        |
| <b>Receives</b>    | AX = 5<br>BX = button ID (0 = left, 1 = right, 2 = center)                                                                          |
| <b>Returns</b>     | AX = button status<br>BX = button press counter<br>CX = X-coordinate of last button press<br>DX = Y-coordinate of last button press |

| INT 33h Function 5 |                                                                                                                                                                                         |
|--------------------|-----------------------------------------------------------------------------------------------------------------------------------------------------------------------------------------|
| <b>Sample Call</b> | <pre> mov ax,5 mov bx,0           ; button ID int 33h test ax,1         ; left button down? jz  skip         ; no - skip mov X_coord,cx   ; yes: save coordinates mov Y_coord,dx </pre> |
| <b>Notes</b>       | The mouse button status is returned in AX as follows: If bit 0 is set, the left button is down; if bit 1 is set, the right button is down; if bit 2 is set, the center button is down.  |

Function 6 gets button release information from the mouse, as shown in the following table. In event-driven programming, a mouse *click* event occurs when a mouse button is released. Similarly, a *drag* event ends when the mouse button is released.

| INT 33h Function 6 |                                                                                                                                                                                                       |
|--------------------|-------------------------------------------------------------------------------------------------------------------------------------------------------------------------------------------------------|
| <b>Description</b> | Get button release information                                                                                                                                                                        |
| <b>Receives</b>    | AX = 6<br>BX = button ID (0 = left, 1 = right, 2 = center)                                                                                                                                            |
| <b>Returns</b>     | AX = button status<br>BX = button release counter<br>CX = X-coordinate of last button release<br>DX = Y-coordinate of last button release                                                             |
| <b>Sample Call</b> | <pre> mov ax,6 mov bx,0           ; button ID int 33h test ax,1         ; left button released? jz  skip         ; no - skip mov X_coord,cx   ; yes: save coordinates mov Y_coord,dx </pre>           |
| <b>Notes</b>       | The mouse button status is returned in AX as follows: If bit 0 is set, the left button was released; if bit 1 is set, the right button was released; if bit 2 is set, the center button was released. |

### Setting Horizontal and Vertical Limits

INT 33h Functions 7 and 8, as illustrated in the next two tables, let you set limits on where the mouse pointer can go on the screen. You do this by setting minimum and maximum coordinates for the mouse cursor. If necessary, the mouse pointer is moved so it lies within the new limits.

| INT 33h Function 7 |                                                                                          |
|--------------------|------------------------------------------------------------------------------------------|
| <b>Description</b> | Set horizontal limits                                                                    |
| <b>Receives</b>    | AX = 7<br>CX = minimum X-coordinate (in pixels)<br>DX = maximum X-coordinate (in pixels) |
| <b>Returns</b>     | Nothing                                                                                  |

| INT 33h Function 7 |                                                                                                     |
|--------------------|-----------------------------------------------------------------------------------------------------|
| <b>Sample Call</b> | <pre> mov ax,7 mov cx,100           ; set X-range to mov dx,700          ; (100,700) int 33h </pre> |

| INT 33h Function 8 |                                                                                                            |
|--------------------|------------------------------------------------------------------------------------------------------------|
| <b>Description</b> | Set vertical limits                                                                                        |
| <b>Receives</b>    | AX = 8<br>CX = minimum Y-coordinate (in pixels)<br>DX = maximum Y-coordinate (in pixels)                   |
| <b>Returns</b>     | Nothing                                                                                                    |
| <b>Sample Call</b> | <pre> mov ax,8 int 33h mov cx,100          ; set Y-range to mov dx,500          ; (100,500) int 33h </pre> |

### Miscellaneous Mouse Functions

A number of other INT 33h functions are useful for configuring the mouse and controlling its behavior. We don't have the space to elaborate on these functions, but they are listed in Table 16-8.

Table 16-8 Miscellaneous Mouse Functions.

| Function | Description                                                                       | Input/Output Parameters                                                                                                                                                                                   |
|----------|-----------------------------------------------------------------------------------|-----------------------------------------------------------------------------------------------------------------------------------------------------------------------------------------------------------|
| AX = 0Fh | Sets the number of mickeys per 8 pixels for horizontal and vertical mouse motion. | Receives: CX = horizontal mickeys, DX = vertical mickeys. The defaults are CX = 8, DX = 16.                                                                                                               |
| AX = 10h | Set mouse exclusion area (prevents mouse from entering a rectangle).              | Receives: CX, DX = X, Y coordinates of upper left corner. SI, DI = X, Y coordinates of lower right corner                                                                                                 |
| AX = 13h | Set double speed threshold.                                                       | Receives: DX = threshold speed in mickeys per second (the default is 64)                                                                                                                                  |
| AX = 1Ah | Set mouse sensitivity and threshold.                                              | Receives: BX = horizontal speed (mickeys per second), CX = vertical speed (mickeys per second), DX = double speed threshold in mickeys per second                                                         |
| AX = 1Bh | Get mouse sensitivity and threshold.                                              | Returns: BX = horizontal speed, CX = vertical speed, DX = double speed threshold                                                                                                                          |
| AX = 1Fh | Disable mouse driver.                                                             | Returns: If unsuccessful, AX = FFFFh                                                                                                                                                                      |
| AX = 20h | Enable mouse driver.                                                              | None                                                                                                                                                                                                      |
| AX = 24h | Get mouse information.                                                            | Returns FFFFh on error; otherwise, returns: BH = major version number, BL = minor version number, CH = mouse type (1 = bus, 2 = serial, 3 = InPort, 4 = PS/2, 5 = HP); CL = IRQ number (0 for PS/2 mouse) |

## 16.6.2 Mouse Tracking Program

We've written a simple *mouse tracking* program that tracks the movement of the text mouse cursor. The X and Y coordinates are continually updated in the lower-right corner of the screen, and when the user presses the left button, the mouse's position is displayed in the lower left corner of the screen. Following is the source code:

```

TITLE Tracking the Mouse                                (mouse.asm)

; Demonstrates basic mouse functions available via INT 33h.
; In Standard DOS mode, each character position in the DOS
; window equals 8 mouse units.

INCLUDE Irvine16.inc

GET_MOUSE_STATUS = 0
SHOW_MOUSE_POINTER = 1
HIDE_MOUSE_POINTER = 2
GET_CURSOR_SIZE = 3
GET_BUTTON_PRESS_INFO = 5
GET_MOUSE_POSITION_AND_STATUS = 3
ESCkey = 1Bh

.data
greeting    BYTE "[Mouse.exe] Press Esc to quit",0
statusLine  BYTE "Left button: "
            BYTE "Mouse position: ",0
blanks      BYTE "          ",0
xCoord     WORD 0                ; current X-coordinate
yCoord     WORD 0                ; current Y-coordinate
xPress     WORD 0                ; X-coord of last button press
yPress     WORD 0                ; Y-coord of last button press

; Display coordinates.
statusRow   BYTE ?
statusCol   BYTE 15
buttonPressCol BYTE 20
statusCol2  BYTE 60
coordCol    BYTE 65

.code
main PROC
    mov     ax,@data
    mov     ds,ax
    call    Clrscr

; Get the screen X/Y coordinates.
    call   GetMaxXY           ; DH = rows, DL = columns
    dec    dh                 ; calculate status row value
    mov    statusRow,dh

; Hide the text cursor and display the mouse.
    call   HideCursor
    mov    dx,OFFSET greeting
    call   WriteString
    call   ShowMousePointer

; Display status information on the bottom screen line.
    mov    dh,statusRow

```

```

        mov     dl,0
        call   Gotoxy
        mov     dx,OFFSET statusLine
        call   Writestring

; Loop: show mouse coordinates, check for left mouse
; button press or keypress (Esc key).
L1:  call   ShowMousePosition
     call   LeftButtonPress      ; check for button press
     mov    ah,11h                ; key pressed already?
     int    16h
     jz     L2                    ; no, continue the loop
     mov    ah,10h                ; remove key from buffer
     int    16h
     cmp    al,ESCkey            ; yes. Is it the ESC key?
     je     quit                 ; yes, quit the program
L2:  jmp    L1                    ; no, continue the loop

; Hide the mouse, restore the text cursor, clear
; the screen, and wait for a key press.
quit:
     call   HideMousePointer
     call   ShowCursor
     call   Clrscr
     call   WaitMsg
     exit
main ENDP

;-----
GetMousePosition PROC USES ax
;
; Gets the current mouse position and button status.
; Receives: nothing
; Returns:  BX = button status (0 = left button down,
;           (1 = right button down, 2 = center button down)
;           CX = X-coordinate
;           DX = Y-coordinate
;-----
     mov    ax,GET_MOUSE_POSITION_AND_STATUS
     int    33h
     ret
GetMousePosition ENDP

;-----
HideCursor PROC USES ax cx
;
; Hide the text cursor by setting its top line
; value to an illegal value.
; Receives: nothing. Returns: nothing
;-----
     mov    ah,GET_CURSOR_SIZE
     int    10h
     or     ch,30h                ; set upper row to illegal value
     mov    ah,1                  ; set cursor size
     int    10h
     ret
HideCursor ENDP

```

```

;-----
ShowCursor PROC USES ax cx
;
; Show the text cursor by setting size to default.
; Receives: nothing. Returns: nothing
;-----
    mov     ah,GET_CURSOR_SIZE
    int     10h
    mov     ah,1                ; set cursor size
    mov     cx,0607h           ; default size
    int     10h
    ret
ShowCursor ENDP

;-----
HideMousePointer PROC USES ax
;
; Hides the mouse pointer.
; Receives: nothing. Returns: nothing
;-----
    mov     ax,HIDE_MOUSE_POINTER
    int     33h
    ret
HideMousePointer ENDP

;-----
ShowMousePointer PROC USES ax
;
; Makes the mouse pointer visible.
; Receives: nothing. Returns: nothing
;-----
    mov     ax,SHOW_MOUSE_POINTER ; make mouse cursor visible
    int     33h
    ret
ShowMousePointer ENDP

;-----
LeftButtonPress PROC
;
; Checks for the most recent left mouse button press
; and displays the mouse location.
; Receives: nothing. Returns: nothing
;-----
    pusha
    mov     ax,GET_BUTTON_PRESS_INFO
    mov     bx,0                ; specify the left button
    int     33h

; Exit proc if the coordinates have not changed.
    cmp     cx,xPress           ; same X coordinate?
    jne     L1                  ; no: continue
    cmp     dx,yPress           ; same Y coordinate?
    je      L2                  ; yes: exit

; Coordinates have changed, so save them.
L1:  mov     xPress,cx
     mov     yPress,dx

```

```

; Position the cursor, clear the old numbers.
    mov     dh,statusRow      ; screen row
    mov     dl,statusCol     ; screen column
    call    Gotoxy
    push   dx
    mov     dx,OFFSET blanks
    call    WriteString
    pop    dx

; Show coordinates where mouse button was pressed.
    call    Gotoxy
    mov     ax,xCoord
    call    WriteDec
    mov     dl,buttonPressCol
    call    Gotoxy
    mov     ax,yCoord
    call    WriteDec

L2:  popa
     ret
LeftButtonPress ENDP

;-----
SetMousePosition PROC
;
; Set the mouse's position on the screen.
; Receives: CX = X-coordinate
;           DX = Y-coordinate
; Returns:  nothing
;-----
     mov     ax,4
     int     33h
     ret
SetMousePosition ENDP

;-----
ShowMousePosition PROC
;
; Get and show the mouse coordinates at the
; bottom of the screen.
; Receives: nothing
; Returns:  nothing
;-----
     pusha
     call    GetMousePosition

; Exit proc if the coordinates have not changed.
     cmp     cx,xCoord        ; same X coordinate?
     jne    L1                ; no: continue
     cmp     dx,yCoord        ; same Y coordinate?
     je     L2                ; yes: exit

; Save the new X and Y coordinates.
L1:  mov     xCoord,cx
     mov     yCoord,dx

```

```

; Position the cursor, clear the old numbers.
mov     dh,statusRow      ; screen row
mov     dl,statusCol2    ; screen column
call    Gotoxy
push   dx
mov     dx,OFFSET blanks
call    WriteString
pop     dx

; Show the mouse coordinates.
call    Gotoxy
mov     ax,xCoord
call    WriteDec
mov     dl,coordCol      ; screen column
call    Gotoxy
mov     ax,yCoord
call    WriteDec

L2:     popa
        ret
ShowMousePosition ENDP
END     main

```

*Varying Behaviors* The program's behavior changes a bit depending on two factors: (1) which version of MS-Windows you're running and (2) whether you run it in a console window or full-screen mode. In Windows XP and beyond, for example, the console window defaults to 50 vertical text lines. When you run in full-screen mode, the mouse cursor is a solid block; its coordinates appear to change one pixel at a time, whereas the mouse cursor jumps from one character to the next only when you have moved horizontally by 8 pixels or vertically by 16 pixels. In console window mode, the mouse cursor is a pointer; its coordinates change 8 pixels at a time horizontally and 16 pixels at a time vertically.

### 16.6.3 Section Review

1. Which INT 33h function resets the mouse and gets the mouse status?
2. Write ASM statements that reset the mouse and get the mouse status.
3. Which INT 33h function shows and hides the mouse pointer?
4. Write ASM statements that hide the mouse pointer.
5. Which INT 33h function gets the mouse position and status?
6. Write ASM statements that get the mouse position and store it in the variables **mouseX** and **mouseY**.
7. Which INT 33h function sets the mouse position?
8. Write ASM statements that set the mouse pointer to X = 100 and Y = 400.
9. Which INT 33h function gets mouse button press information?
10. Write ASM statements that jump to label **Button1** when the left mouse button has been pressed.
11. Which INT 33h function gets mouse button release information?
12. Write ASM statements that get the mouse position at the point when the right button was released, and store the position in the variables **mouseX** and **mouseY**.
13. Write ASM statements that set the vertical limits of the mouse to 200 and 400.
14. Write ASM statements that set the horizontal limits of the mouse to 300 and 600.



15. *Challenge:* Suppose you want the mouse pointer to point to the upper left corner of the character cell located at row 10, column 20 in text mode. What X and Y values will you have to pass to INT 33h Function 4, assuming 8 horizontal pixels per character and 16 vertical pixels per character?
16. *Challenge:* Suppose you want the mouse pointer to point to the middle of the character cell located at row 15, column 22 in text mode. What X and Y values will you have to pass to INT 33h Function 4, assuming 8 horizontal pixels per character and 16 vertical pixels per character?
17. *Challenge:* Who invented the computer mouse, in what year, and at what location?

## 16.7 Chapter Summary

Working at the BIOS level gives you more control over the computer's input-output devices than you would have at the MS-DOS level. This chapter shows how to program the keyboard using INT 16h, the video display using INT 10h, and the mouse, using INT 33h.

INT 16h is particularly useful for reading extended keyboard keys such as function keys and cursor arrow keys.

Keyboard hardware works with the INT 9h, INT 16h, and INT 21h handlers to make keyboard input available to programs. The chapter contains a program that polls the keyboard and breaks out of a loop when the Esc key is pressed.

Colors are produced on the video display using additive synthesis of primary colors. The color bits are mapped to the video attribute byte.

A wide range of useful INT 10h functions can control the video display at the BIOS level. The chapter contains an example program that scrolls a color window and writes text in the middle of it.

You can draw color graphics using INT 10h. The chapter contains two example programs that show how to do this. A simple formula can be used to convert Cartesian coordinates to screen coordinates (pixel locations).

An example program with documentation shows how to draw high-speed color graphics by writing directly to video memory.

Numerous INT 33h functions manipulate and read the mouse. An example program tracks both mouse movements and mouse button clicks.

*For More Information* Digging up information on BIOS functions is not easy because many of the good reference books have gone out of print. Here are my favorites:

- Ralf, Brown, and Jim Kyle, *PC Interrupts. A Programmer's Reference to BIOS, DOS, and Third-Party Calls*, Addison-Wesley, 1991.
- Ray, Duncan. *IBM ROM BIOS*, Microsoft Press, 1998.
- Ray, Duncan. *Advanced MS-DOS Programming*, 2nd ed., Microsoft Press, 1988.
- Frank van, Gilluwe. *The Undocumented PC: A Programmer's Guide to I/O, CPUs, and Fixed Memory Areas*, Addison-Wesley, 1996.
- Thom, Hogan. *Programmer's PC Sourcebook: Reference Tables for IBM PCs and Compatibles, Ps/2 Systems, Eisa-Based Systems, Ms-DOS Operating System Through Version*, Microsoft Press, 1991.
- Jim, Kyle. *DOS 6 Developer's Guide*, SAMS, 1993.
- Muhammad Ali, Mazidi, and Janice Gillispie Mazidi, *The 80x86 IBM PC & Compatible Computers*, 4th Ed., Volumes. I and II, Prentice-Hall, 2002.

This book's web site ([www.asmirvine.com](http://www.asmirvine.com)) has links to many additional sources of information, including Ralf Brown's current list of MS-DOS and BIOS interrupts.

## 16.8 Programming Exercises

The following exercises must be done in real-address mode:

### ★★ 1. ASCII Table

Using INT 10h, display all 256 characters from the IBM Extended ASCII character set (inside back cover of the book). Display 32 columns per line, with a space following each character.

### ★★★ 2. Scrolling Text Window

Define a text window that is approximately three fourths of the size of the video display. Let the program carry out the following actions, in sequence:

- Draw a string of random characters on the top line of the window. (You can call `Random_range` from the Irvine16 library.)
- Scroll the window down one line.
- Pause the program for approximately 200 milliseconds. (You can call the **Delay** function from the Irvine16 library.)
- Draw another line of random text.
- Continue scrolling and drawing until 50 lines have been displayed.

This program and its various enhancements were given a nickname by my assembly language students based on a popular movie in which characters interact in a virtual world. (I can't mention the name of the movie here, but you will probably figure it out by the time you complete the program.)

### ★★★ 3. Scrolling Color Columns

Using the **Scrolling Text Window** exercise as a starting point, make the following changes:

- The random string should only have characters in columns 0, 3, 6, 9, . . . , 78. The other columns should be blank. This will create the effect of columns as it scrolls downward.
- Each column should be in a different color.

### ★★★★ 4. Scrolling Columns in Different Directions

Using the **Scrolling Text Window** exercise as a starting point, make the following change: Before the loop starts, randomly choose each column to scroll either up or down. It should continue in the same direction for the duration of the program. *Hint:* Define each column as a separately scrolling window.

### ★ 5. Drawing a Rectangle Using INT 10h

Using the pixel-drawing capabilities of INT 10h, create a procedure named **DrawRectangle** that takes input parameters specifying the location of the upper left corner and the lower right corner, and the color. Write a short test program that draws several rectangles of different sizes and colors.

### ★★★ 6. Plotting a Function Using INT 10h

Using the pixel-drawing capabilities of INT 10h, plot the line determined by the equation  $Y = 2(X^2)$ .

### ★★★ 7. Mode 13 Line

Modify the Memory-Mapped Graphics program in Section 16.5.2 so that it draws a single vertical line.

### ★★★ 8. Mode 13, Multiple Lines

Modify the Memory-Mapped Graphics program in Section 16.5.2 so that it draws a series of 10 vertical lines, each in a different color.

**★★★ 9. Box-Drawing Program**

MS-DOS applications in the 1980s and early 1990s usually displayed boxes and frames using line-drawing characters in text mode. This programming exercise will reproduce those techniques. Write a procedure that draws a single-line frame anywhere on the screen. Use the following extended ASCII codes from the table on the inside back cover of this book: C0h, BFh, B3h, C4h, D9h, and DAh. The procedure's only input parameter should be a pointer to a FRAME structure:

```
FRAME STRUCT
    Left BYTE ?           ; left side
    Top  BYTE ?           ; top line
    Right BYTE ?          ; right side
    Bottom BYTE ?         ; bottom line
    FrameColor BYTE ?     ; box color
FRAME ENDS
```

Write a program that tests your procedure, passing it pointers to various FRAME objects.

**End Notes**

1. A prime example is Michael Abrash, *The Zen of Code Optimization*, Coriolis Group Books, 1994.
2. You may have trouble running *Pixel1.asm* and *Pixel2.asm* under MS-Windows on computers having a relatively low amount of video RAM. If this is a problem, switch to another mode or boot into pure MS-DOS mode.

---

# EXPERT MS-DOS PROGRAMMING

- 17.1 Introduction
- 17.2 Defining Segments
  - 17.2.1 Simplified Segment Directives
  - 17.2.2 Explicit Segment Definitions
  - 17.2.3 Segment Overrides
  - 17.2.4 Combining Segments
  - 17.2.5 Section Review
- 17.3 Runtime Program Structure
  - 17.3.1 Program Segment Prefix
  - 17.3.2 COM Programs
  - 17.3.3 EXE Programs
  - 17.3.4 Section Review
- 17.4 Interrupt Handling
  - 17.4.1 Hardware Interrupts
  - 17.4.2 Interrupt Control Instructions
  - 17.4.3 Writing a Custom Interrupt Handler
  - 17.4.4 Terminate and Stay Resident Programs
  - 17.4.5 Application: The No\_Reset Program
  - 17.4.6 Section Review
- 17.5 Hardware Control Using I/O Ports
  - 17.5.1 Input-Output Ports
  - 17.5.2 PC Sound Program
- 17.6 Chapter Summary

We recommend that you install an early version of Windows such as Windows 95 or Windows 98 to insure full compatibility with the programs in this chapter. You may want to use a software utility to create a virtual machine on your computer, so you can experiment with this software.

## 17.1 Introduction

This is a good chapter to read if you're planning to be an engineer who works at the hardware level on Intel processors. It's also a good chapter if you want to understand the amazing things MS-DOS experts were able to do with very limited resources a few years ago. It will give you some useful background if you plan to become a systems-level programmer. It is a chapter on MS-DOS system resources and programming. Here's what we're going to do:

- Show you how to get as much flexibility as possible from the .MODEL, .CODE, .STACK, and related directives.
- Show you how to define segments from scratch, using explicit segment directives.

- Demonstrate a large memory model program that has multiple code and data segments.
- Explain the runtime structure of COM and EXE programs, including EXE headers.
- Map out the Program Segment Prefix (PSP) and show how you can find the MS-DOS environment string.
- Show you how to replace existing interrupt handlers with your own. We will demonstrate this by writing a Ctrl-Break interrupt handler (also called an *interrupt service routine*, or ISR).
- Explain how hardware interrupts work and list the various *interrupt request* (IRQ) levels used by the Intel 8259 Programmable Interrupt Controller (PIC).
- Write a *terminate and stay resident* (TSR) program that intercepts the Ctrl-Alt-Del key combination. If you learn to do this, you can join the ranks of MS-DOS experts.
- Show how to write hardware data directly to output ports and how to use ports to monitor the status of hardware, control the behavior of hardware, and read input data from hardware devices.

If you've been around experienced programmers for a few years, you've probably heard a lot of the terms from the foregoing list. Notice how the old-time experts seem to drop terms like IRQ, TSR, PSP, and 8259 into their conversations? Now you can find out what they've been talking about.

## 17.2 Defining Segments

Programs written for the early versions of MASM had to create rather elaborate definitions for code, data, and stack segments. Instructors all breathed a sigh of relief when simplified segment directives (`.code`, `.stack`, `.data`) came along because they made the first week of class go much more smoothly. It was also clear, however, that expert programmers would probably prefer flexibility over simplicity and would stick with the traditional way of doing things. If you've reached this chapter (and understood all preceding chapters), you are now ready to master the arcane details of explicit segment directives.

First, however, we're going to explore the various ways the simplified directives can be used, just in case they satisfy your needs.

### 17.2.1 Simplified Segment Directives

When you use the `.MODEL` directive, the assembler automatically defines `DGROUP` for your near data segment. The segments in `DGROUP` form near data, which can normally be accessed directly through `DS` or `SS`.

The `.DATA` and `.DATA?` directives both create a near data segment, which can be as large as 64Kb when running in real-address mode. It is placed in a special group identified as `DGROUP`, which is also limited to 64Kb. When `.FARDATA` and `.FARDATA?` are used in the small and medium memory models, the assembler creates far data segments named `FAR_DATA` and `FAR_BSS`, respectively.

*Identifying a Variable's Segment* Some BIOS and DOS functions require you to use a particular segment register when passing argument data. You can assign a segment's address to a segment register using the `SEG` operator. The following, for example, sets `DS` to the segment containing **farvar**:

```
mov ax,SEG farvar
mov ds,ax
```

*Code Segments* Code segments are defined, as you know, by the `.CODE` directive. In a small memory model program, the `.CODE` directive causes the assembler to generate a segment named `_TEXT`. You can see this in the Segments and Groups section of a listing file:

```
_TEXT . . . .16 Bit 0009          Word Public 'CODE'
```

(This entry indicates that a 16-bit segment named `_TEXT` is 9 bytes long. It is aligned on an even word boundary, it is a public segment, and its segment class is 'CODE'.)

In medium, large, and huge model programs, each source code module is assigned a different segment name. The name consists of the module name followed by `_TEXT`. For example, in a program named *MyProg.asm* that uses the `.MODEL, LARGE` directive, the listing file generates the following code segment entry:

```
MYPROG_TEXT . . . .16 Bit 0009 Word Public 'CODE'
```

You can also declare multiple code segments within the same module, regardless of the memory model. Do this by adding an optional segment name to the `.CODE` directive:

```
.code MyCode
```

Keep this in mind: If you call the book's 16-bit link library procedures, your code must be located inside a segment named `_TEXT`. The following excerpt, for example, would cause the linker to generate a *fixup overflow* message:

```
.code MyCode
    mov dx,offset msg
    call WriteString
```

**Multiple Code Segment Program** The following *MultiCode.asm* program contains two code segments. By not including the *Irvine16.inc* file, we can show you all the MASM directives being used in the program:

```
TITLE Multiple Code Segments      (MultCode.asm)

; This small model program contains multiple
; code segments.

.model small,stdcall
.stack 100h
WriteString PROTO

.data
msg1 db "First Message",0dh,0ah,0
msg2 db "Second Message",0dh,0ah,"$"

.code
main PROC
    mov ax,@data
    mov ds,ax

    mov dx,OFFSET msg1
    call WriteString          ; NEAR call
    call Display              ; FAR call
    .exit
main ENDP

.code OtherCode
Display PROC FAR
    mov ah,9
    mov dx,offset msg2
    int 21h
    ret
Display ENDP
END main
```

In the foregoing example, the `_TEXT` segment contains the **main** procedure, and the **OtherCode** segment contains the **Display** procedure. Notice that the **Display** procedure must have a FAR modifier to

tell the assembler to generate the type of call instruction that saves both the current segment and offset on the stack. For confirmation, we can see the names of the two code segments in the *MultiCode.lst* listing file:

```
OtherCode . . . .16 Bit 0008      Word   Public 'CODE'
_TEXT . . . .16 Bit 0014      Word   Public 'CODE'
```

## 17.2.2 Explicit Segment Definitions

There are a few occasions when you may prefer to create explicit segment definitions. You may want to define multiple data segments with extra memory buffers, for instance. Or, you may be linking your program to an object library that uses its own proprietary segment names. Finally, you may be writing a procedure to be called from a high-level language compiler that does not use Microsoft's segment names.

A program with explicit segment definitions has two tasks to perform: First, a segment register (DS, ES, or SS) must be set to the location of each segment before it may be used. Second, the assembler must be told how to calculate the offsets of labels within the correct segments.

The `SEGMENT` and `ENDS` directives define the beginning and end of a segment, respectively. A program may contain almost any number of segments, each with a unique name. Segments can also be grouped together (combined). The syntax is

```
name SEGMENT [align] [combine] ['class']
    statement-list
name ENDS
```

- *name* identifies the segment; it can be unique or it can be the name of an existing segment.
- *align* can be `BYTE`, `WORD`, `DWORD`, `PARA`, or `PAGE`.
- *combine* can be `PRIVATE`, `PUBLIC`, `STACK`, `COMMON`, `MEMORY`, or `AT address`.
- *class* is an identifier enclosed in single quotes that is used when identifying a particular type of segment such as `CODE` or `STACK`.

For example, here is how a segment called **ExtraData** could be defined:

```
ExtraData SEGMENT PARA PUBLIC 'DATA'
    var1 BYTE 1
    var2 WORD 2
ExtraData ENDS
```

### Align Type

When two or more segments are to be combined, their *align types* tell the linker how to align their starting addresses. The default is `PARA`, which indicates that the segment must begin on an even 16-byte boundary. Here are examples of 20-bit hexadecimal addresses that fall on paragraph boundaries. Notice that the last digit is always zero:

```
0A150 81B30 07460
```

To create the specified alignment, the assembler inserts bytes at the end of any existing segment until the correct starting address for the new segment is reached. The extra bytes are called *slack bytes*. This only affects segments that are joined to an existing segment because the first segment in a group always begins on a paragraph boundary. (Recall from Chapter 2 that segment addresses always contain four implied low-order zero bits.) The following align types are available:

- The `BYTE` align type starts the segment on the next byte following the preceding segment.
- The `WORD` align type starts the segment at the next 16-bit boundary.
- `DWORD` starts the segment at the next 32-bit boundary.
- `PARA` starts the segment at the next 16-byte boundary.
- `PAGE` starts the segment at the next 256-byte boundary.

If a program will likely be run on an 8086 or 80286 processor, a WORD align type (or larger) is best for data segments because the processors have a 16-bit data bus. Such processors always move 2 bytes, the first of which has an even-numbered address. Therefore, a variable on an even boundary requires one memory fetch, whereas a variable on an odd boundary requires two. An x86 processor, on the other hand, fetches 32 bits at a time, and should use the DWORD align type.

### Combine Type

A segment's *combine type* tells the linker how to combine segments having the same name. The default type is PRIVATE, indicating that such a segment will not be combined with any other segment.

The PUBLIC and MEMORY combine types cause a segment to be combined with all other public or memory segments by the same name; in effect, they become a single segment. The offsets of all labels are adjusted so they are relative to the start of the same segment.

The STACK combine type resembles the PUBLIC type, in that all other stack segments will be combined with it. MS-DOS automatically initializes SS to the start of the first segment that it finds with a combine type of STACK; MS-DOS sets SP to the segment's length (minus 1) when the program is loaded. In an EXE program, there should be at least one segment with a STACK combine type; otherwise, the linker displays a warning message.

The COMMON combine type makes a segment begin at the same address as any other COMMON segments with the same name. In effect, the segments overlay each other. All offsets are calculated from the same starting address, and variables can overlap.

The AT *address* combine type lets you create a segment at an absolute address; it is often used for data whose location is predefined by the hardware or operating system. No variables or data may be initialized, but you can create variable names that refer to specific offsets. For example,

```

bios SEGMENT AT 40h
  ORG 17h
  keyboard_flag BYTE ?           ; MS-DOS keyboard flag
bios ENDS

.code
  mov  ax,bios                   ; point to BIOS segment
  mov  ds,ax
  and  ds:keyboard_flag,7Fh     ; clear high bit

```

In this example, a segment override (DS:) was required because **keyboard\_flag** is not in the standard data segment. We will explain segment overrides in Section 17.2.3.

### Class Type

A segment's *class type* provides another way of combining segments, in particular, those with different names. The class type is a case-sensitive string enclosed in single quotes. Segments with the same class type are loaded together, though they may be in a different order in the original program. One standard type, CODE, is recognized by the linker and should be used for segments containing instructions. You must include this type of label if you plan to use a debugger.

### ASSUME Directive

The ASSUME directive tells the assembler how to calculate offsets of code and data labels at assembly time. It is usually placed directly after the SEGMENT directive in the code segment. Its syntax requires the name of a segment register, followed by a colon, followed by the name of a segment:

```
ASSUME segreg : segname
```



ASSUME does not actually change the value of a segment register. That must be done at run time, using instructions that assign segment values to segment registers. Your code may contain multiple ASSUME directives. When a new one is encountered, the assembler modifies the way it calculates addresses from that point on.

The following ASSUME tells the assembler to use DS as the default register for the **data1** segment:

```
ASSUME ds:data1
```

The following statement associates CS with **myCode** and SS is associated with **myStack**:

```
ASSUME cs:myCode, ss:myStack
```

### **Example: Multiple Data Segments**

Earlier in this section we showed a program having two code segments. Let's now create a program (*MultData.asm*) containing two data segments named **data1** and **data2**. Both are declared with class name DATA. The ASSUME directive associates DS with **data1** and ES with **data2**:

```
ASSUME cs:cseg, ds:data1, es:data2, ss:mystack
data1 SEGMENT 'DATA'
data2 SEGMENT 'DATA'
```

The following is a complete program listing:

```
TITLE Multiple Data Segments                (MultData.asm)
; This program shows how to explicitly declare
; multiple data segments.
cseg SEGMENT 'CODE'
    ASSUME cs:cseg, ds:data1, es:data2, ss:mystack
main PROC
    mov ax,data1                ; point DS to data1 segment
    mov ds,ax
    mov ax,SEG val2             ; point ES to data2 segment
    mov es,ax

    mov ax,val1                 ; data1 segment assumed
    mov bx,val2                 ; data2 segment assumed

    mov ax,4C00h                ; exit program
    int 21h
main ENDP
cseg ENDS

data1 SEGMENT 'DATA'
    val1 WORD 1001h
data1 ENDS

data2 SEGMENT 'DATA'
    val2 WORD 1002h
data2 ENDS

mystack SEGMENT para STACK 'STACK'
    BYTE 100h dup('S')
mystack ENDS
END main
```

Two ways of setting segment register values at run time were used. The first used a segment name (**data1**):

```
mov ax,data1                ; point DS to data1 segment
mov ds,ax
```

The second method was to use the SEG operator to obtain the segment address of **val2**:

```
mov ax,SEG val2          ; point ES to data2 segment
mov es,ax
```

The listing file created by the assembler shows two variables **val1** and **val2** having the same values (starting offsets) but different segment attributes:

| Name           | Type | Value | Attr  |
|----------------|------|-------|-------|
| val1 . . . . . | Word | 0000  | data1 |
| val2 . . . . . | Word | 0000  | data2 |

### 17.2.3 Segment Overrides

A *segment override* is a one-byte prefix that makes the current instruction use a different segment register from the one specified by the ASSUME directive when calculating the effective address. It can be used, for example, to access a variable in a segment other than the one currently associated with CS or DS:

```
mov al,cs:var1          ; segment pointed to by CS
mov al,es:var2          ; segment pointed to by ES
```

It should be noted here that in real-address mode, you can place variables in the code segment. You could never get away with that in protected mode!

The following instruction obtains the offset of a variable in a segment not currently ASSUME'd by DS or ES:

```
mov bx,OFFSET AltSeg:var2
```

Multiple references to variables can be more easily handled by inserting an ASSUME to temporarily change the default segment references:

```
ASSUME ds:AltSeg        ; use AltSeg for a while
mov ax,AltSeg
mov ds,ax
mov al,var1
.
.
ASSUME ds:data          ; use the default data segment
mov ax,data
mov ds,ax
```

### 17.2.4 Combining Segments

Large programs should be divided into separate modules to simplify editing and debugging. Even source code located in different modules can be combined into the same segment. Just use the same segment name in each module and specify a PUBLIC combine type. That's exactly what happens when you link a 16-bit program with the book's Irvine16 link library, using simplified segment directives.

If you use a BYTE align type, each segment immediately follows the preceding one. If a WORD align type is used, a segment will follow another segment at the next even word boundary. The align type defaults to PARA, in which each segment follows at the next paragraph boundary.

*Program Example* Let's look at a two-module program containing one code segment (CSEG), one data segment (DSEG), and one stack segment (SSEG). The main module contains all three segments; CSEG and DSEG have a PUBLIC combine type. A BYTE align type is used for CSEG to avoid creating a gap between code from the two modules.

*Main Module:* TITLE Segment Example (main module, Seg2.asm)

```

EXTRN var2:WORD, subroutine_1:PROC
cseg SEGMENT BYTE PUBLIC 'CODE'
ASSUME cs:cseg,ds:dseg, ss:sseg

main PROC
    mov ax,dseg                ; initialize DS
    mov ds,ax

    mov ax,var1                ; local variable
    mov bx,var2                ; external variable
    call subroutine_1          ; external procedure

    mov ax,4C00h               ; exit to OS
    int 21h
main ENDP
cseg ENDS

dseg SEGMENT WORD PUBLIC 'DATA' ; local data segment
    var1 WORD 1000h
dseg ends

sseg SEGMENT STACK 'STACK'     ; stack segment
    BYTE 100h dup('S')
sseg ENDS
END main

```

*Submodule:* TITLE Segment Example (submodule, Seg2a.ASM)

```

PUBLIC subroutine_1, var2
cseg SEGMENT BYTE PUBLIC 'CODE'
ASSUME cs:cseg, ds:dseg

subroutine_1 PROC                ; called from MAIN
    mov ah,9
    mov dx,OFFSET msg
    int 21h
    ret
subroutine_1 ENDP
cseg ENDS

dseg SEGMENT WORD PUBLIC 'DATA'
var2 WORD 2000h                  ; accessed by MAIN
msg BYTE 'Now in Subroutine_1'
    BYTE 0Dh,0Ah,'$'
dseg ENDS
END

```

Linkers have the option of creating a MAP file, which lists all segments in the program. The following MAP file for this program shows one code segment, one data segment, and one stack segment:

| Start  | Stop   | Length | Name | Class |
|--------|--------|--------|------|-------|
| 00000H | 0001BH | 0001CH | CSEG | CODE  |
| 0001CH | 00035H | 0001AH | DSEG | DATA  |
| 00040H | 0013FH | 00100H | SSEG | STACK |

Program entry point at 0000:0000

### 17.2.5 Section Review

1. What is the purpose of the SEGMENT and ENDS directives?
2. What value does the SEG operator return?
3. Explain the function of the ASSUME directive.
4. In a segment definition, what are the possible align types?
5. In a segment definition, what are the possible combine types?
6. Which *align type* is most efficient for an x86 processor?
7. What is the purpose of the combine type in a segment definition?
8. How do you define a segment at an absolute address such as 40h?
9. What is the purpose of the class type option in a segment definition?
10. Write an instruction that uses a segment override.
11. In the following example, assume that **segA** begins at address 1A060h. What will be the starting address of the *third* segment, also called **segA**?

```
segA SEGMENT COMMON
    var1 WORD ?
    var2 BYTE ?
segA ends

stack SEGMENT STACK
    BYTE 100h dup(0)
stack ends

segA SEGMENT COMMON
    var3 WORD 3000h
    var4 BYTE 40h
segA ends
```

## 17.3 Runtime Program Structure

An effective assembly language programmer needs to know a lot about MS-DOS. This section describes *command.com*, the Program Segment Prefix, and the structure of COM and EXE programs. The *command.com* program supplied with MS-DOS and Windows 95 and 98 is called the command processor. From Windows 2000 onward, it is named *cmd.exe*. It interprets each command typed at a prompt. The following sequence takes place when you type a command:

1. MS-DOS checks to see if the command is internal, such as DIR, REN, or DEL (delete). If it is, the command is immediately executed by a memory-resident MS-DOS routine.
2. MS-DOS looks for a matching file with an extension of COM. If the file is in the current directory, it is executed.
3. MS-DOS looks for a matching file with an extension of EXE. If the file is in the current directory, it is executed.
4. MS-DOS looks for a matching file with an extension of BAT. If the file is in the current directory, it is executed. A file with an extension of BAT is called a batch file, which is a text file containing MS-DOS commands to be executed as if the commands had been typed at the console.
5. If MS-DOS is unable to find a matching COM, EXE, or BAT file in the current directory, it searches the first directory in the current path. If it fails to find a match there, it proceeds to the next directory in the path, and continues this process until either a matching file is found or the path search is exhausted.



program code to offset 100h. This leaves 100h bytes available for the PSP, which occupies locations 0 through 0FFh:

```
TITLE Hello Program in COM format    (HelloCom.asm)
.model tiny
.code
org 100h                               ; must be before main
main PROC
    mov     ah,9
    mov     dx,OFFSET hello_message
    int     21h
    mov     ax,4C00h
    int     21h
main ENDP

hello_message BYTE 'Hello, world!',0dh,0ah,'$'
END main
```

Variables are usually located after the main procedure because there is no separate segment for data. If we put the data at the top of the program, the CPU would try to execute the data. An alternative is to place a JMP instruction at the beginning that jumps over the data to the first actual instruction:

```
TITLE Hello Program in COM format    (HelloCom.asm)
.model tiny
.code
org 100h                               ; must be before entry point
main proc
    jmp     start                       ; skip over the data
hello_message BYTE 'Hello, world!',0dh,0ah,'$'

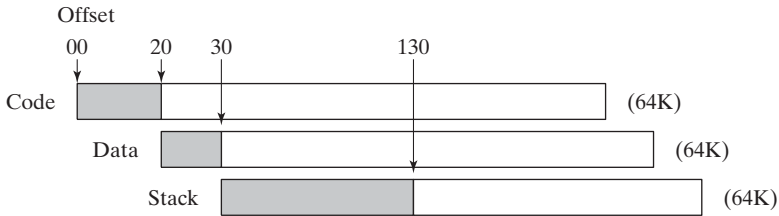
start:
    mov     ah,9
    mov     dx,OFFSET hello_message
    int     21h
    mov     ax,4C00h
    int     21h
main ENDP
END main
```

The Microsoft linker requires the /T parameter to tell it to create a COM file rather than an EXE file. COM programs are always smaller than their EXE counterparts—HelloCom.asm, for example, is only 17 bytes long when stored on disk. When in memory, however, a COM program eats up an entire 64K memory segment, whether it needs the space or not. COM programs were not designed to run in a multitasking environment.

### 17.3.3 EXE Programs

An EXE program is stored on disk with an EXE header followed by a load module containing the program itself. The program header is not actually loaded into memory; instead, it contains information used by MS-DOS to load and execute the program.

When MS-DOS loads an EXE program, a program segment prefix (PSP) is created at the first available address, and the program is placed in memory just above it. As MS-DOS decodes the program header, it sets DS and ES to the program's load address, also known as the *Program Segment Prefix* (PSP). CS and IP are set to the entry point of the program code, from where the program begins executing. SS is set to the beginning of the stack segment, and SP is set to the stack size. Here is a diagram showing overlapping code, data, and stack segments:



In this program, the code area is 20h bytes, the data area is 10h bytes, and the stack area is 100h bytes.

An EXE program may contain up to 65,535 segments, although it would be unusual to have that many. If a program has multiple data segments, the programmer usually has to manually set DS or ES to each new segment.

### Memory Usage

The amount of memory an EXE program uses is specified by its program header—in particular, the values for the minimum and maximum number of paragraphs (16 bytes each) needed in memory following the code area, to handle variables and the stack at run time. By default, the linker sets the maximum value to 65,535 paragraphs, which is more memory than could be available under MS-DOS. When the program is loaded, therefore, MS-DOS automatically allocates whatever memory is available.

The maximum allocation may be set when a program is linked, using the `/CP` option. This is shown here for a program named *prog1.obj*. The number 1024 refers to the number of 16-byte paragraphs, expressed in decimal:

```
link16 /cp:1024 prog1;
```

The EXE header values can be modified after an EXE program is compiled, using the `exehdr` program supplied with the Microsoft assembler. For example, the command to set the maximum allocation to 400h paragraphs (16,384 bytes) for a program named *prog1.exe* is

```
exehdr prog1 /max 400
```

`Exehdr` can display important statistics about a program. Sample output is shown here describing the *prog1.exe* program after it was linked with the maximum allocation set at 1024 paragraphs:

| PROG1                     | (Hex)     | (Dec) |
|---------------------------|-----------|-------|
| EXE size (bytes)          | 876       | 2166  |
| Minimum load size (bytes) | 786       | 1926  |
| Overlay number            | 0         | 0     |
| Initial CS:IP             | 0000:0010 | 16    |
| Initial SS:SP             | 0068:0100 | 256   |
| Minimum allocation (para) | 11        | 17    |
| Maximum allocation (para) | 400       | 1024  |
| Header size (para)        | 20        | 32    |
| Relocation table offset   | 1E        | 30    |
| Relocation entries        | 1         | 1     |

### EXE Header

The header area of an EXE program is used by MS-DOS to correctly calculate the addresses of segments and other components. The header contains information such as the following:

- A relocation table, containing addresses to be calculated when the program is loaded.
- The file size of the EXE program, measured in 512-byte units.
- Minimum allocation: the minimum number of memory paragraphs to reserve following the program code area. Some of this storage could be used for a runtime heap that holds dynamic data.

- Maximum allocation: the maximum number of paragraphs needed above the program.
- Starting values to be given to the IP and SP registers.
- *Displacement* (measured in 16-byte paragraphs) of the stack and code segments from the beginning of the load module.
- A *checksum* of all words in the file, used in catching data errors when loading the program into memory.

### 17.3.4 Section Review

1. When a command is typed at the MS-DOS prompt, what happens if the command is not an internal MS-DOS command?
2. Does MS-DOS look for BAT files before EXE files in the current directory when executing a command?
3. What are transient programs?
4. What is the name of the 256-byte area at the beginning of a transient program?
5. Where does a transient program keep the segment address of the current environment string?
6. What is a COM program?
7. Which memory model(s) are used by COM programs?
8. Which linker command-line switch is required when creating a COM program?
9. What is the memory limitation of a COM program?
10. When running, how efficient is a COM program's use of memory?
11. How many program segments can a COM program contain?
12. What are the starting values of all segment registers in a COM program?
13. What is the purpose of the ORG directive?
14. When stored on disk, the two main parts of an EXE program are the *header* and the \_\_\_\_\_ module.
15. Where do DS and ES point when an EXE program is loaded?
16. What determines the amount of memory allocated to an EXE program?
17. What is the purpose of the **exehdr** program?
18. If you wanted to know the number of relocation entries in an EXE file, where would you look?

## 17.4 Interrupt Handling

In this section we discuss ways to customize the BIOS and MS-DOS by installing *interrupt handlers* (*interrupt service routines*). As we saw in earlier chapters, the BIOS and MS-DOS contain interrupt handlers that simplify input/output as well as basic system tasks. We saw many of these—the INT 10h routines for video manipulation, the INT 16h keyboard routines, the INT 21h MS-DOS services, and so on. But an equally important part of the operating system is its set of interrupt handlers that respond to hardware interrupts. MS-DOS allows you to replace any of these service routines with one of your own.

**Limitations:** The interrupt handlers presented in this chapter work only when your computer is booted to MS-DOS mode. You can do this using Windows 95 and 98, but not in any of the more recent versions of Windows. The latter operating systems mask the system hardware from application programs to achieve greater system stability and security. If the OS were to allow two simultaneously running programs to modify internal settings on the same hardware device, the results would be unpredictable at best.

An interrupt handler might be written for a variety of reasons. You might want your program to activate when a *hot* key is pressed, even when the user is running another application. Borland's



SideKick, for example, was one of the first programs that was able to pop up a notepad or calculator whenever a special combination of hot keys was pressed.

You can replace one of MS-DOS's default interrupt handlers in order to provide more complete services. For example, the *divide by zero* interrupt activates when the CPU tries to divide a number by zero, but there is no standard way for a program to recover.

You can replace the MS-DOS critical error handler or the Ctrl-Break handler with one of your own. MS-DOS's default critical error handler causes a program to abort and return to MS-DOS. Your own handler could recover from an error and let the user continue to run the current application program.

A user-written interrupt service routine can handle hardware interrupts more effectively than MS-DOS. For example, the PC's asynchronous communication handler (INT 14h) performs no input/output buffering. This means that an input character is lost if it is not copied from the port before another character arrives. A memory-resident program can wait for an incoming character to generate a hardware interrupt, input the character from the port, and store it in a circular buffer. This frees an application program from having to take valuable time away from other tasks to repeatedly check the serial port.

**Interrupt Vector Table** The key to MS-DOS's flexibility lies in the interrupt vector table located in the first 1024 bytes of RAM (locations 0:0 through 0:03FF). Table 17-2 contains a short sample of vector table entries. Each entry in the table (called an interrupt vector) is a 32-bit segment-offset address that points to one of the existing service routines.

TABLE 17-2 Interrupt Vector Table Example.

| Interrupt Number | Offset | Interrupt Vectors                       |
|------------------|--------|-----------------------------------------|
| 00-03            | 0000   | 02C1:5186 0070:0C67 0DAD:2C1B 0070:0C67 |
| 04-07            | 0010   | 0070:0C67 F000:FF54 F000:837B F000:837B |
| 08-0B            | 0020   | 0D70:022C 0DAD:2BAD 0070:0325 0070:039F |
| 0C-0F            | 0030   | 0070:0419 0070:0493 0070:050D 0070:0C67 |
| 10-13            | 0040   | C000:0CD7 F000:F84D F000:F841 0070:237D |

On any given computer, the vector values will vary because of different versions of the BIOS and MS-DOS. Each interrupt vector corresponds to an interrupt number. In the table, the address of the INT 0 handler (divide by zero) is 02C1:5186h. The offset of any interrupt vector may be found by multiplying its interrupt number by 4. Thus, the offset of the vector for INT 9h is  $9 * 4$ , or 0024 hexadecimal.

**Executing Interrupt Handlers** An interrupt handler may be executed in one of two ways: (1) An application program containing an INT instruction could cause a call to the routine, which is called a *software interrupt*; (2) a *hardware interrupt* occurs when a hardware device (asynchronous port, keyboard, timer, and so on) sends a signal to the Programmable Interrupt Controller chip.

### 17.4.1 Hardware Interrupts

A hardware interrupt is generated by the Intel 8259 *Programmable Interrupt Controller* (PIC), which signals the CPU to suspend execution of the current program and execute an interrupt service routine. For example, a keyboard character waiting at the input port would be lost if not saved by the CPU, or characters received from the serial port would be lost if not for an interrupt-driven routine that stores them in a buffer.

Occasionally, programs must disable hardware interrupts when performing sensitive operations on segment registers and the stack. The CLI (*clear interrupt flag*) instruction disables interrupts, and the STI (*set interrupt flag*) instruction enables interrupts.

**IRQ Levels** Interrupts can be triggered by a number of different devices on a PC, including those listed in Table 17-3. Each device has a priority, based on its *interrupt request level* (IRQ). Level 0 has the highest priority, and level 15 has the lowest. A lower-level interrupt cannot interrupt a higher-level one still in progress. For instance, if communications port 1 (COM1) tried to interrupt the keyboard interrupt handler, it would have to wait until the latter was finished. Also, two or more simultaneous interrupt requests are processed according to their priority levels. The scheduling of interrupts is handled by the 8259 PIC.

Let's use the keyboard as an example: When a key is pressed, the 8259 PIC sends an INTR signal to the CPU, passing it the interrupt number; if external interrupts are not currently disabled, the CPU does the following, in sequence:

1. Pushes the Flags register on the stack.
2. Clears the Interrupt flag, preventing any other hardware interrupts.
3. Pushes the current CS and IP on the stack.
4. Locates the interrupt vector table entry for INT 9 and places this address in CS and IP.

TABLE 17-3 IRQ Assignments (ISA Bus).

| IRQ | Interrupt Number | Description                       |
|-----|------------------|-----------------------------------|
| 0   | 8                | System timer (18.2 times/second)  |
| 1   | 9                | Keyboard                          |
| 2   | 0Ah              | Programmable Interrupt Controller |
| 3   | 0Bh              | COM2 (serial port 2)              |
| 4   | 0Ch              | COM1 (serial port 1)              |
| 5   | 0Dh              | LPT2 (parallel port 2)            |
| 6   | 0Eh              | Floppy disk controller            |
| 7   | 0Fh              | LPT1 (parallel port 1)            |
| 8   | 70h              | CMOS real-time clock              |
| 9   | 71h              | (Redirected to INT 0Ah)           |
| 10  | 72h              | (Available) sound card            |
| 11  | 73h              | (Available) SCSI card             |
| 12  | 74h              | PS/2 mouse                        |
| 13  | 75h              | Math coprocessor                  |
| 14  | 76h              | Hard disk controller              |
| 15  | 77h              | (Available)                       |

Next, the BIOS routine for INT 9 executes, and it does the following in sequence:

1. Reenables hardware interrupts so the system timer is not affected.
2. Inputs a scan code from the keyboard port, attempts to convert it to an ASCII character, or assigns an ASCII code equal to zero. It then stores the scan code and ASCII code in the keyboard buffer, a 32-byte circular buffer in the BIOS data area.

3. Executes an IRET (interrupt return) instruction, which pops IP, CS, and the Flags register off the stack. Control returns to the program that was executing when the interrupt occurred.

### 17.4.2 Interrupt Control Instructions

The CPU has a flag called the *Interrupt flag* (IF) that controls the way the CPU responds to external (hardware) interrupts. If the Interrupt flag is set (IF = 1), we say that interrupts are *enabled*; if the flag is clear (IF = 0), then interrupts are *disabled*.

**STI Instruction** The STI instruction enables external interrupts. For example, the system responds to keyboard input by suspending a program in process and doing the following: It calls INT 9, which stores the keystroke in a buffer and then returns to the current program. Normally, the Interrupt flag is enabled. Otherwise, the system timer would not calculate the time and date properly, and input keystrokes would be lost.

**CLI Instruction** The CLI instruction disables external interrupts. It should be used sparingly—only when a critical operation is about to be performed, one that cannot be interrupted. Suppose, for example, your code was interrupted while in the process of changing the values of SS and SP. Your SS register might point to a new stack segment, whereas your stack pointer has yet to be updated:

```

mov   ax,mystack           ; reset SS
mov   ss,ax
; INTERRUPTED HERE!!!
mov   sp,100h             ; reset SP

```

To be on the safe side, disable interrupts by clearing the Interrupt flag (CLI), and enable interrupts using STI:

```

cli           ; disable interrupts
mov   ax,mystack   ; reset SS
mov   ss,ax
mov   sp,100h     ; reset SP
sti           ; reenale interrupts

```

Interrupts should not be disabled for more than a few milliseconds at a time, or you may lose keystrokes and slow down the system timer. When the CPU responds to an interrupt handler, other interrupts are immediately disabled. MS-DOS and BIOS interrupt service routines reenale interrupts as soon as they begin to execute.

### 17.4.3 Writing a Custom Interrupt Handler

One might ask why the interrupt vector table exists at all. We could, of course, call specific procedures in ROM to process interrupts. The designers of the IBM-PC wanted to be able to make modifications and corrections to the BIOS routines without having to replace the ROM chips. By having an interrupt vector table, it was possible to replace addresses in the interrupt vector table so they would point to procedures in RAM.

Each address in the interrupt vector table points to a procedure called an *interrupt handler* or *interrupt service routine* (ISR). Application programs can replace an address in the table with a new one that points to a new interrupt handler. For example, one could write a custom keyboard interrupt handler. There would have to be a compelling reason to do so because of the effort involved. A more likely alternative would be for an interrupt handler to directly call the default INT 9 keyboard to read a keystroke from the keyboard port. Once the key was placed in the keyboard typeahead buffer, one could manipulate its contents.

INT 21h Functions 25h and 35h make it possible to install interrupt handlers. Function 35h (get interrupt vector) returns the segment-offset address of an interrupt vector. Call the function with the

desired interrupt number in AL. The 32-bit vector is returned by MS-DOS in ES:BX. The following statements would retrieve the INT 9 vector, for example:

```
.data
int9Save LABEL WORD
DWORD ? ; store old INT 9 address here

.code
mov ah,35h ; get interrupt vector
mov al,9 ; for INT 9
int 21h ; call MS-DOS
mov int9Save,BX ; store the offset
mov int9Save+2,ES ; store the segment
```

INT 21h Function 25h (set interrupt vector) lets you replace an existing interrupt handler with a new handler. Call it with the interrupt number in AL and the segment-offset address of your own interrupt handler in DS:DX. For example,

```
mov ax,SEG kybd_rtn ; keyboard handler
mov ds,ax ; segment
mov dx,OFFSET kybd_rtn ; offset
mov ah,25h ; set Interrupt vector
mov al,9h ; for INT 9h
int 21h
:
:
kybd_rtn PROC ; (new INT 9 interrupt handler begins here)
```

### **Ctrl-Break Handler Example**

If Ctrl-Break is pressed by the user when an MS-DOS program is waiting for input, control passes to the default INT 23h interrupt handler procedure. The default Ctrl-Break handler terminates the currently running program. This can leave the current program in an unstable state because files might be left open, memory not released, and so on. It is possible, however, to substitute your own code into the INT 23h handler and prevent the program from halting. The following program installs a simple Ctrl-Break handler:

```
TITLE Control-Break Handler (Ctrlbrk.asm)
; This program installs its own Ctrl-Break handler and
; prevents the user from using Ctrl-Break (or Ctrl-C)
; to halt the program. The program inputs and echoes
; keystrokes until the Esc key is pressed.
INCLUDE Irvine16.inc

.data
breakMsg BYTE "BREAK",0
msg BYTE "Ctrl-Break demonstration."
BYTE 0dh,0ah
BYTE "This program disables Ctrl-Break (Ctrl-C). Press any"
BYTE 0dh,0ah
BYTE "keys to continue, or press ESC to end the program."
BYTE 0dh,0ah,0

.code
main PROC
mov ax,@data
mov ds,ax
```

```

        mov     dx,OFFSET msg           ; display greeting message
        call   WriteString

install_handler:
        push   ds                       ; save DS
        mov    ax,@code                 ; initialize DS to code segment
        mov    ds,ax
        mov    ah,25h                   ; set interrupt vector
        mov    al,23h                   ; for interrupt 23h
        mov    dx,OFFSET break_handler
        int    21h
        pop    ds                       ; restore DS

L1:     mov    ah,1                       ; wait for a key, echo it
        int    21h
        cmp    al,1Bh                   ; ESC pressed?
        jnz   L1                        ; no: continue

        exit
main    ENDP

; The following procedure executes when Ctrl-Break is
; pressed. All registers must be preserved.

break_handler PROC
        push   ax
        push   dx
        mov    dx,OFFSET breakMsg
        call   WriteString
        pop    dx
        pop    ax
        iret
break_handler ENDP
END main

```

The **main** procedure initializes the interrupt vector for INT 23h. The required input parameters for INT 21h function 25h are

- AH = 25h
- AL = interrupt vector to be handled (23h)
- DS:DX = segment/offset address of the new Ctrl-Break handler

The program's main loop simply inputs and echoes keystrokes until the Esc key is pressed.

On some systems, you may have to press Ctrl-C rather than Ctrl-Break to activate the Ctrl-Break handler message.

The **break\_handler** procedure executes when Ctrl-Break is pressed; it displays a message by calling WriteString and immediately returns to the calling program. When IRET (return from interrupt) executes at the end of break\_handler, control returns to the main program. Whichever MS-DOS function was in progress when Ctrl-Break was pressed is restarted. In general, you can call any MS-DOS interrupts from inside a Ctrl-Break handler. You must preserve all registers in an interrupt handler.

You do not have to restore the INT 23h vector because MS-DOS automatically does it when a program ends. The original vector is stored by MS-DOS at offset 000Eh in the program segment prefix.

### 17.4.4 Terminate and Stay Resident Programs

A *terminate and stay resident* (TSR) program is installed in memory and stays there until it is either removed by special removal utility software or the computer is rebooted. A TSR remains dormant until activated by some event such as pressing a key.

In the early days of TSRs, compatibility problems would arise when two or more programs replaced the same interrupt vector. Older programs would make the vector point to their own program and provide no forward chain to other programs using the same vector. Later, to remedy this problem, TSR authors would save the existing vector for the interrupt they were replacing, and forward-chain to the original interrupt handler after their own procedure was finished dealing with the interrupt. This, of course, was an improvement over the old method, but it meant that the last TSR to be installed automatically had top priority in handling the interrupt. It meant that users sometimes had to be careful to load TSR programs in a particular order. When MS-DOS applications were widespread, commercial programming tools existed to manage multiple memory-resident programs.

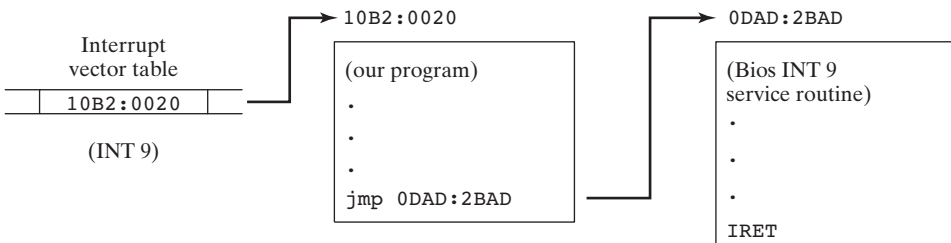
#### Keyboard Example

Suppose we write an interrupt service routine that can inspect each character typed at the keyboard and store it at location 10B2:0020. To install the ISR, we fetch the current INT 9 vector from the interrupt vector table, save it, and replace the table entry with the address of our ISR.

When a keyboard key is pressed, a single byte is transferred by the keyboard controller to the computer's keyboard port, and a hardware interrupt is triggered. The 8259 PIC passes the interrupt number to the CPU, and the latter jumps to the INT 9 address in the interrupt vector table, the address of our ISR. Our procedure gets an opportunity to inspect the keyboard byte. When our keyboard handler exits, it executes a jump to the original BIOS keyboard handler procedure.

This chaining process is shown in Fig. 17-1. The addresses are hypothetical. When the BIOS INT 9h routine finishes, the IRET instruction pops the Flags register from the stack and returns control to the program that was executing when the character was pressed.

FIGURE 17-1 Vectoring an interrupt.



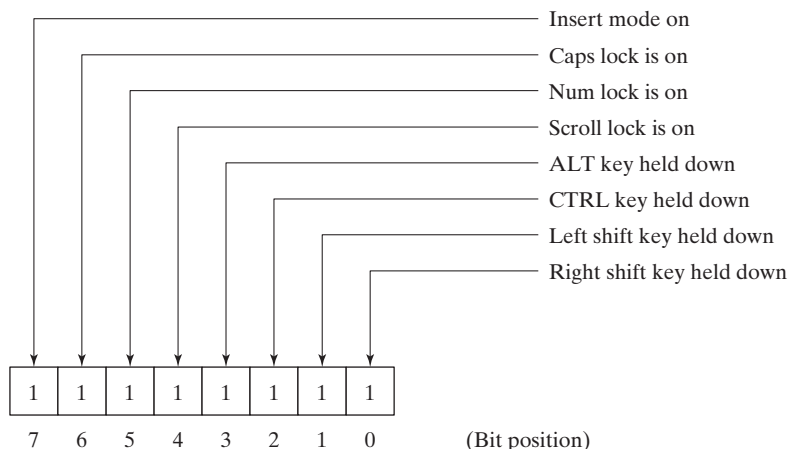
### 17.4.5 Application: The No\_Reset Program

A simple type of memory-resident program is one that prevents the system from being rebooted by the Ctrl-Alt-Delete keys. Once our program is installed in memory, the system may only be rebooted by pressing a special combination of keys: Ctrl-Alt-RightShift-Del. (The only other way to deactivate the program is to turn off and restart the computer.) This program only works if you boot the computer in MS-DOS. All recent versions of Microsoft Windows prevent a TSR program from intercepting keyboard keys.

*The MS-DOS Keyboard Status Byte* One bit of information we need before we start is the location of the keyboard status byte kept by MS-DOS in low memory, shown in Fig. 17-2. Our program will

inspect this flag to see if the Ctrl, Alt, Del, and RightShift keys are held down. The keyboard status flag is stored in RAM at location 0040:0017h. The label on the right side of the diagram shows what each bit means when it equals 1.

FIGURE 17-2 Keyboard status flag byte.



An additional keyboard status byte, located at 0040:0018, duplicates the preceding flags, except that bit 3 shows when Ctrl-NumLock is currently active.

**Installing the Program** The memory-resident code must be installed in memory before it will work. From that point on, all keyboard input is filtered through the program. If the routine has any bugs, the keyboard will probably lock up and require us to cold-start the machine. Keyboard interrupt handlers are particularly hard to debug because we use the keyboard constantly when debugging programs. Professionals who regularly write TSR programs usually invest in hardware-assisted debuggers that maintain a trace buffer in protected memory. Often the most elusive bugs appear only when a program is running in real time, not when you are single-stepping through it. *Note: You must boot the computer in MS-DOS mode before installing this program.*

**Program Listing** In the following program listing, the installation code is located at the end because it will not remain resident in memory. The resident portion, beginning with the label **int9\_handler**, is left in memory and pointed to by the INT 9h vector:

```
TITLE Reset-Disabling program                (No_Reset.asm)
; This program disables the usual DOS reset command
; (Ctrl+Alt+Del), by intercepting the INT 9 keyboard
; hardware interrupt. It checks the shift status bits
; in the MS-DOS keyboard flag and changes any Ctrl+Alt+Del
; to Alt+Del. The computer can only be rebooted by
; typing Ctrl+Alt+Right shift+Del. Assemble, link,
; and convert to a COM program by including the /T
; command on the Microsoft LINK command line.
; Boot into pure MS-DOS mode before running this program.

.model tiny
.386
.code
```

```

    rt_shift EQU 01h           ; Right shift key: bit 0
    ctrl_key EQU 04h           ; CTRL key: bit 2
    alt_key  EQU 08h           ; ALT key: bit 3
    del_key  EQU 53h           ; scan code for DEL key
    kybd_port EQU 60h          ; keyboard input port

    ORG 100h                   ; this is a COM program
start:
    jmp setup                   ; jump to TSR installation
; Memory-resident code begins here
int9_handler PROC FAR
    sti                         ; enable hardware interrupts
    pushf                       ; save regs & flags
    push es
    push ax
    push di

; Point ES:DI to the DOS keyboard flag byte:
L1: mov ax,40h                 ; DOS data segment is at 40h
    mov es,ax
    mov di,17h                 ; location of keyboard flag
    mov ah,es:[di]             ; copy keyboard flag into AH

; Test for the CTRL and ALT keys:
L2: test ah,ctrl_key           ; CTRL key held down?
    jz L5                       ; no: exit
    test ah,alt_key            ; ALT key held down?
    jz L5                       ; no: exit

; Test for the DEL and Right-shift keys:
L3: in al,kybd_port            ; read keyboard port
    cmp al,del_key             ; DEL key pressed?
    jne L5                     ; no: exit
    test ah,rt_shift           ; right shift key pressed?
    jnz L5                     ; yes: allow system reset

L4: and ah,NOT ctrl_key        ; no: turn off bit for CTRL
    mov es:[di],ah             ; store keyboard_flag

L5: pop di                     ; restore regs & flags
    pop ax
    pop es
    popf
    jmp cs:[old_interrupt9]    ; jump to INT 9 routine

old_interrupt9 DWORD ?

int9_handler ENDP
end_ISR label BYTE

; ----- (end of TSR program) -----
; Save a copy of the original INT 9 vector, and set up
; the address of our program as the new vector. Terminate
; this program and leave the int9_handler procedure in memory.
setup:
    mov ax,3509h                ; get INT 9 vector
    int 21h
    mov word ptr old_interrupt9,bx ; save INT 9 vector
    mov word ptr old_interrupt9+2,es

```



```

        mov     ax,2509h                ; set INT 9 vector
        mov     dx,offset int9_handler
        int     21h

        mov     ax,3100h                ; terminate and stay resident
        mov     dx,OFFSET end_ISR      ; point to end of resident code
        shr     dx,4                    ; divide by 16
        inc     dx                       ; round upward to next paragraph
        int     21h                     ; execute MS-DOS function
END start

```

First let's look at the instructions that install the program. At the label called **setup**, we call INT 21h Function 35h to get the current INT 9h vector, which is then stored in **old\_interrupt9**. This is done so the program will be able to forward-chain to the existing keyboard handler procedure. In the same part of the program, INT 21h Function 25h sets interrupt vector 9h to the address of the resident portion of this program. At the end of the program, the call to INT 21h Function 31h exits to MS-DOS, leaving the resident program in memory. The function automatically saves everything from the beginning of the PSP to the offset placed in DX.

*The Resident Program* The memory-resident interrupt handler begins at the label named **int9\_handler**. It is executed every time a keyboard key is pressed. We reenable interrupts as soon as the handler gets control because the 8259 PIC has automatically disabled interrupts:

```

int9_handler PROC far
    sti                ; enable hardware interrupts
    pushf             ; save registers and status flags
    (etc...)

```

Bear in mind that a keyboard interrupt often occurs while another program is executing. If we modified the registers or status flags here, we would cause unpredictable results in an application program.

The following statements locate the keyboard flag byte stored at address 0040:0017 and copy it into AH. The byte must be tested to see which keys are currently being held down:

```

L1:  mov     ax,40h                ; MS-DOS data segment is at 40h
     mov     es,ax
     mov     di,17h                ; location of keyboard flag
     mov     ah,es:[di]           ; copy keyboard flag into AH

```

The following statements check for both the Ctrl and Alt keys. If both are not currently held down, we exit:

```

L2:  test    ah,ctrl_key           ; CTRL key held down?
     jz     L5                     ; no: exit
     test   ah,alt_key            ; ALT key held down?
     jz     L5                     ; no: exit

```

If the Ctrl and Alt keys are both held down, someone may be trying to boot the computer. To find out which character was pressed, we input the character from the keyboard port and compare it to the Del key:

```

L3:  in     al,kybd_port           ; read keyboard port
     cmp    al,del_key            ; Del key pressed?
     jne    L5                     ; no: exit
     test   ah,rt_shift          ; Right-Shift key pressed?
     jnz   L5                     ; yes: allow system reset

```

If the user has not pressed the Del key, we simply exit and let INT 9h process the keystroke. If the Del key is held down, we know that Ctrl-Alt-Del was pressed; we only allow the system to be reset if the user is also holding down the Right Shift key. Otherwise, the Ctrl key bit in the keyboard flag byte is cleared, effectively disabling the user's attempt to reboot the computer:

```
L4:  and    ah,NOT ctrl_key      ; no: turn off bit for CTRL
      mov    es:[di],ah         ; store keyboard_flag
```

Finally, we execute a far jump to the existing BIOS INT 9h routine, stored in the variable **old\_interrupt9**. This allows all normal keystrokes to be processed, which is vital to the computer's basic operation:

```
jmp cs:[old_interrupt9]      ; jump to INT 9 routine
```

### 17.4.6 Section Review

1. What default action is carried out by the *critical error handler*?
2. What is contained in each entry of the interrupt vector table?
3. At which address is the interrupt vector for INT 10h stored?
4. Which controller chip generates hardware interrupts?
5. Which instruction disables hardware interrupts?
6. Which instruction enables hardware interrupts?
7. Which IRQ level has the highest priority, 0 or 15?
8. Based on what you know about IRQ levels, if a program is in the process of creating a disk file and you press a key on the keyboard, when do you think the key will be placed in the keyboard buffer—before or after the file has been created?
9. When a key is pressed on the keyboard, which hardware interrupt is executed?
10. When an interrupt handler finishes, how does the CPU resume execution wherever it was before the interrupt was triggered?
11. Which MS-DOS functions get and set interrupt vectors?
12. Explain the difference between an interrupt handler and a memory-resident program.
13. Describe a TSR program.
14. How can a TSR program be removed from memory?
15. If a memory-resident program replaces one of the interrupt vectors, how can it still take advantage of some functions in the interrupt's existing handler?
16. Which MS-DOS function terminates a program and leaves part of the program resident in memory?
17. In the No\_reset program, what key combination will actually boot the computer?

## 17.5 Hardware Control Using I/O Ports

x86 systems offer two types of hardware input–output: *memory-mapped* and *port-based*. When *memory-mapped I/O* is used, a program can write data to a particular memory address, and the data is transferred to the output device. Similarly, data can be read from an input device by copying data from a predefined memory address. The text video display is an example of a memory-mapped device. When you place characters in the video segment, they immediately appear on the display.

*Port-based I/O* requires the IN and OUT instructions to read and write data to specific numbered locations called *ports*. Ports are connections, or gateways, between the CPU and other devices, such as the keyboard, speaker, modem, and sound card.

### 17.5.1 Input–Output Ports

Each input–output port has a specific number between 0 and FFFFh. A port is used when controlling the speaker, for example, by rapidly toggling the speaker cone in and out. You can communicate directly with the asynchronous adapter through a serial port by setting the port parameters (baud rate, parity, and so on) and by sending data through the port.

The keyboard port is a good example of an input–output port. When a key is pressed, the keyboard controller chip sends an 8-bit scan code to port 60h. The keystroke triggers a hardware interrupt, which prompts the CPU to call INT 9 in the ROM BIOS. INT 9 inputs the scan code from the port, looks up the key’s ASCII code, and stores both values in the keyboard input buffer. In fact, it would be possible to bypass the operating system completely and read characters directly from port 60h.

In addition to ports that transfer data, most hardware devices have ports that let you monitor the device status and control the device behavior.

*IN and OUT Instructions* The IN instruction inputs a byte, word, or doubleword from a port. Conversely, the OUT instruction outputs a value to a port. The syntax for both instructions is

```
IN  accumulator,port
OUT port,accumulator
```

*Port* may be a constant in the range 0 to FFh, or it may be a value in DX between 0 and FFFFh. *Accumulator* must be AL for 8-bit transfers, AX for 16-bit transfers, and EAX for 32-bit transfers. Examples are as follows:

```
in  al,3Ch           ; input byte from port 3Ch
out 3Ch,al          ; output byte to port 3Ch
mov dx, portNumber ; DX can contain a port number
in  ax,dx           ; input word from port named in DX
out dx,ax           ; output word to the same port
in  eax,dx          ; input doubleword from port
out dx,eax          ; output doubleword to same port
```

### 17.5.2 PC Sound Program

We can write a program that uses the IN and OUT instructions to generate sound through the PC’s built-in speaker. The speaker control port (number 61h) turns the speaker on and off by manipulating the Intel 8255 *Programmable Peripheral Interface* chip. To turn the speaker on, input the current value in port 61h, set the lowest 2 bits, and output the byte back through the port. To turn off the speaker, clear bits 0 and 1 and output the status again.

Our sound program will not produce sound on a laptop computer if its speaker is directly connected to the sound card rather than the speaker port (61h).

The Intel 8253 Timer chip controls the frequency (pitch) of the sound being generated. To use it, we send a value between 0 and 255 to port 42h. The Speaker Demo program shows how to generate sound by playing a series of ascending notes:

```
TITLE Speaker Demo Program           (Spkr.asm)
; This program plays a series of ascending notes on
; an IBM-PC or compatible computer.

INCLUDE Irvine16.inc

speaker EQU 61h                       ; address of speaker port
timer   EQU 42h                       ; address of timer port
delay1  EQU 500
```

```

delay2 EQU 0D000h           ; delay between notes
.code
main PROC
    in    al,speaker        ; get speaker status
    push ax                 ; save status
    or    al,00000011b     ; set lowest 2 bits
    out   speaker,al       ; turn speaker on
    mov   al,60             ; starting pitch
L2: out   timer,al         ; timer port: pulses speaker
    ; Create a delay loop between pitches.

    mov   cx,delay1
L3: push  cx                 ; outer loop
    mov   cx,delay2
L3a:  loop  L3a              ; inner loop
    pop   cx
    loop  L3
    sub   al,1              ; raise pitch
    jnz   L2                ; play another note

    pop   ax                 ; get original status
    and   al,11111100b     ; clear lowest 2 bits
    out   speaker,al       ; turn speaker off
    exit
main ENDP
END main

```

First, the program turns the speaker on using port 61h by setting the lowest 2 bits in the speaker status byte:

```

    or    al,00000011b     ; set lowest 2 bits
    out   speaker,al       ; turn speaker on

```

Then it sets the pitch by sending 60 to the timer chip:

```

    mov   al,60            ; starting pitch
L2: out   timer,al         ; timer port: pulses speaker

```

A delay loop makes the program pause before changing the pitch again. The amount of delay will vary between computers because of differing processor speeds. You may have to adjust the values of **delay1** and **delay2**:

```

    mov   cx,delay1
L3: push  cx                 ; outer loop
    mov   cx,delay2
L3a:  loop  L3a              ; inner loop
    pop   cx
    loop  L3

```

After the delay, the program subtracts 1 from the period (1/frequency), which raises the pitch. The new frequency is output to the timer when the loop repeats. This process continues until the frequency counter in AL equals 0. Finally, the program pops the original status byte from the speaker port and turns the speaker off by clearing the lowest 2 bits:

```

    pop   ax                 ; get original status
    and   al,11111100b     ; clear lowest 2 bits
    out   speaker,al       ; turn speaker off

```

## 17.6 Chapter Summary

There are a few occasions when programmers need to create explicit segment definitions, particularly when adapting to existing code libraries that use their own segment names. The `SEGMENT` and `ENDS` directives define the beginning and end of a segment, respectively. When the segment being defined is combined with another segment, its *align type* tells the linker how many bytes to skip. The *combine type* tells the linker how to combine segments having the same name. A segment's class type provides yet another way of combining segments. Multiple segments may be combined by giving them the same name and specifying a `PUBLIC combine type`.

The `ASSUME` directive makes it possible for the assembler to calculate the offsets of labels and variables at assembly time. A segment override prefix instructs the processor to use a different segment register from the default segment for the current instruction.

The MS-DOS command processor interprets each command typed at a command prompt. Programs with extensions of `COM` and `EXE` are called *transient programs*. They are loaded into memory and executed, and then the memory they occupy is released. MS-DOS creates a special 256-byte block at the beginning of a transient program named the *Program Segment Prefix*.

There are two types of transient programs, identified by the extension used: `COM` and `EXE`. A `COM` program is an unmodified binary image of a machine-language program. An `EXE` program is stored on disk with an `EXE` header followed by a load module containing the program itself. The header area of an `EXE` program is used by MS-DOS to correctly calculate the addresses of segments and other components.

*Interrupt handlers* (interrupt service routines) simplify input/output as well as basic system tasks. You can also replace the default interrupt handlers with your own code to provide more complete or customized services. The interrupt vector table is located in the first 1024 bytes of RAM (locations 0:0 through 0:03FF). Each entry in the table is a 32-bit segment-offset address that points to an interrupt service routine.

A hardware interrupt is generated by the 8259 Programmable Interrupt Controller (PIC), which signals the CPU to suspend execution of the current program and execute an interrupt service routine. Hardware interrupts allow important events in the background to be noticed by the CPU before essential data are lost. Interrupts can be triggered by a number of different devices, each having a priority based on its *interrupt request level* (IRQ).

The Interrupt flag controls the way the CPU responds to external (hardware) interrupts. If the Interrupt flag is set, interrupts are enabled; if the flag is clear, interrupts are disabled. The `STI` (set interrupt) instruction enables interrupts; the `CLI` (clear interrupt) instruction disables interrupts.

A *terminate and stay resident* (TSR) program leaves part of itself in memory. The most common use for TSR programs is for installed interrupt handlers that remain in memory until the computer is rebooted or the TSR is removed by a special uninstaller.

The `No_reset` program presented in this chapter is a TSR program that prevents the system from being rebooted by the usual `Ctrl-Alt-Delete` keys.

x86 systems offer two types of hardware input–output: *memory-mapped* and *port-based*. When *memory-mapped I/O* is used, a program can write data to a particular memory address, and the data is transferred to the output device. *Port-based I/O* requires the `IN` and `OUT` instructions to read and write data to specific numbered locations called *ports*.

The speaker control port (number 61h) turns the speaker on and off by manipulating the Intel 8255 *Programmable Peripheral Interface* chip. The *Speaker Demo* program shows how to generate sound by playing a series of ascending notes.

---

# MASM REFERENCE

|     |                          |     |                   |
|-----|--------------------------|-----|-------------------|
| A.1 | Introduction             | A.5 | MASM Directives   |
| A.2 | MASM Reserved Words      | A.6 | Symbols           |
| A.3 | Register Names           | A.7 | Operators         |
| A.4 | Microsoft Assembler (ML) | A.8 | Runtime Operators |

## A.1 Introduction

The Microsoft MASM 6.11 manuals were last printed in 1992, and consisted of three volumes:

- Programmers Guide
- Reference
- Environment and Tools

Unfortunately, the printed manuals have not been available for many years, but Microsoft supplies electronic copies of the manuals (MS-Word files) in its *Platform SDK* package. The printed manuals are definitely collectors' items.

The information in this chapter was excerpted from Chapters 1 to 3 of the *Reference* manual, with updates from the MASM 6.14 *readme.txt* file. The Microsoft license agreement supplied with this book entitles the reader to a single copy of the software and accompanying documentation, which we have, in part, printed here.

**Syntax Notation** Throughout this appendix, a consistent syntax notation is used. Words in all capital letters indicate a MASM reserved word that may appear in your program in either uppercase or lowercase letters. In the following example, `DATA` is a reserved word:

```
.DATA
```

Words in italics indicate a defined term or category. In the following example, *number* refers to an integer constant:

```
ALIGN [[ number ]]
```

When double brackets [[ .. ]] surround an item, the item is optional. In the following example, *text* is optional:

```
[[ text ]]
```

When a vertical separator | appears between items in a list of two or more items, you must select one of the items. The following example indicates a choice between NEAR and FAR:

```
NEAR | FAR
```

An ellipsis ( . . . ) indicates repetition of the last item in a list. In the next example, the comma followed by an *initializer* may repeat multiple times:

```
[[ name ]] BYTE initializer [, initializer ] . . .
```

## A.2 MASM Reserved Words

|           |         |
|-----------|---------|
| \$        | PARITY? |
| ?         | PASCAL  |
| @B        | QWORD   |
| @F        | REAL4   |
| ADDR      | REAL8   |
| BASIC     | REAL10  |
| BYTE      | SBYTE   |
| C         | SDWORD  |
| CARRY?    | SIGN?   |
| DWORD     | STDCALL |
| FAR       | SWORD   |
| FAR16     | SYSCALL |
| FORTRAN   | TBYTE   |
| FWORD     | VARARG  |
| NEAR      | WORD    |
| NEAR16    | ZERO?   |
| OVERFLOW? |         |

## A.3 Register Names

|    |     |     |     |     |
|----|-----|-----|-----|-----|
| AH | CR0 | DR1 | EBX | SI  |
| AL | CR2 | DR2 | ECX | SP  |
| AX | CR3 | DR3 | EDI | SS  |
| BH | CS  | DR6 | EDX | ST  |
| BL | CX  | DR7 | ES  | TR3 |

|    |     |     |     |     |
|----|-----|-----|-----|-----|
| BP | DH  | DS  | ESI | TR4 |
| BX | DI  | DX  | ESP | TR5 |
| CH | DL  | EAX | FS  | TR6 |
| CL | DR0 | EBP | GS  | TR7 |

## A.4 Microsoft Assembler (ML)

The ML program (*ML.EXE*) assembles and links one or more assembly language source files. The syntax is

```
ML [[options] filename [[options] filename]] . . . [[/link linkoptions]]
```

The only required parameter is at least one *filename*, the name of a source file written in assembly language. The following command, for example, assembles the source file **AddSub.asm** and produces the object file *AddSub.obj*:

```
ML -c AddSub.asm
```

The *options* parameter consists of zero or more command-line options, each starting with a slash (/) or dash (-). Multiple options must be separated by at least one space. Table A-1 lists the complete set of command-line options. The command-line options are case sensitive.

Table A-1 ML Command-Line Options.

| Option                                       | Action                                                                                                                                                                                            |
|----------------------------------------------|---------------------------------------------------------------------------------------------------------------------------------------------------------------------------------------------------|
| /AT                                          | Enables tiny-memory-model support. Enables error messages for code constructs that violate the requirements for .COM format files. Note that this is not equivalent to the .MODEL TINY directive. |
| /B filename                                  | Selects an alternate linker.                                                                                                                                                                      |
| /c                                           | Assembles only. Does not link.                                                                                                                                                                    |
| /coff                                        | Generates an object file in <i>Microsoft Common Object File Format</i> . Usually required for 32-bit assembly language, but not supported by the 64-bit assembler.                                |
| /Cp                                          | Preserves case of all user identifiers.                                                                                                                                                           |
| /Cu                                          | Maps all identifiers to uppercase. Not supported by the 64-bit assembler.                                                                                                                         |
| /Cx                                          | Preserves case in public and external symbols (default).                                                                                                                                          |
| /Dsymbol [[=value]]                          | Defines a text macro with the given name. If <i>value</i> is missing, it is blank. Multiple tokens separated by spaces must be enclosed in quotation marks.                                       |
| /EP                                          | Generates a preprocessed source listing (sent to STDOUT). See /Sf.                                                                                                                                |
| /ERRORREPORT<br>[NONE PROMPT <br>QUEUE SEND] | If the assembler fails at runtime, send diagnostic information to Microsoft.                                                                                                                      |
| /Fhexnum                                     | Sets stack size to <i>hexnum</i> bytes (this is the same as /link /STACK:number). The value must be expressed in hexadecimal notation. There must be a space between /F and <i>hexnum</i> .       |
| /Ffilename                                   | Names the executable file.                                                                                                                                                                        |
| /F [[filename]]                              | Generates an assembled code listing. See /Sf.                                                                                                                                                     |



Table A-1 (Continued)

| Option          | Action                                                                                                                                                                                                       |
|-----------------|--------------------------------------------------------------------------------------------------------------------------------------------------------------------------------------------------------------|
| /Fm[[filename]] | Creates a linker .MAP file.                                                                                                                                                                                  |
| /Fofilename     | Names an object file.                                                                                                                                                                                        |
| /FPi            | Generates emulator fixups for floating-point arithmetic (mixed-language only). Not supported by the 64-bit assembler.                                                                                        |
| /Fr[[filename]] | Generates a Source Browser .SBR file.                                                                                                                                                                        |
| /FR[[filename]] | Generates an extended form of a Source Browser .SBR file.                                                                                                                                                    |
| /Gc             | Specifies use of FORTRAN- or Pascal-style function calling and naming conventions. Not supported by the 64-bit assembler.                                                                                    |
| /Gd             | Specifies use of C-style function calling and naming conventions. Not supported by the 64-bit assembler.                                                                                                     |
| /Gz             | Use STDCALL calling connections. Not supported by the 64-bit assembler.                                                                                                                                      |
| /H number       | Restricts external names to <i>number</i> significant characters. The default is 31 characters. Not supported by the 64-bit assembler.                                                                       |
| /help           | Calls QuickHelp for help on ML.                                                                                                                                                                              |
| /I pathname     | Sets path for include file. A maximum of 10 /I options is allowed.                                                                                                                                           |
| /link           | Linker options and libraries.                                                                                                                                                                                |
| /nologo         | Suppresses messages for successful assembly.                                                                                                                                                                 |
| /omf            | Generate an OMF (Microsoft Object Module Format) file. This format is required by the older 16-bit Microsoft Linker (LINK16.EXE). Not supported by the 64-bit assembler.                                     |
| /Sa             | Turns on listing of all available information.                                                                                                                                                               |
| /safeseh        | Marks the object as either containing no exception handlers or containing exception handlers that are all declared with .SAFESEH. (In 32-bit assembly language, set this to :NO.) Not available in ml64.exe. |
| /Sf             | Adds first-pass listing to listing file.                                                                                                                                                                     |
| /SI width       | Sets the line width of source listing in characters per line. Range is 60 to 255 or 0. Default is 0. Same as PAGE <i>width</i> .                                                                             |
| /Sn             | Turns off symbol table when producing a listing.                                                                                                                                                             |
| /Sp length      | Sets the page length of source listing in lines per page. Range is 10 to 255 or 0. Default is 0. Same as PAGE <i>length</i> .                                                                                |
| /Ss text        | Specifies text for source listing. Same as SUBTITLE <i>text</i> .                                                                                                                                            |
| /St text        | Specifies title for source listing. Same as TITLE <i>text</i> .                                                                                                                                              |
| /Sx             | Turns on false conditionals in listing.                                                                                                                                                                      |
| /Ta filename    | Assembles source file whose name does not end with the .ASM extension.                                                                                                                                       |
| /w              | Same as /W0.                                                                                                                                                                                                 |
| /Wlevel         | Sets the warning level, where <i>level</i> = 0, 1, 2, or 3.                                                                                                                                                  |
| /WX             | Returns an error code if warnings are generated.                                                                                                                                                             |

Table A-1 (Continued)

| Option           | Action                                                                                   |
|------------------|------------------------------------------------------------------------------------------|
| /X               | Ignore INCLUDE Environment path.                                                         |
| /Zd              | Generates line-number information in object file.                                        |
| /Zf              | Makes all symbols public.                                                                |
| /Zi              | Generates CodeView information in object file. (For 16-bit programming only.)            |
| /Zm              | Enables M510 option for maximum compatibility with MASM 5.1.                             |
| /Zp[[alignment]] | Packs structures on the specified byte boundary. The <i>alignment</i> may be 1, 2, or 4. |
| /Zs              | Performs a syntax check only.                                                            |
| /?               | Displays a summary of ML command-line syntax.                                            |

## A.5 Microsoft Assembler Directives

**name = expression**

Assigns the numeric value of *expression* to *name*. The symbol may be redefined later.

**.386**

Enables assembly of nonprivileged instructions for the 80386 processor; disables assembly of instructions introduced with later processors. Also enables 80387 instructions.

**.386P**

Enables assembly of all instructions (including privileged) for the 80386 processor; disables assembly of instructions introduced with later processors. Also enables 80387 instructions.

**.387**

Enables assembly of instructions for the 80387 coprocessor.

**.486**

Enables assembly of nonprivileged instructions for the 80486 processor.

**.486P**

Enables assembly of all instructions (including privileged) for the 80486 processor.

**.586**

Enables assembly of nonprivileged instructions for the Pentium processor.

**.586P**

Enables assembly of all instructions (including privileged) for the Pentium processor.

**.686**

Enables assembly of nonprivileged instructions for the Pentium Pro processor.

**.686P**

Enables assembly of all instructions (including privileged) for the Pentium Pro processor.

**.8086**

Enables assembly of 8086 instructions (and the identical 8088 instructions); disables assembly of instructions introduced with later processors. Also enables 8087 instructions. This is the default mode for processors.

**.8087**

Enables assembly of 8087 instructions; disables assembly of instructions introduced with later coprocessors. This is the default mode for coprocessors.

**ALIAS <alias> = <actual-name>**

Maps an old function name to a new name. *Alias* is the alternate or alias name, and *actual-name* is the actual name of the function or procedure. The angle brackets are required. The ALIAS directive can be used for creating libraries that allow the linker (LINK) to map an old function to a new function.

**ALIGN [[number]]**

Aligns the next variable or instruction on a byte that is a multiple of *number*.

**.ALPHA**

Orders segments alphabetically.

**ASSUME *segregister:name* [[, *segregister:name*]] . . .**

**ASSUME *dataregister:type* [[, *dataregister:type*]] . . .**

**ASSUME *register:ERROR* [[, *register:ERROR*]] . . .**

**ASSUME [[*register:*] NOTHING [[, *register:NOTHING*]] . . .**

Enables error-checking for register values. After an **ASSUME** is put into effect, the assembler watches for changes to the values of the given registers. **ERROR** generates an error if the register is used. **NOTHING** removes register error-checking. You can combine different kinds of assumptions in one statement.

**.BREAK [[.IF *condition*]]**

Generates code to terminate a **.WHILE** or **.REPEAT** block if *condition* is true.

**[[*name*]] **BYTE *initializer* [[, *initializer*]] . . .****

Allocates and optionally initializes a byte of storage for each *initializer*. Can also be used as a type specifier anywhere a type is legal.

***name* **CATSTR** [[*textitem1* [[, *textitem2*]] . . . ]]**

Concatenates text items. Each text item can be a literal string, a constant preceded by a %, or the string returned by a macro function.

**.CODE [[*name*]]**

When used with **.MODEL**, indicates the start of a code segment called *name* (the default segment name is `_TEXT` for tiny, small, compact, and flat models, or `module_TEXT` for other models).

**COMM *definition* [[, *definition*]] . . .**

Creates a communal variable with the attributes specified in *definition*. Each *definition* has the following form:

```
[[langtype]] [[NEAR | FAR]] label:type[:count]]
```

The *label* is the name of the variable. The *type* can be any type specifier (**BYTE**, **WORD**, and so on) or an integer specifying the number of bytes. The *count* specifies the number of data objects (one is the default).

**COMMENT *delimiter* [[*text*]]**

```
[[text]]
```

```
[[text]] delimiter [[text]]
```

Treats all *text* between or on the same line as the delimiters as a comment.

### **.CONST**

When used with **.MODEL**, starts a constant data segment (with segment name **CONST**). This segment has the read-only attribute.

### **.CONTINUE** [[**.IF** *condition*]]

Generates code to jump to the top of a **.WHILE** or **.REPEAT** block if *condition* is true.

### **.CREF**

Enables listing of symbols in the symbol portion of the symbol table and browser file.

### **.DATA**

When used with **.MODEL**, starts a near data segment for initialized data (segment name **\_DATA**).

### **.DATA?**

When used with **.MODEL**, starts a near data segment for uninitialized data (segment name **\_BSS**).

### **.DOSSEG**

Orders the segments according to the MS-DOS segment convention: **CODE** first, then segments not in **DGROUP**, and then segments in **DGROUP**. The segments in **DGROUP** follow this order: segments not in **BSS** or **STACK**, then **BSS** segments, and finally **STACK** segments. Primarily used for ensuring CodeView support in MASM stand-alone programs. Same as **DOSSEG**.

### **DOSSEG**

Identical to **.DOSSEG**, which is the preferred form.

### **DB**

Can be used to define data like **BYTE**.

### **DD**

Can be used to define data like **DWORD**.

### **DF**

Can be used to define data like **FWORD**.

### **DQ**

Can be used to define data like **QWORD**.

### **DT**

Can be used to define data like **TBYTE**.

### **DW**

Can be used to define data like **WORD**.

[[*name*] **DWORD** *initializer* [[, *initializer*]] . . .

Allocates and optionally initializes a doubleword (4 bytes) of storage for each *initializer*. Can also be used as a type specifier anywhere a type is legal.

### **ECHO** *message*

Displays *message* to the standard output device (by default, the screen). Same as **%OUT**.

### **.ELSE**

See **.IF**.

**ELSE**

Marks the beginning of an alternate block within a conditional block. See **IF**.

**ELSEIF**

Combines **ELSE** and **IF** into one statement. See **IF**.

**ELSEIF2**

**ELSEIF** block evaluated on every assembly pass if **OPTION:SETIF2** is **TRUE**.

**END** [*address*]

Marks the end of a module and, optionally, sets the program entry point to *address*.

**.ENDIF**

See **.IF**.

**ENDIF**

See **IF**.

**ENDM**

Terminates a macro or repeat block. See **MACRO**, **FOR**, **FORC**, **REPEAT**, or **WHILE**.

*name* **ENDP**

Marks the end of procedure *name* previously begun with **PROC**. See **PROC**.

*name* **ENDS**

Marks the end of segment, structure, or union *name* previously begun with **SEGMENT**, **STRUCT**, **UNION**, or a simplified segment directive.

**.ENDW**

See **.WHILE**.

*name* **EQU** *expression*

Assigns numeric value of *expression* to *name*. The *name* cannot be redefined later.

*name* **EQU** *<text>*

Assigns specified *text* to *name*. The *name* can be assigned a different *text* later. See **TEXTEQU**.

**.ERR** [*message*]

Generates an error.

**.ERR2** [*message*]

**.ERR** block evaluated on every assembly pass if **OPTION:SETIF2** is **TRUE**.

**.ERRB** *<textitem>* [, *message*]

Generates an error if *textitem* is blank.

**.ERRDEF** *name* [, *message*]

Generates an error if *name* is a previously defined label, variable, or symbol.

**.ERRDIF**[**I**] *<textitem1>*, *<textitem2>* [, *message*]

Generates an error if the text items are different. If **I** is given, the comparison is case insensitive.

**.ERRE** *expression* [, *message*]

Generates an error if *expression* is false (0).

**.ERRIDN**[[**I**] <*textitem1*>, <*textitem2*> [[, *message*]]

Generates an error if the text items are identical. If **I** is given, the comparison is case insensitive.

**.ERRNB** <*textitem*> [[, *message*]]

Generates an error if *textitem* is not blank.

**.ERRNDEF** *name* [[, *message*]]

Generates an error if *name* has not been defined.

**.ERRNZ** *expression* [[, *message*]]

Generates an error if *expression* is true (nonzero).

**EVEN**

Aligns the next variable or instruction on an even byte.

**.EXIT** [[*expression*]]

Generates termination code. Returns optional *expression* to shell.

**EXITM** [[*textitem*]]

Terminates expansion of the current repeat or macro block and begins assembly of the next statement outside the block. In a macro function, *textitem* is the value returned.

**EXTERN** [[*langtype*] *name* [(*altid*)] :*type* [, [[*langtype*] *name* [(*altid*)] :*type*]] . . .

Defines one or more external variables, labels, or symbols called *name* whose type is *type*. The *type* can be **ABS**, which imports *name* as a constant. Same as **EXTRN**.

**EXTERNDEF** [[*langtype*] *name*:*type* [, [[*langtype*] *name*:*type*]] . . .

Defines one or more external variables, labels, or symbols called *name* whose type is *type*. If *name* is defined in the module, it is treated as **PUBLIC**. If *name* is referenced in the module, it is treated as **EXTERN**. If *name* is not referenced, it is ignored. The *type* can be **ABS**, which imports *name* as a constant. Normally used in include files.

**EXTRN**

See **EXTERN**.

**.FARDATA** [[*name*]]

When used with **.MODEL**, starts a far data segment for initialized data (segment name **FAR\_DATA** or *name*).

**.FARDATA?** [[*name*]]

When used with **.MODEL**, starts a far data segment for uninitialized data (segment name **FAR\_BSS** or *name*).

**FOR** *parameter* [[ :**REQ** | :=**default**]], <*argument* [[, *argument*]] . . . >

*statements*

**ENDM**

Marks a block that will be repeated once for each *argument*, with the current *argument* replacing *parameter* on each repetition. Same as **IRP**.

**FORC**

*parameter*, <*string*> *statements*

**ENDM**

Marks a block that will be repeated once for each character in *string*, with the current character replacing *parameter* on each repetition. Same as **IRPC**.

**[[name]] FWORD initializer** [[, *initializer*]]. . .

Allocates and optionally initializes 6 bytes of storage for each *initializer*. Also can be used as a type specifier anywhere a type is legal.

**GOTO macrolabel**

Transfers assembly to the line marked *:macrolabel*. **GOTO** is permitted only inside **MACRO**, **FOR**, **FORC**, **REPEAT**, and **WHILE** blocks. The label must be the only directive on the line and must be preceded by a leading colon.

**name GROUP segment** [[, *segment*]]. . .

Add the specified *segments* to the group called *name*. This directive has no effect when used in 32-bit flat-model programming and will result in error when used with the */coff* command-line option.

**.IF condition1**

statements

**[[.ELSEIF condition2**  
    *statements*]]

**[[.ELSE**  
    *statements*]]

**.ENDIF**

Generates code that tests *condition1* (for example, *AX > 7*) and executes the *statements* if that condition is true. If an **.ELSE** follows, its statements are executed if the original condition was false. Note that the conditions are evaluated at runtime.

**IF expression1**

*ifstatements*

**[[ELSEIF expression2**  
    *elseifstatements*]]

**[[ELSE**  
    *elsestatements*]]

**ENDIF**

Grants assembly of *ifstatements* if *expression1* is true (nonzero) or *elseifstatements* if *expression1* is false (0) and *expression2* is true. The following directives may be substituted for **ELSEIF**: **ELSEIFB**, **ELSEIFDEF**, **ELSEIFDIF**, **ELSEIFDIFI**, **ELSEIFE**, **ELSEIFIDN**, **ELSE-IFIDNI**, **ELSEIFNB**, and **ELSEIFNDEF**. Optionally, assembles *elsestatements* if the previous expression is false. Note that the expressions are evaluated at assembly time.

**IF2 expression**

**IF** block is evaluated on every assembly pass if **OPTION:SETIF2** is **TRUE**. See **IF** for complete syntax.

**IFB textitem**

Grants assembly if *textitem* is blank. See **IF** for complete syntax.

**IFDEF name**

Grants assembly if *name* is a previously defined label, variable, or symbol. See **IF** for complete syntax.

**IFDIF**[[**I**] *textitem1*, *textitem2*

Grants assembly if the text items are different. If **I** is given, the comparison is case insensitive. See **IF** for complete syntax.

**IFE** *expression*

Grants assembly if *expression* is false (0). See **IF** for complete syntax.

**IFIDN**[[**I**] *textitem1*, *textitem2*

Grants assembly if the text items are identical. If **I** is given, the comparison is case insensitive. See **IF** for complete syntax.

**IFNB** *textitem*

Grants assembly if *textitem* is not blank. See **IF** for complete syntax.

**IFDEF** *name*

Grants assembly if *name* has not been defined. See **IF** for complete syntax.

**INCLUDE** *filename*

Inserts source code from the source file given by *filename* into the current source file during assembly. The *filename* must be enclosed in angle brackets if it includes a backslash, semicolon, greater-than symbol, less-than symbol, single quotation mark, or double quotation mark.

**INCLUDELIB** *libraryname*

Informs the linker that the current module should be linked with *libraryname*. The *libraryname* must be enclosed in angle brackets if it includes a backslash, semicolon, greater-than symbol, less-than symbol, single quotation mark, or double quotation mark.

*name* **INSTR** [[*position*,] *textitem1*, *textitem2*

Finds the first occurrence of *textitem2* in *textitem1*. The starting *position* is optional. Each text item can be a literal string, a constant preceded by a %, or the string returned by a macro function.

**INVOKE** *expression* [[, *arguments*]]

Calls the procedure at the address given by *expression*, passing the arguments on the stack or in registers according to the standard calling conventions of the language type. Each argument passed to the procedure may be an expression, a register pair, or an address expression (an expression preceded by **ADDR**).

**IRP**

See **FOR**.

**IRPC**

See **FORC**.

*name* **LABEL** *type*

Creates a new label by assigning the current location-counter value and the given *type* to *name*.

*name* **LABEL** [[**NEAR** | **FAR** | **PROC**] **PTR** [*type*]]

Creates a new label by assigning the current location-counter value and the given *type* to *name*.

**.K3D**

Enables assembly of K3D instructions.



**.LALL**

See **.LISTMACROALL**.

**.LFCOND**

See **.LISTIF**.

**.LIST**

Starts listing of statements. This is the default.

**.LISTALL**

Starts listing of all statements. Equivalent to the combination of **.LIST**, **.LISTIF**, and **.LIST-MACROALL**.

**.LISTIF**

Starts listing of statements in false conditional blocks. Same as **.LFCOND**.

**.LISTMACRO**

Starts listing of macro expansion statements that generate code or data. This is the default. Same as **.XALL**.

**.LISTMACROALL**

Starts listing of all statements in macros. Same as **.LALL**.

**LOCAL *localname* [[, *localname*]]. . .**

Within a macro, **LOCAL** defines labels that are unique to each instance of the macro.

**LOCAL *label* [[ *count* ] ] [[ :*type* ] ] [[, *label* [[ *count* ] ] [[ *type* ] ]]. . .**

Within a procedure definition (**PROC**), **LOCAL** creates stack-based variables that exist for the duration of the procedure. The *label* may be a simple variable or an array containing *count* elements.

***name* MACRO [[*parameter* [[ :**REQ** | :=*default* | :**VARARG** ] ]]]. . .**

*statements*

**ENDM** [[*value*]]

Marks a macro block called *name* and establishes *parameter* placeholders for arguments passed when the macro is called. A macro function returns *value* to the calling statement.

**.MMX**

Enables assembly of MMX instructions.

**.MODEL *memorymodel* [[, *langtype* ] ] [[, *stackoption* ] ]**

Initializes the program memory model. The *memorymodel* can be **TINY**, **SMALL**, **COMPACT**, **MEDIUM**, **LARGE**, **HUGE**, or **FLAT**. The *langtype* can be **C**, **BASIC**, **FORTRAN**, **PASCAL**, **SYSCALL**, or **STDCALL**. The *stackoption* can be **NEARSTACK** or **FARSTACK**.

**NAME *modulename***

Ignored.

**.NO87**

Disallows assembly of all floating-point instructions.

**.NOCREF [[*name*[[, *name*]]. . . ] ]**

Suppresses listing of symbols in the symbol table and browser file. If names are specified, only the given names are suppressed. Same as **.XCREF**.

**.NOLIST**

Suppresses program listing. Same as **.XLIST**.

**.NOLISTIF**

Suppresses listing of conditional blocks whose condition evaluates to false (0). This is the default. Same as **.SFCOND**.

**.NOLISTMACRO**

Suppresses listing of macro expansions. Same as **.SALL**.

**OPTION *optionlist***

Enables and disables features of the assembler. Available options include **CASEMAP**, **DOTNAME**, **NODOTNAME**, **EMULATOR**, **NOEMULATOR**, **EPILOGUE**, **EXPR16**, **EXPR32**, **LANGUAGE**, **LJMP**, **NOLJMP**, **M510**, **NOM510**, **NOKEYWORD**, **NOSIGNEXTEND**, **OFFSET**, **OLDMACROS**, **NOOLDMACROS**, **OLDSTRUCTS**, **NOOLDSTRUCTS**, **PROC**, **PROLOGUE**, **READONLY**, **NOREADONLY**, **SCOPED**, **NOSCOPE**, **SEGMENT**, and **SETIF2**.

**ORG *expression***

Sets the location counter to *expression*.

**%OUT**

See **ECHO**.

**[[*name*]] OWORD *initializer* [[, *initializer*]]. . .**

Allocates and optionally initializes an octaword (16 bytes) of storage for each *initializer*. Can also be used as a type specifier anywhere a type is legal. This data type is used primarily by Streaming SIMD instructions; it holds an array of four 4-byte reals.

**PAGE [[[*length*]], *width*]]**

Sets line *length* and character *width* of the program listing. If no arguments are given, generates a page break.

**PAGE<sup>+</sup>**

Increments the section number and resets the page number to 1.

**POPCONTEXT *context***

Restores part or all of the current *context* (saved by the **PUSHCONTEXT** directive). The *context* can be **ASSUMES**, **RADIX**, **LISTING**, **CPU**, or **ALL**.

***label* PROC [[*distance*]] [[*langtype*]] [[*visibility*]] [[<*prologuearg*>]]**

[[**USES *reglist***]] [[, *parameter* [[:*tag*]]]]. . .

*statements*

*label* ENDP

Marks start and end of a procedure block called *label*. The statements in the block can be called with the **CALL** instruction or **INVOKE** directive.

***label* PROTO [[*distance*]] [[*langtype*]] [[, [[*parameter*]:*tag*]]. . .**

Prototypes a function.

**PUBLIC [[*langtype*]] *name* [[, [[*langtype*]] *name*]]. . .**

Makes each variable, label, or absolute symbol specified as *name* available to all other modules in the program.

**PURGE** *macroname* [[, *macroname*]] . .

Deletes the specified macros from memory.

**PUSHCONTEXT** *context*

Saves part or all of the current *context*: segment register assumes, radix value, listing and cref flags, or processor/coprocessor values. The *context* can be **ASSUMES**, **RADIX**, **LISTING**, **CPU**, or **ALL**.

[[*name*]] **QWORD** *initializer* [[, *initializer*]] . .

Allocates and optionally initializes 8 bytes of storage for each *initializer*. Can also be used as a type specifier anywhere a type is legal.

**.RADIX** *expression*

Sets the default radix, in the range 2 to 16, to the value of *expression*.

*name* **REAL4** *initializer* [[, *initializer*]] . .

Allocates and optionally initializes a single-precision (4-byte) floating-point number for each *initializer*.

*name* **REAL8** *initializer* [[, *initializer*]] . .

Allocates and optionally initializes a double-precision (8-byte) floating-point number for each *initializer*.

*name* **REAL10** *initializer* [[, *initializer*]] . .

Allocates and optionally initializes a 10-byte floating-point number for each *initializer*.

*recordname* **RECORD** *fieldname:width* [[= *expression*]]

[[, *fieldname:width* [[= *expression*]]] . .

Declares a record type consisting of the specified fields. The *fieldname* names the field, *width* specifies the number of bits, and *expression* gives its initial value.

**.REPEAT**

*statements*

**.UNTIL** *condition*

Generates code that repeats execution of the block of *statements* until *condition* becomes true. **.UNTILCXZ**, which becomes true when CX is zero, may be substituted for **.UNTIL**. The *condition* is optional with **.UNTILCXZ**.

**REPEAT** *expression*

*statements*

**ENDM**

Marks a block that is to be repeated *expression* times. Same as **REPT**.

**REPT**

See **REPEAT**.

**.SALL**

See **.NOLISTMACRO**.

*name* **SBYTE** *initializer* [[, *initializer*]] . .

Allocates and optionally initializes a signed byte of storage for each *initializer*. Can also be used as a type specifier anywhere a type is legal.

**name SDWORD initializer** [, *initializer*] . .

Allocates and optionally initializes a signed doubleword (4 bytes) of storage for each *initializer*. Can also be used as a type specifier anywhere a type is legal.

**name SEGMENT** [[ **READONLY** ]] [[ *align* ]] [[ *combine* ]] [[ *use* ]] [[ 'class' ]]

*statements*

**name ENDS**

Defines a program segment called *name* having segment attributes *align* (**BYTE**, **WORD**, **DWORD**, **PARA**, **PAGE**), *combine* (**PUBLIC**, **STACK**, **COMMON**, **MEMORY**, **AT address**, **PRIVATE**), *use* (**USE16**, **USE32**, **FLAT**), and *class*.

**.SEQ**

Orders segments sequentially (the default order).

**.SFCOND**

See **.NOLISTIF**.

**name SIZESTR textitem**

Finds the size of a text item.

**.STACK** [[ *size* ]]

When used with **.MODEL**, defines a stack segment (with segment name **STACK**). The optional *size* specifies the number of bytes for the stack (default 1024). The **.STACK** directive automatically closes the stack statement.

**.STARTUP**

Generates program startup code.

**STRUC**

See **STRUCT**.

**name STRUCT** [[ *alignment* ]] [[, **NONUNIQUE** ]]

*fielddeclarations*

**name ENDS**

Declares a structure type having the specified *fielddeclarations*. Each field must be a valid data definition. Same as **STRUC**.

**name SUBSTR textitem, position** [[, *length* ]]

Returns a substring of *textitem*, starting at *position*. The *textitem* can be a literal string, a constant preceded by a %, or the string returned by a macro function.

**SUBTITLE text**

Defines the listing subtitle. Same as **SUBTTL**.

**SUBTTL**

See **SUBTITLE**.

**name SWORD initializer** [, *initializer*] . .

Allocates and optionally initializes a signed word (2 bytes) of storage for each *initializer*. Can also be used as a type specifier anywhere a type is legal.

**[[name] TBYTE initializer** [[, *initializer*]]. . .

Allocates and optionally initializes 10 bytes of storage for each *initializer*. Can also be used as a type specifier anywhere a type is legal.

**name TEXTEQU** [[*textitem*]]

Assigns *textitem* to *name*. The *textitem* can be a literal string, a constant preceded by a %, or the string returned by a macro function.

**.TFCOND**

Toggles listing of false conditional blocks.

**TITLE** *text*

Defines the program listing title.

**name TYPEDEF** *type*

Defines a new type called *name*, which is equivalent to *type*.

**name UNION** [[*alignment*]] [[, NONUNIQUE]]

*fielddeclarations*

**[[name] ENDS**

Declares a union of one or more data types. The *fielddeclarations* must be valid data definitions. Omit the **ENDS** *name* label on nested **UNION** definitions.

**.UNTIL**

See **.REPEAT**.

**.UNTILCXZ**

See **.REPEAT**.

**.WHILE** *condition*

*statements*

**.ENDW**

Generates code that executes the block of *statements* while *condition* remains true.

**WHILE** *expression*

*statements*

**ENDM**

Repeats assembly of block *statements* as long as *expression* remains true.

**[[name] WORD initializer** [[, *initializer*]]. . .

Allocates and optionally initializes a word (2 bytes) of storage for each *initializer*. Can also be used as a type specifier anywhere a type is legal.

**.XALL**

See **.LISTMACRO**.

**.XCREF**

See **.NOCREF**.

**.XLIST**

See **.NOLIST**.

**.XMM**

Enables assembly of Internet Streaming SIMD Extension instructions.

## A.6 Symbols

**\$**

The current value of the location counter.

**?**

In data declarations, a value that the assembler allocates but does not initialize.

**@@:**

Defines a code label recognizable only between *label1* and *label2*, where *label1* is either start of code or the previous @@: label, and *label2* is either end of code or the next @@: label. See @B and @F.

**@B**

The location of the previous @@: label.

**@CatStr( *string1* [, *string2*. . . ] )**

Macro function that concatenates one or more strings. Returns a string.

**@code**

The name of the code segment (text macro).

**@CodeSize**

0 for TINY, SMALL, COMPACT, and FLAT models, and 1 for MEDIUM, LARGE, and HUGE models (numeric equate).

**@Cpu**

A bit mask specifying the processor mode (numeric equate).

**@CurSeg**

The name of the current segment (text macro).

**@data**

The name of the default data group. Evaluates to DGROUP for all models except FLAT. Evaluates to FLAT under the FLAT memory model (text macro).

**@DataSize**

0 for TINY, SMALL, MEDIUM, and FLAT models, 1 for COMPACT and LARGE models, and 2 for HUGE model (numeric equate).

**@Date**

The system date in the format mm/dd/yy (text macro).

**@Environ( *envvar* )**

Value of environment variable *envvar* (macro function).

**@F**

The location of the next @@: label.

**@fardata**

The name of the segment defined by the .FARDATA directive (text macro).

**@fardata?**

The name of the segment defined by the .FARDATA? directive (text macro).

**@FileCur**

The name of the current file (text macro).

**@FileName**

The base name of the main file being assembled (text macro).

**@InStr( [ *position* ], *string1*, *string2* )**

Macro function that finds the first occurrence of *string2* in *string1*, beginning at *position* within *string1*. If *position* does not appear, search begins at start of *string1*. Returns a position integer or 0 if *string2* is not found.

**@Interface**

Information about the language parameters (numeric equate).

**@Line**

The source line number in the current file (numeric equate).

**@Model**

1 for **TINY** model, 2 for **SMALL** model, 3 for **COMPACT** model, 4 for **MEDIUM** model, 5 for **LARGE** model, 6 for **HUGE** model, and 7 for **FLAT** model (numeric equate).

**@SizeStr( *string* )**

Macro function that returns the length of the given string. Returns an integer.

**@stack**

DGROUP for near stacks or STACK for far stacks (text macro).

**@SubStr( *string*, *position* [, *length* ] )**

Macro function that returns a substring starting at *position*.

**@Time**

The system time in 24-hour hh:mm:ss format (text macro).

**@Version**

610 in MASM 6.1 (text macro).

**@WordSize**

Two for a 16-bit segment or 4 for a 32-bit segment (numeric equate).

## A.7 Operators

***expression1* + *expression2***

Returns *expression1* plus *expression2*.

***expression1* – *expression2***

Returns *expression1* minus *expression2*.

***expression1* \* *expression2***

Returns *expression1* times *expression2*.

***expression1* / *expression2***

Returns *expression1* divided by *expression2*.

**–*expression***

Reverses the sign of *expression*.

***expression1* [*expression2*]**

Returns *expression1* plus [*expression2*].

***segment: expression***

Overrides the default segment of *expression* with *segment*. The *segment* can be a segment register, group name, segment name, or segment expression. The *expression* must be a constant.

***expression.field* [*.field* ] . . .**

Returns *expression* plus the offset of *field* within its structure or union.

**[*register*].*field* [*.field* ] . . .**

Returns value at the location pointed to by *register* plus the offset of *field* within its structure or union.

**<*text*>**

Treats *text* as a single literal element.

**“*text*”**

Treats “*text*” as a string.

**‘*text*’**

Treats ‘*text*’ as a string.

**!*character***

Treats *character* as a literal character rather than as an operator or symbol.

**;*text***

Treats *text* as a comment.

**;;*text***

Treats *text* as a comment in a macro that appears only in the macro definition. The listing does not show *text* where the macro is expanded.

**%*expression***

Treats the value of *expression* in a macro argument as text.

**&*parameter*&**

Replaces *parameter* with its corresponding argument value.

**ABS**

See the **EXTERNDEF** directive.

**ADDR**

See the **INVOKE** directive.

***expression1* AND *expression2***

Returns the result of a bitwise AND operation for *expression1* and *expression2*.

***count* DUP (*initialvalue* [*, initialvalue* ] . . . )**

Specifies *count* number of declarations of *initialvalue*.

***expression1* EQ *expression2***

Returns true (−1) if *expression1* equals *expression2* and returns false (0) if it does not.

***expression1* GE *expression2***

Returns true (−1) if *expression1* is greater than or equal to *expression2* and returns false (0) if it is not.

***expression1* GT *expression2***

Returns true (−1) if *expression1* is greater than *expression2* and returns false (0) if it is not.



**HIGH *expression***

Returns the high byte of *expression*.

**HIGHWORD *expression***

Returns the high word of *expression*.

***expression1* LE *expression2***

Returns true (−1) if *expression1* is less than or equal to *expression2* and returns false (0) if it is not.

**LENGTH *variable***

Returns the number of data items in *variable* created by the first initializer.

**LENGTHOF *variable***

Returns the number of data objects in *variable*.

**LOW *expression***

Returns the low byte of *expression*.

**LOWWORD *expression***

Returns the low word of *expression*.

**LROFFSET *expression***

Returns the offset of *expression*. Same as **OFFSET**, but it generates a loader resolved offset, which allows Windows to relocate code segments.

***expression1* LT *expression2***

Returns true (−1) if *expression1* is less than *expression2* and returns false (0) if it is not.

**MASK { *recordfieldname* | *record* }**

Returns a bit mask in which the bits in *recordfieldname* or *record* are set and all other bits are cleared.

***expression1* MOD *expression2***

Returns the integer value of the remainder (modulo) when dividing *expression1* by *expression2*.

***expression1* NE *expression2***

Returns true (−1) if *expression1* does not equal *expression2* and returns false (0) if it does.

**NOT *expression***

Returns *expression* with all bits reversed.

**OFFSET *expression***

Returns the offset of *expression*.

**OPATTR *expression***

Returns a word defining the mode and scope of *expression*. The low byte is identical to the byte returned by **.TYPE**. The high byte contains additional information.

***expression1* OR *expression2***

Returns the result of a bitwise OR operation for *expression1* and *expression2*.

***type* PTR *expression***

Forces the *expression* to be treated as having the specified *type*.

**[[*distance*] PTR *type***

Specifies a pointer to *type*.

**SEG *expression***

Returns the segment of *expression*.

***expression* SHL *count***

Returns the result of shifting the bits of *expression* left *count* number of bits.

**SHORT *label***

Sets the type of *label* to short. All jumps to *label* must be short (within the range -128 to +127 bytes from the jump instruction to *label*).

***expression* SHR *count***

Returns the result of shifting the bits of *expression* right *count* number of bits.

**SIZE *variable***

Returns the number of bytes in *variable* allocated by the first initializer.

**SIZEOF {*variable* | *type*}**

Returns the number of bytes in *variable* or *type*.

**THIS *type***

Returns an operand of specified *type* whose offset and segment values are equal to the current location-counter value.

**.TYPE *expression***

See OPATTR.

**TYPE *expression***

Returns the type of *expression*.

**WIDTH {*recordfieldname* | *record*}**

Returns the width in bits of the current *recordfieldname* or *record*.

***expression1* XOR *expression2***

Returns the result of a bitwise XOR operation for *expression1* and *expression2*.

## A.8 Runtime Operators

The following operators are used only within **.IF**, **.WHILE**, or **.REPEAT** blocks and are evaluated at runtime, not at assembly time:

***expression1* == *expression2***

Is equal to.

***expression1* != *expression2***

Is not equal to.

***expression1* > *expression2***

Is greater than.

***expression1* >= *expression2***

Is greater than or equal to.

***expression1* < *expression2***

Is less than.

***expression1* <= *expression2***

Is less than or equal to.

*expression1* || *expression2*

Logical OR.

*expression1* && *expression2*

Logical AND.

*expression1* & *expression2*

Bitwise AND.

!*expression*

Logical negation.

**CARRY?**

Status of Carry flag.

**OVERFLOW?**

Status of Overflow flag.

**PARITY?**

Status of Parity flag.

**SIGN?**

Status of Sign flag.

**ZERO?**

Status of Zero flag.

---

# THE x86 INSTRUCTION SET

## B.1 Introduction

### B.1.1 Flags

### B.1.2 Instruction Descriptions and Formats

## B.2 Instruction Set Details (Non Floating-Point)

## B.3 Floating-Point Instructions

## B.1 Introduction

This appendix is a quick guide to the most commonly used 32-bit x86 instructions. It does not cover system-mode instructions or instructions typically used only in operating system kernel code or protected-mode device drivers.

### B.1.1 Flags (EFlags)

Each instruction description contains a series of boxes that describe how the instruction will affect the CPU status flags. Each flag is identified by a single letter:

|   |           |   |                 |   |        |
|---|-----------|---|-----------------|---|--------|
| O | Overflow  | S | Sign            | P | Parity |
| D | Direction | Z | Zero            | C | Carry  |
| I | Interrupt | A | Auxiliary Carry |   |        |

Inside the boxes, the following notation shows how each instruction will affect the flags:

|         |                                                                        |
|---------|------------------------------------------------------------------------|
| 1       | Sets the flag.                                                         |
| 0       | Clears the flag.                                                       |
| ?       | May change the flag to an undetermined value.                          |
| (blank) | The flag is not changed.                                               |
| *       | Changes the flag according to specific rules associated with the flag. |

For example, the following diagram of the CPU flags is taken from one of the instruction descriptions:

|   |   |   |   |   |   |   |   |
|---|---|---|---|---|---|---|---|
| O | D | I | S | Z | A | P | C |
| ? |   |   | ? | ? | * | ? | * |

From the diagram, we see that the Overflow, Sign, Zero, and Parity flags will be changed to unknown values. The Auxiliary Carry and Carry flags will be modified according to rules associated with the flags. The Direction and Interrupt flags will not be changed.

### B.1.2 Instruction Descriptions and Formats

When a reference to source and destination operands is made, we use the natural order of operands in all x86 instructions, in which the first operand is the destination and the second is the source. In the MOV instruction, for example, the destination will be assigned a copy of the data in the source operand:

```
MOV destination, source
```

There may be several formats available for a single instruction. Table B-1 contains a list of symbols used in instruction formats. In the descriptions of individual instructions, we use the notation “x86” to indicate that an instruction or one of its variants is only available on processors in the 32-bit x86 family (Intel386 onward). Similarly, the notation “(80286)” indicates that at least an Intel 80286 processor must be used.

Register notations such as (E)CX, (E)SI, (E)DI, (E)SP, (E)BP, and (E)IP differentiate between x86 processors that use the 32-bit registers and all earlier processors that used 16-bit registers.

Table B-1 Symbols Used in Instruction Formats.

| Symbol                    | Description                                                                                                                                                                 |
|---------------------------|-----------------------------------------------------------------------------------------------------------------------------------------------------------------------------|
| <i>reg</i>                | An 8-, 16-, or 32-bit general register from the following list: AH, AL, BH, BL, CH, CL, DH, DL, AX, BX, CX, DX, SI, DI, BP, SP, EAX, EBX, ECX, EDX, ESI, EDI, EBP, and ESP. |
| <i>reg8, reg16, reg32</i> | A general register, identified by its number of bits.                                                                                                                       |
| <i>segreg</i>             | A 16-bit segment register (CS, DS, ES, SS, FS, GS).                                                                                                                         |
| <i>accum</i>              | AL, AX, or EAX.                                                                                                                                                             |
| <i>mem</i>                | A memory operand, using any of the standard memory-addressing modes.                                                                                                        |
| <i>mem8, mem16, mem32</i> | A memory operand, identified by its number of bits.                                                                                                                         |
| <i>shortlabel</i>         | A location in the code segment within $-128$ to $+127$ bytes of the current location.                                                                                       |
| <i>nearlabel</i>          | A location in the current code segment, identified by a label.                                                                                                              |
| <i>farlabel</i>           | A location in an external code segment, identified by a label.                                                                                                              |

Table B-1 (Continued)

| Symbol                    | Description                                             |
|---------------------------|---------------------------------------------------------|
| <i>imm</i>                | An immediate operand.                                   |
| <i>imm8, imm16, imm32</i> | An immediate operand, identified by its number of bits. |
| <i>instruction</i>        | An 80x86 assembly language instruction.                 |

## B.2 Instruction Set Details (Non Floating-Point)

|                                                                                                                                                                                                                                                                 |                                                                                                                                                                                                                                                                                                                                                                                                                                                                                                                                                                         |   |   |   |   |   |   |   |   |   |  |  |   |   |   |   |   |
|-----------------------------------------------------------------------------------------------------------------------------------------------------------------------------------------------------------------------------------------------------------------|-------------------------------------------------------------------------------------------------------------------------------------------------------------------------------------------------------------------------------------------------------------------------------------------------------------------------------------------------------------------------------------------------------------------------------------------------------------------------------------------------------------------------------------------------------------------------|---|---|---|---|---|---|---|---|---|--|--|---|---|---|---|---|
| <b>AAA</b>                                                                                                                                                                                                                                                      | <p><b>ASCII Adjust After Addition</b></p> <table style="margin-left: auto; margin-right: auto;"> <tr> <td>O</td><td>D</td><td>I</td><td>S</td><td>Z</td><td>A</td><td>P</td><td>C</td> </tr> <tr> <td style="border: 1px solid black;">?</td><td style="border: 1px solid black;"></td><td style="border: 1px solid black;"></td><td style="border: 1px solid black;">?</td><td style="border: 1px solid black;">?</td><td style="border: 1px solid black;">*</td><td style="border: 1px solid black;">?</td><td style="border: 1px solid black;">*</td> </tr> </table> | O | D | I | S | Z | A | P | C | ? |  |  | ? | ? | * | ? | * |
|                                                                                                                                                                                                                                                                 | O                                                                                                                                                                                                                                                                                                                                                                                                                                                                                                                                                                       | D | I | S | Z | A | P | C |   |   |  |  |   |   |   |   |   |
| ?                                                                                                                                                                                                                                                               |                                                                                                                                                                                                                                                                                                                                                                                                                                                                                                                                                                         |   | ? | ? | * | ? | * |   |   |   |  |  |   |   |   |   |   |
| <p>Adjusts the result in AL after two ASCII digits have been added together. If AL &gt; 9, the high digit of the result is placed in AH, and the Carry and Auxiliary Carry flags are set.</p> <p>Instruction format:</p> <p style="text-align: center;">AAA</p> |                                                                                                                                                                                                                                                                                                                                                                                                                                                                                                                                                                         |   |   |   |   |   |   |   |   |   |  |  |   |   |   |   |   |

|                                                                                                                                                                                     |                                                                                                                                                                                                                                                                                                                                                                                                                                                                                                                                                                          |   |   |   |   |   |   |   |   |   |  |  |   |   |   |   |   |
|-------------------------------------------------------------------------------------------------------------------------------------------------------------------------------------|--------------------------------------------------------------------------------------------------------------------------------------------------------------------------------------------------------------------------------------------------------------------------------------------------------------------------------------------------------------------------------------------------------------------------------------------------------------------------------------------------------------------------------------------------------------------------|---|---|---|---|---|---|---|---|---|--|--|---|---|---|---|---|
| <b>AAD</b>                                                                                                                                                                          | <p><b>ASCII Adjust Before Division</b></p> <table style="margin-left: auto; margin-right: auto;"> <tr> <td>O</td><td>D</td><td>I</td><td>S</td><td>Z</td><td>A</td><td>P</td><td>C</td> </tr> <tr> <td style="border: 1px solid black;">?</td><td style="border: 1px solid black;"></td><td style="border: 1px solid black;"></td><td style="border: 1px solid black;">*</td><td style="border: 1px solid black;">*</td><td style="border: 1px solid black;">?</td><td style="border: 1px solid black;">*</td><td style="border: 1px solid black;">?</td> </tr> </table> | O | D | I | S | Z | A | P | C | ? |  |  | * | * | ? | * | ? |
|                                                                                                                                                                                     | O                                                                                                                                                                                                                                                                                                                                                                                                                                                                                                                                                                        | D | I | S | Z | A | P | C |   |   |  |  |   |   |   |   |   |
| ?                                                                                                                                                                                   |                                                                                                                                                                                                                                                                                                                                                                                                                                                                                                                                                                          |   | * | * | ? | * | ? |   |   |   |  |  |   |   |   |   |   |
| <p>Converts unpacked BCD digits in AH and AL to a single binary value in preparation for the DIV instruction.</p> <p>Instruction format:</p> <p style="text-align: center;">AAD</p> |                                                                                                                                                                                                                                                                                                                                                                                                                                                                                                                                                                          |   |   |   |   |   |   |   |   |   |  |  |   |   |   |   |   |

|                                                                                                                                                                |                                                                                                                                                                                                                                                                                                                                                                                                                                                                                                                                                                         |   |   |   |   |   |   |   |   |   |  |  |   |   |   |   |   |
|----------------------------------------------------------------------------------------------------------------------------------------------------------------|-------------------------------------------------------------------------------------------------------------------------------------------------------------------------------------------------------------------------------------------------------------------------------------------------------------------------------------------------------------------------------------------------------------------------------------------------------------------------------------------------------------------------------------------------------------------------|---|---|---|---|---|---|---|---|---|--|--|---|---|---|---|---|
| <b>AAM</b>                                                                                                                                                     | <p><b>ASCII Adjust After Multiply</b></p> <table style="margin-left: auto; margin-right: auto;"> <tr> <td>O</td><td>D</td><td>I</td><td>S</td><td>Z</td><td>A</td><td>P</td><td>C</td> </tr> <tr> <td style="border: 1px solid black;">?</td><td style="border: 1px solid black;"></td><td style="border: 1px solid black;"></td><td style="border: 1px solid black;">*</td><td style="border: 1px solid black;">*</td><td style="border: 1px solid black;">?</td><td style="border: 1px solid black;">*</td><td style="border: 1px solid black;">?</td> </tr> </table> | O | D | I | S | Z | A | P | C | ? |  |  | * | * | ? | * | ? |
|                                                                                                                                                                | O                                                                                                                                                                                                                                                                                                                                                                                                                                                                                                                                                                       | D | I | S | Z | A | P | C |   |   |  |  |   |   |   |   |   |
| ?                                                                                                                                                              |                                                                                                                                                                                                                                                                                                                                                                                                                                                                                                                                                                         |   | * | * | ? | * | ? |   |   |   |  |  |   |   |   |   |   |
| <p>Adjusts the result in AX after two unpacked BCD digits have been multiplied together.</p> <p>Instruction format:</p> <p style="text-align: center;">AAM</p> |                                                                                                                                                                                                                                                                                                                                                                                                                                                                                                                                                                         |   |   |   |   |   |   |   |   |   |  |  |   |   |   |   |   |

|                                                                                                                                                                                                                       |                                                                                                                                                                                                                   |   |   |   |   |   |   |   |   |   |  |  |   |   |   |   |
|-----------------------------------------------------------------------------------------------------------------------------------------------------------------------------------------------------------------------|-------------------------------------------------------------------------------------------------------------------------------------------------------------------------------------------------------------------|---|---|---|---|---|---|---|---|---|--|--|---|---|---|---|
| <b>AAS</b>                                                                                                                                                                                                            | <b>ASCII Adjust After Subtraction</b>                                                                                                                                                                             |   |   |   |   |   |   |   |   |   |  |  |   |   |   |   |
|                                                                                                                                                                                                                       | <table border="1"> <tr> <td>O</td><td>D</td><td>I</td><td>S</td><td>Z</td><td>A</td><td>P</td><td>C</td> </tr> <tr> <td>?</td><td></td><td></td><td>?</td><td>?</td><td>*</td><td>?</td><td>*</td> </tr> </table> | O | D | I | S | Z | A | P | C | ? |  |  | ? | ? | * | ? |
| O                                                                                                                                                                                                                     | D                                                                                                                                                                                                                 | I | S | Z | A | P | C |   |   |   |  |  |   |   |   |   |
| ?                                                                                                                                                                                                                     |                                                                                                                                                                                                                   |   | ? | ? | * | ? | * |   |   |   |  |  |   |   |   |   |
| <p>Adjusts the result in AX after a subtraction operation. If AL &gt; 9, AAS decrements AH and sets the Carry and Auxiliary Carry flags.</p> <p>Instruction format:</p> <p style="text-align: center;"><b>AAS</b></p> |                                                                                                                                                                                                                   |   |   |   |   |   |   |   |   |   |  |  |   |   |   |   |

|                                                                                                                                                                                                                                                                                                                                                                                                                                                                                                       |                                                                                                                                                                                                                   |                            |                            |                            |                            |                            |                              |   |   |   |  |  |   |   |   |   |
|-------------------------------------------------------------------------------------------------------------------------------------------------------------------------------------------------------------------------------------------------------------------------------------------------------------------------------------------------------------------------------------------------------------------------------------------------------------------------------------------------------|-------------------------------------------------------------------------------------------------------------------------------------------------------------------------------------------------------------------|----------------------------|----------------------------|----------------------------|----------------------------|----------------------------|------------------------------|---|---|---|--|--|---|---|---|---|
| <b>ADC</b>                                                                                                                                                                                                                                                                                                                                                                                                                                                                                            | <b>Add Carry</b>                                                                                                                                                                                                  |                            |                            |                            |                            |                            |                              |   |   |   |  |  |   |   |   |   |
|                                                                                                                                                                                                                                                                                                                                                                                                                                                                                                       | <table border="1"> <tr> <td>O</td><td>D</td><td>I</td><td>S</td><td>Z</td><td>A</td><td>P</td><td>C</td> </tr> <tr> <td>*</td><td></td><td></td><td>*</td><td>*</td><td>*</td><td>*</td><td>*</td> </tr> </table> | O                          | D                          | I                          | S                          | Z                          | A                            | P | C | * |  |  | * | * | * | * |
| O                                                                                                                                                                                                                                                                                                                                                                                                                                                                                                     | D                                                                                                                                                                                                                 | I                          | S                          | Z                          | A                          | P                          | C                            |   |   |   |  |  |   |   |   |   |
| *                                                                                                                                                                                                                                                                                                                                                                                                                                                                                                     |                                                                                                                                                                                                                   |                            | *                          | *                          | *                          | *                          | *                            |   |   |   |  |  |   |   |   |   |
| <p>Adds both the source operand and the Carry flag to the destination operand. Operands must be the same size.</p> <p>Instruction formats:</p> <table style="width: 100%; border: none;"> <tr> <td style="width: 50%;"><b>ADC</b> <i>reg, reg</i></td> <td style="width: 50%;"><b>ADC</b> <i>reg, imm</i></td> </tr> <tr> <td><b>ADC</b> <i>mem, reg</i></td> <td><b>ADC</b> <i>mem, imm</i></td> </tr> <tr> <td><b>ADC</b> <i>reg, mem</i></td> <td><b>ADC</b> <i>accum, imm</i></td> </tr> </table> |                                                                                                                                                                                                                   | <b>ADC</b> <i>reg, reg</i> | <b>ADC</b> <i>reg, imm</i> | <b>ADC</b> <i>mem, reg</i> | <b>ADC</b> <i>mem, imm</i> | <b>ADC</b> <i>reg, mem</i> | <b>ADC</b> <i>accum, imm</i> |   |   |   |  |  |   |   |   |   |
| <b>ADC</b> <i>reg, reg</i>                                                                                                                                                                                                                                                                                                                                                                                                                                                                            | <b>ADC</b> <i>reg, imm</i>                                                                                                                                                                                        |                            |                            |                            |                            |                            |                              |   |   |   |  |  |   |   |   |   |
| <b>ADC</b> <i>mem, reg</i>                                                                                                                                                                                                                                                                                                                                                                                                                                                                            | <b>ADC</b> <i>mem, imm</i>                                                                                                                                                                                        |                            |                            |                            |                            |                            |                              |   |   |   |  |  |   |   |   |   |
| <b>ADC</b> <i>reg, mem</i>                                                                                                                                                                                                                                                                                                                                                                                                                                                                            | <b>ADC</b> <i>accum, imm</i>                                                                                                                                                                                      |                            |                            |                            |                            |                            |                              |   |   |   |  |  |   |   |   |   |

|                                                                                                                                                                                                                                                                                                                                                                                                                                                                                                                         |                                                                                                                                                                                                                   |                            |                            |                            |                            |                            |                              |   |   |   |  |  |   |   |   |   |
|-------------------------------------------------------------------------------------------------------------------------------------------------------------------------------------------------------------------------------------------------------------------------------------------------------------------------------------------------------------------------------------------------------------------------------------------------------------------------------------------------------------------------|-------------------------------------------------------------------------------------------------------------------------------------------------------------------------------------------------------------------|----------------------------|----------------------------|----------------------------|----------------------------|----------------------------|------------------------------|---|---|---|--|--|---|---|---|---|
| <b>ADD</b>                                                                                                                                                                                                                                                                                                                                                                                                                                                                                                              | <b>Add</b>                                                                                                                                                                                                        |                            |                            |                            |                            |                            |                              |   |   |   |  |  |   |   |   |   |
|                                                                                                                                                                                                                                                                                                                                                                                                                                                                                                                         | <table border="1"> <tr> <td>O</td><td>D</td><td>I</td><td>S</td><td>Z</td><td>A</td><td>P</td><td>C</td> </tr> <tr> <td>*</td><td></td><td></td><td>*</td><td>*</td><td>*</td><td>*</td><td>*</td> </tr> </table> | O                          | D                          | I                          | S                          | Z                          | A                            | P | C | * |  |  | * | * | * | * |
| O                                                                                                                                                                                                                                                                                                                                                                                                                                                                                                                       | D                                                                                                                                                                                                                 | I                          | S                          | Z                          | A                          | P                          | C                            |   |   |   |  |  |   |   |   |   |
| *                                                                                                                                                                                                                                                                                                                                                                                                                                                                                                                       |                                                                                                                                                                                                                   |                            | *                          | *                          | *                          | *                          | *                            |   |   |   |  |  |   |   |   |   |
| <p>A source operand is added to a destination operand, and the sum is stored in the destination. Operands must be the same size.</p> <p>Instruction formats:</p> <table style="width: 100%; border: none;"> <tr> <td style="width: 50%;"><b>ADD</b> <i>reg, reg</i></td> <td style="width: 50%;"><b>ADD</b> <i>reg, imm</i></td> </tr> <tr> <td><b>ADD</b> <i>mem, reg</i></td> <td><b>ADD</b> <i>mem, imm</i></td> </tr> <tr> <td><b>ADD</b> <i>reg, mem</i></td> <td><b>ADD</b> <i>accum, imm</i></td> </tr> </table> |                                                                                                                                                                                                                   | <b>ADD</b> <i>reg, reg</i> | <b>ADD</b> <i>reg, imm</i> | <b>ADD</b> <i>mem, reg</i> | <b>ADD</b> <i>mem, imm</i> | <b>ADD</b> <i>reg, mem</i> | <b>ADD</b> <i>accum, imm</i> |   |   |   |  |  |   |   |   |   |
| <b>ADD</b> <i>reg, reg</i>                                                                                                                                                                                                                                                                                                                                                                                                                                                                                              | <b>ADD</b> <i>reg, imm</i>                                                                                                                                                                                        |                            |                            |                            |                            |                            |                              |   |   |   |  |  |   |   |   |   |
| <b>ADD</b> <i>mem, reg</i>                                                                                                                                                                                                                                                                                                                                                                                                                                                                                              | <b>ADD</b> <i>mem, imm</i>                                                                                                                                                                                        |                            |                            |                            |                            |                            |                              |   |   |   |  |  |   |   |   |   |
| <b>ADD</b> <i>reg, mem</i>                                                                                                                                                                                                                                                                                                                                                                                                                                                                                              | <b>ADD</b> <i>accum, imm</i>                                                                                                                                                                                      |                            |                            |                            |                            |                            |                              |   |   |   |  |  |   |   |   |   |

|                                                                                                                                                                                                                                                                                                                                                                                                                                                                                          |                                                                                                                                                                                                                   |                            |                            |                            |                            |                            |                              |   |   |   |  |  |   |   |   |   |
|------------------------------------------------------------------------------------------------------------------------------------------------------------------------------------------------------------------------------------------------------------------------------------------------------------------------------------------------------------------------------------------------------------------------------------------------------------------------------------------|-------------------------------------------------------------------------------------------------------------------------------------------------------------------------------------------------------------------|----------------------------|----------------------------|----------------------------|----------------------------|----------------------------|------------------------------|---|---|---|--|--|---|---|---|---|
| <b>AND</b>                                                                                                                                                                                                                                                                                                                                                                                                                                                                               | <b>Logical AND</b>                                                                                                                                                                                                |                            |                            |                            |                            |                            |                              |   |   |   |  |  |   |   |   |   |
|                                                                                                                                                                                                                                                                                                                                                                                                                                                                                          | <table border="1"> <tr> <td>O</td><td>D</td><td>I</td><td>S</td><td>Z</td><td>A</td><td>P</td><td>C</td> </tr> <tr> <td>*</td><td></td><td></td><td>*</td><td>*</td><td>?</td><td>*</td><td>0</td> </tr> </table> | O                          | D                          | I                          | S                          | Z                          | A                            | P | C | * |  |  | * | * | ? | * |
| O                                                                                                                                                                                                                                                                                                                                                                                                                                                                                        | D                                                                                                                                                                                                                 | I                          | S                          | Z                          | A                          | P                          | C                            |   |   |   |  |  |   |   |   |   |
| *                                                                                                                                                                                                                                                                                                                                                                                                                                                                                        |                                                                                                                                                                                                                   |                            | *                          | *                          | ?                          | *                          | 0                            |   |   |   |  |  |   |   |   |   |
| <p>Each bit in the destination operand is ANDed with the corresponding bit in the source operand.</p> <p>Instruction formats:</p> <table style="width: 100%; border: none;"> <tr> <td style="width: 50%;"><b>AND</b> <i>reg, reg</i></td> <td style="width: 50%;"><b>AND</b> <i>reg, imm</i></td> </tr> <tr> <td><b>AND</b> <i>mem, reg</i></td> <td><b>AND</b> <i>mem, imm</i></td> </tr> <tr> <td><b>AND</b> <i>reg, mem</i></td> <td><b>AND</b> <i>accum, imm</i></td> </tr> </table> |                                                                                                                                                                                                                   | <b>AND</b> <i>reg, reg</i> | <b>AND</b> <i>reg, imm</i> | <b>AND</b> <i>mem, reg</i> | <b>AND</b> <i>mem, imm</i> | <b>AND</b> <i>reg, mem</i> | <b>AND</b> <i>accum, imm</i> |   |   |   |  |  |   |   |   |   |
| <b>AND</b> <i>reg, reg</i>                                                                                                                                                                                                                                                                                                                                                                                                                                                               | <b>AND</b> <i>reg, imm</i>                                                                                                                                                                                        |                            |                            |                            |                            |                            |                              |   |   |   |  |  |   |   |   |   |
| <b>AND</b> <i>mem, reg</i>                                                                                                                                                                                                                                                                                                                                                                                                                                                               | <b>AND</b> <i>mem, imm</i>                                                                                                                                                                                        |                            |                            |                            |                            |                            |                              |   |   |   |  |  |   |   |   |   |
| <b>AND</b> <i>reg, mem</i>                                                                                                                                                                                                                                                                                                                                                                                                                                                               | <b>AND</b> <i>accum, imm</i>                                                                                                                                                                                      |                            |                            |                            |                            |                            |                              |   |   |   |  |  |   |   |   |   |

|                                                                                                                                                                                                                                                                                                                                                                                                                                                                                                                                                                                                                                            |                                                                                                                                                                                                                                                                                                                                                                                                                                                                                                                                                                                                                                                                                                                                                                                                                                                                                                                                                                                                                            |   |   |   |   |   |   |   |   |  |  |  |  |  |  |  |  |
|--------------------------------------------------------------------------------------------------------------------------------------------------------------------------------------------------------------------------------------------------------------------------------------------------------------------------------------------------------------------------------------------------------------------------------------------------------------------------------------------------------------------------------------------------------------------------------------------------------------------------------------------|----------------------------------------------------------------------------------------------------------------------------------------------------------------------------------------------------------------------------------------------------------------------------------------------------------------------------------------------------------------------------------------------------------------------------------------------------------------------------------------------------------------------------------------------------------------------------------------------------------------------------------------------------------------------------------------------------------------------------------------------------------------------------------------------------------------------------------------------------------------------------------------------------------------------------------------------------------------------------------------------------------------------------|---|---|---|---|---|---|---|---|--|--|--|--|--|--|--|--|
| <b>BOUND</b>                                                                                                                                                                                                                                                                                                                                                                                                                                                                                                                                                                                                                               | <p><b>Check Array Bounds (80286)</b></p> <table style="margin-left: auto; margin-right: auto; border-collapse: collapse;"> <tr> <td style="padding: 0 5px;">O</td><td style="padding: 0 5px;">D</td><td style="padding: 0 5px;">I</td><td style="padding: 0 5px;">S</td><td style="padding: 0 5px;">Z</td><td style="padding: 0 5px;">A</td><td style="padding: 0 5px;">P</td><td style="padding: 0 5px;">C</td> </tr> <tr> <td style="border: 1px solid black; width: 20px; height: 15px;"></td> <td style="border: 1px solid black; width: 20px; height: 15px;"></td> <td style="border: 1px solid black; width: 20px; height: 15px;"></td> <td style="border: 1px solid black; width: 20px; height: 15px;"></td> <td style="border: 1px solid black; width: 20px; height: 15px;"></td> <td style="border: 1px solid black; width: 20px; height: 15px;"></td> <td style="border: 1px solid black; width: 20px; height: 15px;"></td> <td style="border: 1px solid black; width: 20px; height: 15px;"></td> </tr> </table> | O | D | I | S | Z | A | P | C |  |  |  |  |  |  |  |  |
|                                                                                                                                                                                                                                                                                                                                                                                                                                                                                                                                                                                                                                            | O                                                                                                                                                                                                                                                                                                                                                                                                                                                                                                                                                                                                                                                                                                                                                                                                                                                                                                                                                                                                                          | D | I | S | Z | A | P | C |   |  |  |  |  |  |  |  |  |
|                                                                                                                                                                                                                                                                                                                                                                                                                                                                                                                                                                                                                                            |                                                                                                                                                                                                                                                                                                                                                                                                                                                                                                                                                                                                                                                                                                                                                                                                                                                                                                                                                                                                                            |   |   |   |   |   |   |   |   |  |  |  |  |  |  |  |  |
| <p>Verifies that a signed index value is within the bounds of an array. On the 80286 processor, the destination operand can be any 16-bit register containing the index to be checked. The source operand must be a 32-bit memory operand in which the high and low words contain the upper and lower bounds of the index value. On the x86 processor, the destination can be a 32-bit register and the source can be a 64-bit memory operand.</p> <p>Instruction formats:</p> <p style="text-align: center;"> <span style="margin-right: 150px;"><b>BOUND</b> <i>reg16, mem32</i></span> <span><b>BOUND</b> <i>r32, mem64</i></span> </p> |                                                                                                                                                                                                                                                                                                                                                                                                                                                                                                                                                                                                                                                                                                                                                                                                                                                                                                                                                                                                                            |   |   |   |   |   |   |   |   |  |  |  |  |  |  |  |  |

|                                                                                                                                                                                                                                                                                                                                                                                                                                                                                                                                                         |                                                                                                                                                                                                                                                                                                                                                                                                                                                                                                                                                                                                                                                                                                                                                                                                                                                                                                                                                                                                                                                                                                                                              |   |   |   |   |   |   |   |   |   |  |  |   |   |   |   |   |
|---------------------------------------------------------------------------------------------------------------------------------------------------------------------------------------------------------------------------------------------------------------------------------------------------------------------------------------------------------------------------------------------------------------------------------------------------------------------------------------------------------------------------------------------------------|----------------------------------------------------------------------------------------------------------------------------------------------------------------------------------------------------------------------------------------------------------------------------------------------------------------------------------------------------------------------------------------------------------------------------------------------------------------------------------------------------------------------------------------------------------------------------------------------------------------------------------------------------------------------------------------------------------------------------------------------------------------------------------------------------------------------------------------------------------------------------------------------------------------------------------------------------------------------------------------------------------------------------------------------------------------------------------------------------------------------------------------------|---|---|---|---|---|---|---|---|---|--|--|---|---|---|---|---|
| <b>BSF,<br/>BSR</b>                                                                                                                                                                                                                                                                                                                                                                                                                                                                                                                                     | <p><b>Bit Scan (x86)</b></p> <table style="margin-left: auto; margin-right: auto; border-collapse: collapse;"> <tr> <td style="padding: 0 5px;">O</td><td style="padding: 0 5px;">D</td><td style="padding: 0 5px;">I</td><td style="padding: 0 5px;">S</td><td style="padding: 0 5px;">Z</td><td style="padding: 0 5px;">A</td><td style="padding: 0 5px;">P</td><td style="padding: 0 5px;">C</td> </tr> <tr> <td style="border: 1px solid black; width: 20px; height: 15px; text-align: center;">?</td> <td style="border: 1px solid black; width: 20px; height: 15px;"></td> <td style="border: 1px solid black; width: 20px; height: 15px;"></td> <td style="border: 1px solid black; width: 20px; height: 15px; text-align: center;">?</td> <td style="border: 1px solid black; width: 20px; height: 15px; text-align: center;">?</td> <td style="border: 1px solid black; width: 20px; height: 15px; text-align: center;">?</td> <td style="border: 1px solid black; width: 20px; height: 15px; text-align: center;">?</td> <td style="border: 1px solid black; width: 20px; height: 15px; text-align: center;">?</td> </tr> </table> | O | D | I | S | Z | A | P | C | ? |  |  | ? | ? | ? | ? | ? |
|                                                                                                                                                                                                                                                                                                                                                                                                                                                                                                                                                         | O                                                                                                                                                                                                                                                                                                                                                                                                                                                                                                                                                                                                                                                                                                                                                                                                                                                                                                                                                                                                                                                                                                                                            | D | I | S | Z | A | P | C |   |   |  |  |   |   |   |   |   |
| ?                                                                                                                                                                                                                                                                                                                                                                                                                                                                                                                                                       |                                                                                                                                                                                                                                                                                                                                                                                                                                                                                                                                                                                                                                                                                                                                                                                                                                                                                                                                                                                                                                                                                                                                              |   | ? | ? | ? | ? | ? |   |   |   |  |  |   |   |   |   |   |
| <p>Scans an operand to find the first set bit. If the bit is found, the Zero flag is cleared, and the destination operand is assigned the bit number (index) of the first set bit encountered. If no set bit is found, ZF = 1. BSF scans from bit 0 to the highest bit, and BSR starts at the highest bit and scans toward bit 0.</p> <p>Instruction formats (apply to both BSF and BSR):</p> <p style="text-align: center;"> <span style="margin-right: 150px;"><b>BSF</b> <i>reg16, r/m16</i></span> <span><b>BSF</b> <i>reg32, r/m32</i></span> </p> |                                                                                                                                                                                                                                                                                                                                                                                                                                                                                                                                                                                                                                                                                                                                                                                                                                                                                                                                                                                                                                                                                                                                              |   |   |   |   |   |   |   |   |   |  |  |   |   |   |   |   |

|                                                                                                                                                          |                                                                                                                                                                                                                                                                                                                                                                                                                                                                                                                                                                                                                                                                                                                                                                                                                                                                                                                                                                                                                 |   |   |   |   |   |   |   |   |  |  |  |  |  |  |  |  |
|----------------------------------------------------------------------------------------------------------------------------------------------------------|-----------------------------------------------------------------------------------------------------------------------------------------------------------------------------------------------------------------------------------------------------------------------------------------------------------------------------------------------------------------------------------------------------------------------------------------------------------------------------------------------------------------------------------------------------------------------------------------------------------------------------------------------------------------------------------------------------------------------------------------------------------------------------------------------------------------------------------------------------------------------------------------------------------------------------------------------------------------------------------------------------------------|---|---|---|---|---|---|---|---|--|--|--|--|--|--|--|--|
| <b>BSWAP</b>                                                                                                                                             | <p><b>Byte Swap (x86)</b></p> <table style="margin-left: auto; margin-right: auto; border-collapse: collapse;"> <tr> <td style="padding: 0 5px;">O</td><td style="padding: 0 5px;">D</td><td style="padding: 0 5px;">I</td><td style="padding: 0 5px;">S</td><td style="padding: 0 5px;">Z</td><td style="padding: 0 5px;">A</td><td style="padding: 0 5px;">P</td><td style="padding: 0 5px;">C</td> </tr> <tr> <td style="border: 1px solid black; width: 20px; height: 15px;"></td> <td style="border: 1px solid black; width: 20px; height: 15px;"></td> <td style="border: 1px solid black; width: 20px; height: 15px;"></td> <td style="border: 1px solid black; width: 20px; height: 15px;"></td> <td style="border: 1px solid black; width: 20px; height: 15px;"></td> <td style="border: 1px solid black; width: 20px; height: 15px;"></td> <td style="border: 1px solid black; width: 20px; height: 15px;"></td> <td style="border: 1px solid black; width: 20px; height: 15px;"></td> </tr> </table> | O | D | I | S | Z | A | P | C |  |  |  |  |  |  |  |  |
|                                                                                                                                                          | O                                                                                                                                                                                                                                                                                                                                                                                                                                                                                                                                                                                                                                                                                                                                                                                                                                                                                                                                                                                                               | D | I | S | Z | A | P | C |   |  |  |  |  |  |  |  |  |
|                                                                                                                                                          |                                                                                                                                                                                                                                                                                                                                                                                                                                                                                                                                                                                                                                                                                                                                                                                                                                                                                                                                                                                                                 |   |   |   |   |   |   |   |   |  |  |  |  |  |  |  |  |
| <p>Reverses the byte order of a 32-bit destination register.</p> <p>Instruction format:</p> <p style="text-align: center;"><b>BSWAP</b> <i>reg32</i></p> |                                                                                                                                                                                                                                                                                                                                                                                                                                                                                                                                                                                                                                                                                                                                                                                                                                                                                                                                                                                                                 |   |   |   |   |   |   |   |   |  |  |  |  |  |  |  |  |

|                                                                                                                                                                                                                                                                                                                                                                                                                                                                                                                                                                                                                                                                                                                                                                                                                                                                                |                                                                                                                                                                                                                                                                                                                                                                                                                                                                                                                                                                                                                                                                                                                                                                                                                                                                                                                                                                                                                                                                                                                                               |   |   |   |   |   |   |   |   |   |  |  |   |   |   |   |   |
|--------------------------------------------------------------------------------------------------------------------------------------------------------------------------------------------------------------------------------------------------------------------------------------------------------------------------------------------------------------------------------------------------------------------------------------------------------------------------------------------------------------------------------------------------------------------------------------------------------------------------------------------------------------------------------------------------------------------------------------------------------------------------------------------------------------------------------------------------------------------------------|-----------------------------------------------------------------------------------------------------------------------------------------------------------------------------------------------------------------------------------------------------------------------------------------------------------------------------------------------------------------------------------------------------------------------------------------------------------------------------------------------------------------------------------------------------------------------------------------------------------------------------------------------------------------------------------------------------------------------------------------------------------------------------------------------------------------------------------------------------------------------------------------------------------------------------------------------------------------------------------------------------------------------------------------------------------------------------------------------------------------------------------------------|---|---|---|---|---|---|---|---|---|--|--|---|---|---|---|---|
| <b>BT,<br/>BTC,<br/>BTR,<br/>BTS</b>                                                                                                                                                                                                                                                                                                                                                                                                                                                                                                                                                                                                                                                                                                                                                                                                                                           | <p><b>Bit Tests (x86)</b></p> <table style="margin-left: auto; margin-right: auto; border-collapse: collapse;"> <tr> <td style="padding: 0 5px;">O</td><td style="padding: 0 5px;">D</td><td style="padding: 0 5px;">I</td><td style="padding: 0 5px;">S</td><td style="padding: 0 5px;">Z</td><td style="padding: 0 5px;">A</td><td style="padding: 0 5px;">P</td><td style="padding: 0 5px;">C</td> </tr> <tr> <td style="border: 1px solid black; width: 20px; height: 15px; text-align: center;">?</td> <td style="border: 1px solid black; width: 20px; height: 15px;"></td> <td style="border: 1px solid black; width: 20px; height: 15px;"></td> <td style="border: 1px solid black; width: 20px; height: 15px; text-align: center;">?</td> <td style="border: 1px solid black; width: 20px; height: 15px; text-align: center;">?</td> <td style="border: 1px solid black; width: 20px; height: 15px; text-align: center;">?</td> <td style="border: 1px solid black; width: 20px; height: 15px; text-align: center;">?</td> <td style="border: 1px solid black; width: 20px; height: 15px; text-align: center;">*</td> </tr> </table> | O | D | I | S | Z | A | P | C | ? |  |  | ? | ? | ? | ? | * |
|                                                                                                                                                                                                                                                                                                                                                                                                                                                                                                                                                                                                                                                                                                                                                                                                                                                                                | O                                                                                                                                                                                                                                                                                                                                                                                                                                                                                                                                                                                                                                                                                                                                                                                                                                                                                                                                                                                                                                                                                                                                             | D | I | S | Z | A | P | C |   |   |  |  |   |   |   |   |   |
| ?                                                                                                                                                                                                                                                                                                                                                                                                                                                                                                                                                                                                                                                                                                                                                                                                                                                                              |                                                                                                                                                                                                                                                                                                                                                                                                                                                                                                                                                                                                                                                                                                                                                                                                                                                                                                                                                                                                                                                                                                                                               |   | ? | ? | ? | ? | * |   |   |   |  |  |   |   |   |   |   |
| <p>Copies a specified bit (<i>n</i>) into the Carry flag. The destination operand contains the value in which the bit is located, and the source operand indicates the bit's position within the destination. BT copies bit <i>n</i> to the Carry flag. BTC copies bit <i>n</i> to the Carry flag and complements bit <i>n</i> in the destination operand. BTR copies bit <i>n</i> to the Carry flag and clears bit <i>n</i> in the destination. BTS copies bit <i>n</i> to the Carry flag and sets bit <i>n</i> in the destination.</p> <p>Instruction formats:</p> <p style="text-align: center;"> <span style="margin-right: 150px;"><b>BT</b> <i>r/m16, imm8</i></span> <span><b>BT</b> <i>r/m16, r16</i></span> </p> <p style="text-align: center;"> <span style="margin-right: 150px;"><b>BT</b> <i>r/m32, imm8</i></span> <span><b>BT</b> <i>r/m32, r32</i></span> </p> |                                                                                                                                                                                                                                                                                                                                                                                                                                                                                                                                                                                                                                                                                                                                                                                                                                                                                                                                                                                                                                                                                                                                               |   |   |   |   |   |   |   |   |   |  |  |   |   |   |   |   |



|                                                                                                                                                                                                                                                                                                                                                                                                                                                                                                                                                                                                                                                                                           |                                                                                                                                                                                                                                                                                                                                                                                                                                                                                                                                                                                                                                                                                                                                                                                                                  |                   |                      |                   |                 |   |   |   |   |  |  |  |  |  |  |  |  |
|-------------------------------------------------------------------------------------------------------------------------------------------------------------------------------------------------------------------------------------------------------------------------------------------------------------------------------------------------------------------------------------------------------------------------------------------------------------------------------------------------------------------------------------------------------------------------------------------------------------------------------------------------------------------------------------------|------------------------------------------------------------------------------------------------------------------------------------------------------------------------------------------------------------------------------------------------------------------------------------------------------------------------------------------------------------------------------------------------------------------------------------------------------------------------------------------------------------------------------------------------------------------------------------------------------------------------------------------------------------------------------------------------------------------------------------------------------------------------------------------------------------------|-------------------|----------------------|-------------------|-----------------|---|---|---|---|--|--|--|--|--|--|--|--|
| <b>CALL</b>                                                                                                                                                                                                                                                                                                                                                                                                                                                                                                                                                                                                                                                                               | <b>Call a Procedure</b> <div style="text-align: center; margin-top: 10px;"> <table style="margin: auto;"> <tr> <td>O</td><td>D</td><td>I</td><td>S</td><td>Z</td><td>A</td><td>P</td><td>C</td> </tr> <tr> <td style="border: 1px solid black; width: 20px; height: 15px;"></td> <td style="border: 1px solid black; width: 20px; height: 15px;"></td> <td style="border: 1px solid black; width: 20px; height: 15px;"></td> <td style="border: 1px solid black; width: 20px; height: 15px;"></td> <td style="border: 1px solid black; width: 20px; height: 15px;"></td> <td style="border: 1px solid black; width: 20px; height: 15px;"></td> <td style="border: 1px solid black; width: 20px; height: 15px;"></td> <td style="border: 1px solid black; width: 20px; height: 15px;"></td> </tr> </table> </div> | O                 | D                    | I                 | S               | Z | A | P | C |  |  |  |  |  |  |  |  |
|                                                                                                                                                                                                                                                                                                                                                                                                                                                                                                                                                                                                                                                                                           | O                                                                                                                                                                                                                                                                                                                                                                                                                                                                                                                                                                                                                                                                                                                                                                                                                | D                 | I                    | S                 | Z               | A | P | C |   |  |  |  |  |  |  |  |  |
|                                                                                                                                                                                                                                                                                                                                                                                                                                                                                                                                                                                                                                                                                           |                                                                                                                                                                                                                                                                                                                                                                                                                                                                                                                                                                                                                                                                                                                                                                                                                  |                   |                      |                   |                 |   |   |   |   |  |  |  |  |  |  |  |  |
| <p>Pushes the location of the next instruction on the stack and transfers to the destination location. If the procedure is near (in the same segment), only the offset of the next instruction is pushed; otherwise, both the segment and the offset are pushed.</p> <p>Instruction formats:</p> <table style="width: 100%; border: none;"> <tr> <td style="padding-left: 40px;"><i>CALL nearlabel</i></td> <td style="padding-left: 150px;"><i>CALL mem16</i></td> </tr> <tr> <td style="padding-left: 40px;"><i>CALL farlabel</i></td> <td style="padding-left: 150px;"><i>CALL mem32</i></td> </tr> <tr> <td style="padding-left: 40px;"><i>CALL reg</i></td> <td></td> </tr> </table> | <i>CALL nearlabel</i>                                                                                                                                                                                                                                                                                                                                                                                                                                                                                                                                                                                                                                                                                                                                                                                            | <i>CALL mem16</i> | <i>CALL farlabel</i> | <i>CALL mem32</i> | <i>CALL reg</i> |   |   |   |   |  |  |  |  |  |  |  |  |
| <i>CALL nearlabel</i>                                                                                                                                                                                                                                                                                                                                                                                                                                                                                                                                                                                                                                                                     | <i>CALL mem16</i>                                                                                                                                                                                                                                                                                                                                                                                                                                                                                                                                                                                                                                                                                                                                                                                                |                   |                      |                   |                 |   |   |   |   |  |  |  |  |  |  |  |  |
| <i>CALL farlabel</i>                                                                                                                                                                                                                                                                                                                                                                                                                                                                                                                                                                                                                                                                      | <i>CALL mem32</i>                                                                                                                                                                                                                                                                                                                                                                                                                                                                                                                                                                                                                                                                                                                                                                                                |                   |                      |                   |                 |   |   |   |   |  |  |  |  |  |  |  |  |
| <i>CALL reg</i>                                                                                                                                                                                                                                                                                                                                                                                                                                                                                                                                                                                                                                                                           |                                                                                                                                                                                                                                                                                                                                                                                                                                                                                                                                                                                                                                                                                                                                                                                                                  |                   |                      |                   |                 |   |   |   |   |  |  |  |  |  |  |  |  |

|                                                                                                                                 |                                                                                                                                                                                                                                                                                                                                                                                                                                                                                                                                                                                                                                                                                                                                                                                                                      |   |   |   |   |   |   |   |   |  |  |  |  |  |  |  |  |
|---------------------------------------------------------------------------------------------------------------------------------|----------------------------------------------------------------------------------------------------------------------------------------------------------------------------------------------------------------------------------------------------------------------------------------------------------------------------------------------------------------------------------------------------------------------------------------------------------------------------------------------------------------------------------------------------------------------------------------------------------------------------------------------------------------------------------------------------------------------------------------------------------------------------------------------------------------------|---|---|---|---|---|---|---|---|--|--|--|--|--|--|--|--|
| <b>CBW</b>                                                                                                                      | <b>Convert Byte to Word</b> <div style="text-align: center; margin-top: 10px;"> <table style="margin: auto;"> <tr> <td>O</td><td>D</td><td>I</td><td>S</td><td>Z</td><td>A</td><td>P</td><td>C</td> </tr> <tr> <td style="border: 1px solid black; width: 20px; height: 15px;"></td> <td style="border: 1px solid black; width: 20px; height: 15px;"></td> <td style="border: 1px solid black; width: 20px; height: 15px;"></td> <td style="border: 1px solid black; width: 20px; height: 15px;"></td> <td style="border: 1px solid black; width: 20px; height: 15px;"></td> <td style="border: 1px solid black; width: 20px; height: 15px;"></td> <td style="border: 1px solid black; width: 20px; height: 15px;"></td> <td style="border: 1px solid black; width: 20px; height: 15px;"></td> </tr> </table> </div> | O | D | I | S | Z | A | P | C |  |  |  |  |  |  |  |  |
|                                                                                                                                 | O                                                                                                                                                                                                                                                                                                                                                                                                                                                                                                                                                                                                                                                                                                                                                                                                                    | D | I | S | Z | A | P | C |   |  |  |  |  |  |  |  |  |
|                                                                                                                                 |                                                                                                                                                                                                                                                                                                                                                                                                                                                                                                                                                                                                                                                                                                                                                                                                                      |   |   |   |   |   |   |   |   |  |  |  |  |  |  |  |  |
| <p>Extends the sign bit in AL throughout the AH register.</p> <p>Instruction format:</p> <p style="text-align: center;">CBW</p> |                                                                                                                                                                                                                                                                                                                                                                                                                                                                                                                                                                                                                                                                                                                                                                                                                      |   |   |   |   |   |   |   |   |  |  |  |  |  |  |  |  |

|                                                                                                                                   |                                                                                                                                                                                                                                                                                                                                                                                                                                                                                                                                                                                                                                                                                                                                                                                                                                      |   |   |   |   |   |   |   |   |  |  |  |  |  |  |  |  |
|-----------------------------------------------------------------------------------------------------------------------------------|--------------------------------------------------------------------------------------------------------------------------------------------------------------------------------------------------------------------------------------------------------------------------------------------------------------------------------------------------------------------------------------------------------------------------------------------------------------------------------------------------------------------------------------------------------------------------------------------------------------------------------------------------------------------------------------------------------------------------------------------------------------------------------------------------------------------------------------|---|---|---|---|---|---|---|---|--|--|--|--|--|--|--|--|
| <b>CDQ</b>                                                                                                                        | <b>Convert Doubleword to Quadword (x86)</b> <div style="text-align: center; margin-top: 10px;"> <table style="margin: auto;"> <tr> <td>O</td><td>D</td><td>I</td><td>S</td><td>Z</td><td>A</td><td>P</td><td>C</td> </tr> <tr> <td style="border: 1px solid black; width: 20px; height: 15px;"></td> <td style="border: 1px solid black; width: 20px; height: 15px;"></td> <td style="border: 1px solid black; width: 20px; height: 15px;"></td> <td style="border: 1px solid black; width: 20px; height: 15px;"></td> <td style="border: 1px solid black; width: 20px; height: 15px;"></td> <td style="border: 1px solid black; width: 20px; height: 15px;"></td> <td style="border: 1px solid black; width: 20px; height: 15px;"></td> <td style="border: 1px solid black; width: 20px; height: 15px;"></td> </tr> </table> </div> | O | D | I | S | Z | A | P | C |  |  |  |  |  |  |  |  |
|                                                                                                                                   | O                                                                                                                                                                                                                                                                                                                                                                                                                                                                                                                                                                                                                                                                                                                                                                                                                                    | D | I | S | Z | A | P | C |   |  |  |  |  |  |  |  |  |
|                                                                                                                                   |                                                                                                                                                                                                                                                                                                                                                                                                                                                                                                                                                                                                                                                                                                                                                                                                                                      |   |   |   |   |   |   |   |   |  |  |  |  |  |  |  |  |
| <p>Extends the sign bit in EAX throughout the EDX register.</p> <p>Instruction format:</p> <p style="text-align: center;">CDQ</p> |                                                                                                                                                                                                                                                                                                                                                                                                                                                                                                                                                                                                                                                                                                                                                                                                                                      |   |   |   |   |   |   |   |   |  |  |  |  |  |  |  |  |

|                                                                                                         |                                                                                                                                                                                                                                                                                                                                                                                                                                                                                                                                                                                                                                                                                                                                                                                                                                       |   |   |   |   |   |   |   |   |  |  |  |  |  |  |  |   |
|---------------------------------------------------------------------------------------------------------|---------------------------------------------------------------------------------------------------------------------------------------------------------------------------------------------------------------------------------------------------------------------------------------------------------------------------------------------------------------------------------------------------------------------------------------------------------------------------------------------------------------------------------------------------------------------------------------------------------------------------------------------------------------------------------------------------------------------------------------------------------------------------------------------------------------------------------------|---|---|---|---|---|---|---|---|--|--|--|--|--|--|--|---|
| <b>CLC</b>                                                                                              | <b>Clear Carry Flag</b> <div style="text-align: center; margin-top: 10px;"> <table style="margin: auto;"> <tr> <td>O</td><td>D</td><td>I</td><td>S</td><td>Z</td><td>A</td><td>P</td><td>C</td> </tr> <tr> <td style="border: 1px solid black; width: 20px; height: 15px;"></td> <td style="border: 1px solid black; width: 20px; height: 15px;"></td> <td style="border: 1px solid black; width: 20px; height: 15px;"></td> <td style="border: 1px solid black; width: 20px; height: 15px;"></td> <td style="border: 1px solid black; width: 20px; height: 15px;"></td> <td style="border: 1px solid black; width: 20px; height: 15px;"></td> <td style="border: 1px solid black; width: 20px; height: 15px;"></td> <td style="border: 1px solid black; width: 20px; height: 15px; text-align: center;">0</td> </tr> </table> </div> | O | D | I | S | Z | A | P | C |  |  |  |  |  |  |  | 0 |
|                                                                                                         | O                                                                                                                                                                                                                                                                                                                                                                                                                                                                                                                                                                                                                                                                                                                                                                                                                                     | D | I | S | Z | A | P | C |   |  |  |  |  |  |  |  |   |
|                                                                                                         |                                                                                                                                                                                                                                                                                                                                                                                                                                                                                                                                                                                                                                                                                                                                                                                                                                       |   |   |   |   |   | 0 |   |   |  |  |  |  |  |  |  |   |
| <p>Clears the Carry flag to zero.</p> <p>Instruction format:</p> <p style="text-align: center;">CLC</p> |                                                                                                                                                                                                                                                                                                                                                                                                                                                                                                                                                                                                                                                                                                                                                                                                                                       |   |   |   |   |   |   |   |   |  |  |  |  |  |  |  |   |

|                                                                                                                                                                                      |                                                                                                                                                                                                                                                                                                                                                                                                                                                                                                                                                                                                                                                                                                                                                                                                                                                                                                                                                                                                                                           |   |   |   |   |   |   |   |   |  |   |  |  |  |  |  |  |
|--------------------------------------------------------------------------------------------------------------------------------------------------------------------------------------|-------------------------------------------------------------------------------------------------------------------------------------------------------------------------------------------------------------------------------------------------------------------------------------------------------------------------------------------------------------------------------------------------------------------------------------------------------------------------------------------------------------------------------------------------------------------------------------------------------------------------------------------------------------------------------------------------------------------------------------------------------------------------------------------------------------------------------------------------------------------------------------------------------------------------------------------------------------------------------------------------------------------------------------------|---|---|---|---|---|---|---|---|--|---|--|--|--|--|--|--|
| <b>CLD</b>                                                                                                                                                                           | <p><b>Clear Direction Flag</b></p> <table style="margin-left: auto; margin-right: auto; border-collapse: collapse;"> <tr> <td style="padding: 0 5px;">O</td><td style="padding: 0 5px;">D</td><td style="padding: 0 5px;">I</td><td style="padding: 0 5px;">S</td><td style="padding: 0 5px;">Z</td><td style="padding: 0 5px;">A</td><td style="padding: 0 5px;">P</td><td style="padding: 0 5px;">C</td> </tr> <tr> <td style="border: 1px solid black; width: 20px; height: 20px;"></td> <td style="border: 1px solid black; width: 20px; height: 20px; text-align: center;">0</td> <td style="border: 1px solid black; width: 20px; height: 20px;"></td> <td style="border: 1px solid black; width: 20px; height: 20px;"></td> <td style="border: 1px solid black; width: 20px; height: 20px;"></td> <td style="border: 1px solid black; width: 20px; height: 20px;"></td> <td style="border: 1px solid black; width: 20px; height: 20px;"></td> <td style="border: 1px solid black; width: 20px; height: 20px;"></td> </tr> </table> | O | D | I | S | Z | A | P | C |  | 0 |  |  |  |  |  |  |
|                                                                                                                                                                                      | O                                                                                                                                                                                                                                                                                                                                                                                                                                                                                                                                                                                                                                                                                                                                                                                                                                                                                                                                                                                                                                         | D | I | S | Z | A | P | C |   |  |   |  |  |  |  |  |  |
|                                                                                                                                                                                      | 0                                                                                                                                                                                                                                                                                                                                                                                                                                                                                                                                                                                                                                                                                                                                                                                                                                                                                                                                                                                                                                         |   |   |   |   |   |   |   |   |  |   |  |  |  |  |  |  |
| <p>Clears the Direction flag to zero. String primitive instructions will automatically increment (E)SI and (E)DI.<br/>Instruction format:</p> <p style="text-align: center;">CLD</p> |                                                                                                                                                                                                                                                                                                                                                                                                                                                                                                                                                                                                                                                                                                                                                                                                                                                                                                                                                                                                                                           |   |   |   |   |   |   |   |   |  |   |  |  |  |  |  |  |

|                                                                                                                                                                                           |                                                                                                                                                                                                                                                                                                                                                                                                                                                                                                                                                                                                                                                                                                                                                                                                                                                                                                                                                                                                                                           |   |   |   |   |   |   |   |   |  |  |   |  |  |  |  |  |
|-------------------------------------------------------------------------------------------------------------------------------------------------------------------------------------------|-------------------------------------------------------------------------------------------------------------------------------------------------------------------------------------------------------------------------------------------------------------------------------------------------------------------------------------------------------------------------------------------------------------------------------------------------------------------------------------------------------------------------------------------------------------------------------------------------------------------------------------------------------------------------------------------------------------------------------------------------------------------------------------------------------------------------------------------------------------------------------------------------------------------------------------------------------------------------------------------------------------------------------------------|---|---|---|---|---|---|---|---|--|--|---|--|--|--|--|--|
| <b>CLI</b>                                                                                                                                                                                | <p><b>Clear Interrupt Flag</b></p> <table style="margin-left: auto; margin-right: auto; border-collapse: collapse;"> <tr> <td style="padding: 0 5px;">O</td><td style="padding: 0 5px;">D</td><td style="padding: 0 5px;">I</td><td style="padding: 0 5px;">S</td><td style="padding: 0 5px;">Z</td><td style="padding: 0 5px;">A</td><td style="padding: 0 5px;">P</td><td style="padding: 0 5px;">C</td> </tr> <tr> <td style="border: 1px solid black; width: 20px; height: 20px;"></td> <td style="border: 1px solid black; width: 20px; height: 20px;"></td> <td style="border: 1px solid black; width: 20px; height: 20px; text-align: center;">0</td> <td style="border: 1px solid black; width: 20px; height: 20px;"></td> <td style="border: 1px solid black; width: 20px; height: 20px;"></td> <td style="border: 1px solid black; width: 20px; height: 20px;"></td> <td style="border: 1px solid black; width: 20px; height: 20px;"></td> <td style="border: 1px solid black; width: 20px; height: 20px;"></td> </tr> </table> | O | D | I | S | Z | A | P | C |  |  | 0 |  |  |  |  |  |
|                                                                                                                                                                                           | O                                                                                                                                                                                                                                                                                                                                                                                                                                                                                                                                                                                                                                                                                                                                                                                                                                                                                                                                                                                                                                         | D | I | S | Z | A | P | C |   |  |  |   |  |  |  |  |  |
|                                                                                                                                                                                           |                                                                                                                                                                                                                                                                                                                                                                                                                                                                                                                                                                                                                                                                                                                                                                                                                                                                                                                                                                                                                                           | 0 |   |   |   |   |   |   |   |  |  |   |  |  |  |  |  |
| <p>Clears the Interrupt flag to zero. This disables maskable hardware interrupts until an STI instruction is executed.<br/>Instruction format:</p> <p style="text-align: center;">CLI</p> |                                                                                                                                                                                                                                                                                                                                                                                                                                                                                                                                                                                                                                                                                                                                                                                                                                                                                                                                                                                                                                           |   |   |   |   |   |   |   |   |  |  |   |  |  |  |  |  |

|                                                                                                                    |                                                                                                                                                                                                                                                                                                                                                                                                                                                                                                                                                                                                                                                                                                                                                                                                                                                                                                                                                                                                                                            |   |   |   |   |   |   |   |   |  |  |  |  |  |  |  |   |
|--------------------------------------------------------------------------------------------------------------------|--------------------------------------------------------------------------------------------------------------------------------------------------------------------------------------------------------------------------------------------------------------------------------------------------------------------------------------------------------------------------------------------------------------------------------------------------------------------------------------------------------------------------------------------------------------------------------------------------------------------------------------------------------------------------------------------------------------------------------------------------------------------------------------------------------------------------------------------------------------------------------------------------------------------------------------------------------------------------------------------------------------------------------------------|---|---|---|---|---|---|---|---|--|--|--|--|--|--|--|---|
| <b>CMC</b>                                                                                                         | <p><b>Complement Carry Flag</b></p> <table style="margin-left: auto; margin-right: auto; border-collapse: collapse;"> <tr> <td style="padding: 0 5px;">O</td><td style="padding: 0 5px;">D</td><td style="padding: 0 5px;">I</td><td style="padding: 0 5px;">S</td><td style="padding: 0 5px;">Z</td><td style="padding: 0 5px;">A</td><td style="padding: 0 5px;">P</td><td style="padding: 0 5px;">C</td> </tr> <tr> <td style="border: 1px solid black; width: 20px; height: 20px;"></td> <td style="border: 1px solid black; width: 20px; height: 20px;"></td> <td style="border: 1px solid black; width: 20px; height: 20px;"></td> <td style="border: 1px solid black; width: 20px; height: 20px;"></td> <td style="border: 1px solid black; width: 20px; height: 20px;"></td> <td style="border: 1px solid black; width: 20px; height: 20px;"></td> <td style="border: 1px solid black; width: 20px; height: 20px;"></td> <td style="border: 1px solid black; width: 20px; height: 20px; text-align: center;">*</td> </tr> </table> | O | D | I | S | Z | A | P | C |  |  |  |  |  |  |  | * |
|                                                                                                                    | O                                                                                                                                                                                                                                                                                                                                                                                                                                                                                                                                                                                                                                                                                                                                                                                                                                                                                                                                                                                                                                          | D | I | S | Z | A | P | C |   |  |  |  |  |  |  |  |   |
|                                                                                                                    |                                                                                                                                                                                                                                                                                                                                                                                                                                                                                                                                                                                                                                                                                                                                                                                                                                                                                                                                                                                                                                            |   |   |   |   |   | * |   |   |  |  |  |  |  |  |  |   |
| <p>Toggles the current value of the Carry flag.<br/>Instruction format:</p> <p style="text-align: center;">CMC</p> |                                                                                                                                                                                                                                                                                                                                                                                                                                                                                                                                                                                                                                                                                                                                                                                                                                                                                                                                                                                                                                            |   |   |   |   |   |   |   |   |  |  |  |  |  |  |  |   |

|                                                                                                                                                                                                                                                                                                                                                                                                                                                                                                                                                                                                 |                                                                                                                                                                                                                                                                                                                                                                                                                                                                                                                                                                                                                                                                                                                                                                                                                                                                                                                                                                                                                                                                                                                                       |                     |                     |                     |                     |                       |   |   |   |   |  |  |   |   |   |   |   |
|-------------------------------------------------------------------------------------------------------------------------------------------------------------------------------------------------------------------------------------------------------------------------------------------------------------------------------------------------------------------------------------------------------------------------------------------------------------------------------------------------------------------------------------------------------------------------------------------------|---------------------------------------------------------------------------------------------------------------------------------------------------------------------------------------------------------------------------------------------------------------------------------------------------------------------------------------------------------------------------------------------------------------------------------------------------------------------------------------------------------------------------------------------------------------------------------------------------------------------------------------------------------------------------------------------------------------------------------------------------------------------------------------------------------------------------------------------------------------------------------------------------------------------------------------------------------------------------------------------------------------------------------------------------------------------------------------------------------------------------------------|---------------------|---------------------|---------------------|---------------------|-----------------------|---|---|---|---|--|--|---|---|---|---|---|
| <b>CMP</b>                                                                                                                                                                                                                                                                                                                                                                                                                                                                                                                                                                                      | <p><b>Compare</b></p> <table style="margin-left: auto; margin-right: auto; border-collapse: collapse;"> <tr> <td style="padding: 0 5px;">O</td><td style="padding: 0 5px;">D</td><td style="padding: 0 5px;">I</td><td style="padding: 0 5px;">S</td><td style="padding: 0 5px;">Z</td><td style="padding: 0 5px;">A</td><td style="padding: 0 5px;">P</td><td style="padding: 0 5px;">C</td> </tr> <tr> <td style="border: 1px solid black; width: 20px; height: 20px; text-align: center;">*</td> <td style="border: 1px solid black; width: 20px; height: 20px;"></td> <td style="border: 1px solid black; width: 20px; height: 20px;"></td> <td style="border: 1px solid black; width: 20px; height: 20px; text-align: center;">*</td> <td style="border: 1px solid black; width: 20px; height: 20px; text-align: center;">*</td> <td style="border: 1px solid black; width: 20px; height: 20px; text-align: center;">*</td> <td style="border: 1px solid black; width: 20px; height: 20px; text-align: center;">*</td> <td style="border: 1px solid black; width: 20px; height: 20px; text-align: center;">*</td> </tr> </table> | O                   | D                   | I                   | S                   | Z                     | A | P | C | * |  |  | * | * | * | * | * |
|                                                                                                                                                                                                                                                                                                                                                                                                                                                                                                                                                                                                 | O                                                                                                                                                                                                                                                                                                                                                                                                                                                                                                                                                                                                                                                                                                                                                                                                                                                                                                                                                                                                                                                                                                                                     | D                   | I                   | S                   | Z                   | A                     | P | C |   |   |  |  |   |   |   |   |   |
| *                                                                                                                                                                                                                                                                                                                                                                                                                                                                                                                                                                                               |                                                                                                                                                                                                                                                                                                                                                                                                                                                                                                                                                                                                                                                                                                                                                                                                                                                                                                                                                                                                                                                                                                                                       |                     | *                   | *                   | *                   | *                     | * |   |   |   |  |  |   |   |   |   |   |
| <p>Compares the destination to the source by performing an implied subtraction of the source from the destination.<br/>Instruction formats:</p> <table style="width: 100%; border: none;"> <tr> <td style="padding-left: 40px;">CMP <i>reg, reg</i></td> <td style="padding-left: 150px;">CMP <i>reg, imm</i></td> </tr> <tr> <td style="padding-left: 40px;">CMP <i>mem, reg</i></td> <td style="padding-left: 150px;">CMP <i>mem, imm</i></td> </tr> <tr> <td style="padding-left: 40px;">CMP <i>reg, mem</i></td> <td style="padding-left: 150px;">CMP <i>accum, imm</i></td> </tr> </table> | CMP <i>reg, reg</i>                                                                                                                                                                                                                                                                                                                                                                                                                                                                                                                                                                                                                                                                                                                                                                                                                                                                                                                                                                                                                                                                                                                   | CMP <i>reg, imm</i> | CMP <i>mem, reg</i> | CMP <i>mem, imm</i> | CMP <i>reg, mem</i> | CMP <i>accum, imm</i> |   |   |   |   |  |  |   |   |   |   |   |
| CMP <i>reg, reg</i>                                                                                                                                                                                                                                                                                                                                                                                                                                                                                                                                                                             | CMP <i>reg, imm</i>                                                                                                                                                                                                                                                                                                                                                                                                                                                                                                                                                                                                                                                                                                                                                                                                                                                                                                                                                                                                                                                                                                                   |                     |                     |                     |                     |                       |   |   |   |   |  |  |   |   |   |   |   |
| CMP <i>mem, reg</i>                                                                                                                                                                                                                                                                                                                                                                                                                                                                                                                                                                             | CMP <i>mem, imm</i>                                                                                                                                                                                                                                                                                                                                                                                                                                                                                                                                                                                                                                                                                                                                                                                                                                                                                                                                                                                                                                                                                                                   |                     |                     |                     |                     |                       |   |   |   |   |  |  |   |   |   |   |   |
| CMP <i>reg, mem</i>                                                                                                                                                                                                                                                                                                                                                                                                                                                                                                                                                                             | CMP <i>accum, imm</i>                                                                                                                                                                                                                                                                                                                                                                                                                                                                                                                                                                                                                                                                                                                                                                                                                                                                                                                                                                                                                                                                                                                 |                     |                     |                     |                     |                       |   |   |   |   |  |  |   |   |   |   |   |

|                                                                                                                                                                                                                                                                                                                                                                                                                                                                                                                                                                                                                                                                                                 |                                                                                                                                                                                                                                                                                                                                                                                                                                                                                                             |   |   |   |   |   |   |   |   |   |  |  |   |   |   |   |   |
|-------------------------------------------------------------------------------------------------------------------------------------------------------------------------------------------------------------------------------------------------------------------------------------------------------------------------------------------------------------------------------------------------------------------------------------------------------------------------------------------------------------------------------------------------------------------------------------------------------------------------------------------------------------------------------------------------|-------------------------------------------------------------------------------------------------------------------------------------------------------------------------------------------------------------------------------------------------------------------------------------------------------------------------------------------------------------------------------------------------------------------------------------------------------------------------------------------------------------|---|---|---|---|---|---|---|---|---|--|--|---|---|---|---|---|
| <b>CMPS,<br/>CMPSB,<br/>CMPSW,<br/>CMPSD</b>                                                                                                                                                                                                                                                                                                                                                                                                                                                                                                                                                                                                                                                    | <b>Compare Strings</b>                                                                                                                                                                                                                                                                                                                                                                                                                                                                                      |   |   |   |   |   |   |   |   |   |  |  |   |   |   |   |   |
|                                                                                                                                                                                                                                                                                                                                                                                                                                                                                                                                                                                                                                                                                                 | <table style="margin: auto;"> <tr> <td>O</td><td>D</td><td>I</td><td>S</td><td>Z</td><td>A</td><td>P</td><td>C</td> </tr> <tr> <td style="border: 1px solid black;">*</td> <td style="border: 1px solid black;"></td> <td style="border: 1px solid black;"></td> <td style="border: 1px solid black;">*</td> <td style="border: 1px solid black;">*</td> <td style="border: 1px solid black;">*</td> <td style="border: 1px solid black;">*</td> <td style="border: 1px solid black;">*</td> </tr> </table> | O | D | I | S | Z | A | P | C | * |  |  | * | * | * | * | * |
|                                                                                                                                                                                                                                                                                                                                                                                                                                                                                                                                                                                                                                                                                                 | O                                                                                                                                                                                                                                                                                                                                                                                                                                                                                                           | D | I | S | Z | A | P | C |   |   |  |  |   |   |   |   |   |
| *                                                                                                                                                                                                                                                                                                                                                                                                                                                                                                                                                                                                                                                                                               |                                                                                                                                                                                                                                                                                                                                                                                                                                                                                                             |   | * | * | * | * | * |   |   |   |  |  |   |   |   |   |   |
| <p>Compares strings in memory addressed by DS:(E)SI and ES:(E)DI. Carries out an implied subtraction of the destination from the source. CMPSB compares bytes, CMPSW compares words, and CMPSD compares doublewords (on x86 processors). (E)SI and (E)DI are increased or decreased according to the operand size and the status of the Direction flag. If the Direction flag is set, (E)SI and (E)DI are decreased; otherwise (E)SI and (E)DI are increased.</p> <p>Instruction formats (formats using explicit operands have intentionally been omitted):</p> <p style="text-align: center;"> <span style="margin-right: 100px;">CMPSB</span> <span>CMPSW</span><br/> <span>CMPSD</span> </p> |                                                                                                                                                                                                                                                                                                                                                                                                                                                                                                             |   |   |   |   |   |   |   |   |   |  |  |   |   |   |   |   |

|                                                                                                                                                                                                                                                                                                                                                                   |                                                                                                                                                                                                                                                                                                                                                                                                                                                                                                             |   |   |   |   |   |   |   |   |   |  |  |   |   |   |   |   |
|-------------------------------------------------------------------------------------------------------------------------------------------------------------------------------------------------------------------------------------------------------------------------------------------------------------------------------------------------------------------|-------------------------------------------------------------------------------------------------------------------------------------------------------------------------------------------------------------------------------------------------------------------------------------------------------------------------------------------------------------------------------------------------------------------------------------------------------------------------------------------------------------|---|---|---|---|---|---|---|---|---|--|--|---|---|---|---|---|
| <b>CMPXCHG</b>                                                                                                                                                                                                                                                                                                                                                    | <b>Compare and Exchange</b>                                                                                                                                                                                                                                                                                                                                                                                                                                                                                 |   |   |   |   |   |   |   |   |   |  |  |   |   |   |   |   |
|                                                                                                                                                                                                                                                                                                                                                                   | <table style="margin: auto;"> <tr> <td>O</td><td>D</td><td>I</td><td>S</td><td>Z</td><td>A</td><td>P</td><td>C</td> </tr> <tr> <td style="border: 1px solid black;">*</td> <td style="border: 1px solid black;"></td> <td style="border: 1px solid black;"></td> <td style="border: 1px solid black;">*</td> <td style="border: 1px solid black;">*</td> <td style="border: 1px solid black;">*</td> <td style="border: 1px solid black;">*</td> <td style="border: 1px solid black;">*</td> </tr> </table> | O | D | I | S | Z | A | P | C | * |  |  | * | * | * | * | * |
|                                                                                                                                                                                                                                                                                                                                                                   | O                                                                                                                                                                                                                                                                                                                                                                                                                                                                                                           | D | I | S | Z | A | P | C |   |   |  |  |   |   |   |   |   |
| *                                                                                                                                                                                                                                                                                                                                                                 |                                                                                                                                                                                                                                                                                                                                                                                                                                                                                                             |   | * | * | * | * | * |   |   |   |  |  |   |   |   |   |   |
| <p>Compares the destination to the accumulator (AL, AX, or EAX). If they are equal, the source is copied to the destination. Otherwise, the destination is copied to the accumulator.</p> <p>Instruction formats:</p> <p style="text-align: center;"> <span style="margin-right: 100px;">CMPXCHG <i>reg, reg</i></span> <span>CMPXCHG <i>mem, reg</i></span> </p> |                                                                                                                                                                                                                                                                                                                                                                                                                                                                                                             |   |   |   |   |   |   |   |   |   |  |  |   |   |   |   |   |

|                                                                                                                           |                                                                                                                                                                                                                                                                                                                                                                                                                                                                                                       |   |   |   |   |   |   |   |   |  |  |  |  |  |  |  |  |
|---------------------------------------------------------------------------------------------------------------------------|-------------------------------------------------------------------------------------------------------------------------------------------------------------------------------------------------------------------------------------------------------------------------------------------------------------------------------------------------------------------------------------------------------------------------------------------------------------------------------------------------------|---|---|---|---|---|---|---|---|--|--|--|--|--|--|--|--|
| <b>CWD</b>                                                                                                                | <b>Convert Word to Doubleword</b>                                                                                                                                                                                                                                                                                                                                                                                                                                                                     |   |   |   |   |   |   |   |   |  |  |  |  |  |  |  |  |
|                                                                                                                           | <table style="margin: auto;"> <tr> <td>O</td><td>D</td><td>I</td><td>S</td><td>Z</td><td>A</td><td>P</td><td>C</td> </tr> <tr> <td style="border: 1px solid black;"></td> <td style="border: 1px solid black;"></td> <td style="border: 1px solid black;"></td> <td style="border: 1px solid black;"></td> <td style="border: 1px solid black;"></td> <td style="border: 1px solid black;"></td> <td style="border: 1px solid black;"></td> <td style="border: 1px solid black;"></td> </tr> </table> | O | D | I | S | Z | A | P | C |  |  |  |  |  |  |  |  |
|                                                                                                                           | O                                                                                                                                                                                                                                                                                                                                                                                                                                                                                                     | D | I | S | Z | A | P | C |   |  |  |  |  |  |  |  |  |
|                                                                                                                           |                                                                                                                                                                                                                                                                                                                                                                                                                                                                                                       |   |   |   |   |   |   |   |   |  |  |  |  |  |  |  |  |
| <p>Extends the sign bit in AX into the DX register.</p> <p>Instruction format:</p> <p style="text-align: center;">CWD</p> |                                                                                                                                                                                                                                                                                                                                                                                                                                                                                                       |   |   |   |   |   |   |   |   |  |  |  |  |  |  |  |  |

|                                                                                                                                                                                              |                                                                                                                                                                                                                                                                                                                                                                                                                                                                                                             |   |   |   |   |   |   |   |   |   |  |  |   |   |   |   |   |
|----------------------------------------------------------------------------------------------------------------------------------------------------------------------------------------------|-------------------------------------------------------------------------------------------------------------------------------------------------------------------------------------------------------------------------------------------------------------------------------------------------------------------------------------------------------------------------------------------------------------------------------------------------------------------------------------------------------------|---|---|---|---|---|---|---|---|---|--|--|---|---|---|---|---|
| <b>DAA</b>                                                                                                                                                                                   | <b>Decimal Adjust After Addition</b>                                                                                                                                                                                                                                                                                                                                                                                                                                                                        |   |   |   |   |   |   |   |   |   |  |  |   |   |   |   |   |
|                                                                                                                                                                                              | <table style="margin: auto;"> <tr> <td>O</td><td>D</td><td>I</td><td>S</td><td>Z</td><td>A</td><td>P</td><td>C</td> </tr> <tr> <td style="border: 1px solid black;">?</td> <td style="border: 1px solid black;"></td> <td style="border: 1px solid black;"></td> <td style="border: 1px solid black;">*</td> <td style="border: 1px solid black;">*</td> <td style="border: 1px solid black;">*</td> <td style="border: 1px solid black;">*</td> <td style="border: 1px solid black;">*</td> </tr> </table> | O | D | I | S | Z | A | P | C | ? |  |  | * | * | * | * | * |
|                                                                                                                                                                                              | O                                                                                                                                                                                                                                                                                                                                                                                                                                                                                                           | D | I | S | Z | A | P | C |   |   |  |  |   |   |   |   |   |
| ?                                                                                                                                                                                            |                                                                                                                                                                                                                                                                                                                                                                                                                                                                                                             |   | * | * | * | * | * |   |   |   |  |  |   |   |   |   |   |
| <p>Adjusts the binary sum in AL after two packed BCD values have been added. Converts the sum to two BCD digits in AL.</p> <p>Instruction format:</p> <p style="text-align: center;">DAA</p> |                                                                                                                                                                                                                                                                                                                                                                                                                                                                                                             |   |   |   |   |   |   |   |   |   |  |  |   |   |   |   |   |

|                                                                                                                                                             |                                                                                                                                                                                                                                                                                                                                                                                                                                                                                                                                                                                                                                                                                                                                                                                                                                                                                                                                                           |   |   |   |   |   |   |   |   |   |  |  |   |   |   |   |   |
|-------------------------------------------------------------------------------------------------------------------------------------------------------------|-----------------------------------------------------------------------------------------------------------------------------------------------------------------------------------------------------------------------------------------------------------------------------------------------------------------------------------------------------------------------------------------------------------------------------------------------------------------------------------------------------------------------------------------------------------------------------------------------------------------------------------------------------------------------------------------------------------------------------------------------------------------------------------------------------------------------------------------------------------------------------------------------------------------------------------------------------------|---|---|---|---|---|---|---|---|---|--|--|---|---|---|---|---|
| <b>DAS</b>                                                                                                                                                  | <p><b>Decimal Adjust After Subtraction</b></p> <table style="margin-left: auto; margin-right: auto; border-collapse: collapse;"> <tr> <td style="padding: 0 5px;">O</td><td style="padding: 0 5px;">D</td><td style="padding: 0 5px;">I</td><td style="padding: 0 5px;">S</td><td style="padding: 0 5px;">Z</td><td style="padding: 0 5px;">A</td><td style="padding: 0 5px;">P</td><td style="padding: 0 5px;">C</td> </tr> <tr> <td style="border: 1px solid black; text-align: center;">?</td><td style="border: 1px solid black; width: 20px;"></td><td style="border: 1px solid black; width: 20px;"></td><td style="border: 1px solid black; text-align: center;">*</td><td style="border: 1px solid black; text-align: center;">*</td><td style="border: 1px solid black; text-align: center;">*</td><td style="border: 1px solid black; text-align: center;">*</td><td style="border: 1px solid black; text-align: center;">*</td> </tr> </table> | O | D | I | S | Z | A | P | C | ? |  |  | * | * | * | * | * |
|                                                                                                                                                             | O                                                                                                                                                                                                                                                                                                                                                                                                                                                                                                                                                                                                                                                                                                                                                                                                                                                                                                                                                         | D | I | S | Z | A | P | C |   |   |  |  |   |   |   |   |   |
| ?                                                                                                                                                           |                                                                                                                                                                                                                                                                                                                                                                                                                                                                                                                                                                                                                                                                                                                                                                                                                                                                                                                                                           |   | * | * | * | * | * |   |   |   |  |  |   |   |   |   |   |
| <p>Converts the binary result of a subtraction operation to two packed BCD digits in AL.<br/>Instruction format:</p> <p style="text-align: center;">DAS</p> |                                                                                                                                                                                                                                                                                                                                                                                                                                                                                                                                                                                                                                                                                                                                                                                                                                                                                                                                                           |   |   |   |   |   |   |   |   |   |  |  |   |   |   |   |   |

|                                                                                                                                                                                                        |                                                                                                                                                                                                                                                                                                                                                                                                                                                                                                                                                                                                                                                                                                                                                                                                                                                                                                                            |   |   |   |   |   |   |   |   |   |  |  |   |   |   |   |  |
|--------------------------------------------------------------------------------------------------------------------------------------------------------------------------------------------------------|----------------------------------------------------------------------------------------------------------------------------------------------------------------------------------------------------------------------------------------------------------------------------------------------------------------------------------------------------------------------------------------------------------------------------------------------------------------------------------------------------------------------------------------------------------------------------------------------------------------------------------------------------------------------------------------------------------------------------------------------------------------------------------------------------------------------------------------------------------------------------------------------------------------------------|---|---|---|---|---|---|---|---|---|--|--|---|---|---|---|--|
| <b>DEC</b>                                                                                                                                                                                             | <p><b>Decrement</b></p> <table style="margin-left: auto; margin-right: auto; border-collapse: collapse;"> <tr> <td style="padding: 0 5px;">O</td><td style="padding: 0 5px;">D</td><td style="padding: 0 5px;">I</td><td style="padding: 0 5px;">S</td><td style="padding: 0 5px;">Z</td><td style="padding: 0 5px;">A</td><td style="padding: 0 5px;">P</td><td style="padding: 0 5px;">C</td> </tr> <tr> <td style="border: 1px solid black; text-align: center;">*</td><td style="border: 1px solid black; width: 20px;"></td><td style="border: 1px solid black; width: 20px;"></td><td style="border: 1px solid black; text-align: center;">*</td><td style="border: 1px solid black; text-align: center;">*</td><td style="border: 1px solid black; text-align: center;">*</td><td style="border: 1px solid black; text-align: center;">*</td><td style="border: 1px solid black; width: 20px;"></td> </tr> </table> | O | D | I | S | Z | A | P | C | * |  |  | * | * | * | * |  |
|                                                                                                                                                                                                        | O                                                                                                                                                                                                                                                                                                                                                                                                                                                                                                                                                                                                                                                                                                                                                                                                                                                                                                                          | D | I | S | Z | A | P | C |   |   |  |  |   |   |   |   |  |
| *                                                                                                                                                                                                      |                                                                                                                                                                                                                                                                                                                                                                                                                                                                                                                                                                                                                                                                                                                                                                                                                                                                                                                            |   | * | * | * | * |   |   |   |   |  |  |   |   |   |   |  |
| <p>Subtracts 1 from an operand. Does not affect the Carry flag.<br/>Instruction formats:</p> <p style="text-align: center;">DEC <i>reg</i> <span style="margin-left: 200px;">DEC <i>mem</i></span></p> |                                                                                                                                                                                                                                                                                                                                                                                                                                                                                                                                                                                                                                                                                                                                                                                                                                                                                                                            |   |   |   |   |   |   |   |   |   |  |  |   |   |   |   |  |

|                                                                                                                                                                                                                                                                                                                                                                                                                                                                                                      |                                                                                                                                                                                                                                                                                                                                                                                                                                                                                                                                                                                                                                                                                                                                                                                                                                                                                                                                                  |   |   |   |   |   |   |   |   |   |  |  |   |   |   |   |   |
|------------------------------------------------------------------------------------------------------------------------------------------------------------------------------------------------------------------------------------------------------------------------------------------------------------------------------------------------------------------------------------------------------------------------------------------------------------------------------------------------------|--------------------------------------------------------------------------------------------------------------------------------------------------------------------------------------------------------------------------------------------------------------------------------------------------------------------------------------------------------------------------------------------------------------------------------------------------------------------------------------------------------------------------------------------------------------------------------------------------------------------------------------------------------------------------------------------------------------------------------------------------------------------------------------------------------------------------------------------------------------------------------------------------------------------------------------------------|---|---|---|---|---|---|---|---|---|--|--|---|---|---|---|---|
| <b>DIV</b>                                                                                                                                                                                                                                                                                                                                                                                                                                                                                           | <p><b>Unsigned Integer Divide</b></p> <table style="margin-left: auto; margin-right: auto; border-collapse: collapse;"> <tr> <td style="padding: 0 5px;">O</td><td style="padding: 0 5px;">D</td><td style="padding: 0 5px;">I</td><td style="padding: 0 5px;">S</td><td style="padding: 0 5px;">Z</td><td style="padding: 0 5px;">A</td><td style="padding: 0 5px;">P</td><td style="padding: 0 5px;">C</td> </tr> <tr> <td style="border: 1px solid black; text-align: center;">?</td><td style="border: 1px solid black; width: 20px;"></td><td style="border: 1px solid black; width: 20px;"></td><td style="border: 1px solid black; text-align: center;">?</td><td style="border: 1px solid black; text-align: center;">?</td><td style="border: 1px solid black; text-align: center;">?</td><td style="border: 1px solid black; text-align: center;">?</td><td style="border: 1px solid black; text-align: center;">?</td> </tr> </table> | O | D | I | S | Z | A | P | C | ? |  |  | ? | ? | ? | ? | ? |
|                                                                                                                                                                                                                                                                                                                                                                                                                                                                                                      | O                                                                                                                                                                                                                                                                                                                                                                                                                                                                                                                                                                                                                                                                                                                                                                                                                                                                                                                                                | D | I | S | Z | A | P | C |   |   |  |  |   |   |   |   |   |
| ?                                                                                                                                                                                                                                                                                                                                                                                                                                                                                                    |                                                                                                                                                                                                                                                                                                                                                                                                                                                                                                                                                                                                                                                                                                                                                                                                                                                                                                                                                  |   | ? | ? | ? | ? | ? |   |   |   |  |  |   |   |   |   |   |
| <p>Performs either 8-, 16-, or 32-bit unsigned integer division. If the divisor is 8 bits, the dividend is AX, the quotient is AL, and the remainder is AH. If the divisor is 16 bits, the dividend is DX:AX, the quotient is AX, and the remainder is DX. If the divisor is 32 bits, the dividend is EDX:EAX, the quotient is EAX, and the remainder is EDX.<br/>Instruction formats:</p> <p style="text-align: center;">DIV <i>reg</i> <span style="margin-left: 200px;">DIV <i>mem</i></span></p> |                                                                                                                                                                                                                                                                                                                                                                                                                                                                                                                                                                                                                                                                                                                                                                                                                                                                                                                                                  |   |   |   |   |   |   |   |   |   |  |  |   |   |   |   |   |

|                                                                                                                                                                                                                                                                                                                                                                                              |                                                                                                                                                                                                                                                                                                                                                                                                                                                                                                                                                                                                                                                                                                                                                                                                                                                                                                   |   |   |   |   |   |   |   |   |  |  |  |  |  |  |  |  |
|----------------------------------------------------------------------------------------------------------------------------------------------------------------------------------------------------------------------------------------------------------------------------------------------------------------------------------------------------------------------------------------------|---------------------------------------------------------------------------------------------------------------------------------------------------------------------------------------------------------------------------------------------------------------------------------------------------------------------------------------------------------------------------------------------------------------------------------------------------------------------------------------------------------------------------------------------------------------------------------------------------------------------------------------------------------------------------------------------------------------------------------------------------------------------------------------------------------------------------------------------------------------------------------------------------|---|---|---|---|---|---|---|---|--|--|--|--|--|--|--|--|
| <b>ENTER</b>                                                                                                                                                                                                                                                                                                                                                                                 | <p><b>Make Stack Frame (80286)</b></p> <table style="margin-left: auto; margin-right: auto; border-collapse: collapse;"> <tr> <td style="padding: 0 5px;">O</td><td style="padding: 0 5px;">D</td><td style="padding: 0 5px;">I</td><td style="padding: 0 5px;">S</td><td style="padding: 0 5px;">Z</td><td style="padding: 0 5px;">A</td><td style="padding: 0 5px;">P</td><td style="padding: 0 5px;">C</td> </tr> <tr> <td style="border: 1px solid black; width: 20px;"></td><td style="border: 1px solid black; width: 20px;"></td><td style="border: 1px solid black; width: 20px;"></td><td style="border: 1px solid black; width: 20px;"></td><td style="border: 1px solid black; width: 20px;"></td><td style="border: 1px solid black; width: 20px;"></td><td style="border: 1px solid black; width: 20px;"></td><td style="border: 1px solid black; width: 20px;"></td> </tr> </table> | O | D | I | S | Z | A | P | C |  |  |  |  |  |  |  |  |
|                                                                                                                                                                                                                                                                                                                                                                                              | O                                                                                                                                                                                                                                                                                                                                                                                                                                                                                                                                                                                                                                                                                                                                                                                                                                                                                                 | D | I | S | Z | A | P | C |   |  |  |  |  |  |  |  |  |
|                                                                                                                                                                                                                                                                                                                                                                                              |                                                                                                                                                                                                                                                                                                                                                                                                                                                                                                                                                                                                                                                                                                                                                                                                                                                                                                   |   |   |   |   |   |   |   |   |  |  |  |  |  |  |  |  |
| <p>Creates a stack frame for a procedure that receives stack parameters and uses local stack variables. The first operand indicates the number of bytes to reserve for local stack variables. The second operand indicates the procedure nesting level (must be set to 0 for C, Basic, and FORTRAN).<br/>Instruction format:</p> <p style="text-align: center;">ENTER <i>imm16, imm8</i></p> |                                                                                                                                                                                                                                                                                                                                                                                                                                                                                                                                                                                                                                                                                                                                                                                                                                                                                                   |   |   |   |   |   |   |   |   |  |  |  |  |  |  |  |  |

|                                                                                                                                                                                                                                        |                                                                                                                                                                                                                                                                                                                                                                                                                                                                                                                                                                                                                                                                                                                                                                                                                                                                                                                                                         |   |   |   |   |   |   |   |   |  |  |  |  |  |  |  |  |
|----------------------------------------------------------------------------------------------------------------------------------------------------------------------------------------------------------------------------------------|---------------------------------------------------------------------------------------------------------------------------------------------------------------------------------------------------------------------------------------------------------------------------------------------------------------------------------------------------------------------------------------------------------------------------------------------------------------------------------------------------------------------------------------------------------------------------------------------------------------------------------------------------------------------------------------------------------------------------------------------------------------------------------------------------------------------------------------------------------------------------------------------------------------------------------------------------------|---|---|---|---|---|---|---|---|--|--|--|--|--|--|--|--|
| <b>HLT</b>                                                                                                                                                                                                                             | <b>Halt</b><br><br><table style="margin: auto;"> <tr> <td style="padding: 0 5px;">O</td> <td style="padding: 0 5px;">D</td> <td style="padding: 0 5px;">I</td> <td style="padding: 0 5px;">S</td> <td style="padding: 0 5px;">Z</td> <td style="padding: 0 5px;">A</td> <td style="padding: 0 5px;">P</td> <td style="padding: 0 5px;">C</td> </tr> <tr> <td style="border: 1px solid black; width: 20px; height: 20px;"></td> <td style="border: 1px solid black; width: 20px; height: 20px;"></td> <td style="border: 1px solid black; width: 20px; height: 20px;"></td> <td style="border: 1px solid black; width: 20px; height: 20px;"></td> <td style="border: 1px solid black; width: 20px; height: 20px;"></td> <td style="border: 1px solid black; width: 20px; height: 20px;"></td> <td style="border: 1px solid black; width: 20px; height: 20px;"></td> <td style="border: 1px solid black; width: 20px; height: 20px;"></td> </tr> </table> | O | D | I | S | Z | A | P | C |  |  |  |  |  |  |  |  |
|                                                                                                                                                                                                                                        | O                                                                                                                                                                                                                                                                                                                                                                                                                                                                                                                                                                                                                                                                                                                                                                                                                                                                                                                                                       | D | I | S | Z | A | P | C |   |  |  |  |  |  |  |  |  |
|                                                                                                                                                                                                                                        |                                                                                                                                                                                                                                                                                                                                                                                                                                                                                                                                                                                                                                                                                                                                                                                                                                                                                                                                                         |   |   |   |   |   |   |   |   |  |  |  |  |  |  |  |  |
| <p>Stops the CPU until a hardware interrupt occurs. (<i>Note:</i> The Interrupt flag must be set with the STI instruction before hardware interrupts can occur.)</p> <p>Instruction format:</p> <p style="text-align: center;">HLT</p> |                                                                                                                                                                                                                                                                                                                                                                                                                                                                                                                                                                                                                                                                                                                                                                                                                                                                                                                                                         |   |   |   |   |   |   |   |   |  |  |  |  |  |  |  |  |

|                                                                                                                                                                                                                                                                                                                                                                                                                                                                                                                                                                                                             |                                                                                                                                                                                                                                                                                                                                                                                                                                                                                                                                                                                                                                                                                                                                                                                                                                                                                                                                                                                                                                                                                                        |   |   |   |   |   |   |   |   |   |  |  |   |   |   |   |   |
|-------------------------------------------------------------------------------------------------------------------------------------------------------------------------------------------------------------------------------------------------------------------------------------------------------------------------------------------------------------------------------------------------------------------------------------------------------------------------------------------------------------------------------------------------------------------------------------------------------------|--------------------------------------------------------------------------------------------------------------------------------------------------------------------------------------------------------------------------------------------------------------------------------------------------------------------------------------------------------------------------------------------------------------------------------------------------------------------------------------------------------------------------------------------------------------------------------------------------------------------------------------------------------------------------------------------------------------------------------------------------------------------------------------------------------------------------------------------------------------------------------------------------------------------------------------------------------------------------------------------------------------------------------------------------------------------------------------------------------|---|---|---|---|---|---|---|---|---|--|--|---|---|---|---|---|
| <b>IDIV</b>                                                                                                                                                                                                                                                                                                                                                                                                                                                                                                                                                                                                 | <b>Signed Integer Divide</b><br><br><table style="margin: auto;"> <tr> <td style="padding: 0 5px;">O</td> <td style="padding: 0 5px;">D</td> <td style="padding: 0 5px;">I</td> <td style="padding: 0 5px;">S</td> <td style="padding: 0 5px;">Z</td> <td style="padding: 0 5px;">A</td> <td style="padding: 0 5px;">P</td> <td style="padding: 0 5px;">C</td> </tr> <tr> <td style="border: 1px solid black; width: 20px; height: 20px; text-align: center;">?</td> <td style="border: 1px solid black; width: 20px; height: 20px;"></td> <td style="border: 1px solid black; width: 20px; height: 20px;"></td> <td style="border: 1px solid black; width: 20px; height: 20px; text-align: center;">?</td> <td style="border: 1px solid black; width: 20px; height: 20px; text-align: center;">?</td> <td style="border: 1px solid black; width: 20px; height: 20px; text-align: center;">?</td> <td style="border: 1px solid black; width: 20px; height: 20px; text-align: center;">?</td> <td style="border: 1px solid black; width: 20px; height: 20px; text-align: center;">?</td> </tr> </table> | O | D | I | S | Z | A | P | C | ? |  |  | ? | ? | ? | ? | ? |
|                                                                                                                                                                                                                                                                                                                                                                                                                                                                                                                                                                                                             | O                                                                                                                                                                                                                                                                                                                                                                                                                                                                                                                                                                                                                                                                                                                                                                                                                                                                                                                                                                                                                                                                                                      | D | I | S | Z | A | P | C |   |   |  |  |   |   |   |   |   |
| ?                                                                                                                                                                                                                                                                                                                                                                                                                                                                                                                                                                                                           |                                                                                                                                                                                                                                                                                                                                                                                                                                                                                                                                                                                                                                                                                                                                                                                                                                                                                                                                                                                                                                                                                                        |   | ? | ? | ? | ? | ? |   |   |   |  |  |   |   |   |   |   |
| <p>Performs a signed integer division operation on EDX:EAX, DX:AX, or AX. If the divisor is 8 bits, the dividend is AX, the quotient is AL, and the remainder is AH. If the divisor is 16 bits, the dividend is DX:AX, the quotient is AX, and the remainder is DX. If the divisor is 32 bits, the dividend is EDX:EAX, the quotient is EAX, and the remainder is EDX. Usually the IDIV operation is prefaced by either CBW or CWD to sign-extend the dividend.</p> <p>Instruction formats:</p> <p style="text-align: center;">IDIV <i>reg</i> <span style="margin-left: 200px;">IDIV <i>mem</i></span></p> |                                                                                                                                                                                                                                                                                                                                                                                                                                                                                                                                                                                                                                                                                                                                                                                                                                                                                                                                                                                                                                                                                                        |   |   |   |   |   |   |   |   |   |  |  |   |   |   |   |   |

|                                                                                                                                                                                                                                                                                                                                                                                                                                                                                                                                                                                                                                                                                                                                                                                                                                                                                                                                                                                                                                                                                                                                                                                                                                                                          |                                                                                                                                                                                                                                                                                                                                                                                                                                                                                                                                                                                                                                                                                                                                                                                                                                                                                                                                                                                                                                                                                                          |   |   |   |   |   |   |   |   |   |  |  |   |   |   |   |   |
|--------------------------------------------------------------------------------------------------------------------------------------------------------------------------------------------------------------------------------------------------------------------------------------------------------------------------------------------------------------------------------------------------------------------------------------------------------------------------------------------------------------------------------------------------------------------------------------------------------------------------------------------------------------------------------------------------------------------------------------------------------------------------------------------------------------------------------------------------------------------------------------------------------------------------------------------------------------------------------------------------------------------------------------------------------------------------------------------------------------------------------------------------------------------------------------------------------------------------------------------------------------------------|----------------------------------------------------------------------------------------------------------------------------------------------------------------------------------------------------------------------------------------------------------------------------------------------------------------------------------------------------------------------------------------------------------------------------------------------------------------------------------------------------------------------------------------------------------------------------------------------------------------------------------------------------------------------------------------------------------------------------------------------------------------------------------------------------------------------------------------------------------------------------------------------------------------------------------------------------------------------------------------------------------------------------------------------------------------------------------------------------------|---|---|---|---|---|---|---|---|---|--|--|---|---|---|---|---|
| <b>IMUL</b>                                                                                                                                                                                                                                                                                                                                                                                                                                                                                                                                                                                                                                                                                                                                                                                                                                                                                                                                                                                                                                                                                                                                                                                                                                                              | <b>Signed Integer Multiply</b><br><br><table style="margin: auto;"> <tr> <td style="padding: 0 5px;">O</td> <td style="padding: 0 5px;">D</td> <td style="padding: 0 5px;">I</td> <td style="padding: 0 5px;">S</td> <td style="padding: 0 5px;">Z</td> <td style="padding: 0 5px;">A</td> <td style="padding: 0 5px;">P</td> <td style="padding: 0 5px;">C</td> </tr> <tr> <td style="border: 1px solid black; width: 20px; height: 20px; text-align: center;">*</td> <td style="border: 1px solid black; width: 20px; height: 20px;"></td> <td style="border: 1px solid black; width: 20px; height: 20px;"></td> <td style="border: 1px solid black; width: 20px; height: 20px; text-align: center;">?</td> <td style="border: 1px solid black; width: 20px; height: 20px; text-align: center;">?</td> <td style="border: 1px solid black; width: 20px; height: 20px; text-align: center;">?</td> <td style="border: 1px solid black; width: 20px; height: 20px; text-align: center;">?</td> <td style="border: 1px solid black; width: 20px; height: 20px; text-align: center;">*</td> </tr> </table> | O | D | I | S | Z | A | P | C | * |  |  | ? | ? | ? | ? | * |
|                                                                                                                                                                                                                                                                                                                                                                                                                                                                                                                                                                                                                                                                                                                                                                                                                                                                                                                                                                                                                                                                                                                                                                                                                                                                          | O                                                                                                                                                                                                                                                                                                                                                                                                                                                                                                                                                                                                                                                                                                                                                                                                                                                                                                                                                                                                                                                                                                        | D | I | S | Z | A | P | C |   |   |  |  |   |   |   |   |   |
| *                                                                                                                                                                                                                                                                                                                                                                                                                                                                                                                                                                                                                                                                                                                                                                                                                                                                                                                                                                                                                                                                                                                                                                                                                                                                        |                                                                                                                                                                                                                                                                                                                                                                                                                                                                                                                                                                                                                                                                                                                                                                                                                                                                                                                                                                                                                                                                                                          |   | ? | ? | ? | ? | * |   |   |   |  |  |   |   |   |   |   |
| <p>Performs a signed integer multiplication on AL, AX, or EAX. If the multiplier is 8 bits, the multiplicand is AL and the product is AX. If the multiplier is 16 bits, the multiplicand is AX and the product is DX:AX. If the multiplier is 32 bits, the multiplicand is EAX and the product is EDX:EAX. The Carry and Overflow flags are set if a 16-bit product extends into AH, or a 32-bit product extends into DX, or a 64-bit product extends into EDX.</p> <p>Instruction formats:</p> <p>Single operand:</p> <p style="text-align: center;">IMUL <i>r/m8</i> <span style="margin-left: 200px;">IMUL <i>r/m16</i></span><br/> IMUL <i>r/m32</i></p> <p>Two operands:</p> <p style="text-align: center;">IMUL <i>r16, r/m16</i> <span style="margin-left: 200px;">IMUL <i>r16, imm8</i></span><br/> IMUL <i>r32, r/m32</i> <span style="margin-left: 200px;">IMUL <i>r32, imm8</i></span><br/> IMUL <i>r16, imm16</i> <span style="margin-left: 200px;">IMUL <i>r32, imm32</i></span></p> <p>Three operands:</p> <p style="text-align: center;">IMUL <i>r16, r/m16, imm8</i> <span style="margin-left: 200px;">IMUL <i>r16, r/m16, imm16</i></span><br/> IMUL <i>r32, r/m32, imm8</i> <span style="margin-left: 200px;">IMUL <i>r32, r/m32, imm32</i></span></p> |                                                                                                                                                                                                                                                                                                                                                                                                                                                                                                                                                                                                                                                                                                                                                                                                                                                                                                                                                                                                                                                                                                          |   |   |   |   |   |   |   |   |   |  |  |   |   |   |   |   |

|                                                                                                                                                                                                                                                                                                                                                                                                    |                                                                                                                                                                                                                                                                                                                                                                                                                                                                                                                                                                                                                                                                                                                                               |  |  |  |  |  |  |  |  |
|----------------------------------------------------------------------------------------------------------------------------------------------------------------------------------------------------------------------------------------------------------------------------------------------------------------------------------------------------------------------------------------------------|-----------------------------------------------------------------------------------------------------------------------------------------------------------------------------------------------------------------------------------------------------------------------------------------------------------------------------------------------------------------------------------------------------------------------------------------------------------------------------------------------------------------------------------------------------------------------------------------------------------------------------------------------------------------------------------------------------------------------------------------------|--|--|--|--|--|--|--|--|
| <b>IN</b>                                                                                                                                                                                                                                                                                                                                                                                          | <p><b>Input From Port</b></p> <p style="text-align: center;">O D I S Z A P C</p> <table style="margin: auto; border-collapse: collapse;"> <tr> <td style="border: 1px solid black; width: 20px; height: 20px;"></td> <td style="border: 1px solid black; width: 20px; height: 20px;"></td> <td style="border: 1px solid black; width: 20px; height: 20px;"></td> <td style="border: 1px solid black; width: 20px; height: 20px;"></td> <td style="border: 1px solid black; width: 20px; height: 20px;"></td> <td style="border: 1px solid black; width: 20px; height: 20px;"></td> <td style="border: 1px solid black; width: 20px; height: 20px;"></td> <td style="border: 1px solid black; width: 20px; height: 20px;"></td> </tr> </table> |  |  |  |  |  |  |  |  |
|                                                                                                                                                                                                                                                                                                                                                                                                    |                                                                                                                                                                                                                                                                                                                                                                                                                                                                                                                                                                                                                                                                                                                                               |  |  |  |  |  |  |  |  |
| <p>Inputs a byte or word from a port into AL or AX. The source operand is a port address, expressed as either an 8-bit constant or a 16-bit address in DX. On x86 processors, a doubleword can be input from a port into EAX.</p> <p>Instruction formats:</p> <p style="text-align: center;"> <span style="margin-right: 100px;"><i>IN accum, imm</i></span> <span><i>IN accum, DX</i></span> </p> |                                                                                                                                                                                                                                                                                                                                                                                                                                                                                                                                                                                                                                                                                                                                               |  |  |  |  |  |  |  |  |

|                                                                                                                                                                                                      |                                                                                                                                                                                                                                                                                                                                                                                                                                                                                                                                                                                                                                                                                                                                                                                                                                                  |   |  |   |   |   |   |   |  |
|------------------------------------------------------------------------------------------------------------------------------------------------------------------------------------------------------|--------------------------------------------------------------------------------------------------------------------------------------------------------------------------------------------------------------------------------------------------------------------------------------------------------------------------------------------------------------------------------------------------------------------------------------------------------------------------------------------------------------------------------------------------------------------------------------------------------------------------------------------------------------------------------------------------------------------------------------------------------------------------------------------------------------------------------------------------|---|--|---|---|---|---|---|--|
| <b>INC</b>                                                                                                                                                                                           | <p><b>Increment</b></p> <p style="text-align: center;">O D I S Z A P C</p> <table style="margin: auto; border-collapse: collapse;"> <tr> <td style="border: 1px solid black; width: 20px; height: 20px; text-align: center;">*</td> <td style="border: 1px solid black; width: 20px; height: 20px;"></td> <td style="border: 1px solid black; width: 20px; height: 20px;"></td> <td style="border: 1px solid black; width: 20px; height: 20px; text-align: center;">*</td> <td style="border: 1px solid black; width: 20px; height: 20px; text-align: center;">*</td> <td style="border: 1px solid black; width: 20px; height: 20px; text-align: center;">*</td> <td style="border: 1px solid black; width: 20px; height: 20px; text-align: center;">*</td> <td style="border: 1px solid black; width: 20px; height: 20px;"></td> </tr> </table> | * |  |   | * | * | * | * |  |
|                                                                                                                                                                                                      | *                                                                                                                                                                                                                                                                                                                                                                                                                                                                                                                                                                                                                                                                                                                                                                                                                                                |   |  | * | * | * | * |   |  |
| <p>Adds 1 to a register or memory operand.</p> <p>Instruction formats:</p> <p style="text-align: center;"> <span style="margin-right: 100px;"><i>INC reg</i></span> <span><i>INC mem</i></span> </p> |                                                                                                                                                                                                                                                                                                                                                                                                                                                                                                                                                                                                                                                                                                                                                                                                                                                  |   |  |   |   |   |   |   |  |

|                                                                                                                                                                                                                                                                                                                                                                                                                                                                                                                                                                                 |                                                                                                                                                                                                                                                                                                                                                                                                                                                                                                                                                                                                                                                                                                                                                                 |  |  |  |  |  |  |  |  |
|---------------------------------------------------------------------------------------------------------------------------------------------------------------------------------------------------------------------------------------------------------------------------------------------------------------------------------------------------------------------------------------------------------------------------------------------------------------------------------------------------------------------------------------------------------------------------------|-----------------------------------------------------------------------------------------------------------------------------------------------------------------------------------------------------------------------------------------------------------------------------------------------------------------------------------------------------------------------------------------------------------------------------------------------------------------------------------------------------------------------------------------------------------------------------------------------------------------------------------------------------------------------------------------------------------------------------------------------------------------|--|--|--|--|--|--|--|--|
| <b>INS,<br/>INSB,<br/>INSW,<br/>INSD</b>                                                                                                                                                                                                                                                                                                                                                                                                                                                                                                                                        | <p><b>Input from Port to String (80286)</b></p> <p style="text-align: center;">O D I S Z A P C</p> <table style="margin: auto; border-collapse: collapse;"> <tr> <td style="border: 1px solid black; width: 20px; height: 20px;"></td> <td style="border: 1px solid black; width: 20px; height: 20px;"></td> <td style="border: 1px solid black; width: 20px; height: 20px;"></td> <td style="border: 1px solid black; width: 20px; height: 20px;"></td> <td style="border: 1px solid black; width: 20px; height: 20px;"></td> <td style="border: 1px solid black; width: 20px; height: 20px;"></td> <td style="border: 1px solid black; width: 20px; height: 20px;"></td> <td style="border: 1px solid black; width: 20px; height: 20px;"></td> </tr> </table> |  |  |  |  |  |  |  |  |
|                                                                                                                                                                                                                                                                                                                                                                                                                                                                                                                                                                                 |                                                                                                                                                                                                                                                                                                                                                                                                                                                                                                                                                                                                                                                                                                                                                                 |  |  |  |  |  |  |  |  |
| <p>Inputs a string pointed to by ES:(E)DI from a port. The port number is specified in DX. For each value received, (E)DI is adjusted in the same way as LODSB and similar string primitive instructions. The REP prefix may be used with this instruction.</p> <p>Instruction formats:</p> <p style="text-align: center;"> <span style="margin-right: 100px;"><i>INS dest, DX</i></span> <span style="margin-right: 100px;"><i>REP INSB dest, DX</i></span><br/> <span style="margin-right: 100px;"><i>REP INSW dest, DX</i></span> <span><i>REP INSD dest, DX</i></span> </p> |                                                                                                                                                                                                                                                                                                                                                                                                                                                                                                                                                                                                                                                                                                                                                                 |  |  |  |  |  |  |  |  |

|                                                                                                                                                                                                                                                                                                                                                                   |                                                                                                                                                                                                                                                                                                                                                                                                                                                                                                                                                                                                                                                                                                                                                              |  |   |   |  |  |  |  |  |
|-------------------------------------------------------------------------------------------------------------------------------------------------------------------------------------------------------------------------------------------------------------------------------------------------------------------------------------------------------------------|--------------------------------------------------------------------------------------------------------------------------------------------------------------------------------------------------------------------------------------------------------------------------------------------------------------------------------------------------------------------------------------------------------------------------------------------------------------------------------------------------------------------------------------------------------------------------------------------------------------------------------------------------------------------------------------------------------------------------------------------------------------|--|---|---|--|--|--|--|--|
| <b>INT</b>                                                                                                                                                                                                                                                                                                                                                        | <p><b>Interrupt</b></p> <p style="text-align: center;">O D I S Z A P C</p> <table style="margin: auto; border-collapse: collapse;"> <tr> <td style="border: 1px solid black; width: 20px; height: 20px;"></td> <td style="border: 1px solid black; width: 20px; height: 20px;"></td> <td style="border: 1px solid black; width: 20px; height: 20px; text-align: center;">0</td> <td style="border: 1px solid black; width: 20px; height: 20px;"></td> <td style="border: 1px solid black; width: 20px; height: 20px;"></td> <td style="border: 1px solid black; width: 20px; height: 20px;"></td> <td style="border: 1px solid black; width: 20px; height: 20px;"></td> <td style="border: 1px solid black; width: 20px; height: 20px;"></td> </tr> </table> |  |   | 0 |  |  |  |  |  |
|                                                                                                                                                                                                                                                                                                                                                                   |                                                                                                                                                                                                                                                                                                                                                                                                                                                                                                                                                                                                                                                                                                                                                              |  | 0 |   |  |  |  |  |  |
| <p>Generates a software interrupt, which in turn calls an operating system subroutine. Clears the Interrupt flag and pushes the flags, CS, and IP on the stack before branching to the interrupt routine.</p> <p>Instruction formats:</p> <p style="text-align: center;"> <span style="margin-right: 100px;"><i>INT imm</i></span> <span><i>INT 3</i></span> </p> |                                                                                                                                                                                                                                                                                                                                                                                                                                                                                                                                                                                                                                                                                                                                                              |  |   |   |  |  |  |  |  |

|             |                                                                                                                                                                                                                                                                                                                                                                                                                                                                                                                                                                                                                                                                                                                                                                                                                                                                                                                                                                                         |   |   |   |   |   |   |   |   |   |   |   |   |   |   |   |
|-------------|-----------------------------------------------------------------------------------------------------------------------------------------------------------------------------------------------------------------------------------------------------------------------------------------------------------------------------------------------------------------------------------------------------------------------------------------------------------------------------------------------------------------------------------------------------------------------------------------------------------------------------------------------------------------------------------------------------------------------------------------------------------------------------------------------------------------------------------------------------------------------------------------------------------------------------------------------------------------------------------------|---|---|---|---|---|---|---|---|---|---|---|---|---|---|---|
| <b>INTO</b> | <b>Interrupt on Overflow</b>                                                                                                                                                                                                                                                                                                                                                                                                                                                                                                                                                                                                                                                                                                                                                                                                                                                                                                                                                            |   |   |   |   |   |   |   |   |   |   |   |   |   |   |   |
|             | <table style="margin-left: auto; margin-right: auto;"> <tr> <td style="text-align: center;">O</td> <td style="text-align: center;">D</td> <td style="text-align: center;">I</td> <td style="text-align: center;">S</td> <td style="text-align: center;">Z</td> <td style="text-align: center;">A</td> <td style="text-align: center;">P</td> <td style="text-align: center;">C</td> </tr> <tr> <td style="text-align: center;">□</td> <td style="text-align: center;">□</td> <td style="text-align: center;">*</td> <td style="text-align: center;">*</td> <td style="text-align: center;">□</td> <td style="text-align: center;">□</td> <td style="text-align: center;">□</td> <td style="text-align: center;">□</td> </tr> </table> <p>Generates internal CPU Interrupt 4 if the Overflow flag is set. No action is taken by MS-DOS if INT 4 is called, but a user-written routine may be substituted instead.</p> <p>Instruction format:</p> <p style="text-align: center;">INTO</p> | O | D | I | S | Z | A | P | C | □ | □ | * | * | □ | □ | □ |
| O           | D                                                                                                                                                                                                                                                                                                                                                                                                                                                                                                                                                                                                                                                                                                                                                                                                                                                                                                                                                                                       | I | S | Z | A | P | C |   |   |   |   |   |   |   |   |   |
| □           | □                                                                                                                                                                                                                                                                                                                                                                                                                                                                                                                                                                                                                                                                                                                                                                                                                                                                                                                                                                                       | * | * | □ | □ | □ | □ |   |   |   |   |   |   |   |   |   |

|             |                                                                                                                                                                                                                                                                                                                                                                                                                                                                                                                                                                                                                                                                                                                                                                                                                                                                                                           |   |   |   |   |   |   |   |   |   |   |   |   |   |   |   |
|-------------|-----------------------------------------------------------------------------------------------------------------------------------------------------------------------------------------------------------------------------------------------------------------------------------------------------------------------------------------------------------------------------------------------------------------------------------------------------------------------------------------------------------------------------------------------------------------------------------------------------------------------------------------------------------------------------------------------------------------------------------------------------------------------------------------------------------------------------------------------------------------------------------------------------------|---|---|---|---|---|---|---|---|---|---|---|---|---|---|---|
| <b>IRET</b> | <b>Interrupt Return</b>                                                                                                                                                                                                                                                                                                                                                                                                                                                                                                                                                                                                                                                                                                                                                                                                                                                                                   |   |   |   |   |   |   |   |   |   |   |   |   |   |   |   |
|             | <table style="margin-left: auto; margin-right: auto;"> <tr> <td style="text-align: center;">O</td> <td style="text-align: center;">D</td> <td style="text-align: center;">I</td> <td style="text-align: center;">S</td> <td style="text-align: center;">Z</td> <td style="text-align: center;">A</td> <td style="text-align: center;">P</td> <td style="text-align: center;">C</td> </tr> <tr> <td style="text-align: center;">*</td> <td style="text-align: center;">*</td> <td style="text-align: center;">*</td> <td style="text-align: center;">*</td> <td style="text-align: center;">*</td> <td style="text-align: center;">*</td> <td style="text-align: center;">*</td> <td style="text-align: center;">*</td> </tr> </table> <p>Returns from an interrupt handling routine. Pops the stack into (E)IP, CS, and the flags.</p> <p>Instruction format:</p> <p style="text-align: center;">IRET</p> | O | D | I | S | Z | A | P | C | * | * | * | * | * | * | * |
| O           | D                                                                                                                                                                                                                                                                                                                                                                                                                                                                                                                                                                                                                                                                                                                                                                                                                                                                                                         | I | S | Z | A | P | C |   |   |   |   |   |   |   |   |   |
| *           | *                                                                                                                                                                                                                                                                                                                                                                                                                                                                                                                                                                                                                                                                                                                                                                                                                                                                                                         | * | * | * | * | * | * |   |   |   |   |   |   |   |   |   |

|                   |                                                                                                                                                                                                                                                                                                                                                                                                                                                                                                                                                                                                                                                                                                                                                                                                                                                                                                                                                                                                                                                                                                                                                  |   |   |   |   |   |   |   |   |   |   |   |   |   |   |   |
|-------------------|--------------------------------------------------------------------------------------------------------------------------------------------------------------------------------------------------------------------------------------------------------------------------------------------------------------------------------------------------------------------------------------------------------------------------------------------------------------------------------------------------------------------------------------------------------------------------------------------------------------------------------------------------------------------------------------------------------------------------------------------------------------------------------------------------------------------------------------------------------------------------------------------------------------------------------------------------------------------------------------------------------------------------------------------------------------------------------------------------------------------------------------------------|---|---|---|---|---|---|---|---|---|---|---|---|---|---|---|
| <b>Jcondition</b> | <b>Conditional Jump</b>                                                                                                                                                                                                                                                                                                                                                                                                                                                                                                                                                                                                                                                                                                                                                                                                                                                                                                                                                                                                                                                                                                                          |   |   |   |   |   |   |   |   |   |   |   |   |   |   |   |
|                   | <table style="margin-left: auto; margin-right: auto;"> <tr> <td style="text-align: center;">O</td> <td style="text-align: center;">D</td> <td style="text-align: center;">I</td> <td style="text-align: center;">S</td> <td style="text-align: center;">Z</td> <td style="text-align: center;">A</td> <td style="text-align: center;">P</td> <td style="text-align: center;">C</td> </tr> <tr> <td style="text-align: center;">□</td> <td style="text-align: center;">□</td> <td style="text-align: center;">□</td> <td style="text-align: center;">□</td> <td style="text-align: center;">□</td> <td style="text-align: center;">□</td> <td style="text-align: center;">□</td> <td style="text-align: center;">□</td> </tr> </table> <p>Jumps to a label if a specified flag condition is true. When using a processor earlier than the x86, the label must be in the range of -128 to +127 bytes from the current location. On x86 processors, the label's offset can be a positive or negative 32-bit value. See Table B-2 for a list of mnemonics.</p> <p>Instruction format:</p> <p style="text-align: center;"><i>Jcondition label</i></p> | O | D | I | S | Z | A | P | C | □ | □ | □ | □ | □ | □ | □ |
| O                 | D                                                                                                                                                                                                                                                                                                                                                                                                                                                                                                                                                                                                                                                                                                                                                                                                                                                                                                                                                                                                                                                                                                                                                | I | S | Z | A | P | C |   |   |   |   |   |   |   |   |   |
| □                 | □                                                                                                                                                                                                                                                                                                                                                                                                                                                                                                                                                                                                                                                                                                                                                                                                                                                                                                                                                                                                                                                                                                                                                | □ | □ | □ | □ | □ | □ |   |   |   |   |   |   |   |   |   |

Table B-2 Conditional Jump Mnemonics.

| Mnemonic | Comment                    | Mnemonic | Comment           |
|----------|----------------------------|----------|-------------------|
| JA       | Jump if above              | JE       | Jump if equal     |
| JNA      | Jump if not above          | JNE      | Jump if not equal |
| JAE      | Jump if above or equal     | JZ       | Jump if zero      |
| JNAE     | Jump if not above or equal | JNZ      | Jump if not zero  |
| JB       | Jump if below              | JS       | Jump if sign      |





|                                                                                                                                                                        |                                                                                                                                                                                                                                                                                                                                                                                                                                                                                                                                                                                                                                                                                                                                                                                                     |   |   |   |   |   |   |   |   |  |  |  |  |  |  |  |  |
|------------------------------------------------------------------------------------------------------------------------------------------------------------------------|-----------------------------------------------------------------------------------------------------------------------------------------------------------------------------------------------------------------------------------------------------------------------------------------------------------------------------------------------------------------------------------------------------------------------------------------------------------------------------------------------------------------------------------------------------------------------------------------------------------------------------------------------------------------------------------------------------------------------------------------------------------------------------------------------------|---|---|---|---|---|---|---|---|--|--|--|--|--|--|--|--|
| <b>LAHF</b>                                                                                                                                                            | <b>Load AH from Flags</b><br><div style="text-align: center;"> <table style="margin: auto;"> <tr> <td>O</td><td>D</td><td>I</td><td>S</td><td>Z</td><td>A</td><td>P</td><td>C</td> </tr> <tr> <td style="border: 1px solid black; width: 20px; height: 15px;"></td> <td style="border: 1px solid black; width: 20px; height: 15px;"></td> <td style="border: 1px solid black; width: 20px; height: 15px;"></td> <td style="border: 1px solid black; width: 20px; height: 15px;"></td> <td style="border: 1px solid black; width: 20px; height: 15px;"></td> <td style="border: 1px solid black; width: 20px; height: 15px;"></td> <td style="border: 1px solid black; width: 20px; height: 15px;"></td> <td style="border: 1px solid black; width: 20px; height: 15px;"></td> </tr> </table> </div> | O | D | I | S | Z | A | P | C |  |  |  |  |  |  |  |  |
|                                                                                                                                                                        | O                                                                                                                                                                                                                                                                                                                                                                                                                                                                                                                                                                                                                                                                                                                                                                                                   | D | I | S | Z | A | P | C |   |  |  |  |  |  |  |  |  |
|                                                                                                                                                                        |                                                                                                                                                                                                                                                                                                                                                                                                                                                                                                                                                                                                                                                                                                                                                                                                     |   |   |   |   |   |   |   |   |  |  |  |  |  |  |  |  |
| <p>The following flags are copied to AH: Sign, Zero, Auxiliary Carry, Parity, and Carry.</p> <p>Instruction format:</p> <p style="text-align: center;"><b>LAHF</b></p> |                                                                                                                                                                                                                                                                                                                                                                                                                                                                                                                                                                                                                                                                                                                                                                                                     |   |   |   |   |   |   |   |   |  |  |  |  |  |  |  |  |

|                                                                                                                                                                                                                                                                                                                                                                                                             |                                                                                                                                                                                                                                                                                                                                                                                                                                                                                                                                                                                                                                                                                                                                                                                                   |   |   |   |   |   |   |   |   |  |  |  |  |  |  |  |  |
|-------------------------------------------------------------------------------------------------------------------------------------------------------------------------------------------------------------------------------------------------------------------------------------------------------------------------------------------------------------------------------------------------------------|---------------------------------------------------------------------------------------------------------------------------------------------------------------------------------------------------------------------------------------------------------------------------------------------------------------------------------------------------------------------------------------------------------------------------------------------------------------------------------------------------------------------------------------------------------------------------------------------------------------------------------------------------------------------------------------------------------------------------------------------------------------------------------------------------|---|---|---|---|---|---|---|---|--|--|--|--|--|--|--|--|
| <b>LDS,<br/>LES,<br/>LFS,<br/>LGS,<br/>LSS</b>                                                                                                                                                                                                                                                                                                                                                              | <b>Load Far Pointer</b><br><div style="text-align: center;"> <table style="margin: auto;"> <tr> <td>O</td><td>D</td><td>I</td><td>S</td><td>Z</td><td>A</td><td>P</td><td>C</td> </tr> <tr> <td style="border: 1px solid black; width: 20px; height: 15px;"></td> <td style="border: 1px solid black; width: 20px; height: 15px;"></td> <td style="border: 1px solid black; width: 20px; height: 15px;"></td> <td style="border: 1px solid black; width: 20px; height: 15px;"></td> <td style="border: 1px solid black; width: 20px; height: 15px;"></td> <td style="border: 1px solid black; width: 20px; height: 15px;"></td> <td style="border: 1px solid black; width: 20px; height: 15px;"></td> <td style="border: 1px solid black; width: 20px; height: 15px;"></td> </tr> </table> </div> | O | D | I | S | Z | A | P | C |  |  |  |  |  |  |  |  |
|                                                                                                                                                                                                                                                                                                                                                                                                             | O                                                                                                                                                                                                                                                                                                                                                                                                                                                                                                                                                                                                                                                                                                                                                                                                 | D | I | S | Z | A | P | C |   |  |  |  |  |  |  |  |  |
|                                                                                                                                                                                                                                                                                                                                                                                                             |                                                                                                                                                                                                                                                                                                                                                                                                                                                                                                                                                                                                                                                                                                                                                                                                   |   |   |   |   |   |   |   |   |  |  |  |  |  |  |  |  |
| <p>Loads the contents of a doubleword memory operand into a segment register and the specified destination register. When using processors prior to the x86, LDS loads into DS, LES loads into ES. On the x86, LFS loads into FS, LGS loads into GS, and LSS loads into SS.</p> <p>Instruction format (same for LDS, LES, LFS, LGS, LSS):</p> <p style="text-align: center;"><b>LDS</b> <i>reg, mem</i></p> |                                                                                                                                                                                                                                                                                                                                                                                                                                                                                                                                                                                                                                                                                                                                                                                                   |   |   |   |   |   |   |   |   |  |  |  |  |  |  |  |  |

|                                                                                                                                                                                                                                                                                   |                                                                                                                                                                                                                                                                                                                                                                                                                                                                                                                                                                                                                                                                                                                                                                                                         |   |   |   |   |   |   |   |   |  |  |  |  |  |  |  |  |
|-----------------------------------------------------------------------------------------------------------------------------------------------------------------------------------------------------------------------------------------------------------------------------------|---------------------------------------------------------------------------------------------------------------------------------------------------------------------------------------------------------------------------------------------------------------------------------------------------------------------------------------------------------------------------------------------------------------------------------------------------------------------------------------------------------------------------------------------------------------------------------------------------------------------------------------------------------------------------------------------------------------------------------------------------------------------------------------------------------|---|---|---|---|---|---|---|---|--|--|--|--|--|--|--|--|
| <b>LEA</b>                                                                                                                                                                                                                                                                        | <b>Load Effective Address</b><br><div style="text-align: center;"> <table style="margin: auto;"> <tr> <td>O</td><td>D</td><td>I</td><td>S</td><td>Z</td><td>A</td><td>P</td><td>C</td> </tr> <tr> <td style="border: 1px solid black; width: 20px; height: 15px;"></td> <td style="border: 1px solid black; width: 20px; height: 15px;"></td> <td style="border: 1px solid black; width: 20px; height: 15px;"></td> <td style="border: 1px solid black; width: 20px; height: 15px;"></td> <td style="border: 1px solid black; width: 20px; height: 15px;"></td> <td style="border: 1px solid black; width: 20px; height: 15px;"></td> <td style="border: 1px solid black; width: 20px; height: 15px;"></td> <td style="border: 1px solid black; width: 20px; height: 15px;"></td> </tr> </table> </div> | O | D | I | S | Z | A | P | C |  |  |  |  |  |  |  |  |
|                                                                                                                                                                                                                                                                                   | O                                                                                                                                                                                                                                                                                                                                                                                                                                                                                                                                                                                                                                                                                                                                                                                                       | D | I | S | Z | A | P | C |   |  |  |  |  |  |  |  |  |
|                                                                                                                                                                                                                                                                                   |                                                                                                                                                                                                                                                                                                                                                                                                                                                                                                                                                                                                                                                                                                                                                                                                         |   |   |   |   |   |   |   |   |  |  |  |  |  |  |  |  |
| <p>Calculates and loads the 16-bit or 32-bit effective address of a memory operand. Similar to MOV.OFFSET, except that only LEA can obtain an address that is calculated at runtime.</p> <p>Instruction format:</p> <p style="text-align: center;"><b>LEA</b> <i>reg, mem</i></p> |                                                                                                                                                                                                                                                                                                                                                                                                                                                                                                                                                                                                                                                                                                                                                                                                         |   |   |   |   |   |   |   |   |  |  |  |  |  |  |  |  |

|                                                                                                                                                                                                                                                                       |                                                                                                                                                                                                                                                                                                                                                                                                                                                                                                                                                                                                                                                                                                                                                                                                            |   |   |   |   |   |   |   |   |  |  |  |  |  |  |  |  |
|-----------------------------------------------------------------------------------------------------------------------------------------------------------------------------------------------------------------------------------------------------------------------|------------------------------------------------------------------------------------------------------------------------------------------------------------------------------------------------------------------------------------------------------------------------------------------------------------------------------------------------------------------------------------------------------------------------------------------------------------------------------------------------------------------------------------------------------------------------------------------------------------------------------------------------------------------------------------------------------------------------------------------------------------------------------------------------------------|---|---|---|---|---|---|---|---|--|--|--|--|--|--|--|--|
| <b>LEAVE</b>                                                                                                                                                                                                                                                          | <b>High-Level Procedure Exit</b><br><div style="text-align: center;"> <table style="margin: auto;"> <tr> <td>O</td><td>D</td><td>I</td><td>S</td><td>Z</td><td>A</td><td>P</td><td>C</td> </tr> <tr> <td style="border: 1px solid black; width: 20px; height: 15px;"></td> <td style="border: 1px solid black; width: 20px; height: 15px;"></td> <td style="border: 1px solid black; width: 20px; height: 15px;"></td> <td style="border: 1px solid black; width: 20px; height: 15px;"></td> <td style="border: 1px solid black; width: 20px; height: 15px;"></td> <td style="border: 1px solid black; width: 20px; height: 15px;"></td> <td style="border: 1px solid black; width: 20px; height: 15px;"></td> <td style="border: 1px solid black; width: 20px; height: 15px;"></td> </tr> </table> </div> | O | D | I | S | Z | A | P | C |  |  |  |  |  |  |  |  |
|                                                                                                                                                                                                                                                                       | O                                                                                                                                                                                                                                                                                                                                                                                                                                                                                                                                                                                                                                                                                                                                                                                                          | D | I | S | Z | A | P | C |   |  |  |  |  |  |  |  |  |
|                                                                                                                                                                                                                                                                       |                                                                                                                                                                                                                                                                                                                                                                                                                                                                                                                                                                                                                                                                                                                                                                                                            |   |   |   |   |   |   |   |   |  |  |  |  |  |  |  |  |
| <p>Terminates the stack frame of a procedure. This reverses the action of the ENTER instruction at the beginning of a procedure by restoring (E)SP and (E)BP to their original values.</p> <p>Instruction format:</p> <p style="text-align: center;"><b>LEAVE</b></p> |                                                                                                                                                                                                                                                                                                                                                                                                                                                                                                                                                                                                                                                                                                                                                                                                            |   |   |   |   |   |   |   |   |  |  |  |  |  |  |  |  |

|                                                                                                                                                                                                                                                                                               |                                                                                                                                                                                                                                                                                                                                                                                                                                                                                                                                                                                                                                                                                                                                                                                                          |   |   |   |   |   |   |   |   |  |  |  |  |  |  |  |  |
|-----------------------------------------------------------------------------------------------------------------------------------------------------------------------------------------------------------------------------------------------------------------------------------------------|----------------------------------------------------------------------------------------------------------------------------------------------------------------------------------------------------------------------------------------------------------------------------------------------------------------------------------------------------------------------------------------------------------------------------------------------------------------------------------------------------------------------------------------------------------------------------------------------------------------------------------------------------------------------------------------------------------------------------------------------------------------------------------------------------------|---|---|---|---|---|---|---|---|--|--|--|--|--|--|--|--|
| <b>LOCK</b>                                                                                                                                                                                                                                                                                   | <p><b>Lock the System Bus</b></p> <div style="text-align: center;"> <table style="margin: auto;"> <tr> <td>O</td><td>D</td><td>I</td><td>S</td><td>Z</td><td>A</td><td>P</td><td>C</td> </tr> <tr> <td style="border: 1px solid black; width: 20px; height: 15px;"></td> <td style="border: 1px solid black; width: 20px; height: 15px;"></td> <td style="border: 1px solid black; width: 20px; height: 15px;"></td> <td style="border: 1px solid black; width: 20px; height: 15px;"></td> <td style="border: 1px solid black; width: 20px; height: 15px;"></td> <td style="border: 1px solid black; width: 20px; height: 15px;"></td> <td style="border: 1px solid black; width: 20px; height: 15px;"></td> <td style="border: 1px solid black; width: 20px; height: 15px;"></td> </tr> </table> </div> | O | D | I | S | Z | A | P | C |  |  |  |  |  |  |  |  |
|                                                                                                                                                                                                                                                                                               | O                                                                                                                                                                                                                                                                                                                                                                                                                                                                                                                                                                                                                                                                                                                                                                                                        | D | I | S | Z | A | P | C |   |  |  |  |  |  |  |  |  |
|                                                                                                                                                                                                                                                                                               |                                                                                                                                                                                                                                                                                                                                                                                                                                                                                                                                                                                                                                                                                                                                                                                                          |   |   |   |   |   |   |   |   |  |  |  |  |  |  |  |  |
| <p>Prevents other processors from executing during the next instruction. This instruction is used when another processor might modify a memory operand that is currently being accessed by the CPU.</p> <p>Instruction format:</p> <p style="text-align: center;"><i>LOCK instruction</i></p> |                                                                                                                                                                                                                                                                                                                                                                                                                                                                                                                                                                                                                                                                                                                                                                                                          |   |   |   |   |   |   |   |   |  |  |  |  |  |  |  |  |

|                                                                                                                                                                                                                                                                                                                                                                                                                                                                                                                                                                                                                                                                                                                                                                                                                                     |                                                                                                                                                                                                                                                                                                                                                                                                                                                                                                                                                                                                                                                                                                                                                                                                                   |       |                        |       |      |   |   |   |   |  |  |  |  |  |  |  |  |
|-------------------------------------------------------------------------------------------------------------------------------------------------------------------------------------------------------------------------------------------------------------------------------------------------------------------------------------------------------------------------------------------------------------------------------------------------------------------------------------------------------------------------------------------------------------------------------------------------------------------------------------------------------------------------------------------------------------------------------------------------------------------------------------------------------------------------------------|-------------------------------------------------------------------------------------------------------------------------------------------------------------------------------------------------------------------------------------------------------------------------------------------------------------------------------------------------------------------------------------------------------------------------------------------------------------------------------------------------------------------------------------------------------------------------------------------------------------------------------------------------------------------------------------------------------------------------------------------------------------------------------------------------------------------|-------|------------------------|-------|------|---|---|---|---|--|--|--|--|--|--|--|--|
| <b>LODS,<br/>LODSB,<br/>LODSW,<br/>LODSD</b>                                                                                                                                                                                                                                                                                                                                                                                                                                                                                                                                                                                                                                                                                                                                                                                        | <p><b>Load Accumulator from String</b></p> <div style="text-align: center;"> <table style="margin: auto;"> <tr> <td>O</td><td>D</td><td>I</td><td>S</td><td>Z</td><td>A</td><td>P</td><td>C</td> </tr> <tr> <td style="border: 1px solid black; width: 20px; height: 15px;"></td> <td style="border: 1px solid black; width: 20px; height: 15px;"></td> <td style="border: 1px solid black; width: 20px; height: 15px;"></td> <td style="border: 1px solid black; width: 20px; height: 15px;"></td> <td style="border: 1px solid black; width: 20px; height: 15px;"></td> <td style="border: 1px solid black; width: 20px; height: 15px;"></td> <td style="border: 1px solid black; width: 20px; height: 15px;"></td> <td style="border: 1px solid black; width: 20px; height: 15px;"></td> </tr> </table> </div> | O     | D                      | I     | S    | Z | A | P | C |  |  |  |  |  |  |  |  |
|                                                                                                                                                                                                                                                                                                                                                                                                                                                                                                                                                                                                                                                                                                                                                                                                                                     | O                                                                                                                                                                                                                                                                                                                                                                                                                                                                                                                                                                                                                                                                                                                                                                                                                 | D     | I                      | S     | Z    | A | P | C |   |  |  |  |  |  |  |  |  |
|                                                                                                                                                                                                                                                                                                                                                                                                                                                                                                                                                                                                                                                                                                                                                                                                                                     |                                                                                                                                                                                                                                                                                                                                                                                                                                                                                                                                                                                                                                                                                                                                                                                                                   |       |                        |       |      |   |   |   |   |  |  |  |  |  |  |  |  |
| <p>Loads a memory byte or word addressed by DS:(E)SI into the accumulator (AL, AX, or EAX). If LODS is used, the memory operand must be specified. LODSB loads a byte into AL, LODSW loads a word into AX, and LODSD on the x86 loads a doubleword into EAX. (E)SI is increased or decreased according to the operand size and the status of the direction flag. If the Direction flag (DF) = 1, (E)SI is decreased; if DF = 0, (E)SI is increased.</p> <p>Instruction formats:</p> <table style="width: 100%; border: none;"> <tr> <td style="text-align: center;">LODS <i>mem</i></td> <td style="text-align: center;">LODSB</td> </tr> <tr> <td style="text-align: center;">LODS <i>segreg:mem</i></td> <td style="text-align: center;">LODSW</td> </tr> <tr> <td style="text-align: center;">LODS</td> <td></td> </tr> </table> | LODS <i>mem</i>                                                                                                                                                                                                                                                                                                                                                                                                                                                                                                                                                                                                                                                                                                                                                                                                   | LODSB | LODS <i>segreg:mem</i> | LODSW | LODS |   |   |   |   |  |  |  |  |  |  |  |  |
| LODS <i>mem</i>                                                                                                                                                                                                                                                                                                                                                                                                                                                                                                                                                                                                                                                                                                                                                                                                                     | LODSB                                                                                                                                                                                                                                                                                                                                                                                                                                                                                                                                                                                                                                                                                                                                                                                                             |       |                        |       |      |   |   |   |   |  |  |  |  |  |  |  |  |
| LODS <i>segreg:mem</i>                                                                                                                                                                                                                                                                                                                                                                                                                                                                                                                                                                                                                                                                                                                                                                                                              | LODSW                                                                                                                                                                                                                                                                                                                                                                                                                                                                                                                                                                                                                                                                                                                                                                                                             |       |                        |       |      |   |   |   |   |  |  |  |  |  |  |  |  |
| LODS                                                                                                                                                                                                                                                                                                                                                                                                                                                                                                                                                                                                                                                                                                                                                                                                                                |                                                                                                                                                                                                                                                                                                                                                                                                                                                                                                                                                                                                                                                                                                                                                                                                                   |       |                        |       |      |   |   |   |   |  |  |  |  |  |  |  |  |

|                                                                                                                                                                                                                                                                                                                                                                         |                                                                                                                                                                                                                                                                                                                                                                                                                                                                                                                                                                                                                                                                                                                                                                                           |                         |   |   |   |   |   |   |   |  |  |  |  |  |  |  |  |
|-------------------------------------------------------------------------------------------------------------------------------------------------------------------------------------------------------------------------------------------------------------------------------------------------------------------------------------------------------------------------|-------------------------------------------------------------------------------------------------------------------------------------------------------------------------------------------------------------------------------------------------------------------------------------------------------------------------------------------------------------------------------------------------------------------------------------------------------------------------------------------------------------------------------------------------------------------------------------------------------------------------------------------------------------------------------------------------------------------------------------------------------------------------------------------|-------------------------|---|---|---|---|---|---|---|--|--|--|--|--|--|--|--|
| <b>LOOP</b>                                                                                                                                                                                                                                                                                                                                                             | <p><b>Loop</b></p> <div style="text-align: center;"> <table style="margin: auto;"> <tr> <td>O</td><td>D</td><td>I</td><td>S</td><td>Z</td><td>A</td><td>P</td><td>C</td> </tr> <tr> <td style="border: 1px solid black; width: 20px; height: 15px;"></td> <td style="border: 1px solid black; width: 20px; height: 15px;"></td> <td style="border: 1px solid black; width: 20px; height: 15px;"></td> <td style="border: 1px solid black; width: 20px; height: 15px;"></td> <td style="border: 1px solid black; width: 20px; height: 15px;"></td> <td style="border: 1px solid black; width: 20px; height: 15px;"></td> <td style="border: 1px solid black; width: 20px; height: 15px;"></td> <td style="border: 1px solid black; width: 20px; height: 15px;"></td> </tr> </table> </div> | O                       | D | I | S | Z | A | P | C |  |  |  |  |  |  |  |  |
|                                                                                                                                                                                                                                                                                                                                                                         | O                                                                                                                                                                                                                                                                                                                                                                                                                                                                                                                                                                                                                                                                                                                                                                                         | D                       | I | S | Z | A | P | C |   |  |  |  |  |  |  |  |  |
|                                                                                                                                                                                                                                                                                                                                                                         |                                                                                                                                                                                                                                                                                                                                                                                                                                                                                                                                                                                                                                                                                                                                                                                           |                         |   |   |   |   |   |   |   |  |  |  |  |  |  |  |  |
| <p>Decrements ECX and jumps to a short label if ECX is not equal to zero. The destination must be -128 to +127 bytes from the current location.</p> <p>Instruction formats:</p> <table style="width: 100%; border: none;"> <tr> <td style="text-align: center;"><i>LOOP shortlabel</i></td> <td style="text-align: center;"><i>LOOPW shortlabel</i></td> </tr> </table> | <i>LOOP shortlabel</i>                                                                                                                                                                                                                                                                                                                                                                                                                                                                                                                                                                                                                                                                                                                                                                    | <i>LOOPW shortlabel</i> |   |   |   |   |   |   |   |  |  |  |  |  |  |  |  |
| <i>LOOP shortlabel</i>                                                                                                                                                                                                                                                                                                                                                  | <i>LOOPW shortlabel</i>                                                                                                                                                                                                                                                                                                                                                                                                                                                                                                                                                                                                                                                                                                                                                                   |                         |   |   |   |   |   |   |   |  |  |  |  |  |  |  |  |

|                                                                                                                                                                                                                                           |                                                                                                                                                                                                                                                                                                                                                                                                                                                                                                                                                                                                                                                                                                                                                                                                 |   |   |   |   |   |   |   |   |  |  |  |  |  |  |  |  |
|-------------------------------------------------------------------------------------------------------------------------------------------------------------------------------------------------------------------------------------------|-------------------------------------------------------------------------------------------------------------------------------------------------------------------------------------------------------------------------------------------------------------------------------------------------------------------------------------------------------------------------------------------------------------------------------------------------------------------------------------------------------------------------------------------------------------------------------------------------------------------------------------------------------------------------------------------------------------------------------------------------------------------------------------------------|---|---|---|---|---|---|---|---|--|--|--|--|--|--|--|--|
| <b>LOOPD</b>                                                                                                                                                                                                                              | <p><b>Loop (x86)</b></p> <div style="text-align: center;"> <table style="margin: auto;"> <tr> <td>O</td><td>D</td><td>I</td><td>S</td><td>Z</td><td>A</td><td>P</td><td>C</td> </tr> <tr> <td style="border: 1px solid black; width: 20px; height: 15px;"></td> <td style="border: 1px solid black; width: 20px; height: 15px;"></td> <td style="border: 1px solid black; width: 20px; height: 15px;"></td> <td style="border: 1px solid black; width: 20px; height: 15px;"></td> <td style="border: 1px solid black; width: 20px; height: 15px;"></td> <td style="border: 1px solid black; width: 20px; height: 15px;"></td> <td style="border: 1px solid black; width: 20px; height: 15px;"></td> <td style="border: 1px solid black; width: 20px; height: 15px;"></td> </tr> </table> </div> | O | D | I | S | Z | A | P | C |  |  |  |  |  |  |  |  |
|                                                                                                                                                                                                                                           | O                                                                                                                                                                                                                                                                                                                                                                                                                                                                                                                                                                                                                                                                                                                                                                                               | D | I | S | Z | A | P | C |   |  |  |  |  |  |  |  |  |
|                                                                                                                                                                                                                                           |                                                                                                                                                                                                                                                                                                                                                                                                                                                                                                                                                                                                                                                                                                                                                                                                 |   |   |   |   |   |   |   |   |  |  |  |  |  |  |  |  |
| <p>Decrements ECX and jumps to a short label if ECX is not equal to zero. The destination must be -128 to +127 bytes from the current location.</p> <p>Instruction format:</p> <p style="text-align: center;"><i>LOOPD shortlabel</i></p> |                                                                                                                                                                                                                                                                                                                                                                                                                                                                                                                                                                                                                                                                                                                                                                                                 |   |   |   |   |   |   |   |   |  |  |  |  |  |  |  |  |

|                         |                                                                                                                                                                                                                                                                                                                              |
|-------------------------|------------------------------------------------------------------------------------------------------------------------------------------------------------------------------------------------------------------------------------------------------------------------------------------------------------------------------|
| <b>LOOPE,<br/>LOOPZ</b> | <b>Loop If Equal (Zero)</b><br><div style="text-align: center;">           O   D   I   S   Z   A   P   C<br/> <input type="checkbox"/> <input type="checkbox"/> <input type="checkbox"/> <input type="checkbox"/> <input type="checkbox"/> <input type="checkbox"/> <input type="checkbox"/> <input type="checkbox"/> </div> |
|                         | Decrements (E)CX and jumps to a short label if (E)CX > 0 and the Zero flag is set.<br>Instruction formats:<br><div style="text-align: center;"> <i>LOOPE shortlabel</i> <span style="margin-left: 200px;"><i>LOOPZ shortlabel</i></span> </div>                                                                              |

|                           |                                                                                                                                                                                                                                                                                                                                  |
|---------------------------|----------------------------------------------------------------------------------------------------------------------------------------------------------------------------------------------------------------------------------------------------------------------------------------------------------------------------------|
| <b>LOOPNE,<br/>LOOPNZ</b> | <b>Loop If Not Equal (Zero)</b><br><div style="text-align: center;">           O   D   I   S   Z   A   P   C<br/> <input type="checkbox"/> <input type="checkbox"/> <input type="checkbox"/> <input type="checkbox"/> <input type="checkbox"/> <input type="checkbox"/> <input type="checkbox"/> <input type="checkbox"/> </div> |
|                           | Decrements (E)CX and jumps to a short label if (E)CX > 0 and the Zero flag is clear.<br>Instruction formats:<br><div style="text-align: center;"> <i>LOOPNE shortlabel</i> <span style="margin-left: 200px;"><i>LOOPNZ shortlabel</i></span> </div>                                                                              |

|              |                                                                                                                                                                                                                                                                                                                                  |
|--------------|----------------------------------------------------------------------------------------------------------------------------------------------------------------------------------------------------------------------------------------------------------------------------------------------------------------------------------|
| <b>LOOPW</b> | <b>Loop with 16-bit Counter</b><br><div style="text-align: center;">           O   D   I   S   Z   A   P   C<br/> <input type="checkbox"/> <input type="checkbox"/> <input type="checkbox"/> <input type="checkbox"/> <input type="checkbox"/> <input type="checkbox"/> <input type="checkbox"/> <input type="checkbox"/> </div> |
|              | Decrements CX and jumps to a short label if CX is not equal to zero. The destination must be -128 to +127 bytes from the current location.<br>Instruction format:<br><div style="text-align: center;"> <i>LOOPW shortlabel</i> </div>                                                                                            |

|                          |                                                                                                                                                                                                                                                                                                                                                                                                                                                                                                                                                         |                     |                     |                     |                     |                     |                          |                          |                          |                          |
|--------------------------|---------------------------------------------------------------------------------------------------------------------------------------------------------------------------------------------------------------------------------------------------------------------------------------------------------------------------------------------------------------------------------------------------------------------------------------------------------------------------------------------------------------------------------------------------------|---------------------|---------------------|---------------------|---------------------|---------------------|--------------------------|--------------------------|--------------------------|--------------------------|
| <b>MOV</b>               | <b>Move</b><br><div style="text-align: center;">           O   D   I   S   Z   A   P   C<br/> <input type="checkbox"/> <input type="checkbox"/> <input type="checkbox"/> <input type="checkbox"/> <input type="checkbox"/> <input type="checkbox"/> <input type="checkbox"/> <input type="checkbox"/> </div>                                                                                                                                                                                                                                            |                     |                     |                     |                     |                     |                          |                          |                          |                          |
|                          | Copies a byte or word from a source operand to a destination operand.<br>Instruction formats:<br><div style="text-align: center;"> <table style="width: 100%; border: none;"> <tr> <td><i>MOV reg, reg</i></td> <td><i>MOV reg, imm</i></td> </tr> <tr> <td><i>MOV mem, reg</i></td> <td><i>MOV mem, imm</i></td> </tr> <tr> <td><i>MOV reg, mem</i></td> <td><i>MOV mem16, segreg</i></td> </tr> <tr> <td><i>MOV reg16, segreg</i></td> <td><i>MOV segreg, mem16</i></td> </tr> <tr> <td><i>MOV segreg, reg16</i></td> <td></td> </tr> </table> </div> | <i>MOV reg, reg</i> | <i>MOV reg, imm</i> | <i>MOV mem, reg</i> | <i>MOV mem, imm</i> | <i>MOV reg, mem</i> | <i>MOV mem16, segreg</i> | <i>MOV reg16, segreg</i> | <i>MOV segreg, mem16</i> | <i>MOV segreg, reg16</i> |
| <i>MOV reg, reg</i>      | <i>MOV reg, imm</i>                                                                                                                                                                                                                                                                                                                                                                                                                                                                                                                                     |                     |                     |                     |                     |                     |                          |                          |                          |                          |
| <i>MOV mem, reg</i>      | <i>MOV mem, imm</i>                                                                                                                                                                                                                                                                                                                                                                                                                                                                                                                                     |                     |                     |                     |                     |                     |                          |                          |                          |                          |
| <i>MOV reg, mem</i>      | <i>MOV mem16, segreg</i>                                                                                                                                                                                                                                                                                                                                                                                                                                                                                                                                |                     |                     |                     |                     |                     |                          |                          |                          |                          |
| <i>MOV reg16, segreg</i> | <i>MOV segreg, mem16</i>                                                                                                                                                                                                                                                                                                                                                                                                                                                                                                                                |                     |                     |                     |                     |                     |                          |                          |                          |                          |
| <i>MOV segreg, reg16</i> |                                                                                                                                                                                                                                                                                                                                                                                                                                                                                                                                                         |                     |                     |                     |                     |                     |                          |                          |                          |                          |

|                                                                                                                                                                                                                                                                                                                                                                                                                                                                                                                                                                                                                         |                                                                                                                                                                                                                                                                                                                                                                                                                                                                                                                                              |  |  |  |  |  |  |  |  |
|-------------------------------------------------------------------------------------------------------------------------------------------------------------------------------------------------------------------------------------------------------------------------------------------------------------------------------------------------------------------------------------------------------------------------------------------------------------------------------------------------------------------------------------------------------------------------------------------------------------------------|----------------------------------------------------------------------------------------------------------------------------------------------------------------------------------------------------------------------------------------------------------------------------------------------------------------------------------------------------------------------------------------------------------------------------------------------------------------------------------------------------------------------------------------------|--|--|--|--|--|--|--|--|
| <p><b>MOVS,<br/>MOVSB,<br/>MOVSW,<br/>MOVSD</b></p>                                                                                                                                                                                                                                                                                                                                                                                                                                                                                                                                                                     | <p><b>Move String</b></p> <p style="text-align: center;">O D I S Z A P C</p> <table border="1" style="margin: auto; border-collapse: collapse;"> <tr> <td style="width: 20px; height: 20px;"></td> <td style="width: 20px; height: 20px;"></td> <td style="width: 20px; height: 20px;"></td> <td style="width: 20px; height: 20px;"></td> <td style="width: 20px; height: 20px;"></td> <td style="width: 20px; height: 20px;"></td> <td style="width: 20px; height: 20px;"></td> <td style="width: 20px; height: 20px;"></td> </tr> </table> |  |  |  |  |  |  |  |  |
|                                                                                                                                                                                                                                                                                                                                                                                                                                                                                                                                                                                                                         |                                                                                                                                                                                                                                                                                                                                                                                                                                                                                                                                              |  |  |  |  |  |  |  |  |
| <p>Copies a byte or word from memory addressed by DS:(E)SI to memory addressed by ES:(E)DI. MOVSB requires both operands to be specified. MOVSB copies a byte, MOVSW copies a word, and on the x86, MOVSD copies a doubleword. (E)SI and (E)DI are increased or decreased according to the operand size and the status of the direction flag. If the Direction flag (DF) = 1, (E)SI and (E)DI are decreased; if DF = 0, (E)SI and (E)DI are increased.</p> <p>Instruction formats:</p> <p style="margin-left: 20px;">MOVSB<br/>MOVSW<br/>MOVSD<br/>MOVS <i>dest, source</i><br/>MOVS ES: <i>dest, segreg:source</i></p> |                                                                                                                                                                                                                                                                                                                                                                                                                                                                                                                                              |  |  |  |  |  |  |  |  |

|                                                                                                                                                                                                                                                                                                                                                                                                                                                                                                                                                                                                                                                                                                                                 |                                                                                                                                                                                                                                                                                                                                                                                                                                                                                                                                                        |                                 |                                  |                                  |                                 |                               |  |  |  |
|---------------------------------------------------------------------------------------------------------------------------------------------------------------------------------------------------------------------------------------------------------------------------------------------------------------------------------------------------------------------------------------------------------------------------------------------------------------------------------------------------------------------------------------------------------------------------------------------------------------------------------------------------------------------------------------------------------------------------------|--------------------------------------------------------------------------------------------------------------------------------------------------------------------------------------------------------------------------------------------------------------------------------------------------------------------------------------------------------------------------------------------------------------------------------------------------------------------------------------------------------------------------------------------------------|---------------------------------|----------------------------------|----------------------------------|---------------------------------|-------------------------------|--|--|--|
| <p><b>MOVSB</b></p>                                                                                                                                                                                                                                                                                                                                                                                                                                                                                                                                                                                                                                                                                                             | <p><b>Move with Sign-Extend</b></p> <p style="text-align: center;">O D I S Z A P C</p> <table border="1" style="margin: auto; border-collapse: collapse;"> <tr> <td style="width: 20px; height: 20px;"></td> <td style="width: 20px; height: 20px;"></td> <td style="width: 20px; height: 20px;"></td> <td style="width: 20px; height: 20px;"></td> <td style="width: 20px; height: 20px;"></td> <td style="width: 20px; height: 20px;"></td> <td style="width: 20px; height: 20px;"></td> <td style="width: 20px; height: 20px;"></td> </tr> </table> |                                 |                                  |                                  |                                 |                               |  |  |  |
|                                                                                                                                                                                                                                                                                                                                                                                                                                                                                                                                                                                                                                                                                                                                 |                                                                                                                                                                                                                                                                                                                                                                                                                                                                                                                                                        |                                 |                                  |                                  |                                 |                               |  |  |  |
| <p>Copies a byte or word from a source operand to a destination register and sign-extends into the upper bits of the destination. This instruction is used to copy an 8-bit or 16-bit operand into a larger destination.</p> <p>Instruction formats:</p> <table style="width: 100%; border: none;"> <tr> <td style="width: 60%;"></td> <td style="text-align: right;"><b>MOVSB</b> <i>reg32, reg8</i></td> </tr> <tr> <td style="text-align: right;"><b>MOVSB</b> <i>reg32, reg16</i></td> <td style="text-align: right;"><b>MOVSB</b> <i>reg32, mem16</i></td> </tr> <tr> <td style="text-align: right;"><b>MOVSB</b> <i>reg16, reg8</i></td> <td style="text-align: right;"><b>MOVSB</b> <i>reg16, m8</i></td> </tr> </table> |                                                                                                                                                                                                                                                                                                                                                                                                                                                                                                                                                        | <b>MOVSB</b> <i>reg32, reg8</i> | <b>MOVSB</b> <i>reg32, reg16</i> | <b>MOVSB</b> <i>reg32, mem16</i> | <b>MOVSB</b> <i>reg16, reg8</i> | <b>MOVSB</b> <i>reg16, m8</i> |  |  |  |
|                                                                                                                                                                                                                                                                                                                                                                                                                                                                                                                                                                                                                                                                                                                                 | <b>MOVSB</b> <i>reg32, reg8</i>                                                                                                                                                                                                                                                                                                                                                                                                                                                                                                                        |                                 |                                  |                                  |                                 |                               |  |  |  |
| <b>MOVSB</b> <i>reg32, reg16</i>                                                                                                                                                                                                                                                                                                                                                                                                                                                                                                                                                                                                                                                                                                | <b>MOVSB</b> <i>reg32, mem16</i>                                                                                                                                                                                                                                                                                                                                                                                                                                                                                                                       |                                 |                                  |                                  |                                 |                               |  |  |  |
| <b>MOVSB</b> <i>reg16, reg8</i>                                                                                                                                                                                                                                                                                                                                                                                                                                                                                                                                                                                                                                                                                                 | <b>MOVSB</b> <i>reg16, m8</i>                                                                                                                                                                                                                                                                                                                                                                                                                                                                                                                          |                                 |                                  |                                  |                                 |                               |  |  |  |
| <p><b>MOVZX</b></p>                                                                                                                                                                                                                                                                                                                                                                                                                                                                                                                                                                                                                                                                                                             | <p><b>Move with Zero-Extend</b></p> <p style="text-align: center;">O D I S Z A P C</p> <table border="1" style="margin: auto; border-collapse: collapse;"> <tr> <td style="width: 20px; height: 20px;"></td> <td style="width: 20px; height: 20px;"></td> <td style="width: 20px; height: 20px;"></td> <td style="width: 20px; height: 20px;"></td> <td style="width: 20px; height: 20px;"></td> <td style="width: 20px; height: 20px;"></td> <td style="width: 20px; height: 20px;"></td> <td style="width: 20px; height: 20px;"></td> </tr> </table> |                                 |                                  |                                  |                                 |                               |  |  |  |
|                                                                                                                                                                                                                                                                                                                                                                                                                                                                                                                                                                                                                                                                                                                                 |                                                                                                                                                                                                                                                                                                                                                                                                                                                                                                                                                        |                                 |                                  |                                  |                                 |                               |  |  |  |
| <p>Copies a byte or word from a source operand to a destination register and zero-extends into the upper bits of the destination. This instruction is used to copy an 8-bit or 16-bit operand into a larger destination.</p> <p>Instruction formats:</p> <table style="width: 100%; border: none;"> <tr> <td style="width: 60%;"></td> <td style="text-align: right;"><b>MOVZX</b> <i>reg32, reg8</i></td> </tr> <tr> <td style="text-align: right;"><b>MOVZX</b> <i>reg32, reg16</i></td> <td style="text-align: right;"><b>MOVZX</b> <i>reg32, mem16</i></td> </tr> <tr> <td style="text-align: right;"><b>MOVZX</b> <i>reg16, reg8</i></td> <td style="text-align: right;"><b>MOVZX</b> <i>reg16, m8</i></td> </tr> </table> |                                                                                                                                                                                                                                                                                                                                                                                                                                                                                                                                                        | <b>MOVZX</b> <i>reg32, reg8</i> | <b>MOVZX</b> <i>reg32, reg16</i> | <b>MOVZX</b> <i>reg32, mem16</i> | <b>MOVZX</b> <i>reg16, reg8</i> | <b>MOVZX</b> <i>reg16, m8</i> |  |  |  |
|                                                                                                                                                                                                                                                                                                                                                                                                                                                                                                                                                                                                                                                                                                                                 | <b>MOVZX</b> <i>reg32, reg8</i>                                                                                                                                                                                                                                                                                                                                                                                                                                                                                                                        |                                 |                                  |                                  |                                 |                               |  |  |  |
| <b>MOVZX</b> <i>reg32, reg16</i>                                                                                                                                                                                                                                                                                                                                                                                                                                                                                                                                                                                                                                                                                                | <b>MOVZX</b> <i>reg32, mem16</i>                                                                                                                                                                                                                                                                                                                                                                                                                                                                                                                       |                                 |                                  |                                  |                                 |                               |  |  |  |
| <b>MOVZX</b> <i>reg16, reg8</i>                                                                                                                                                                                                                                                                                                                                                                                                                                                                                                                                                                                                                                                                                                 | <b>MOVZX</b> <i>reg16, m8</i>                                                                                                                                                                                                                                                                                                                                                                                                                                                                                                                          |                                 |                                  |                                  |                                 |                               |  |  |  |

|            |                                                                                                                                                                                                                                                                                                                                                                                                                                                                                                                                                                                                                                                                                                       |   |   |   |   |   |   |   |   |   |  |  |   |   |   |   |
|------------|-------------------------------------------------------------------------------------------------------------------------------------------------------------------------------------------------------------------------------------------------------------------------------------------------------------------------------------------------------------------------------------------------------------------------------------------------------------------------------------------------------------------------------------------------------------------------------------------------------------------------------------------------------------------------------------------------------|---|---|---|---|---|---|---|---|---|--|--|---|---|---|---|
| <b>MUL</b> | <b>Unsigned Integer Multiply</b>                                                                                                                                                                                                                                                                                                                                                                                                                                                                                                                                                                                                                                                                      |   |   |   |   |   |   |   |   |   |  |  |   |   |   |   |
|            | <table border="1" style="margin: auto;"> <tr> <td style="padding: 2px 10px;">O</td> <td style="padding: 2px 10px;">D</td> <td style="padding: 2px 10px;">I</td> <td style="padding: 2px 10px;">S</td> <td style="padding: 2px 10px;">Z</td> <td style="padding: 2px 10px;">A</td> <td style="padding: 2px 10px;">P</td> <td style="padding: 2px 10px;">C</td> </tr> <tr> <td style="padding: 2px 10px;">*</td> <td style="padding: 2px 10px;"></td> <td style="padding: 2px 10px;"></td> <td style="padding: 2px 10px;">?</td> <td style="padding: 2px 10px;">?</td> <td style="padding: 2px 10px;">?</td> <td style="padding: 2px 10px;">?</td> <td style="padding: 2px 10px;">*</td> </tr> </table> | O | D | I | S | Z | A | P | C | * |  |  | ? | ? | ? | ? |
| O          | D                                                                                                                                                                                                                                                                                                                                                                                                                                                                                                                                                                                                                                                                                                     | I | S | Z | A | P | C |   |   |   |  |  |   |   |   |   |
| *          |                                                                                                                                                                                                                                                                                                                                                                                                                                                                                                                                                                                                                                                                                                       |   | ? | ? | ? | ? | * |   |   |   |  |  |   |   |   |   |
|            | <p>Multiplies AL, AX, or EAX by a source operand. If the source is 8 bits, it is multiplied by AL and the product is stored in AX. If the source is 16 bits, it is multiplied by AX and the product is stored in DX:AX. If the source is 32 bits, it is multiplied by EAX and the product is stored in EDX:EAX.</p> <p>Instruction formats:</p> <p style="text-align: center;"><code>MUL reg</code> <span style="margin-left: 200px;"><code>MUL mem</code></span></p>                                                                                                                                                                                                                                 |   |   |   |   |   |   |   |   |   |  |  |   |   |   |   |

|            |                                                                                                                                                                                                                                                                                                                                                                                                                                                                                                                                                                                                                                                                                                       |   |   |   |   |   |   |   |   |   |  |  |   |   |   |   |
|------------|-------------------------------------------------------------------------------------------------------------------------------------------------------------------------------------------------------------------------------------------------------------------------------------------------------------------------------------------------------------------------------------------------------------------------------------------------------------------------------------------------------------------------------------------------------------------------------------------------------------------------------------------------------------------------------------------------------|---|---|---|---|---|---|---|---|---|--|--|---|---|---|---|
| <b>NEG</b> | <b>Negate</b>                                                                                                                                                                                                                                                                                                                                                                                                                                                                                                                                                                                                                                                                                         |   |   |   |   |   |   |   |   |   |  |  |   |   |   |   |
|            | <table border="1" style="margin: auto;"> <tr> <td style="padding: 2px 10px;">O</td> <td style="padding: 2px 10px;">D</td> <td style="padding: 2px 10px;">I</td> <td style="padding: 2px 10px;">S</td> <td style="padding: 2px 10px;">Z</td> <td style="padding: 2px 10px;">A</td> <td style="padding: 2px 10px;">P</td> <td style="padding: 2px 10px;">C</td> </tr> <tr> <td style="padding: 2px 10px;">*</td> <td style="padding: 2px 10px;"></td> <td style="padding: 2px 10px;"></td> <td style="padding: 2px 10px;">*</td> <td style="padding: 2px 10px;">*</td> <td style="padding: 2px 10px;">*</td> <td style="padding: 2px 10px;">*</td> <td style="padding: 2px 10px;">*</td> </tr> </table> | O | D | I | S | Z | A | P | C | * |  |  | * | * | * | * |
| O          | D                                                                                                                                                                                                                                                                                                                                                                                                                                                                                                                                                                                                                                                                                                     | I | S | Z | A | P | C |   |   |   |  |  |   |   |   |   |
| *          |                                                                                                                                                                                                                                                                                                                                                                                                                                                                                                                                                                                                                                                                                                       |   | * | * | * | * | * |   |   |   |  |  |   |   |   |   |
|            | <p>Calculates the two's complement of the destination operand and stores the result in the destination.</p> <p>Instruction formats:</p> <p style="text-align: center;"><code>NEG reg</code> <span style="margin-left: 200px;"><code>NEG mem</code></span></p>                                                                                                                                                                                                                                                                                                                                                                                                                                         |   |   |   |   |   |   |   |   |   |  |  |   |   |   |   |

|            |                                                                                                                                                                                                                                                                                                                                                                                                                                                                                                                                                                                                                                                                                                 |   |   |   |   |   |   |   |   |  |  |  |  |  |  |  |
|------------|-------------------------------------------------------------------------------------------------------------------------------------------------------------------------------------------------------------------------------------------------------------------------------------------------------------------------------------------------------------------------------------------------------------------------------------------------------------------------------------------------------------------------------------------------------------------------------------------------------------------------------------------------------------------------------------------------|---|---|---|---|---|---|---|---|--|--|--|--|--|--|--|
| <b>NOP</b> | <b>No Operation</b>                                                                                                                                                                                                                                                                                                                                                                                                                                                                                                                                                                                                                                                                             |   |   |   |   |   |   |   |   |  |  |  |  |  |  |  |
|            | <table border="1" style="margin: auto;"> <tr> <td style="padding: 2px 10px;">O</td> <td style="padding: 2px 10px;">D</td> <td style="padding: 2px 10px;">I</td> <td style="padding: 2px 10px;">S</td> <td style="padding: 2px 10px;">Z</td> <td style="padding: 2px 10px;">A</td> <td style="padding: 2px 10px;">P</td> <td style="padding: 2px 10px;">C</td> </tr> <tr> <td style="padding: 2px 10px;"></td> <td style="padding: 2px 10px;"></td> <td style="padding: 2px 10px;"></td> <td style="padding: 2px 10px;"></td> <td style="padding: 2px 10px;"></td> <td style="padding: 2px 10px;"></td> <td style="padding: 2px 10px;"></td> <td style="padding: 2px 10px;"></td> </tr> </table> | O | D | I | S | Z | A | P | C |  |  |  |  |  |  |  |
| O          | D                                                                                                                                                                                                                                                                                                                                                                                                                                                                                                                                                                                                                                                                                               | I | S | Z | A | P | C |   |   |  |  |  |  |  |  |  |
|            |                                                                                                                                                                                                                                                                                                                                                                                                                                                                                                                                                                                                                                                                                                 |   |   |   |   |   |   |   |   |  |  |  |  |  |  |  |
|            | <p>This instruction does nothing, but it may be used inside a timing loop or to align a subsequent instruction on a word boundary.</p> <p>Instruction format:</p> <p style="text-align: center;"><code>NOP</code></p>                                                                                                                                                                                                                                                                                                                                                                                                                                                                           |   |   |   |   |   |   |   |   |  |  |  |  |  |  |  |

|            |                                                                                                                                                                                                                                                                                                                                                                                                                                                                                                                                                                                                                                                                                                 |   |   |   |   |   |   |   |   |  |  |  |  |  |  |  |
|------------|-------------------------------------------------------------------------------------------------------------------------------------------------------------------------------------------------------------------------------------------------------------------------------------------------------------------------------------------------------------------------------------------------------------------------------------------------------------------------------------------------------------------------------------------------------------------------------------------------------------------------------------------------------------------------------------------------|---|---|---|---|---|---|---|---|--|--|--|--|--|--|--|
| <b>NOT</b> | <b>Not</b>                                                                                                                                                                                                                                                                                                                                                                                                                                                                                                                                                                                                                                                                                      |   |   |   |   |   |   |   |   |  |  |  |  |  |  |  |
|            | <table border="1" style="margin: auto;"> <tr> <td style="padding: 2px 10px;">O</td> <td style="padding: 2px 10px;">D</td> <td style="padding: 2px 10px;">I</td> <td style="padding: 2px 10px;">S</td> <td style="padding: 2px 10px;">Z</td> <td style="padding: 2px 10px;">A</td> <td style="padding: 2px 10px;">P</td> <td style="padding: 2px 10px;">C</td> </tr> <tr> <td style="padding: 2px 10px;"></td> <td style="padding: 2px 10px;"></td> <td style="padding: 2px 10px;"></td> <td style="padding: 2px 10px;"></td> <td style="padding: 2px 10px;"></td> <td style="padding: 2px 10px;"></td> <td style="padding: 2px 10px;"></td> <td style="padding: 2px 10px;"></td> </tr> </table> | O | D | I | S | Z | A | P | C |  |  |  |  |  |  |  |
| O          | D                                                                                                                                                                                                                                                                                                                                                                                                                                                                                                                                                                                                                                                                                               | I | S | Z | A | P | C |   |   |  |  |  |  |  |  |  |
|            |                                                                                                                                                                                                                                                                                                                                                                                                                                                                                                                                                                                                                                                                                                 |   |   |   |   |   |   |   |   |  |  |  |  |  |  |  |
|            | <p>Performs a logical NOT operation on an operand by reversing each of its bits.</p> <p>Instruction formats:</p> <p style="text-align: center;"><code>NOT reg</code> <span style="margin-left: 200px;"><code>NOT mem</code></span></p>                                                                                                                                                                                                                                                                                                                                                                                                                                                          |   |   |   |   |   |   |   |   |  |  |  |  |  |  |  |

|                                                                                                                                                                                                                                                                                                                                                                                                                                                                                                                                                                                                        |                                                                                                                                                                                                                                                                                                                                                                                                                                                                                                                                                                                                                                                                                                                                                                                                                                                                                                                                                                     |                    |                    |                    |                    |                      |   |   |   |   |  |  |   |   |   |   |   |
|--------------------------------------------------------------------------------------------------------------------------------------------------------------------------------------------------------------------------------------------------------------------------------------------------------------------------------------------------------------------------------------------------------------------------------------------------------------------------------------------------------------------------------------------------------------------------------------------------------|---------------------------------------------------------------------------------------------------------------------------------------------------------------------------------------------------------------------------------------------------------------------------------------------------------------------------------------------------------------------------------------------------------------------------------------------------------------------------------------------------------------------------------------------------------------------------------------------------------------------------------------------------------------------------------------------------------------------------------------------------------------------------------------------------------------------------------------------------------------------------------------------------------------------------------------------------------------------|--------------------|--------------------|--------------------|--------------------|----------------------|---|---|---|---|--|--|---|---|---|---|---|
| <b>OR</b>                                                                                                                                                                                                                                                                                                                                                                                                                                                                                                                                                                                              | <p><b>Inclusive OR</b></p> <table style="margin-left: auto; margin-right: auto; border-collapse: collapse;"> <tr> <td style="padding: 2px 10px;">O</td><td style="padding: 2px 10px;">D</td><td style="padding: 2px 10px;">I</td><td style="padding: 2px 10px;">S</td><td style="padding: 2px 10px;">Z</td><td style="padding: 2px 10px;">A</td><td style="padding: 2px 10px;">P</td><td style="padding: 2px 10px;">C</td> </tr> <tr> <td style="padding: 2px 10px; border: 1px solid black;">0</td><td style="padding: 2px 10px; border: 1px solid black;"></td><td style="padding: 2px 10px; border: 1px solid black;"></td><td style="padding: 2px 10px; border: 1px solid black;">*</td><td style="padding: 2px 10px; border: 1px solid black;">*</td><td style="padding: 2px 10px; border: 1px solid black;">?</td><td style="padding: 2px 10px; border: 1px solid black;">*</td><td style="padding: 2px 10px; border: 1px solid black;">0</td> </tr> </table> | O                  | D                  | I                  | S                  | Z                    | A | P | C | 0 |  |  | * | * | ? | * | 0 |
|                                                                                                                                                                                                                                                                                                                                                                                                                                                                                                                                                                                                        | O                                                                                                                                                                                                                                                                                                                                                                                                                                                                                                                                                                                                                                                                                                                                                                                                                                                                                                                                                                   | D                  | I                  | S                  | Z                  | A                    | P | C |   |   |  |  |   |   |   |   |   |
| 0                                                                                                                                                                                                                                                                                                                                                                                                                                                                                                                                                                                                      |                                                                                                                                                                                                                                                                                                                                                                                                                                                                                                                                                                                                                                                                                                                                                                                                                                                                                                                                                                     |                    | *                  | *                  | ?                  | *                    | 0 |   |   |   |  |  |   |   |   |   |   |
| <p>Performs a boolean (bitwise) OR operation between each matching bit in the destination operand and each bit in the source operand.</p> <p>Instruction formats:</p> <table style="width: 100%; border: none;"> <tr> <td style="padding: 2px 20px;">OR <i>reg, reg</i></td> <td style="padding: 2px 20px;">OR <i>reg, imm</i></td> </tr> <tr> <td style="padding: 2px 20px;">OR <i>mem, reg</i></td> <td style="padding: 2px 20px;">OR <i>mem, imm</i></td> </tr> <tr> <td style="padding: 2px 20px;">OR <i>reg, mem</i></td> <td style="padding: 2px 20px;">OR <i>accum, imm</i></td> </tr> </table> | OR <i>reg, reg</i>                                                                                                                                                                                                                                                                                                                                                                                                                                                                                                                                                                                                                                                                                                                                                                                                                                                                                                                                                  | OR <i>reg, imm</i> | OR <i>mem, reg</i> | OR <i>mem, imm</i> | OR <i>reg, mem</i> | OR <i>accum, imm</i> |   |   |   |   |  |  |   |   |   |   |   |
| OR <i>reg, reg</i>                                                                                                                                                                                                                                                                                                                                                                                                                                                                                                                                                                                     | OR <i>reg, imm</i>                                                                                                                                                                                                                                                                                                                                                                                                                                                                                                                                                                                                                                                                                                                                                                                                                                                                                                                                                  |                    |                    |                    |                    |                      |   |   |   |   |  |  |   |   |   |   |   |
| OR <i>mem, reg</i>                                                                                                                                                                                                                                                                                                                                                                                                                                                                                                                                                                                     | OR <i>mem, imm</i>                                                                                                                                                                                                                                                                                                                                                                                                                                                                                                                                                                                                                                                                                                                                                                                                                                                                                                                                                  |                    |                    |                    |                    |                      |   |   |   |   |  |  |   |   |   |   |   |
| OR <i>reg, mem</i>                                                                                                                                                                                                                                                                                                                                                                                                                                                                                                                                                                                     | OR <i>accum, imm</i>                                                                                                                                                                                                                                                                                                                                                                                                                                                                                                                                                                                                                                                                                                                                                                                                                                                                                                                                                |                    |                    |                    |                    |                      |   |   |   |   |  |  |   |   |   |   |   |

|                                                                                                                                                                                                                                                                                                                                                                                                                                                                                                                  |                                                                                                                                                                                                                                                                                                                                                                                                                                                                                                                                                                                                                                                                                                                                                                                                                                                                                                                                                                 |                      |   |   |   |   |   |   |   |  |  |  |  |  |  |  |  |
|------------------------------------------------------------------------------------------------------------------------------------------------------------------------------------------------------------------------------------------------------------------------------------------------------------------------------------------------------------------------------------------------------------------------------------------------------------------------------------------------------------------|-----------------------------------------------------------------------------------------------------------------------------------------------------------------------------------------------------------------------------------------------------------------------------------------------------------------------------------------------------------------------------------------------------------------------------------------------------------------------------------------------------------------------------------------------------------------------------------------------------------------------------------------------------------------------------------------------------------------------------------------------------------------------------------------------------------------------------------------------------------------------------------------------------------------------------------------------------------------|----------------------|---|---|---|---|---|---|---|--|--|--|--|--|--|--|--|
| <b>OUT</b>                                                                                                                                                                                                                                                                                                                                                                                                                                                                                                       | <p><b>Output to Port</b></p> <table style="margin-left: auto; margin-right: auto; border-collapse: collapse;"> <tr> <td style="padding: 2px 10px;">O</td><td style="padding: 2px 10px;">D</td><td style="padding: 2px 10px;">I</td><td style="padding: 2px 10px;">S</td><td style="padding: 2px 10px;">Z</td><td style="padding: 2px 10px;">A</td><td style="padding: 2px 10px;">P</td><td style="padding: 2px 10px;">C</td> </tr> <tr> <td style="padding: 2px 10px; border: 1px solid black;"></td><td style="padding: 2px 10px; border: 1px solid black;"></td><td style="padding: 2px 10px; border: 1px solid black;"></td><td style="padding: 2px 10px; border: 1px solid black;"></td><td style="padding: 2px 10px; border: 1px solid black;"></td><td style="padding: 2px 10px; border: 1px solid black;"></td><td style="padding: 2px 10px; border: 1px solid black;"></td><td style="padding: 2px 10px; border: 1px solid black;"></td> </tr> </table> | O                    | D | I | S | Z | A | P | C |  |  |  |  |  |  |  |  |
|                                                                                                                                                                                                                                                                                                                                                                                                                                                                                                                  | O                                                                                                                                                                                                                                                                                                                                                                                                                                                                                                                                                                                                                                                                                                                                                                                                                                                                                                                                                               | D                    | I | S | Z | A | P | C |   |  |  |  |  |  |  |  |  |
|                                                                                                                                                                                                                                                                                                                                                                                                                                                                                                                  |                                                                                                                                                                                                                                                                                                                                                                                                                                                                                                                                                                                                                                                                                                                                                                                                                                                                                                                                                                 |                      |   |   |   |   |   |   |   |  |  |  |  |  |  |  |  |
| <p>When using processors prior to the x86, this instruction outputs a byte or word from the accumulator to a port. The port address may be a constant if in the range 0–FFh, or DX may contain a port address between 0 and FFFFh. On an x86 processor, a doubleword can be output to a port.</p> <p>Instruction formats:</p> <table style="width: 100%; border: none;"> <tr> <td style="padding: 2px 20px;">OUT <i>imm8, accum</i></td> <td style="padding: 2px 20px;">OUT <i>DX, accum</i></td> </tr> </table> | OUT <i>imm8, accum</i>                                                                                                                                                                                                                                                                                                                                                                                                                                                                                                                                                                                                                                                                                                                                                                                                                                                                                                                                          | OUT <i>DX, accum</i> |   |   |   |   |   |   |   |  |  |  |  |  |  |  |  |
| OUT <i>imm8, accum</i>                                                                                                                                                                                                                                                                                                                                                                                                                                                                                           | OUT <i>DX, accum</i>                                                                                                                                                                                                                                                                                                                                                                                                                                                                                                                                                                                                                                                                                                                                                                                                                                                                                                                                            |                      |   |   |   |   |   |   |   |  |  |  |  |  |  |  |  |

|                                                                                                                                                                                                                                                                                                                                                                                                                                                                                                                                                                                                                       |                                                                                                                                                                                                                                                                                                                                                                                                                                                                                                                                                                                                                                                                                                                                                                                                                                                                                                                                                                                |                           |                           |                           |   |   |   |   |   |  |  |  |  |  |  |  |  |
|-----------------------------------------------------------------------------------------------------------------------------------------------------------------------------------------------------------------------------------------------------------------------------------------------------------------------------------------------------------------------------------------------------------------------------------------------------------------------------------------------------------------------------------------------------------------------------------------------------------------------|--------------------------------------------------------------------------------------------------------------------------------------------------------------------------------------------------------------------------------------------------------------------------------------------------------------------------------------------------------------------------------------------------------------------------------------------------------------------------------------------------------------------------------------------------------------------------------------------------------------------------------------------------------------------------------------------------------------------------------------------------------------------------------------------------------------------------------------------------------------------------------------------------------------------------------------------------------------------------------|---------------------------|---------------------------|---------------------------|---|---|---|---|---|--|--|--|--|--|--|--|--|
| <b>OUTS,<br/>OUTSB,<br/>OUTSW,<br/>OUTSD</b>                                                                                                                                                                                                                                                                                                                                                                                                                                                                                                                                                                          | <p><b>Output String to Port (80286)</b></p> <table style="margin-left: auto; margin-right: auto; border-collapse: collapse;"> <tr> <td style="padding: 2px 10px;">O</td><td style="padding: 2px 10px;">D</td><td style="padding: 2px 10px;">I</td><td style="padding: 2px 10px;">S</td><td style="padding: 2px 10px;">Z</td><td style="padding: 2px 10px;">A</td><td style="padding: 2px 10px;">P</td><td style="padding: 2px 10px;">C</td> </tr> <tr> <td style="padding: 2px 10px; border: 1px solid black;"></td><td style="padding: 2px 10px; border: 1px solid black;"></td><td style="padding: 2px 10px; border: 1px solid black;"></td><td style="padding: 2px 10px; border: 1px solid black;"></td><td style="padding: 2px 10px; border: 1px solid black;"></td><td style="padding: 2px 10px; border: 1px solid black;"></td><td style="padding: 2px 10px; border: 1px solid black;"></td><td style="padding: 2px 10px; border: 1px solid black;"></td> </tr> </table> | O                         | D                         | I                         | S | Z | A | P | C |  |  |  |  |  |  |  |  |
|                                                                                                                                                                                                                                                                                                                                                                                                                                                                                                                                                                                                                       | O                                                                                                                                                                                                                                                                                                                                                                                                                                                                                                                                                                                                                                                                                                                                                                                                                                                                                                                                                                              | D                         | I                         | S                         | Z | A | P | C |   |  |  |  |  |  |  |  |  |
|                                                                                                                                                                                                                                                                                                                                                                                                                                                                                                                                                                                                                       |                                                                                                                                                                                                                                                                                                                                                                                                                                                                                                                                                                                                                                                                                                                                                                                                                                                                                                                                                                                |                           |                           |                           |   |   |   |   |   |  |  |  |  |  |  |  |  |
| <p>Outputs a string pointed to by ES:(E)DI to a port. The port number is specified in DX. For each value output, (E)DI is adjusted in the same way as LODSB and similar string primitive instructions. The REP prefix may be used with this instruction.</p> <p>Instruction formats:</p> <table style="width: 100%; border: none;"> <tr> <td style="padding: 2px 20px;">OUTS <i>dest, DX</i></td> <td style="padding: 2px 20px;">REP OUTSB <i>dest, DX</i></td> </tr> <tr> <td style="padding: 2px 20px;">REP OUTSW <i>dest, DX</i></td> <td style="padding: 2px 20px;">REP OUTSD <i>dest, DX</i></td> </tr> </table> | OUTS <i>dest, DX</i>                                                                                                                                                                                                                                                                                                                                                                                                                                                                                                                                                                                                                                                                                                                                                                                                                                                                                                                                                           | REP OUTSB <i>dest, DX</i> | REP OUTSW <i>dest, DX</i> | REP OUTSD <i>dest, DX</i> |   |   |   |   |   |  |  |  |  |  |  |  |  |
| OUTS <i>dest, DX</i>                                                                                                                                                                                                                                                                                                                                                                                                                                                                                                                                                                                                  | REP OUTSB <i>dest, DX</i>                                                                                                                                                                                                                                                                                                                                                                                                                                                                                                                                                                                                                                                                                                                                                                                                                                                                                                                                                      |                           |                           |                           |   |   |   |   |   |  |  |  |  |  |  |  |  |
| REP OUTSW <i>dest, DX</i>                                                                                                                                                                                                                                                                                                                                                                                                                                                                                                                                                                                             | REP OUTSD <i>dest, DX</i>                                                                                                                                                                                                                                                                                                                                                                                                                                                                                                                                                                                                                                                                                                                                                                                                                                                                                                                                                      |                           |                           |                           |   |   |   |   |   |  |  |  |  |  |  |  |  |

|                                                                                                                                                                                                                                                                                                                                                                                                                             |                                                                                                                                                                                                                                                                                                                                                                                                                                                                                                                                                                                                                                                                                                                                                                                                                                                                                                                                                                 |                   |                        |   |   |   |   |   |   |  |  |  |  |  |  |  |  |
|-----------------------------------------------------------------------------------------------------------------------------------------------------------------------------------------------------------------------------------------------------------------------------------------------------------------------------------------------------------------------------------------------------------------------------|-----------------------------------------------------------------------------------------------------------------------------------------------------------------------------------------------------------------------------------------------------------------------------------------------------------------------------------------------------------------------------------------------------------------------------------------------------------------------------------------------------------------------------------------------------------------------------------------------------------------------------------------------------------------------------------------------------------------------------------------------------------------------------------------------------------------------------------------------------------------------------------------------------------------------------------------------------------------|-------------------|------------------------|---|---|---|---|---|---|--|--|--|--|--|--|--|--|
| <b>POP</b>                                                                                                                                                                                                                                                                                                                                                                                                                  | <p><b>Pop from Stack</b></p> <table style="margin-left: auto; margin-right: auto; border-collapse: collapse;"> <tr> <td style="padding: 2px 10px;">O</td><td style="padding: 2px 10px;">D</td><td style="padding: 2px 10px;">I</td><td style="padding: 2px 10px;">S</td><td style="padding: 2px 10px;">Z</td><td style="padding: 2px 10px;">A</td><td style="padding: 2px 10px;">P</td><td style="padding: 2px 10px;">C</td> </tr> <tr> <td style="padding: 2px 10px; border: 1px solid black;"></td><td style="padding: 2px 10px; border: 1px solid black;"></td><td style="padding: 2px 10px; border: 1px solid black;"></td><td style="padding: 2px 10px; border: 1px solid black;"></td><td style="padding: 2px 10px; border: 1px solid black;"></td><td style="padding: 2px 10px; border: 1px solid black;"></td><td style="padding: 2px 10px; border: 1px solid black;"></td><td style="padding: 2px 10px; border: 1px solid black;"></td> </tr> </table> | O                 | D                      | I | S | Z | A | P | C |  |  |  |  |  |  |  |  |
|                                                                                                                                                                                                                                                                                                                                                                                                                             | O                                                                                                                                                                                                                                                                                                                                                                                                                                                                                                                                                                                                                                                                                                                                                                                                                                                                                                                                                               | D                 | I                      | S | Z | A | P | C |   |  |  |  |  |  |  |  |  |
|                                                                                                                                                                                                                                                                                                                                                                                                                             |                                                                                                                                                                                                                                                                                                                                                                                                                                                                                                                                                                                                                                                                                                                                                                                                                                                                                                                                                                 |                   |                        |   |   |   |   |   |   |  |  |  |  |  |  |  |  |
| <p>Copies a word or doubleword at the current stack pointer location into the destination operand and adds 2 (or 4) to (E)SP.</p> <p>Instruction formats:</p> <table style="width: 100%; border: none;"> <tr> <td style="padding: 2px 20px;">POP <i>reg16/r32</i></td> <td style="padding: 2px 20px;">POP <i>segreg</i></td> </tr> <tr> <td style="padding: 2px 20px;">POP <i>mem16/mem32</i></td> <td></td> </tr> </table> | POP <i>reg16/r32</i>                                                                                                                                                                                                                                                                                                                                                                                                                                                                                                                                                                                                                                                                                                                                                                                                                                                                                                                                            | POP <i>segreg</i> | POP <i>mem16/mem32</i> |   |   |   |   |   |   |  |  |  |  |  |  |  |  |
| POP <i>reg16/r32</i>                                                                                                                                                                                                                                                                                                                                                                                                        | POP <i>segreg</i>                                                                                                                                                                                                                                                                                                                                                                                                                                                                                                                                                                                                                                                                                                                                                                                                                                                                                                                                               |                   |                        |   |   |   |   |   |   |  |  |  |  |  |  |  |  |
| POP <i>mem16/mem32</i>                                                                                                                                                                                                                                                                                                                                                                                                      |                                                                                                                                                                                                                                                                                                                                                                                                                                                                                                                                                                                                                                                                                                                                                                                                                                                                                                                                                                 |                   |                        |   |   |   |   |   |   |  |  |  |  |  |  |  |  |

|                        |                                                                                                                                                                                                                                                                                                                                                                                                                                                                                                                                                                                                                                                                                                                               |  |  |  |  |  |  |  |
|------------------------|-------------------------------------------------------------------------------------------------------------------------------------------------------------------------------------------------------------------------------------------------------------------------------------------------------------------------------------------------------------------------------------------------------------------------------------------------------------------------------------------------------------------------------------------------------------------------------------------------------------------------------------------------------------------------------------------------------------------------------|--|--|--|--|--|--|--|
| <b>POPA,<br/>POPAD</b> | <b>Pop All</b>                                                                                                                                                                                                                                                                                                                                                                                                                                                                                                                                                                                                                                                                                                                |  |  |  |  |  |  |  |
|                        | <p style="text-align: center;">O   D   I   S   Z   A   P   C</p> <table style="margin: auto; border-collapse: collapse;"> <tr> <td style="border: 1px solid black; width: 20px; height: 20px;"></td> <td style="border: 1px solid black; width: 20px; height: 20px;"></td> <td style="border: 1px solid black; width: 20px; height: 20px;"></td> <td style="border: 1px solid black; width: 20px; height: 20px;"></td> <td style="border: 1px solid black; width: 20px; height: 20px;"></td> <td style="border: 1px solid black; width: 20px; height: 20px;"></td> <td style="border: 1px solid black; width: 20px; height: 20px;"></td> <td style="border: 1px solid black; width: 20px; height: 20px;"></td> </tr> </table> |  |  |  |  |  |  |  |
|                        |                                                                                                                                                                                                                                                                                                                                                                                                                                                                                                                                                                                                                                                                                                                               |  |  |  |  |  |  |  |
|                        | <p>Pops 16 bytes from the top of the stack into the eight general-purpose registers, in the following order: DI, SI, BP, SP, BX, DX, CX, AX. The value for SP is discarded, so SP is not reassigned. POPA pops into 16-bit registers, and POPAD on an x86 pops into 32-bit registers.</p> <p>Instruction formats:</p> <p style="text-align: center;">POPA <span style="margin-left: 200px;">POPAD</span></p>                                                                                                                                                                                                                                                                                                                  |  |  |  |  |  |  |  |

|                       |                                                                                                                                                                                                                                                                                                                                                                                                                                                                                                                                                                                                                                                                                                                                                                                                                                                                                                       |   |   |   |   |   |   |   |
|-----------------------|-------------------------------------------------------------------------------------------------------------------------------------------------------------------------------------------------------------------------------------------------------------------------------------------------------------------------------------------------------------------------------------------------------------------------------------------------------------------------------------------------------------------------------------------------------------------------------------------------------------------------------------------------------------------------------------------------------------------------------------------------------------------------------------------------------------------------------------------------------------------------------------------------------|---|---|---|---|---|---|---|
| <b>POPF,<br/>POPF</b> | <b>Pop Flags from Stack</b>                                                                                                                                                                                                                                                                                                                                                                                                                                                                                                                                                                                                                                                                                                                                                                                                                                                                           |   |   |   |   |   |   |   |
|                       | <p style="text-align: center;">O   D   I   S   Z   A   P   C</p> <table style="margin: auto; border-collapse: collapse;"> <tr> <td style="border: 1px solid black; width: 20px; height: 20px; text-align: center;">*</td> <td style="border: 1px solid black; width: 20px; height: 20px; text-align: center;">*</td> <td style="border: 1px solid black; width: 20px; height: 20px; text-align: center;">*</td> <td style="border: 1px solid black; width: 20px; height: 20px; text-align: center;">*</td> <td style="border: 1px solid black; width: 20px; height: 20px; text-align: center;">*</td> <td style="border: 1px solid black; width: 20px; height: 20px; text-align: center;">*</td> <td style="border: 1px solid black; width: 20px; height: 20px; text-align: center;">*</td> <td style="border: 1px solid black; width: 20px; height: 20px; text-align: center;">*</td> </tr> </table> | * | * | * | * | * | * | * |
| *                     | *                                                                                                                                                                                                                                                                                                                                                                                                                                                                                                                                                                                                                                                                                                                                                                                                                                                                                                     | * | * | * | * | * | * |   |
|                       | <p>POPF pops the top of the stack into the 16-bit FLAGS register. POPFD on an x86 pops the top of the stack into the 32-bit EFLAGS register.</p> <p>Instruction formats:</p> <p style="text-align: center;">POPF <span style="margin-left: 200px;">POPFD</span></p>                                                                                                                                                                                                                                                                                                                                                                                                                                                                                                                                                                                                                                   |   |   |   |   |   |   |   |

|             |                                                                                                                                                                                                                                                                                                                                                                                                                                                                                                                                                                                                                                                                                                                               |  |  |  |  |  |  |  |
|-------------|-------------------------------------------------------------------------------------------------------------------------------------------------------------------------------------------------------------------------------------------------------------------------------------------------------------------------------------------------------------------------------------------------------------------------------------------------------------------------------------------------------------------------------------------------------------------------------------------------------------------------------------------------------------------------------------------------------------------------------|--|--|--|--|--|--|--|
| <b>PUSH</b> | <b>Push on Stack</b>                                                                                                                                                                                                                                                                                                                                                                                                                                                                                                                                                                                                                                                                                                          |  |  |  |  |  |  |  |
|             | <p style="text-align: center;">O   D   I   S   Z   A   P   C</p> <table style="margin: auto; border-collapse: collapse;"> <tr> <td style="border: 1px solid black; width: 20px; height: 20px;"></td> <td style="border: 1px solid black; width: 20px; height: 20px;"></td> <td style="border: 1px solid black; width: 20px; height: 20px;"></td> <td style="border: 1px solid black; width: 20px; height: 20px;"></td> <td style="border: 1px solid black; width: 20px; height: 20px;"></td> <td style="border: 1px solid black; width: 20px; height: 20px;"></td> <td style="border: 1px solid black; width: 20px; height: 20px;"></td> <td style="border: 1px solid black; width: 20px; height: 20px;"></td> </tr> </table> |  |  |  |  |  |  |  |
|             |                                                                                                                                                                                                                                                                                                                                                                                                                                                                                                                                                                                                                                                                                                                               |  |  |  |  |  |  |  |
|             | <p>If a 16-bit operand is pushed, 2 is subtracted from ESP. If a 32-bit operand is pushed, 4 is subtracted from ESP. Next, the operand is copied into the stack at the location pointed to by ESP.</p> <p>Instruction formats:</p> <p style="text-align: center;">PUSH <i>reg16/reg32</i> <span style="margin-left: 100px;">PUSH <i>segreg</i></span><br/> PUSH <i>mem16/mem32</i> <span style="margin-left: 100px;">PUSH <i>imm16/imm32</i></span></p>                                                                                                                                                                                                                                                                       |  |  |  |  |  |  |  |

|                          |                                                                                                                                                                                                                                                                                                                                                                                                                                                                                                                                                                                                                                                                                                                               |  |  |  |  |  |  |  |
|--------------------------|-------------------------------------------------------------------------------------------------------------------------------------------------------------------------------------------------------------------------------------------------------------------------------------------------------------------------------------------------------------------------------------------------------------------------------------------------------------------------------------------------------------------------------------------------------------------------------------------------------------------------------------------------------------------------------------------------------------------------------|--|--|--|--|--|--|--|
| <b>PUSHA,<br/>PUSHAD</b> | <b>Push All (80286)</b>                                                                                                                                                                                                                                                                                                                                                                                                                                                                                                                                                                                                                                                                                                       |  |  |  |  |  |  |  |
|                          | <p style="text-align: center;">O   D   I   S   Z   A   P   C</p> <table style="margin: auto; border-collapse: collapse;"> <tr> <td style="border: 1px solid black; width: 20px; height: 20px;"></td> <td style="border: 1px solid black; width: 20px; height: 20px;"></td> <td style="border: 1px solid black; width: 20px; height: 20px;"></td> <td style="border: 1px solid black; width: 20px; height: 20px;"></td> <td style="border: 1px solid black; width: 20px; height: 20px;"></td> <td style="border: 1px solid black; width: 20px; height: 20px;"></td> <td style="border: 1px solid black; width: 20px; height: 20px;"></td> <td style="border: 1px solid black; width: 20px; height: 20px;"></td> </tr> </table> |  |  |  |  |  |  |  |
|                          |                                                                                                                                                                                                                                                                                                                                                                                                                                                                                                                                                                                                                                                                                                                               |  |  |  |  |  |  |  |
|                          | <p>Pushes the following 16-bit registers on the stack, in order: AX, CX, DX, BX, SP, BP, SI, and DI. The PUSHAD instruction for the x86 processor pushes EAX, ECX, EDX, EBX, ESP, EBP, ESI, and EDI.</p> <p>Instruction formats:</p> <p style="text-align: center;">PUSHA <span style="margin-left: 200px;">PUSHAD</span></p>                                                                                                                                                                                                                                                                                                                                                                                                 |  |  |  |  |  |  |  |

|                                                                                                                                                                                                                                                                             |                                                                                                                                                                                                                                                                                                                                                                                                                                                                                                                                                                                                                                                                                                                                                                                                                                                                                                                                                                                                                                                             |   |   |   |   |   |   |   |   |  |  |  |  |  |  |  |  |
|-----------------------------------------------------------------------------------------------------------------------------------------------------------------------------------------------------------------------------------------------------------------------------|-------------------------------------------------------------------------------------------------------------------------------------------------------------------------------------------------------------------------------------------------------------------------------------------------------------------------------------------------------------------------------------------------------------------------------------------------------------------------------------------------------------------------------------------------------------------------------------------------------------------------------------------------------------------------------------------------------------------------------------------------------------------------------------------------------------------------------------------------------------------------------------------------------------------------------------------------------------------------------------------------------------------------------------------------------------|---|---|---|---|---|---|---|---|--|--|--|--|--|--|--|--|
| <b>PUSHF, PUSHFD</b>                                                                                                                                                                                                                                                        | <p><b>Push Flags</b></p> <div style="text-align: center; margin: 10px 0;"> <table style="margin: 0 auto; border-collapse: collapse;"> <tr> <td style="padding: 0 10px;">O</td> <td style="padding: 0 10px;">D</td> <td style="padding: 0 10px;">I</td> <td style="padding: 0 10px;">S</td> <td style="padding: 0 10px;">Z</td> <td style="padding: 0 10px;">A</td> <td style="padding: 0 10px;">P</td> <td style="padding: 0 10px;">C</td> </tr> <tr> <td style="border: 1px solid black; width: 20px; height: 20px;"></td> <td style="border: 1px solid black; width: 20px; height: 20px;"></td> <td style="border: 1px solid black; width: 20px; height: 20px;"></td> <td style="border: 1px solid black; width: 20px; height: 20px;"></td> <td style="border: 1px solid black; width: 20px; height: 20px;"></td> <td style="border: 1px solid black; width: 20px; height: 20px;"></td> <td style="border: 1px solid black; width: 20px; height: 20px;"></td> <td style="border: 1px solid black; width: 20px; height: 20px;"></td> </tr> </table> </div> | O | D | I | S | Z | A | P | C |  |  |  |  |  |  |  |  |
|                                                                                                                                                                                                                                                                             | O                                                                                                                                                                                                                                                                                                                                                                                                                                                                                                                                                                                                                                                                                                                                                                                                                                                                                                                                                                                                                                                           | D | I | S | Z | A | P | C |   |  |  |  |  |  |  |  |  |
|                                                                                                                                                                                                                                                                             |                                                                                                                                                                                                                                                                                                                                                                                                                                                                                                                                                                                                                                                                                                                                                                                                                                                                                                                                                                                                                                                             |   |   |   |   |   |   |   |   |  |  |  |  |  |  |  |  |
| <p>PUSHF pushes the 16-bit FLAGS register onto the stack. PUSHFD pushes the 32-bit EFLAGS onto the stack (x86).</p> <p>Instruction formats:</p> <div style="display: flex; justify-content: space-around; margin-top: 10px;"> <span>PUSHF</span> <span>PUSHFD</span> </div> |                                                                                                                                                                                                                                                                                                                                                                                                                                                                                                                                                                                                                                                                                                                                                                                                                                                                                                                                                                                                                                                             |   |   |   |   |   |   |   |   |  |  |  |  |  |  |  |  |

|                                                                                                                                                                                                                                                                                                                                                                                                                                           |                                                                                                                                                                                                                                                                                                                                                                                                                                                                                                                                                                                                                                                                                                                                                                                                                                                                                                                                                                                                                                                                |   |   |   |   |   |   |   |   |  |  |  |  |  |  |  |  |
|-------------------------------------------------------------------------------------------------------------------------------------------------------------------------------------------------------------------------------------------------------------------------------------------------------------------------------------------------------------------------------------------------------------------------------------------|----------------------------------------------------------------------------------------------------------------------------------------------------------------------------------------------------------------------------------------------------------------------------------------------------------------------------------------------------------------------------------------------------------------------------------------------------------------------------------------------------------------------------------------------------------------------------------------------------------------------------------------------------------------------------------------------------------------------------------------------------------------------------------------------------------------------------------------------------------------------------------------------------------------------------------------------------------------------------------------------------------------------------------------------------------------|---|---|---|---|---|---|---|---|--|--|--|--|--|--|--|--|
| <b>PUSHW, PUSHD</b>                                                                                                                                                                                                                                                                                                                                                                                                                       | <p><b>Push on Stack</b></p> <div style="text-align: center; margin: 10px 0;"> <table style="margin: 0 auto; border-collapse: collapse;"> <tr> <td style="padding: 0 10px;">O</td> <td style="padding: 0 10px;">D</td> <td style="padding: 0 10px;">I</td> <td style="padding: 0 10px;">S</td> <td style="padding: 0 10px;">Z</td> <td style="padding: 0 10px;">A</td> <td style="padding: 0 10px;">P</td> <td style="padding: 0 10px;">C</td> </tr> <tr> <td style="border: 1px solid black; width: 20px; height: 20px;"></td> <td style="border: 1px solid black; width: 20px; height: 20px;"></td> <td style="border: 1px solid black; width: 20px; height: 20px;"></td> <td style="border: 1px solid black; width: 20px; height: 20px;"></td> <td style="border: 1px solid black; width: 20px; height: 20px;"></td> <td style="border: 1px solid black; width: 20px; height: 20px;"></td> <td style="border: 1px solid black; width: 20px; height: 20px;"></td> <td style="border: 1px solid black; width: 20px; height: 20px;"></td> </tr> </table> </div> | O | D | I | S | Z | A | P | C |  |  |  |  |  |  |  |  |
|                                                                                                                                                                                                                                                                                                                                                                                                                                           | O                                                                                                                                                                                                                                                                                                                                                                                                                                                                                                                                                                                                                                                                                                                                                                                                                                                                                                                                                                                                                                                              | D | I | S | Z | A | P | C |   |  |  |  |  |  |  |  |  |
|                                                                                                                                                                                                                                                                                                                                                                                                                                           |                                                                                                                                                                                                                                                                                                                                                                                                                                                                                                                                                                                                                                                                                                                                                                                                                                                                                                                                                                                                                                                                |   |   |   |   |   |   |   |   |  |  |  |  |  |  |  |  |
| <p>PUSHW pushes a 16-bit word on the stack, and on the x86, PUSHD pushes a 32-bit double-word on the stack.</p> <p>Instruction formats:</p> <div style="display: flex; justify-content: space-around; margin-top: 10px;"> <div style="text-align: center;"> <p>PUSH <i>reg16/reg32</i></p> <p>PUSH <i>mem16/mem32</i></p> </div> <div style="text-align: center;"> <p>PUSH <i>segreg</i></p> <p>PUSH <i>imm16/imm32</i></p> </div> </div> |                                                                                                                                                                                                                                                                                                                                                                                                                                                                                                                                                                                                                                                                                                                                                                                                                                                                                                                                                                                                                                                                |   |   |   |   |   |   |   |   |  |  |  |  |  |  |  |  |

|                                                                                                                                                                                                                                                                                                                                                                                                                                                                                                                                                                                                     |                                                                                                                                                                                                                                                                                                                                                                                                                                                                                                                                                                                                                                                                                                                                                                                                                                                                                                                                                                                                                                                                                                              |   |   |   |   |   |   |   |   |   |  |  |  |  |  |  |   |
|-----------------------------------------------------------------------------------------------------------------------------------------------------------------------------------------------------------------------------------------------------------------------------------------------------------------------------------------------------------------------------------------------------------------------------------------------------------------------------------------------------------------------------------------------------------------------------------------------------|--------------------------------------------------------------------------------------------------------------------------------------------------------------------------------------------------------------------------------------------------------------------------------------------------------------------------------------------------------------------------------------------------------------------------------------------------------------------------------------------------------------------------------------------------------------------------------------------------------------------------------------------------------------------------------------------------------------------------------------------------------------------------------------------------------------------------------------------------------------------------------------------------------------------------------------------------------------------------------------------------------------------------------------------------------------------------------------------------------------|---|---|---|---|---|---|---|---|---|--|--|--|--|--|--|---|
| <b>RCL</b>                                                                                                                                                                                                                                                                                                                                                                                                                                                                                                                                                                                          | <p><b>Rotate Carry Left</b></p> <div style="text-align: center; margin: 10px 0;"> <table style="margin: 0 auto; border-collapse: collapse;"> <tr> <td style="padding: 0 10px;">O</td> <td style="padding: 0 10px;">D</td> <td style="padding: 0 10px;">I</td> <td style="padding: 0 10px;">S</td> <td style="padding: 0 10px;">Z</td> <td style="padding: 0 10px;">A</td> <td style="padding: 0 10px;">P</td> <td style="padding: 0 10px;">C</td> </tr> <tr> <td style="border: 1px solid black; width: 20px; height: 20px; text-align: center;">*</td> <td style="border: 1px solid black; width: 20px; height: 20px;"></td> <td style="border: 1px solid black; width: 20px; height: 20px;"></td> <td style="border: 1px solid black; width: 20px; height: 20px;"></td> <td style="border: 1px solid black; width: 20px; height: 20px;"></td> <td style="border: 1px solid black; width: 20px; height: 20px;"></td> <td style="border: 1px solid black; width: 20px; height: 20px;"></td> <td style="border: 1px solid black; width: 20px; height: 20px; text-align: center;">*</td> </tr> </table> </div> | O | D | I | S | Z | A | P | C | * |  |  |  |  |  |  | * |
|                                                                                                                                                                                                                                                                                                                                                                                                                                                                                                                                                                                                     | O                                                                                                                                                                                                                                                                                                                                                                                                                                                                                                                                                                                                                                                                                                                                                                                                                                                                                                                                                                                                                                                                                                            | D | I | S | Z | A | P | C |   |   |  |  |  |  |  |  |   |
| *                                                                                                                                                                                                                                                                                                                                                                                                                                                                                                                                                                                                   |                                                                                                                                                                                                                                                                                                                                                                                                                                                                                                                                                                                                                                                                                                                                                                                                                                                                                                                                                                                                                                                                                                              |   |   |   |   |   | * |   |   |   |  |  |  |  |  |  |   |
| <p>Rotates the destination operand left, using the source operand to determine the number of rotations. The Carry flag is copied into the lowest bit, and the highest bit is copied into the Carry flag. The <i>imm8</i> operand must be a 1 when using the 8086/8088 processor.</p> <p>Instruction formats:</p> <div style="display: flex; justify-content: space-around; margin-top: 10px;"> <div style="text-align: center;"> <p>RCL <i>reg, imm8</i></p> <p>RCL <i>reg, CL</i></p> </div> <div style="text-align: center;"> <p>RCL <i>mem, imm8</i></p> <p>RCL <i>mem, CL</i></p> </div> </div> |                                                                                                                                                                                                                                                                                                                                                                                                                                                                                                                                                                                                                                                                                                                                                                                                                                                                                                                                                                                                                                                                                                              |   |   |   |   |   |   |   |   |   |  |  |  |  |  |  |   |

|                                                                                                                                                                                                                                                                                                                                                                                                                                                                                                                                                                                                      |                                                                                                                                                                                                                                                                                                                                                                                                                                                                                                                                                                                                                                                                                                                                                                                                                                                                                                                                                                                                                                                                                                               |   |   |   |   |   |   |   |   |   |  |  |  |  |  |  |   |
|------------------------------------------------------------------------------------------------------------------------------------------------------------------------------------------------------------------------------------------------------------------------------------------------------------------------------------------------------------------------------------------------------------------------------------------------------------------------------------------------------------------------------------------------------------------------------------------------------|---------------------------------------------------------------------------------------------------------------------------------------------------------------------------------------------------------------------------------------------------------------------------------------------------------------------------------------------------------------------------------------------------------------------------------------------------------------------------------------------------------------------------------------------------------------------------------------------------------------------------------------------------------------------------------------------------------------------------------------------------------------------------------------------------------------------------------------------------------------------------------------------------------------------------------------------------------------------------------------------------------------------------------------------------------------------------------------------------------------|---|---|---|---|---|---|---|---|---|--|--|--|--|--|--|---|
| <b>RCR</b>                                                                                                                                                                                                                                                                                                                                                                                                                                                                                                                                                                                           | <p><b>Rotate Carry Right</b></p> <div style="text-align: center; margin: 10px 0;"> <table style="margin: 0 auto; border-collapse: collapse;"> <tr> <td style="padding: 0 10px;">O</td> <td style="padding: 0 10px;">D</td> <td style="padding: 0 10px;">I</td> <td style="padding: 0 10px;">S</td> <td style="padding: 0 10px;">Z</td> <td style="padding: 0 10px;">A</td> <td style="padding: 0 10px;">P</td> <td style="padding: 0 10px;">C</td> </tr> <tr> <td style="border: 1px solid black; width: 20px; height: 20px; text-align: center;">*</td> <td style="border: 1px solid black; width: 20px; height: 20px;"></td> <td style="border: 1px solid black; width: 20px; height: 20px;"></td> <td style="border: 1px solid black; width: 20px; height: 20px;"></td> <td style="border: 1px solid black; width: 20px; height: 20px;"></td> <td style="border: 1px solid black; width: 20px; height: 20px;"></td> <td style="border: 1px solid black; width: 20px; height: 20px;"></td> <td style="border: 1px solid black; width: 20px; height: 20px; text-align: center;">*</td> </tr> </table> </div> | O | D | I | S | Z | A | P | C | * |  |  |  |  |  |  | * |
|                                                                                                                                                                                                                                                                                                                                                                                                                                                                                                                                                                                                      | O                                                                                                                                                                                                                                                                                                                                                                                                                                                                                                                                                                                                                                                                                                                                                                                                                                                                                                                                                                                                                                                                                                             | D | I | S | Z | A | P | C |   |   |  |  |  |  |  |  |   |
| *                                                                                                                                                                                                                                                                                                                                                                                                                                                                                                                                                                                                    |                                                                                                                                                                                                                                                                                                                                                                                                                                                                                                                                                                                                                                                                                                                                                                                                                                                                                                                                                                                                                                                                                                               |   |   |   |   |   | * |   |   |   |  |  |  |  |  |  |   |
| <p>Rotates the destination operand right, using the source operand to determine the number of rotations. The Carry flag is copied into the highest bit, and the lowest bit is copied into the Carry flag. The <i>imm8</i> operand must be a 1 when using the 8086/8088 processor.</p> <p>Instruction formats:</p> <div style="display: flex; justify-content: space-around; margin-top: 10px;"> <div style="text-align: center;"> <p>RCR <i>reg, imm8</i></p> <p>RCR <i>reg, CL</i></p> </div> <div style="text-align: center;"> <p>RCR <i>mem, imm8</i></p> <p>RCR <i>mem, CL</i></p> </div> </div> |                                                                                                                                                                                                                                                                                                                                                                                                                                                                                                                                                                                                                                                                                                                                                                                                                                                                                                                                                                                                                                                                                                               |   |   |   |   |   |   |   |   |   |  |  |  |  |  |  |   |



|                                                                                                                                                                                                                                                                                    |                                                                                                                                                                                                                                                                                                                                                                                                                                                                                                                                                                                                                                                                                                                                                                                                                    |   |   |   |   |   |   |   |   |  |  |  |  |  |  |  |  |
|------------------------------------------------------------------------------------------------------------------------------------------------------------------------------------------------------------------------------------------------------------------------------------|--------------------------------------------------------------------------------------------------------------------------------------------------------------------------------------------------------------------------------------------------------------------------------------------------------------------------------------------------------------------------------------------------------------------------------------------------------------------------------------------------------------------------------------------------------------------------------------------------------------------------------------------------------------------------------------------------------------------------------------------------------------------------------------------------------------------|---|---|---|---|---|---|---|---|--|--|--|--|--|--|--|--|
| <b>REP</b>                                                                                                                                                                                                                                                                         | <p><b>Repeat String</b></p> <div style="text-align: center; margin: 10px 0;"> <table style="margin: auto;"> <tr> <td>O</td><td>D</td><td>I</td><td>S</td><td>Z</td><td>A</td><td>P</td><td>C</td> </tr> <tr> <td style="border: 1px solid black; width: 20px; height: 15px;"></td> <td style="border: 1px solid black; width: 20px; height: 15px;"></td> <td style="border: 1px solid black; width: 20px; height: 15px;"></td> <td style="border: 1px solid black; width: 20px; height: 15px;"></td> <td style="border: 1px solid black; width: 20px; height: 15px;"></td> <td style="border: 1px solid black; width: 20px; height: 15px;"></td> <td style="border: 1px solid black; width: 20px; height: 15px;"></td> <td style="border: 1px solid black; width: 20px; height: 15px;"></td> </tr> </table> </div> | O | D | I | S | Z | A | P | C |  |  |  |  |  |  |  |  |
|                                                                                                                                                                                                                                                                                    | O                                                                                                                                                                                                                                                                                                                                                                                                                                                                                                                                                                                                                                                                                                                                                                                                                  | D | I | S | Z | A | P | C |   |  |  |  |  |  |  |  |  |
|                                                                                                                                                                                                                                                                                    |                                                                                                                                                                                                                                                                                                                                                                                                                                                                                                                                                                                                                                                                                                                                                                                                                    |   |   |   |   |   |   |   |   |  |  |  |  |  |  |  |  |
| <p>Repeats a string primitive instruction, using (E)CX as a counter. (E)CX is decremented each time the instruction is repeated, until (E)CX = 0.</p> <p>Format (shown with MOVSB):</p> <p style="text-align: center; margin-left: 40px;"><b>REP MOVSB <i>dest, source</i></b></p> |                                                                                                                                                                                                                                                                                                                                                                                                                                                                                                                                                                                                                                                                                                                                                                                                                    |   |   |   |   |   |   |   |   |  |  |  |  |  |  |  |  |

|                                                                                                                                                                                                                                                                                                                                                                                                                                                                                                                                                                                                                                                                                                                                            |                                                                                                                                                                                                                                                                                                                                                                                                                                                                                                                                                                                                                                                                                                                                                                                                                                  |             |             |       |             |             |      |       |   |       |       |  |      |       |  |       |       |  |
|--------------------------------------------------------------------------------------------------------------------------------------------------------------------------------------------------------------------------------------------------------------------------------------------------------------------------------------------------------------------------------------------------------------------------------------------------------------------------------------------------------------------------------------------------------------------------------------------------------------------------------------------------------------------------------------------------------------------------------------------|----------------------------------------------------------------------------------------------------------------------------------------------------------------------------------------------------------------------------------------------------------------------------------------------------------------------------------------------------------------------------------------------------------------------------------------------------------------------------------------------------------------------------------------------------------------------------------------------------------------------------------------------------------------------------------------------------------------------------------------------------------------------------------------------------------------------------------|-------------|-------------|-------|-------------|-------------|------|-------|---|-------|-------|--|------|-------|--|-------|-------|--|
| <b>REP condition</b>                                                                                                                                                                                                                                                                                                                                                                                                                                                                                                                                                                                                                                                                                                                       | <p><b>Repeat String Conditionally</b></p> <div style="text-align: center; margin: 10px 0;"> <table style="margin: auto;"> <tr> <td>O</td><td>D</td><td>I</td><td>S</td><td>Z</td><td>A</td><td>P</td><td>C</td> </tr> <tr> <td style="border: 1px solid black; width: 20px; height: 15px;"></td> <td style="border: 1px solid black; width: 20px; height: 15px;"></td> <td style="border: 1px solid black; width: 20px; height: 15px;"></td> <td style="border: 1px solid black; width: 20px; height: 15px;"></td> <td style="border: 1px solid black; width: 20px; height: 15px;"></td> <td style="border: 1px solid black; width: 20px; height: 15px;"></td> <td style="border: 1px solid black; width: 20px; height: 15px;"></td> <td style="border: 1px solid black; width: 20px; height: 15px;"></td> </tr> </table> </div> | O           | D           | I     | S           | Z           | A    | P     | C |       |       |  |      |       |  |       |       |  |
|                                                                                                                                                                                                                                                                                                                                                                                                                                                                                                                                                                                                                                                                                                                                            | O                                                                                                                                                                                                                                                                                                                                                                                                                                                                                                                                                                                                                                                                                                                                                                                                                                | D           | I           | S     | Z           | A           | P    | C     |   |       |       |  |      |       |  |       |       |  |
|                                                                                                                                                                                                                                                                                                                                                                                                                                                                                                                                                                                                                                                                                                                                            |                                                                                                                                                                                                                                                                                                                                                                                                                                                                                                                                                                                                                                                                                                                                                                                                                                  |             |             |       |             |             |      |       |   |       |       |  |      |       |  |       |       |  |
| <p>Repeats a string primitive instruction until (E)CX = 0 and while a flag condition is true. REPZ (REPE) repeats while the Zero flag is set, and REPNZ (REPNE) repeats while the Zero flag is clear. Only SCAS and CMPS should be used with REP <i>condition</i>, because they are the only string primitives that modify the Zero flag.</p> <p>Formats used with SCAS:</p> <table style="width: 100%; margin-left: 40px; margin-top: 10px;"> <tr> <td>REPZ</td><td>SCAS</td><td><i>dest</i></td><td>REPNE</td><td>SCAS</td><td><i>dest</i></td> </tr> <tr> <td>REPZ</td><td>SCASB</td><td></td><td>REPNE</td><td>SCASB</td><td></td> </tr> <tr> <td>REPE</td><td>SCASW</td><td></td><td>REPNZ</td><td>SCASW</td><td></td> </tr> </table> | REPZ                                                                                                                                                                                                                                                                                                                                                                                                                                                                                                                                                                                                                                                                                                                                                                                                                             | SCAS        | <i>dest</i> | REPNE | SCAS        | <i>dest</i> | REPZ | SCASB |   | REPNE | SCASB |  | REPE | SCASW |  | REPNZ | SCASW |  |
| REPZ                                                                                                                                                                                                                                                                                                                                                                                                                                                                                                                                                                                                                                                                                                                                       | SCAS                                                                                                                                                                                                                                                                                                                                                                                                                                                                                                                                                                                                                                                                                                                                                                                                                             | <i>dest</i> | REPNE       | SCAS  | <i>dest</i> |             |      |       |   |       |       |  |      |       |  |       |       |  |
| REPZ                                                                                                                                                                                                                                                                                                                                                                                                                                                                                                                                                                                                                                                                                                                                       | SCASB                                                                                                                                                                                                                                                                                                                                                                                                                                                                                                                                                                                                                                                                                                                                                                                                                            |             | REPNE       | SCASB |             |             |      |       |   |       |       |  |      |       |  |       |       |  |
| REPE                                                                                                                                                                                                                                                                                                                                                                                                                                                                                                                                                                                                                                                                                                                                       | SCASW                                                                                                                                                                                                                                                                                                                                                                                                                                                                                                                                                                                                                                                                                                                                                                                                                            |             | REPNZ       | SCASW |             |             |      |       |   |       |       |  |      |       |  |       |       |  |

|                                                                                                                                                                                                                                                                                                                                                                                                                                                                                                                                                                                                                                                                                                           |                                                                                                                                                                                                                                                                                                                                                                                                                                                                                                                                                                                                                                                                                                                                                                                                                            |             |             |      |      |             |      |      |             |  |  |  |  |  |  |  |  |
|-----------------------------------------------------------------------------------------------------------------------------------------------------------------------------------------------------------------------------------------------------------------------------------------------------------------------------------------------------------------------------------------------------------------------------------------------------------------------------------------------------------------------------------------------------------------------------------------------------------------------------------------------------------------------------------------------------------|----------------------------------------------------------------------------------------------------------------------------------------------------------------------------------------------------------------------------------------------------------------------------------------------------------------------------------------------------------------------------------------------------------------------------------------------------------------------------------------------------------------------------------------------------------------------------------------------------------------------------------------------------------------------------------------------------------------------------------------------------------------------------------------------------------------------------|-------------|-------------|------|------|-------------|------|------|-------------|--|--|--|--|--|--|--|--|
| <b>RET,<br/>RETN,<br/>RETF</b>                                                                                                                                                                                                                                                                                                                                                                                                                                                                                                                                                                                                                                                                            | <p><b>Return from Procedure</b></p> <div style="text-align: center; margin: 10px 0;"> <table style="margin: auto;"> <tr> <td>O</td><td>D</td><td>I</td><td>S</td><td>Z</td><td>A</td><td>P</td><td>C</td> </tr> <tr> <td style="border: 1px solid black; width: 20px; height: 15px;"></td> <td style="border: 1px solid black; width: 20px; height: 15px;"></td> <td style="border: 1px solid black; width: 20px; height: 15px;"></td> <td style="border: 1px solid black; width: 20px; height: 15px;"></td> <td style="border: 1px solid black; width: 20px; height: 15px;"></td> <td style="border: 1px solid black; width: 20px; height: 15px;"></td> <td style="border: 1px solid black; width: 20px; height: 15px;"></td> <td style="border: 1px solid black; width: 20px; height: 15px;"></td> </tr> </table> </div> | O           | D           | I    | S    | Z           | A    | P    | C           |  |  |  |  |  |  |  |  |
|                                                                                                                                                                                                                                                                                                                                                                                                                                                                                                                                                                                                                                                                                                           | O                                                                                                                                                                                                                                                                                                                                                                                                                                                                                                                                                                                                                                                                                                                                                                                                                          | D           | I           | S    | Z    | A           | P    | C    |             |  |  |  |  |  |  |  |  |
|                                                                                                                                                                                                                                                                                                                                                                                                                                                                                                                                                                                                                                                                                                           |                                                                                                                                                                                                                                                                                                                                                                                                                                                                                                                                                                                                                                                                                                                                                                                                                            |             |             |      |      |             |      |      |             |  |  |  |  |  |  |  |  |
| <p>Pops a return address from the stack. RETN (return near) pops only the top of the stack into (E)IP. In real-address mode, RETF (return far) pops the stack first into (E)IP and then into CS. RET may be either near or far, depending on the attribute specified or implied by the PROC directive. An optional 8-bit immediate operand tells the CPU to add a value to (E)SP after popping the return address.</p> <p>Instruction formats:</p> <table style="width: 100%; margin-left: 40px; margin-top: 10px;"> <tr> <td>RET</td><td>RET</td><td><i>imm8</i></td> </tr> <tr> <td>RETN</td><td>RETN</td><td><i>imm8</i></td> </tr> <tr> <td>RETF</td><td>RETF</td><td><i>imm8</i></td> </tr> </table> | RET                                                                                                                                                                                                                                                                                                                                                                                                                                                                                                                                                                                                                                                                                                                                                                                                                        | RET         | <i>imm8</i> | RETN | RETN | <i>imm8</i> | RETF | RETF | <i>imm8</i> |  |  |  |  |  |  |  |  |
| RET                                                                                                                                                                                                                                                                                                                                                                                                                                                                                                                                                                                                                                                                                                       | RET                                                                                                                                                                                                                                                                                                                                                                                                                                                                                                                                                                                                                                                                                                                                                                                                                        | <i>imm8</i> |             |      |      |             |      |      |             |  |  |  |  |  |  |  |  |
| RETN                                                                                                                                                                                                                                                                                                                                                                                                                                                                                                                                                                                                                                                                                                      | RETN                                                                                                                                                                                                                                                                                                                                                                                                                                                                                                                                                                                                                                                                                                                                                                                                                       | <i>imm8</i> |             |      |      |             |      |      |             |  |  |  |  |  |  |  |  |
| RETF                                                                                                                                                                                                                                                                                                                                                                                                                                                                                                                                                                                                                                                                                                      | RETF                                                                                                                                                                                                                                                                                                                                                                                                                                                                                                                                                                                                                                                                                                                                                                                                                       | <i>imm8</i> |             |      |      |             |      |      |             |  |  |  |  |  |  |  |  |

|                                                                                                                                                                                                                                                                                                                                                                                                                                                                                                                                                               |                                                                                                                                                                                                                                                                                                                                                                                                                                                                                                                                                                                                                                                                                                                                                                                                                                                                                                                                                      |                      |                    |                    |   |   |   |   |   |   |  |  |  |  |  |  |   |
|---------------------------------------------------------------------------------------------------------------------------------------------------------------------------------------------------------------------------------------------------------------------------------------------------------------------------------------------------------------------------------------------------------------------------------------------------------------------------------------------------------------------------------------------------------------|------------------------------------------------------------------------------------------------------------------------------------------------------------------------------------------------------------------------------------------------------------------------------------------------------------------------------------------------------------------------------------------------------------------------------------------------------------------------------------------------------------------------------------------------------------------------------------------------------------------------------------------------------------------------------------------------------------------------------------------------------------------------------------------------------------------------------------------------------------------------------------------------------------------------------------------------------|----------------------|--------------------|--------------------|---|---|---|---|---|---|--|--|--|--|--|--|---|
| <b>ROL</b>                                                                                                                                                                                                                                                                                                                                                                                                                                                                                                                                                    | <p><b>Rotate Left</b></p> <table style="margin-left: auto; margin-right: auto; border-collapse: collapse;"> <tr> <td style="padding: 0 10px;">O</td> <td style="padding: 0 10px;">D</td> <td style="padding: 0 10px;">I</td> <td style="padding: 0 10px;">S</td> <td style="padding: 0 10px;">Z</td> <td style="padding: 0 10px;">A</td> <td style="padding: 0 10px;">P</td> <td style="padding: 0 10px;">C</td> </tr> <tr> <td style="border: 1px solid black; text-align: center; width: 20px;">*</td> <td style="border: 1px solid black; width: 20px;"></td> <td style="border: 1px solid black; width: 20px;"></td> <td style="border: 1px solid black; width: 20px;"></td> <td style="border: 1px solid black; width: 20px;"></td> <td style="border: 1px solid black; width: 20px;"></td> <td style="border: 1px solid black; width: 20px;"></td> <td style="border: 1px solid black; text-align: center; width: 20px;">*</td> </tr> </table> | O                    | D                  | I                  | S | Z | A | P | C | * |  |  |  |  |  |  | * |
|                                                                                                                                                                                                                                                                                                                                                                                                                                                                                                                                                               | O                                                                                                                                                                                                                                                                                                                                                                                                                                                                                                                                                                                                                                                                                                                                                                                                                                                                                                                                                    | D                    | I                  | S                  | Z | A | P | C |   |   |  |  |  |  |  |  |   |
| *                                                                                                                                                                                                                                                                                                                                                                                                                                                                                                                                                             |                                                                                                                                                                                                                                                                                                                                                                                                                                                                                                                                                                                                                                                                                                                                                                                                                                                                                                                                                      |                      |                    |                    |   |   | * |   |   |   |  |  |  |  |  |  |   |
| <p>Rotates the destination operand left, using the source operand to determine the number of rotations. The highest bit is copied into the Carry flag and moved into the lowest bit position. The <i>imm8</i> operand must be a 1 when using the 8086/8088 processor.</p> <p>Instruction formats:</p> <table style="width: 100%; border: none;"> <tr> <td style="padding-right: 40px;">ROL <i>reg, imm8</i></td> <td>ROL <i>mem, imm8</i></td> </tr> <tr> <td style="padding-right: 40px;">ROL <i>reg, CL</i></td> <td>ROL <i>mem, CL</i></td> </tr> </table> | ROL <i>reg, imm8</i>                                                                                                                                                                                                                                                                                                                                                                                                                                                                                                                                                                                                                                                                                                                                                                                                                                                                                                                                 | ROL <i>mem, imm8</i> | ROL <i>reg, CL</i> | ROL <i>mem, CL</i> |   |   |   |   |   |   |  |  |  |  |  |  |   |
| ROL <i>reg, imm8</i>                                                                                                                                                                                                                                                                                                                                                                                                                                                                                                                                          | ROL <i>mem, imm8</i>                                                                                                                                                                                                                                                                                                                                                                                                                                                                                                                                                                                                                                                                                                                                                                                                                                                                                                                                 |                      |                    |                    |   |   |   |   |   |   |  |  |  |  |  |  |   |
| ROL <i>reg, CL</i>                                                                                                                                                                                                                                                                                                                                                                                                                                                                                                                                            | ROL <i>mem, CL</i>                                                                                                                                                                                                                                                                                                                                                                                                                                                                                                                                                                                                                                                                                                                                                                                                                                                                                                                                   |                      |                    |                    |   |   |   |   |   |   |  |  |  |  |  |  |   |

|                                                                                                                                                                                                                                                                                                                                                                                                                                                                                                                                                          |                                                                                                                                                                                                                                                                                                                                                                                                                                                                                                                                                                                                                                                                                                                                                                                                                                                                                                                                                       |                      |                    |                    |   |   |   |   |   |   |  |  |  |  |  |  |   |
|----------------------------------------------------------------------------------------------------------------------------------------------------------------------------------------------------------------------------------------------------------------------------------------------------------------------------------------------------------------------------------------------------------------------------------------------------------------------------------------------------------------------------------------------------------|-------------------------------------------------------------------------------------------------------------------------------------------------------------------------------------------------------------------------------------------------------------------------------------------------------------------------------------------------------------------------------------------------------------------------------------------------------------------------------------------------------------------------------------------------------------------------------------------------------------------------------------------------------------------------------------------------------------------------------------------------------------------------------------------------------------------------------------------------------------------------------------------------------------------------------------------------------|----------------------|--------------------|--------------------|---|---|---|---|---|---|--|--|--|--|--|--|---|
| <b>ROR</b>                                                                                                                                                                                                                                                                                                                                                                                                                                                                                                                                               | <p><b>Rotate Right</b></p> <table style="margin-left: auto; margin-right: auto; border-collapse: collapse;"> <tr> <td style="padding: 0 10px;">O</td> <td style="padding: 0 10px;">D</td> <td style="padding: 0 10px;">I</td> <td style="padding: 0 10px;">S</td> <td style="padding: 0 10px;">Z</td> <td style="padding: 0 10px;">A</td> <td style="padding: 0 10px;">P</td> <td style="padding: 0 10px;">C</td> </tr> <tr> <td style="border: 1px solid black; text-align: center; width: 20px;">*</td> <td style="border: 1px solid black; width: 20px;"></td> <td style="border: 1px solid black; width: 20px;"></td> <td style="border: 1px solid black; width: 20px;"></td> <td style="border: 1px solid black; width: 20px;"></td> <td style="border: 1px solid black; width: 20px;"></td> <td style="border: 1px solid black; width: 20px;"></td> <td style="border: 1px solid black; text-align: center; width: 20px;">*</td> </tr> </table> | O                    | D                  | I                  | S | Z | A | P | C | * |  |  |  |  |  |  | * |
|                                                                                                                                                                                                                                                                                                                                                                                                                                                                                                                                                          | O                                                                                                                                                                                                                                                                                                                                                                                                                                                                                                                                                                                                                                                                                                                                                                                                                                                                                                                                                     | D                    | I                  | S                  | Z | A | P | C |   |   |  |  |  |  |  |  |   |
| *                                                                                                                                                                                                                                                                                                                                                                                                                                                                                                                                                        |                                                                                                                                                                                                                                                                                                                                                                                                                                                                                                                                                                                                                                                                                                                                                                                                                                                                                                                                                       |                      |                    |                    |   |   | * |   |   |   |  |  |  |  |  |  |   |
| <p>Rotates the destination operand right, using the source operand to determine the number of rotations. The lowest bit is copied into both the Carry flag and the highest bit position. The <i>imm8</i> operand must be a 1 when using the 8086/8088 processor.</p> <p>Instruction formats:</p> <table style="width: 100%; border: none;"> <tr> <td style="padding-right: 40px;">ROR <i>reg, imm8</i></td> <td>ROR <i>mem, imm8</i></td> </tr> <tr> <td style="padding-right: 40px;">ROR <i>reg, CL</i></td> <td>ROR <i>mem, CL</i></td> </tr> </table> | ROR <i>reg, imm8</i>                                                                                                                                                                                                                                                                                                                                                                                                                                                                                                                                                                                                                                                                                                                                                                                                                                                                                                                                  | ROR <i>mem, imm8</i> | ROR <i>reg, CL</i> | ROR <i>mem, CL</i> |   |   |   |   |   |   |  |  |  |  |  |  |   |
| ROR <i>reg, imm8</i>                                                                                                                                                                                                                                                                                                                                                                                                                                                                                                                                     | ROR <i>mem, imm8</i>                                                                                                                                                                                                                                                                                                                                                                                                                                                                                                                                                                                                                                                                                                                                                                                                                                                                                                                                  |                      |                    |                    |   |   |   |   |   |   |  |  |  |  |  |  |   |
| ROR <i>reg, CL</i>                                                                                                                                                                                                                                                                                                                                                                                                                                                                                                                                       | ROR <i>mem, CL</i>                                                                                                                                                                                                                                                                                                                                                                                                                                                                                                                                                                                                                                                                                                                                                                                                                                                                                                                                    |                      |                    |                    |   |   |   |   |   |   |  |  |  |  |  |  |   |

|                                                                                                                                  |                                                                                                                                                                                                                                                                                                                                                                                                                                                                                                                                                                                                                                                                                                                                                                                                                                                                                                                                                                                                                             |   |   |   |   |   |   |   |   |  |  |  |   |   |   |   |   |
|----------------------------------------------------------------------------------------------------------------------------------|-----------------------------------------------------------------------------------------------------------------------------------------------------------------------------------------------------------------------------------------------------------------------------------------------------------------------------------------------------------------------------------------------------------------------------------------------------------------------------------------------------------------------------------------------------------------------------------------------------------------------------------------------------------------------------------------------------------------------------------------------------------------------------------------------------------------------------------------------------------------------------------------------------------------------------------------------------------------------------------------------------------------------------|---|---|---|---|---|---|---|---|--|--|--|---|---|---|---|---|
| <b>SAHF</b>                                                                                                                      | <p><b>Store AH into Flags</b></p> <table style="margin-left: auto; margin-right: auto; border-collapse: collapse;"> <tr> <td style="padding: 0 10px;">O</td> <td style="padding: 0 10px;">D</td> <td style="padding: 0 10px;">I</td> <td style="padding: 0 10px;">S</td> <td style="padding: 0 10px;">Z</td> <td style="padding: 0 10px;">A</td> <td style="padding: 0 10px;">P</td> <td style="padding: 0 10px;">C</td> </tr> <tr> <td style="border: 1px solid black; width: 20px;"></td> <td style="border: 1px solid black; width: 20px;"></td> <td style="border: 1px solid black; width: 20px;"></td> <td style="border: 1px solid black; text-align: center; width: 20px;">*</td> <td style="border: 1px solid black; text-align: center; width: 20px;">*</td> <td style="border: 1px solid black; text-align: center; width: 20px;">*</td> <td style="border: 1px solid black; text-align: center; width: 20px;">*</td> <td style="border: 1px solid black; text-align: center; width: 20px;">*</td> </tr> </table> | O | D | I | S | Z | A | P | C |  |  |  | * | * | * | * | * |
|                                                                                                                                  | O                                                                                                                                                                                                                                                                                                                                                                                                                                                                                                                                                                                                                                                                                                                                                                                                                                                                                                                                                                                                                           | D | I | S | Z | A | P | C |   |  |  |  |   |   |   |   |   |
|                                                                                                                                  |                                                                                                                                                                                                                                                                                                                                                                                                                                                                                                                                                                                                                                                                                                                                                                                                                                                                                                                                                                                                                             |   | * | * | * | * | * |   |   |  |  |  |   |   |   |   |   |
| <p>Copies AH into bits 0 through 7 of the Flags register.</p> <p>Instruction format:</p> <p style="text-align: center;">SAHF</p> |                                                                                                                                                                                                                                                                                                                                                                                                                                                                                                                                                                                                                                                                                                                                                                                                                                                                                                                                                                                                                             |   |   |   |   |   |   |   |   |  |  |  |   |   |   |   |   |

|                                                                                                                                                                                                                                                                                                                                                                                                                                                                                                                                                                                 |                                                                                                                                                                                                                                                                                                                                                                                                                                                                                                                                                                                                                                                                                                                                                                                                                                                                                                                                                                                                                                                    |                      |                    |                    |   |   |   |   |   |   |  |  |   |   |   |   |   |
|---------------------------------------------------------------------------------------------------------------------------------------------------------------------------------------------------------------------------------------------------------------------------------------------------------------------------------------------------------------------------------------------------------------------------------------------------------------------------------------------------------------------------------------------------------------------------------|----------------------------------------------------------------------------------------------------------------------------------------------------------------------------------------------------------------------------------------------------------------------------------------------------------------------------------------------------------------------------------------------------------------------------------------------------------------------------------------------------------------------------------------------------------------------------------------------------------------------------------------------------------------------------------------------------------------------------------------------------------------------------------------------------------------------------------------------------------------------------------------------------------------------------------------------------------------------------------------------------------------------------------------------------|----------------------|--------------------|--------------------|---|---|---|---|---|---|--|--|---|---|---|---|---|
| <b>SAL</b>                                                                                                                                                                                                                                                                                                                                                                                                                                                                                                                                                                      | <p><b>Shift Arithmetic Left</b></p> <table style="margin-left: auto; margin-right: auto; border-collapse: collapse;"> <tr> <td style="padding: 0 10px;">O</td> <td style="padding: 0 10px;">D</td> <td style="padding: 0 10px;">I</td> <td style="padding: 0 10px;">S</td> <td style="padding: 0 10px;">Z</td> <td style="padding: 0 10px;">A</td> <td style="padding: 0 10px;">P</td> <td style="padding: 0 10px;">C</td> </tr> <tr> <td style="border: 1px solid black; text-align: center; width: 20px;">*</td> <td style="border: 1px solid black; width: 20px;"></td> <td style="border: 1px solid black; width: 20px;"></td> <td style="border: 1px solid black; text-align: center; width: 20px;">*</td> <td style="border: 1px solid black; text-align: center; width: 20px;">*</td> <td style="border: 1px solid black; text-align: center; width: 20px;">?</td> <td style="border: 1px solid black; text-align: center; width: 20px;">*</td> <td style="border: 1px solid black; text-align: center; width: 20px;">*</td> </tr> </table> | O                    | D                  | I                  | S | Z | A | P | C | * |  |  | * | * | ? | * | * |
|                                                                                                                                                                                                                                                                                                                                                                                                                                                                                                                                                                                 | O                                                                                                                                                                                                                                                                                                                                                                                                                                                                                                                                                                                                                                                                                                                                                                                                                                                                                                                                                                                                                                                  | D                    | I                  | S                  | Z | A | P | C |   |   |  |  |   |   |   |   |   |
| *                                                                                                                                                                                                                                                                                                                                                                                                                                                                                                                                                                               |                                                                                                                                                                                                                                                                                                                                                                                                                                                                                                                                                                                                                                                                                                                                                                                                                                                                                                                                                                                                                                                    |                      | *                  | *                  | ? | * | * |   |   |   |  |  |   |   |   |   |   |
| <p>Shifts each bit in the destination operand to the left, using the source operand to determine the number of shifts. The highest bit is copied into the Carry flag, and the lowest bit is filled with a zero. The <i>imm8</i> operand must be a 1 when using the 8086/8088 processor.</p> <p>Instruction formats:</p> <table style="width: 100%; border: none;"> <tr> <td style="padding-right: 40px;">SAL <i>reg, imm8</i></td> <td>SAL <i>mem, imm8</i></td> </tr> <tr> <td style="padding-right: 40px;">SAL <i>reg, CL</i></td> <td>SAL <i>mem, CL</i></td> </tr> </table> | SAL <i>reg, imm8</i>                                                                                                                                                                                                                                                                                                                                                                                                                                                                                                                                                                                                                                                                                                                                                                                                                                                                                                                                                                                                                               | SAL <i>mem, imm8</i> | SAL <i>reg, CL</i> | SAL <i>mem, CL</i> |   |   |   |   |   |   |  |  |   |   |   |   |   |
| SAL <i>reg, imm8</i>                                                                                                                                                                                                                                                                                                                                                                                                                                                                                                                                                            | SAL <i>mem, imm8</i>                                                                                                                                                                                                                                                                                                                                                                                                                                                                                                                                                                                                                                                                                                                                                                                                                                                                                                                                                                                                                               |                      |                    |                    |   |   |   |   |   |   |  |  |   |   |   |   |   |
| SAL <i>reg, CL</i>                                                                                                                                                                                                                                                                                                                                                                                                                                                                                                                                                              | SAL <i>mem, CL</i>                                                                                                                                                                                                                                                                                                                                                                                                                                                                                                                                                                                                                                                                                                                                                                                                                                                                                                                                                                                                                                 |                      |                    |                    |   |   |   |   |   |   |  |  |   |   |   |   |   |

|                      |                                                                                                                                                                                                                                                                                                                                                                                                                                                                                                                                                                                                                                                                                                                                                                                                                                                                                                                                                                                                                                                                                                                                                                                                                                                                                                                                                                                                                                                                 |   |   |   |   |   |   |   |   |   |  |  |   |   |   |   |   |                      |                      |                    |
|----------------------|-----------------------------------------------------------------------------------------------------------------------------------------------------------------------------------------------------------------------------------------------------------------------------------------------------------------------------------------------------------------------------------------------------------------------------------------------------------------------------------------------------------------------------------------------------------------------------------------------------------------------------------------------------------------------------------------------------------------------------------------------------------------------------------------------------------------------------------------------------------------------------------------------------------------------------------------------------------------------------------------------------------------------------------------------------------------------------------------------------------------------------------------------------------------------------------------------------------------------------------------------------------------------------------------------------------------------------------------------------------------------------------------------------------------------------------------------------------------|---|---|---|---|---|---|---|---|---|--|--|---|---|---|---|---|----------------------|----------------------|--------------------|
| <b>SAR</b>           | <b>Shift Arithmetic Right</b>                                                                                                                                                                                                                                                                                                                                                                                                                                                                                                                                                                                                                                                                                                                                                                                                                                                                                                                                                                                                                                                                                                                                                                                                                                                                                                                                                                                                                                   |   |   |   |   |   |   |   |   |   |  |  |   |   |   |   |   |                      |                      |                    |
|                      | <table style="margin-left: auto; margin-right: auto;"> <tr> <td style="text-align: center;">O</td> <td style="text-align: center;">D</td> <td style="text-align: center;">I</td> <td style="text-align: center;">S</td> <td style="text-align: center;">Z</td> <td style="text-align: center;">A</td> <td style="text-align: center;">P</td> <td style="text-align: center;">C</td> </tr> <tr> <td style="text-align: center;">*</td> <td style="text-align: center;"></td> <td style="text-align: center;"></td> <td style="text-align: center;">*</td> <td style="text-align: center;">*</td> <td style="text-align: center;">?</td> <td style="text-align: center;">*</td> <td style="text-align: center;">*</td> </tr> </table> <p>Shifts each bit in the destination operand to the right, using the source operand to determine the number of shifts. The lowest bit is copied into the Carry flag, and the highest bit retains its previous value. This shift is often used with signed operands because it preserves the number's sign. The <i>imm8</i> operand must be a 1 when using the 8086/8088 processor.</p> <p>Instruction formats:</p> <table style="width: 100%; border: none;"> <tr> <td style="text-align: left;">SAR <i>reg, imm8</i></td> <td style="text-align: right;">SAR <i>mem, imm8</i></td> </tr> <tr> <td style="text-align: left;">SAR <i>reg, CL</i></td> <td style="text-align: right;">SAR <i>mem, CL</i></td> </tr> </table> | O | D | I | S | Z | A | P | C | * |  |  | * | * | ? | * | * | SAR <i>reg, imm8</i> | SAR <i>mem, imm8</i> | SAR <i>reg, CL</i> |
| O                    | D                                                                                                                                                                                                                                                                                                                                                                                                                                                                                                                                                                                                                                                                                                                                                                                                                                                                                                                                                                                                                                                                                                                                                                                                                                                                                                                                                                                                                                                               | I | S | Z | A | P | C |   |   |   |  |  |   |   |   |   |   |                      |                      |                    |
| *                    |                                                                                                                                                                                                                                                                                                                                                                                                                                                                                                                                                                                                                                                                                                                                                                                                                                                                                                                                                                                                                                                                                                                                                                                                                                                                                                                                                                                                                                                                 |   | * | * | ? | * | * |   |   |   |  |  |   |   |   |   |   |                      |                      |                    |
| SAR <i>reg, imm8</i> | SAR <i>mem, imm8</i>                                                                                                                                                                                                                                                                                                                                                                                                                                                                                                                                                                                                                                                                                                                                                                                                                                                                                                                                                                                                                                                                                                                                                                                                                                                                                                                                                                                                                                            |   |   |   |   |   |   |   |   |   |  |  |   |   |   |   |   |                      |                      |                    |
| SAR <i>reg, CL</i>   | SAR <i>mem, CL</i>                                                                                                                                                                                                                                                                                                                                                                                                                                                                                                                                                                                                                                                                                                                                                                                                                                                                                                                                                                                                                                                                                                                                                                                                                                                                                                                                                                                                                                              |   |   |   |   |   |   |   |   |   |  |  |   |   |   |   |   |                      |                      |                    |

|                     |                                                                                                                                                                                                                                                                                                                                                                                                                                                                                                                                                                                                                                                                                                                                                                                                                                                                                                                                                                                                                                                                                                                                                                                                                                                                              |   |   |   |   |   |   |   |   |   |  |  |   |   |   |   |   |                     |                     |                     |                     |                     |
|---------------------|------------------------------------------------------------------------------------------------------------------------------------------------------------------------------------------------------------------------------------------------------------------------------------------------------------------------------------------------------------------------------------------------------------------------------------------------------------------------------------------------------------------------------------------------------------------------------------------------------------------------------------------------------------------------------------------------------------------------------------------------------------------------------------------------------------------------------------------------------------------------------------------------------------------------------------------------------------------------------------------------------------------------------------------------------------------------------------------------------------------------------------------------------------------------------------------------------------------------------------------------------------------------------|---|---|---|---|---|---|---|---|---|--|--|---|---|---|---|---|---------------------|---------------------|---------------------|---------------------|---------------------|
| <b>SBB</b>          | <b>Subtract with Borrow</b>                                                                                                                                                                                                                                                                                                                                                                                                                                                                                                                                                                                                                                                                                                                                                                                                                                                                                                                                                                                                                                                                                                                                                                                                                                                  |   |   |   |   |   |   |   |   |   |  |  |   |   |   |   |   |                     |                     |                     |                     |                     |
|                     | <table style="margin-left: auto; margin-right: auto;"> <tr> <td style="text-align: center;">O</td> <td style="text-align: center;">D</td> <td style="text-align: center;">I</td> <td style="text-align: center;">S</td> <td style="text-align: center;">Z</td> <td style="text-align: center;">A</td> <td style="text-align: center;">P</td> <td style="text-align: center;">C</td> </tr> <tr> <td style="text-align: center;">*</td> <td style="text-align: center;"></td> <td style="text-align: center;"></td> <td style="text-align: center;">*</td> <td style="text-align: center;">*</td> <td style="text-align: center;">*</td> <td style="text-align: center;">*</td> <td style="text-align: center;">*</td> </tr> </table> <p>Subtracts the source operand from the destination operand and then subtracts the Carry flag from the destination.</p> <p>Instruction formats:</p> <table style="width: 100%; border: none;"> <tr> <td style="text-align: left;">SBB <i>reg, reg</i></td> <td style="text-align: right;">SBB <i>reg, imm</i></td> </tr> <tr> <td style="text-align: left;">SBB <i>mem, reg</i></td> <td style="text-align: right;">SBB <i>mem, imm</i></td> </tr> <tr> <td style="text-align: left;">SBB <i>reg, mem</i></td> <td></td> </tr> </table> | O | D | I | S | Z | A | P | C | * |  |  | * | * | * | * | * | SBB <i>reg, reg</i> | SBB <i>reg, imm</i> | SBB <i>mem, reg</i> | SBB <i>mem, imm</i> | SBB <i>reg, mem</i> |
| O                   | D                                                                                                                                                                                                                                                                                                                                                                                                                                                                                                                                                                                                                                                                                                                                                                                                                                                                                                                                                                                                                                                                                                                                                                                                                                                                            | I | S | Z | A | P | C |   |   |   |  |  |   |   |   |   |   |                     |                     |                     |                     |                     |
| *                   |                                                                                                                                                                                                                                                                                                                                                                                                                                                                                                                                                                                                                                                                                                                                                                                                                                                                                                                                                                                                                                                                                                                                                                                                                                                                              |   | * | * | * | * | * |   |   |   |  |  |   |   |   |   |   |                     |                     |                     |                     |                     |
| SBB <i>reg, reg</i> | SBB <i>reg, imm</i>                                                                                                                                                                                                                                                                                                                                                                                                                                                                                                                                                                                                                                                                                                                                                                                                                                                                                                                                                                                                                                                                                                                                                                                                                                                          |   |   |   |   |   |   |   |   |   |  |  |   |   |   |   |   |                     |                     |                     |                     |                     |
| SBB <i>mem, reg</i> | SBB <i>mem, imm</i>                                                                                                                                                                                                                                                                                                                                                                                                                                                                                                                                                                                                                                                                                                                                                                                                                                                                                                                                                                                                                                                                                                                                                                                                                                                          |   |   |   |   |   |   |   |   |   |  |  |   |   |   |   |   |                     |                     |                     |                     |                     |
| SBB <i>reg, mem</i> |                                                                                                                                                                                                                                                                                                                                                                                                                                                                                                                                                                                                                                                                                                                                                                                                                                                                                                                                                                                                                                                                                                                                                                                                                                                                              |   |   |   |   |   |   |   |   |   |  |  |   |   |   |   |   |                     |                     |                     |                     |                     |

|                                              |                                                                                                                                                                                                                                                                                                                                                                                                                                                                                                                                                                                                                                                                                                                                                                                                                                                                                                                                                                                                                                                                                                                                                                                                                                                                                                                                                                                                                                                                                                                                                                                              |   |   |   |   |   |   |   |   |   |  |  |   |   |   |   |   |       |       |       |  |                  |  |                      |
|----------------------------------------------|----------------------------------------------------------------------------------------------------------------------------------------------------------------------------------------------------------------------------------------------------------------------------------------------------------------------------------------------------------------------------------------------------------------------------------------------------------------------------------------------------------------------------------------------------------------------------------------------------------------------------------------------------------------------------------------------------------------------------------------------------------------------------------------------------------------------------------------------------------------------------------------------------------------------------------------------------------------------------------------------------------------------------------------------------------------------------------------------------------------------------------------------------------------------------------------------------------------------------------------------------------------------------------------------------------------------------------------------------------------------------------------------------------------------------------------------------------------------------------------------------------------------------------------------------------------------------------------------|---|---|---|---|---|---|---|---|---|--|--|---|---|---|---|---|-------|-------|-------|--|------------------|--|----------------------|
| <b>SCAS,<br/>SCASB,<br/>SCASW,<br/>SCASD</b> | <b>Scan String</b>                                                                                                                                                                                                                                                                                                                                                                                                                                                                                                                                                                                                                                                                                                                                                                                                                                                                                                                                                                                                                                                                                                                                                                                                                                                                                                                                                                                                                                                                                                                                                                           |   |   |   |   |   |   |   |   |   |  |  |   |   |   |   |   |       |       |       |  |                  |  |                      |
|                                              | <table style="margin-left: auto; margin-right: auto;"> <tr> <td style="text-align: center;">O</td> <td style="text-align: center;">D</td> <td style="text-align: center;">I</td> <td style="text-align: center;">S</td> <td style="text-align: center;">Z</td> <td style="text-align: center;">A</td> <td style="text-align: center;">P</td> <td style="text-align: center;">C</td> </tr> <tr> <td style="text-align: center;">*</td> <td style="text-align: center;"></td> <td style="text-align: center;"></td> <td style="text-align: center;">*</td> <td style="text-align: center;">*</td> <td style="text-align: center;">*</td> <td style="text-align: center;">*</td> <td style="text-align: center;">*</td> </tr> </table> <p>Scans a string in memory pointed to by ES:(E)DI for a value that matches the accumulator. SCAS requires the operands to be specified. SCASB scans for an 8-bit value matching AL, SCASW scans for a 16-bit value matching AX, and SCASD scans for a 32-bit value matching EAX. (E)DI is increased or decreased according to the operand size and the status of the direction flag. If DF = 1, (E)DI is decreased; if DF = 0, (E)DI is increased.</p> <p>Instruction formats:</p> <table style="width: 100%; border: none;"> <tr> <td style="text-align: left;">SCASB</td> <td style="text-align: right;">SCASW</td> </tr> <tr> <td style="text-align: left;">SCASD</td> <td></td> </tr> <tr> <td style="text-align: left;">SCAS <i>dest</i></td> <td></td> </tr> <tr> <td style="text-align: left;">SCAS ES:<i>dest</i></td> <td></td> </tr> </table> | O | D | I | S | Z | A | P | C | * |  |  | * | * | * | * | * | SCASB | SCASW | SCASD |  | SCAS <i>dest</i> |  | SCAS ES: <i>dest</i> |
| O                                            | D                                                                                                                                                                                                                                                                                                                                                                                                                                                                                                                                                                                                                                                                                                                                                                                                                                                                                                                                                                                                                                                                                                                                                                                                                                                                                                                                                                                                                                                                                                                                                                                            | I | S | Z | A | P | C |   |   |   |  |  |   |   |   |   |   |       |       |       |  |                  |  |                      |
| *                                            |                                                                                                                                                                                                                                                                                                                                                                                                                                                                                                                                                                                                                                                                                                                                                                                                                                                                                                                                                                                                                                                                                                                                                                                                                                                                                                                                                                                                                                                                                                                                                                                              |   | * | * | * | * | * |   |   |   |  |  |   |   |   |   |   |       |       |       |  |                  |  |                      |
| SCASB                                        | SCASW                                                                                                                                                                                                                                                                                                                                                                                                                                                                                                                                                                                                                                                                                                                                                                                                                                                                                                                                                                                                                                                                                                                                                                                                                                                                                                                                                                                                                                                                                                                                                                                        |   |   |   |   |   |   |   |   |   |  |  |   |   |   |   |   |       |       |       |  |                  |  |                      |
| SCASD                                        |                                                                                                                                                                                                                                                                                                                                                                                                                                                                                                                                                                                                                                                                                                                                                                                                                                                                                                                                                                                                                                                                                                                                                                                                                                                                                                                                                                                                                                                                                                                                                                                              |   |   |   |   |   |   |   |   |   |  |  |   |   |   |   |   |       |       |       |  |                  |  |                      |
| SCAS <i>dest</i>                             |                                                                                                                                                                                                                                                                                                                                                                                                                                                                                                                                                                                                                                                                                                                                                                                                                                                                                                                                                                                                                                                                                                                                                                                                                                                                                                                                                                                                                                                                                                                                                                                              |   |   |   |   |   |   |   |   |   |  |  |   |   |   |   |   |       |       |       |  |                  |  |                      |
| SCAS ES: <i>dest</i>                         |                                                                                                                                                                                                                                                                                                                                                                                                                                                                                                                                                                                                                                                                                                                                                                                                                                                                                                                                                                                                                                                                                                                                                                                                                                                                                                                                                                                                                                                                                                                                                                                              |   |   |   |   |   |   |   |   |   |  |  |   |   |   |   |   |       |       |       |  |                  |  |                      |

|                                                                                                                                                                                                                                                                                                                                                                                                                                                                   |                                                                                                                                                                                                                                                                                                                                                                                                                                                                                                                                                                                                                                                                                                                                                                                                                        |   |   |   |   |   |   |   |   |  |  |  |  |  |  |  |  |
|-------------------------------------------------------------------------------------------------------------------------------------------------------------------------------------------------------------------------------------------------------------------------------------------------------------------------------------------------------------------------------------------------------------------------------------------------------------------|------------------------------------------------------------------------------------------------------------------------------------------------------------------------------------------------------------------------------------------------------------------------------------------------------------------------------------------------------------------------------------------------------------------------------------------------------------------------------------------------------------------------------------------------------------------------------------------------------------------------------------------------------------------------------------------------------------------------------------------------------------------------------------------------------------------------|---|---|---|---|---|---|---|---|--|--|--|--|--|--|--|--|
| <b>SETcondition</b>                                                                                                                                                                                                                                                                                                                                                                                                                                               | <p><b>Set Conditionally</b></p> <div style="text-align: center; margin: 10px 0;"> <table style="margin: auto;"> <tr> <td>O</td><td>D</td><td>I</td><td>S</td><td>Z</td><td>A</td><td>P</td><td>C</td> </tr> <tr> <td style="border: 1px solid black; width: 20px; height: 15px;"></td> <td style="border: 1px solid black; width: 20px; height: 15px;"></td> <td style="border: 1px solid black; width: 20px; height: 15px;"></td> <td style="border: 1px solid black; width: 20px; height: 15px;"></td> <td style="border: 1px solid black; width: 20px; height: 15px;"></td> <td style="border: 1px solid black; width: 20px; height: 15px;"></td> <td style="border: 1px solid black; width: 20px; height: 15px;"></td> <td style="border: 1px solid black; width: 20px; height: 15px;"></td> </tr> </table> </div> | O | D | I | S | Z | A | P | C |  |  |  |  |  |  |  |  |
|                                                                                                                                                                                                                                                                                                                                                                                                                                                                   | O                                                                                                                                                                                                                                                                                                                                                                                                                                                                                                                                                                                                                                                                                                                                                                                                                      | D | I | S | Z | A | P | C |   |  |  |  |  |  |  |  |  |
|                                                                                                                                                                                                                                                                                                                                                                                                                                                                   |                                                                                                                                                                                                                                                                                                                                                                                                                                                                                                                                                                                                                                                                                                                                                                                                                        |   |   |   |   |   |   |   |   |  |  |  |  |  |  |  |  |
| <p>If the given flag condition is true, the byte specified by the destination operand is assigned the value 1. If the flag condition is false, the destination is assigned a value of 0. The possible values for <i>condition</i> were listed in Table B-2.</p> <p>Instruction formats:</p> <div style="display: flex; justify-content: space-between; margin-top: 10px;"> <span><b>SETcond</b> <i>reg8</i></span> <span><b>SETcond</b> <i>mem8</i></span> </div> |                                                                                                                                                                                                                                                                                                                                                                                                                                                                                                                                                                                                                                                                                                                                                                                                                        |   |   |   |   |   |   |   |   |  |  |  |  |  |  |  |  |

|                                                                                                                                                                                                                                                                                                                                                                                                                                                                                                                                                                                                                                                                                       |                                                                                                                                                                                                                                                                                                                                                                                                                                                                                                                                                                                                                                                                                                                                                                                                                                                                                                                                               |   |   |   |   |   |   |   |   |   |  |  |   |   |   |   |   |
|---------------------------------------------------------------------------------------------------------------------------------------------------------------------------------------------------------------------------------------------------------------------------------------------------------------------------------------------------------------------------------------------------------------------------------------------------------------------------------------------------------------------------------------------------------------------------------------------------------------------------------------------------------------------------------------|-----------------------------------------------------------------------------------------------------------------------------------------------------------------------------------------------------------------------------------------------------------------------------------------------------------------------------------------------------------------------------------------------------------------------------------------------------------------------------------------------------------------------------------------------------------------------------------------------------------------------------------------------------------------------------------------------------------------------------------------------------------------------------------------------------------------------------------------------------------------------------------------------------------------------------------------------|---|---|---|---|---|---|---|---|---|--|--|---|---|---|---|---|
| <b>SHL</b>                                                                                                                                                                                                                                                                                                                                                                                                                                                                                                                                                                                                                                                                            | <p><b>Shift Left</b></p> <div style="text-align: center; margin: 10px 0;"> <table style="margin: auto;"> <tr> <td>O</td><td>D</td><td>I</td><td>S</td><td>Z</td><td>A</td><td>P</td><td>C</td> </tr> <tr> <td style="border: 1px solid black; width: 20px; height: 15px; text-align: center;">*</td> <td style="border: 1px solid black; width: 20px; height: 15px;"></td> <td style="border: 1px solid black; width: 20px; height: 15px;"></td> <td style="border: 1px solid black; width: 20px; height: 15px; text-align: center;">*</td> <td style="border: 1px solid black; width: 20px; height: 15px; text-align: center;">*</td> <td style="border: 1px solid black; width: 20px; height: 15px; text-align: center;">?</td> <td style="border: 1px solid black; width: 20px; height: 15px; text-align: center;">*</td> <td style="border: 1px solid black; width: 20px; height: 15px; text-align: center;">*</td> </tr> </table> </div> | O | D | I | S | Z | A | P | C | * |  |  | * | * | ? | * | * |
|                                                                                                                                                                                                                                                                                                                                                                                                                                                                                                                                                                                                                                                                                       | O                                                                                                                                                                                                                                                                                                                                                                                                                                                                                                                                                                                                                                                                                                                                                                                                                                                                                                                                             | D | I | S | Z | A | P | C |   |   |  |  |   |   |   |   |   |
| *                                                                                                                                                                                                                                                                                                                                                                                                                                                                                                                                                                                                                                                                                     |                                                                                                                                                                                                                                                                                                                                                                                                                                                                                                                                                                                                                                                                                                                                                                                                                                                                                                                                               |   | * | * | ? | * | * |   |   |   |  |  |   |   |   |   |   |
| <p>Shifts each bit in the destination operand to the left, using the source operand to determine the number of shifts. The highest bit is copied into the Carry flag, and the lowest bit is filled with a zero (identical to SAL). The <i>imm8</i> operand must be a 1 when using the 8086/8088 processor.</p> <p>Instruction formats:</p> <div style="display: flex; justify-content: space-between; margin-top: 10px;"> <span><b>SHL</b> <i>reg, imm8</i></span> <span><b>SHL</b> <i>mem, imm8</i></span> </div> <div style="display: flex; justify-content: space-between; margin-top: 5px;"> <span><b>SHL</b> <i>reg, CL</i></span> <span><b>SHL</b> <i>mem, CL</i></span> </div> |                                                                                                                                                                                                                                                                                                                                                                                                                                                                                                                                                                                                                                                                                                                                                                                                                                                                                                                                               |   |   |   |   |   |   |   |   |   |  |  |   |   |   |   |   |

|                                                                                                                                                                                                                                                                                                                                                                                                                                                                                                                                                                                                                                                                                                                                                                                                                                                                                                                                                                                                                                                                                                                                                               |                                                                                                                                                                                                                                                                                                                                                                                                                                                                                                                                                                                                                                                                                                                                                                                                                                                                                                                                                                      |   |   |   |   |   |   |   |   |   |  |  |   |   |   |   |   |
|---------------------------------------------------------------------------------------------------------------------------------------------------------------------------------------------------------------------------------------------------------------------------------------------------------------------------------------------------------------------------------------------------------------------------------------------------------------------------------------------------------------------------------------------------------------------------------------------------------------------------------------------------------------------------------------------------------------------------------------------------------------------------------------------------------------------------------------------------------------------------------------------------------------------------------------------------------------------------------------------------------------------------------------------------------------------------------------------------------------------------------------------------------------|----------------------------------------------------------------------------------------------------------------------------------------------------------------------------------------------------------------------------------------------------------------------------------------------------------------------------------------------------------------------------------------------------------------------------------------------------------------------------------------------------------------------------------------------------------------------------------------------------------------------------------------------------------------------------------------------------------------------------------------------------------------------------------------------------------------------------------------------------------------------------------------------------------------------------------------------------------------------|---|---|---|---|---|---|---|---|---|--|--|---|---|---|---|---|
| <b>SHLD</b>                                                                                                                                                                                                                                                                                                                                                                                                                                                                                                                                                                                                                                                                                                                                                                                                                                                                                                                                                                                                                                                                                                                                                   | <p><b>Double-Precision Shift Left (x86)</b></p> <div style="text-align: center; margin: 10px 0;"> <table style="margin: auto;"> <tr> <td>O</td><td>D</td><td>I</td><td>S</td><td>Z</td><td>A</td><td>P</td><td>C</td> </tr> <tr> <td style="border: 1px solid black; width: 20px; height: 15px; text-align: center;">*</td> <td style="border: 1px solid black; width: 20px; height: 15px;"></td> <td style="border: 1px solid black; width: 20px; height: 15px;"></td> <td style="border: 1px solid black; width: 20px; height: 15px; text-align: center;">*</td> <td style="border: 1px solid black; width: 20px; height: 15px; text-align: center;">*</td> <td style="border: 1px solid black; width: 20px; height: 15px; text-align: center;">?</td> <td style="border: 1px solid black; width: 20px; height: 15px; text-align: center;">*</td> <td style="border: 1px solid black; width: 20px; height: 15px; text-align: center;">*</td> </tr> </table> </div> | O | D | I | S | Z | A | P | C | * |  |  | * | * | ? | * | * |
|                                                                                                                                                                                                                                                                                                                                                                                                                                                                                                                                                                                                                                                                                                                                                                                                                                                                                                                                                                                                                                                                                                                                                               | O                                                                                                                                                                                                                                                                                                                                                                                                                                                                                                                                                                                                                                                                                                                                                                                                                                                                                                                                                                    | D | I | S | Z | A | P | C |   |   |  |  |   |   |   |   |   |
| *                                                                                                                                                                                                                                                                                                                                                                                                                                                                                                                                                                                                                                                                                                                                                                                                                                                                                                                                                                                                                                                                                                                                                             |                                                                                                                                                                                                                                                                                                                                                                                                                                                                                                                                                                                                                                                                                                                                                                                                                                                                                                                                                                      |   | * | * | ? | * | * |   |   |   |  |  |   |   |   |   |   |
| <p>Shifts the bits of the second operand into the first operand. The third operand indicates the number of bits to be shifted. The positions opened by the shift are filled by the most significant bits of the second operand. The second operand must always be a register, and the third operand may be either an immediate value or the CL register.</p> <p>Instruction formats:</p> <div style="display: flex; justify-content: space-between; margin-top: 10px;"> <span><b>SHLD</b> <i>reg16, reg16, imm8</i></span> <span><b>SHLD</b> <i>mem16, reg16, imm8</i></span> </div> <div style="display: flex; justify-content: space-between; margin-top: 5px;"> <span><b>SHLD</b> <i>reg32, reg32, imm8</i></span> <span><b>SHLD</b> <i>mem32, reg32, imm8</i></span> </div> <div style="display: flex; justify-content: space-between; margin-top: 5px;"> <span><b>SHLD</b> <i>reg16, reg16, CL</i></span> <span><b>SHLD</b> <i>mem16, reg16, CL</i></span> </div> <div style="display: flex; justify-content: space-between; margin-top: 5px;"> <span><b>SHLD</b> <i>reg32, reg32, CL</i></span> <span><b>SHLD</b> <i>mem32, reg32, CL</i></span> </div> |                                                                                                                                                                                                                                                                                                                                                                                                                                                                                                                                                                                                                                                                                                                                                                                                                                                                                                                                                                      |   |   |   |   |   |   |   |   |   |  |  |   |   |   |   |   |

|                                                                                                                                                                                                                                                                                                                                                                                                                                                                                                                                                                                                                                          |                                                                                                                                                                                                                                                                                                                                                                                                                                                                                                                                                                                                                                                                                       |                      |                      |                    |                    |   |   |   |   |   |  |  |   |   |   |   |
|------------------------------------------------------------------------------------------------------------------------------------------------------------------------------------------------------------------------------------------------------------------------------------------------------------------------------------------------------------------------------------------------------------------------------------------------------------------------------------------------------------------------------------------------------------------------------------------------------------------------------------------|---------------------------------------------------------------------------------------------------------------------------------------------------------------------------------------------------------------------------------------------------------------------------------------------------------------------------------------------------------------------------------------------------------------------------------------------------------------------------------------------------------------------------------------------------------------------------------------------------------------------------------------------------------------------------------------|----------------------|----------------------|--------------------|--------------------|---|---|---|---|---|--|--|---|---|---|---|
| <b>SHR</b>                                                                                                                                                                                                                                                                                                                                                                                                                                                                                                                                                                                                                               | <b>Shift Right</b>                                                                                                                                                                                                                                                                                                                                                                                                                                                                                                                                                                                                                                                                    |                      |                      |                    |                    |   |   |   |   |   |  |  |   |   |   |   |
|                                                                                                                                                                                                                                                                                                                                                                                                                                                                                                                                                                                                                                          | <table border="1" style="margin: auto;"> <tr> <td style="padding: 2px 5px;">O</td> <td style="padding: 2px 5px;">D</td> <td style="padding: 2px 5px;">I</td> <td style="padding: 2px 5px;">S</td> <td style="padding: 2px 5px;">Z</td> <td style="padding: 2px 5px;">A</td> <td style="padding: 2px 5px;">P</td> <td style="padding: 2px 5px;">C</td> </tr> <tr> <td style="padding: 2px 5px;">*</td> <td style="padding: 2px 5px;"></td> <td style="padding: 2px 5px;"></td> <td style="padding: 2px 5px;">*</td> <td style="padding: 2px 5px;">*</td> <td style="padding: 2px 5px;">?</td> <td style="padding: 2px 5px;">*</td> <td style="padding: 2px 5px;">*</td> </tr> </table> | O                    | D                    | I                  | S                  | Z | A | P | C | * |  |  | * | * | ? | * |
| O                                                                                                                                                                                                                                                                                                                                                                                                                                                                                                                                                                                                                                        | D                                                                                                                                                                                                                                                                                                                                                                                                                                                                                                                                                                                                                                                                                     | I                    | S                    | Z                  | A                  | P | C |   |   |   |  |  |   |   |   |   |
| *                                                                                                                                                                                                                                                                                                                                                                                                                                                                                                                                                                                                                                        |                                                                                                                                                                                                                                                                                                                                                                                                                                                                                                                                                                                                                                                                                       |                      | *                    | *                  | ?                  | * | * |   |   |   |  |  |   |   |   |   |
| <p>Shifts each bit in the destination operand to the right, using the source operand to determine the number of shifts. The highest bit is filled with a zero, and the lowest bit is copied into the Carry flag. The <i>imm8</i> operand must be a 1 when using the 8086/8088 processor.</p> <p>Instruction formats:</p> <table style="width: 100%; border: none;"> <tr> <td style="padding-left: 40px;"><i>SHR reg, imm8</i></td> <td style="padding-left: 100px;"><i>SHR mem, imm8</i></td> </tr> <tr> <td style="padding-left: 40px;"><i>SHR reg, CL</i></td> <td style="padding-left: 100px;"><i>SHR mem, CL</i></td> </tr> </table> |                                                                                                                                                                                                                                                                                                                                                                                                                                                                                                                                                                                                                                                                                       | <i>SHR reg, imm8</i> | <i>SHR mem, imm8</i> | <i>SHR reg, CL</i> | <i>SHR mem, CL</i> |   |   |   |   |   |  |  |   |   |   |   |
| <i>SHR reg, imm8</i>                                                                                                                                                                                                                                                                                                                                                                                                                                                                                                                                                                                                                     | <i>SHR mem, imm8</i>                                                                                                                                                                                                                                                                                                                                                                                                                                                                                                                                                                                                                                                                  |                      |                      |                    |                    |   |   |   |   |   |  |  |   |   |   |   |
| <i>SHR reg, CL</i>                                                                                                                                                                                                                                                                                                                                                                                                                                                                                                                                                                                                                       | <i>SHR mem, CL</i>                                                                                                                                                                                                                                                                                                                                                                                                                                                                                                                                                                                                                                                                    |                      |                      |                    |                    |   |   |   |   |   |  |  |   |   |   |   |

|                                                                                                                                                                                                                                                                                                                                                                                                                                                                                                                                                                                                                                                                                                                                                                                                                                                                                                                                                                                                                                                       |                                                                                                                                                                                                                                                                                                                                                                                                                                                                                                                                                                                                                                                                                       |                                |                                |                                |                                |                              |                              |                              |                              |   |  |  |   |   |   |   |
|-------------------------------------------------------------------------------------------------------------------------------------------------------------------------------------------------------------------------------------------------------------------------------------------------------------------------------------------------------------------------------------------------------------------------------------------------------------------------------------------------------------------------------------------------------------------------------------------------------------------------------------------------------------------------------------------------------------------------------------------------------------------------------------------------------------------------------------------------------------------------------------------------------------------------------------------------------------------------------------------------------------------------------------------------------|---------------------------------------------------------------------------------------------------------------------------------------------------------------------------------------------------------------------------------------------------------------------------------------------------------------------------------------------------------------------------------------------------------------------------------------------------------------------------------------------------------------------------------------------------------------------------------------------------------------------------------------------------------------------------------------|--------------------------------|--------------------------------|--------------------------------|--------------------------------|------------------------------|------------------------------|------------------------------|------------------------------|---|--|--|---|---|---|---|
| <b>SHRD</b>                                                                                                                                                                                                                                                                                                                                                                                                                                                                                                                                                                                                                                                                                                                                                                                                                                                                                                                                                                                                                                           | <b>Double-Precision Shift Right (x86)</b>                                                                                                                                                                                                                                                                                                                                                                                                                                                                                                                                                                                                                                             |                                |                                |                                |                                |                              |                              |                              |                              |   |  |  |   |   |   |   |
|                                                                                                                                                                                                                                                                                                                                                                                                                                                                                                                                                                                                                                                                                                                                                                                                                                                                                                                                                                                                                                                       | <table border="1" style="margin: auto;"> <tr> <td style="padding: 2px 5px;">O</td> <td style="padding: 2px 5px;">D</td> <td style="padding: 2px 5px;">I</td> <td style="padding: 2px 5px;">S</td> <td style="padding: 2px 5px;">Z</td> <td style="padding: 2px 5px;">A</td> <td style="padding: 2px 5px;">P</td> <td style="padding: 2px 5px;">C</td> </tr> <tr> <td style="padding: 2px 5px;">*</td> <td style="padding: 2px 5px;"></td> <td style="padding: 2px 5px;"></td> <td style="padding: 2px 5px;">*</td> <td style="padding: 2px 5px;">*</td> <td style="padding: 2px 5px;">?</td> <td style="padding: 2px 5px;">*</td> <td style="padding: 2px 5px;">*</td> </tr> </table> | O                              | D                              | I                              | S                              | Z                            | A                            | P                            | C                            | * |  |  | * | * | ? | * |
| O                                                                                                                                                                                                                                                                                                                                                                                                                                                                                                                                                                                                                                                                                                                                                                                                                                                                                                                                                                                                                                                     | D                                                                                                                                                                                                                                                                                                                                                                                                                                                                                                                                                                                                                                                                                     | I                              | S                              | Z                              | A                              | P                            | C                            |                              |                              |   |  |  |   |   |   |   |
| *                                                                                                                                                                                                                                                                                                                                                                                                                                                                                                                                                                                                                                                                                                                                                                                                                                                                                                                                                                                                                                                     |                                                                                                                                                                                                                                                                                                                                                                                                                                                                                                                                                                                                                                                                                       |                                | *                              | *                              | ?                              | *                            | *                            |                              |                              |   |  |  |   |   |   |   |
| <p>Shifts the bits of the second operand into the first operand. The third operand indicates the number of bits to be shifted. The positions opened by the shift are filled by the least significant bits of the second operand. The second operand must always be a register, and the third operand may be either an immediate value or the CL register.</p> <p>Instruction formats:</p> <table style="width: 100%; border: none;"> <tr> <td style="padding-left: 40px;"><i>SHRD reg16, reg16, imm8</i></td> <td style="padding-left: 100px;"><i>SHRD mem16, reg16, imm8</i></td> </tr> <tr> <td style="padding-left: 40px;"><i>SHRD reg32, reg32, imm8</i></td> <td style="padding-left: 100px;"><i>SHRD mem32, reg32, imm8</i></td> </tr> <tr> <td style="padding-left: 40px;"><i>SHRD reg16, reg16, CL</i></td> <td style="padding-left: 100px;"><i>SHRD mem16, reg16, CL</i></td> </tr> <tr> <td style="padding-left: 40px;"><i>SHRD reg32, reg32, CL</i></td> <td style="padding-left: 100px;"><i>SHRD mem32, reg32, CL</i></td> </tr> </table> |                                                                                                                                                                                                                                                                                                                                                                                                                                                                                                                                                                                                                                                                                       | <i>SHRD reg16, reg16, imm8</i> | <i>SHRD mem16, reg16, imm8</i> | <i>SHRD reg32, reg32, imm8</i> | <i>SHRD mem32, reg32, imm8</i> | <i>SHRD reg16, reg16, CL</i> | <i>SHRD mem16, reg16, CL</i> | <i>SHRD reg32, reg32, CL</i> | <i>SHRD mem32, reg32, CL</i> |   |  |  |   |   |   |   |
| <i>SHRD reg16, reg16, imm8</i>                                                                                                                                                                                                                                                                                                                                                                                                                                                                                                                                                                                                                                                                                                                                                                                                                                                                                                                                                                                                                        | <i>SHRD mem16, reg16, imm8</i>                                                                                                                                                                                                                                                                                                                                                                                                                                                                                                                                                                                                                                                        |                                |                                |                                |                                |                              |                              |                              |                              |   |  |  |   |   |   |   |
| <i>SHRD reg32, reg32, imm8</i>                                                                                                                                                                                                                                                                                                                                                                                                                                                                                                                                                                                                                                                                                                                                                                                                                                                                                                                                                                                                                        | <i>SHRD mem32, reg32, imm8</i>                                                                                                                                                                                                                                                                                                                                                                                                                                                                                                                                                                                                                                                        |                                |                                |                                |                                |                              |                              |                              |                              |   |  |  |   |   |   |   |
| <i>SHRD reg16, reg16, CL</i>                                                                                                                                                                                                                                                                                                                                                                                                                                                                                                                                                                                                                                                                                                                                                                                                                                                                                                                                                                                                                          | <i>SHRD mem16, reg16, CL</i>                                                                                                                                                                                                                                                                                                                                                                                                                                                                                                                                                                                                                                                          |                                |                                |                                |                                |                              |                              |                              |                              |   |  |  |   |   |   |   |
| <i>SHRD reg32, reg32, CL</i>                                                                                                                                                                                                                                                                                                                                                                                                                                                                                                                                                                                                                                                                                                                                                                                                                                                                                                                                                                                                                          | <i>SHRD mem32, reg32, CL</i>                                                                                                                                                                                                                                                                                                                                                                                                                                                                                                                                                                                                                                                          |                                |                                |                                |                                |                              |                              |                              |                              |   |  |  |   |   |   |   |

|                                                                                                      |                                                                                                                                                                                                                                                                                                                                                                                                                                                                                                                                                                                                                                                                                  |   |   |   |   |   |   |   |   |  |  |  |  |  |  |  |
|------------------------------------------------------------------------------------------------------|----------------------------------------------------------------------------------------------------------------------------------------------------------------------------------------------------------------------------------------------------------------------------------------------------------------------------------------------------------------------------------------------------------------------------------------------------------------------------------------------------------------------------------------------------------------------------------------------------------------------------------------------------------------------------------|---|---|---|---|---|---|---|---|--|--|--|--|--|--|--|
| <b>STC</b>                                                                                           | <b>Set Carry Flag</b>                                                                                                                                                                                                                                                                                                                                                                                                                                                                                                                                                                                                                                                            |   |   |   |   |   |   |   |   |  |  |  |  |  |  |  |
|                                                                                                      | <table border="1" style="margin: auto;"> <tr> <td style="padding: 2px 5px;">O</td> <td style="padding: 2px 5px;">D</td> <td style="padding: 2px 5px;">I</td> <td style="padding: 2px 5px;">S</td> <td style="padding: 2px 5px;">Z</td> <td style="padding: 2px 5px;">A</td> <td style="padding: 2px 5px;">P</td> <td style="padding: 2px 5px;">C</td> </tr> <tr> <td style="padding: 2px 5px;"></td> <td style="padding: 2px 5px;"></td> <td style="padding: 2px 5px;"></td> <td style="padding: 2px 5px;"></td> <td style="padding: 2px 5px;"></td> <td style="padding: 2px 5px;"></td> <td style="padding: 2px 5px;"></td> <td style="padding: 2px 5px;">1</td> </tr> </table> | O | D | I | S | Z | A | P | C |  |  |  |  |  |  |  |
| O                                                                                                    | D                                                                                                                                                                                                                                                                                                                                                                                                                                                                                                                                                                                                                                                                                | I | S | Z | A | P | C |   |   |  |  |  |  |  |  |  |
|                                                                                                      |                                                                                                                                                                                                                                                                                                                                                                                                                                                                                                                                                                                                                                                                                  |   |   |   |   |   | 1 |   |   |  |  |  |  |  |  |  |
| <p>Sets the Carry flag.</p> <p>Instruction format:</p> <p style="text-align: center;"><b>STC</b></p> |                                                                                                                                                                                                                                                                                                                                                                                                                                                                                                                                                                                                                                                                                  |   |   |   |   |   |   |   |   |  |  |  |  |  |  |  |

|                                                                                                                                                                                                                                                               |                                                                                                                                                                                                                                                                                                                                                                                                                                                                                                                                                                                                                                                                                  |   |   |   |   |   |   |   |   |  |   |  |  |  |  |  |
|---------------------------------------------------------------------------------------------------------------------------------------------------------------------------------------------------------------------------------------------------------------|----------------------------------------------------------------------------------------------------------------------------------------------------------------------------------------------------------------------------------------------------------------------------------------------------------------------------------------------------------------------------------------------------------------------------------------------------------------------------------------------------------------------------------------------------------------------------------------------------------------------------------------------------------------------------------|---|---|---|---|---|---|---|---|--|---|--|--|--|--|--|
| <b>STD</b>                                                                                                                                                                                                                                                    | <b>Set Direction Flag</b>                                                                                                                                                                                                                                                                                                                                                                                                                                                                                                                                                                                                                                                        |   |   |   |   |   |   |   |   |  |   |  |  |  |  |  |
|                                                                                                                                                                                                                                                               | <table border="1" style="margin: auto;"> <tr> <td style="padding: 2px 5px;">O</td> <td style="padding: 2px 5px;">D</td> <td style="padding: 2px 5px;">I</td> <td style="padding: 2px 5px;">S</td> <td style="padding: 2px 5px;">Z</td> <td style="padding: 2px 5px;">A</td> <td style="padding: 2px 5px;">P</td> <td style="padding: 2px 5px;">C</td> </tr> <tr> <td style="padding: 2px 5px;"></td> <td style="padding: 2px 5px;">1</td> <td style="padding: 2px 5px;"></td> <td style="padding: 2px 5px;"></td> <td style="padding: 2px 5px;"></td> <td style="padding: 2px 5px;"></td> <td style="padding: 2px 5px;"></td> <td style="padding: 2px 5px;"></td> </tr> </table> | O | D | I | S | Z | A | P | C |  | 1 |  |  |  |  |  |
| O                                                                                                                                                                                                                                                             | D                                                                                                                                                                                                                                                                                                                                                                                                                                                                                                                                                                                                                                                                                | I | S | Z | A | P | C |   |   |  |   |  |  |  |  |  |
|                                                                                                                                                                                                                                                               | 1                                                                                                                                                                                                                                                                                                                                                                                                                                                                                                                                                                                                                                                                                |   |   |   |   |   |   |   |   |  |   |  |  |  |  |  |
| <p>Sets the Direction flag, causing (E)SI and/or (E)DI to be decremented by string primitive instructions. Thus, string processing will be from high addresses to low addresses.</p> <p>Instruction format:</p> <p style="text-align: center;"><b>STD</b></p> |                                                                                                                                                                                                                                                                                                                                                                                                                                                                                                                                                                                                                                                                                  |   |   |   |   |   |   |   |   |  |   |  |  |  |  |  |

|            |                                                                                                                                                                                                                                                                                                                                                                                                                                                                                                                                                                                                                                                                                                                                                                        |   |   |   |   |   |   |   |   |   |   |   |   |   |   |   |   |
|------------|------------------------------------------------------------------------------------------------------------------------------------------------------------------------------------------------------------------------------------------------------------------------------------------------------------------------------------------------------------------------------------------------------------------------------------------------------------------------------------------------------------------------------------------------------------------------------------------------------------------------------------------------------------------------------------------------------------------------------------------------------------------------|---|---|---|---|---|---|---|---|---|---|---|---|---|---|---|---|
| <b>STI</b> | <p><b>Set Interrupt Flag</b></p> <table style="margin-left: auto; margin-right: auto;"> <tr> <td style="text-align: center;">O</td> <td style="text-align: center;">D</td> <td style="text-align: center;">I</td> <td style="text-align: center;">S</td> <td style="text-align: center;">Z</td> <td style="text-align: center;">A</td> <td style="text-align: center;">P</td> <td style="text-align: center;">C</td> </tr> <tr> <td style="text-align: center;">□</td> <td style="text-align: center;">□</td> <td style="text-align: center;">1</td> <td style="text-align: center;">□</td> <td style="text-align: center;">□</td> <td style="text-align: center;">□</td> <td style="text-align: center;">□</td> <td style="text-align: center;">□</td> </tr> </table> | O | D | I | S | Z | A | P | C | □ | □ | 1 | □ | □ | □ | □ | □ |
|            | O                                                                                                                                                                                                                                                                                                                                                                                                                                                                                                                                                                                                                                                                                                                                                                      | D | I | S | Z | A | P | C |   |   |   |   |   |   |   |   |   |
| □          | □                                                                                                                                                                                                                                                                                                                                                                                                                                                                                                                                                                                                                                                                                                                                                                      | 1 | □ | □ | □ | □ | □ |   |   |   |   |   |   |   |   |   |   |
|            | <p>Sets the Interrupt flag, which enables maskable interrupts. Interrupts are automatically disabled when an interrupt occurs, so an interrupt handler procedure immediately reenables them, using STI.<br/>Instruction format:</p> <p style="text-align: center;">STI</p>                                                                                                                                                                                                                                                                                                                                                                                                                                                                                             |   |   |   |   |   |   |   |   |   |   |   |   |   |   |   |   |

|                                              |                                                                                                                                                                                                                                                                                                                                                                                                                                                                                                                                                                                                                                                                                                                                                                                                                          |       |       |       |   |                 |   |                     |   |   |   |   |   |   |   |   |   |
|----------------------------------------------|--------------------------------------------------------------------------------------------------------------------------------------------------------------------------------------------------------------------------------------------------------------------------------------------------------------------------------------------------------------------------------------------------------------------------------------------------------------------------------------------------------------------------------------------------------------------------------------------------------------------------------------------------------------------------------------------------------------------------------------------------------------------------------------------------------------------------|-------|-------|-------|---|-----------------|---|---------------------|---|---|---|---|---|---|---|---|---|
| <b>STOS,<br/>STOSB,<br/>STOSW,<br/>STOSD</b> | <p><b>Store String Data</b></p> <table style="margin-left: auto; margin-right: auto;"> <tr> <td style="text-align: center;">O</td> <td style="text-align: center;">D</td> <td style="text-align: center;">I</td> <td style="text-align: center;">S</td> <td style="text-align: center;">Z</td> <td style="text-align: center;">A</td> <td style="text-align: center;">P</td> <td style="text-align: center;">C</td> </tr> <tr> <td style="text-align: center;">□</td> <td style="text-align: center;">□</td> <td style="text-align: center;">□</td> <td style="text-align: center;">□</td> <td style="text-align: center;">□</td> <td style="text-align: center;">□</td> <td style="text-align: center;">□</td> <td style="text-align: center;">□</td> </tr> </table>                                                    | O     | D     | I     | S | Z               | A | P                   | C | □ | □ | □ | □ | □ | □ | □ | □ |
|                                              | O                                                                                                                                                                                                                                                                                                                                                                                                                                                                                                                                                                                                                                                                                                                                                                                                                        | D     | I     | S     | Z | A               | P | C                   |   |   |   |   |   |   |   |   |   |
| □                                            | □                                                                                                                                                                                                                                                                                                                                                                                                                                                                                                                                                                                                                                                                                                                                                                                                                        | □     | □     | □     | □ | □               | □ |                     |   |   |   |   |   |   |   |   |   |
|                                              | <p>Stores the accumulator in the memory location addressed by ES:(E)DI. If STOS is used, a destination operand must be specified. STOSB copies AL to memory, STOSW copies AX to memory, and STOSD for the x86 processor copies EAX to memory. (E)DI is increased or decreased according to the operand size and the status of the direction flag. If DF = 1, (E)DI is decreased; if DF = 0, (E)DI is increased.<br/>Instruction formats:</p> <table style="width: 100%; border: none;"> <tr> <td style="text-align: center;">STOSB</td> <td style="text-align: center;">STOSW</td> </tr> <tr> <td style="text-align: center;">STOSD</td> <td></td> </tr> <tr> <td style="text-align: center;">STOS <i>mem</i></td> <td></td> </tr> <tr> <td style="text-align: center;">STOS ES:<i>mem</i></td> <td></td> </tr> </table> | STOSB | STOSW | STOSD |   | STOS <i>mem</i> |   | STOS ES: <i>mem</i> |   |   |   |   |   |   |   |   |   |
| STOSB                                        | STOSW                                                                                                                                                                                                                                                                                                                                                                                                                                                                                                                                                                                                                                                                                                                                                                                                                    |       |       |       |   |                 |   |                     |   |   |   |   |   |   |   |   |   |
| STOSD                                        |                                                                                                                                                                                                                                                                                                                                                                                                                                                                                                                                                                                                                                                                                                                                                                                                                          |       |       |       |   |                 |   |                     |   |   |   |   |   |   |   |   |   |
| STOS <i>mem</i>                              |                                                                                                                                                                                                                                                                                                                                                                                                                                                                                                                                                                                                                                                                                                                                                                                                                          |       |       |       |   |                 |   |                     |   |   |   |   |   |   |   |   |   |
| STOS ES: <i>mem</i>                          |                                                                                                                                                                                                                                                                                                                                                                                                                                                                                                                                                                                                                                                                                                                                                                                                                          |       |       |       |   |                 |   |                     |   |   |   |   |   |   |   |   |   |

|                     |                                                                                                                                                                                                                                                                                                                                                                                                                                                                                                                                                                                                                                                                                                                                                              |                     |                     |                     |                     |                     |                       |   |   |   |   |   |   |   |   |   |   |
|---------------------|--------------------------------------------------------------------------------------------------------------------------------------------------------------------------------------------------------------------------------------------------------------------------------------------------------------------------------------------------------------------------------------------------------------------------------------------------------------------------------------------------------------------------------------------------------------------------------------------------------------------------------------------------------------------------------------------------------------------------------------------------------------|---------------------|---------------------|---------------------|---------------------|---------------------|-----------------------|---|---|---|---|---|---|---|---|---|---|
| <b>SUB</b>          | <p><b>Subtract</b></p> <table style="margin-left: auto; margin-right: auto;"> <tr> <td style="text-align: center;">O</td> <td style="text-align: center;">D</td> <td style="text-align: center;">I</td> <td style="text-align: center;">S</td> <td style="text-align: center;">Z</td> <td style="text-align: center;">A</td> <td style="text-align: center;">P</td> <td style="text-align: center;">C</td> </tr> <tr> <td style="text-align: center;">*</td> <td style="text-align: center;">□</td> <td style="text-align: center;">□</td> <td style="text-align: center;">*</td> <td style="text-align: center;">*</td> <td style="text-align: center;">*</td> <td style="text-align: center;">*</td> <td style="text-align: center;">*</td> </tr> </table> | O                   | D                   | I                   | S                   | Z                   | A                     | P | C | * | □ | □ | * | * | * | * | * |
|                     | O                                                                                                                                                                                                                                                                                                                                                                                                                                                                                                                                                                                                                                                                                                                                                            | D                   | I                   | S                   | Z                   | A                   | P                     | C |   |   |   |   |   |   |   |   |   |
| *                   | □                                                                                                                                                                                                                                                                                                                                                                                                                                                                                                                                                                                                                                                                                                                                                            | □                   | *                   | *                   | *                   | *                   | *                     |   |   |   |   |   |   |   |   |   |   |
|                     | <p>Subtracts the source operand from the destination operand.<br/>Instruction formats:</p> <table style="width: 100%; border: none;"> <tr> <td style="text-align: center;">SUB <i>reg, reg</i></td> <td style="text-align: center;">SUB <i>reg, imm</i></td> </tr> <tr> <td style="text-align: center;">SUB <i>mem, reg</i></td> <td style="text-align: center;">SUB <i>mem, imm</i></td> </tr> <tr> <td style="text-align: center;">SUB <i>reg, mem</i></td> <td style="text-align: center;">SUB <i>accum, imm</i></td> </tr> </table>                                                                                                                                                                                                                      | SUB <i>reg, reg</i> | SUB <i>reg, imm</i> | SUB <i>mem, reg</i> | SUB <i>mem, imm</i> | SUB <i>reg, mem</i> | SUB <i>accum, imm</i> |   |   |   |   |   |   |   |   |   |   |
| SUB <i>reg, reg</i> | SUB <i>reg, imm</i>                                                                                                                                                                                                                                                                                                                                                                                                                                                                                                                                                                                                                                                                                                                                          |                     |                     |                     |                     |                     |                       |   |   |   |   |   |   |   |   |   |   |
| SUB <i>mem, reg</i> | SUB <i>mem, imm</i>                                                                                                                                                                                                                                                                                                                                                                                                                                                                                                                                                                                                                                                                                                                                          |                     |                     |                     |                     |                     |                       |   |   |   |   |   |   |   |   |   |   |
| SUB <i>reg, mem</i> | SUB <i>accum, imm</i>                                                                                                                                                                                                                                                                                                                                                                                                                                                                                                                                                                                                                                                                                                                                        |                     |                     |                     |                     |                     |                       |   |   |   |   |   |   |   |   |   |   |

|                      |                                                                                                                                                                                                                                                                                                                                                                                                                                                                                                                                                                                                                                                                                                                                                          |                      |                      |                      |                      |                      |                        |   |   |   |   |   |   |   |   |   |   |
|----------------------|----------------------------------------------------------------------------------------------------------------------------------------------------------------------------------------------------------------------------------------------------------------------------------------------------------------------------------------------------------------------------------------------------------------------------------------------------------------------------------------------------------------------------------------------------------------------------------------------------------------------------------------------------------------------------------------------------------------------------------------------------------|----------------------|----------------------|----------------------|----------------------|----------------------|------------------------|---|---|---|---|---|---|---|---|---|---|
| <b>TEST</b>          | <p><b>Test</b></p> <table style="margin-left: auto; margin-right: auto;"> <tr> <td style="text-align: center;">O</td> <td style="text-align: center;">D</td> <td style="text-align: center;">I</td> <td style="text-align: center;">S</td> <td style="text-align: center;">Z</td> <td style="text-align: center;">A</td> <td style="text-align: center;">P</td> <td style="text-align: center;">C</td> </tr> <tr> <td style="text-align: center;">0</td> <td style="text-align: center;">□</td> <td style="text-align: center;">□</td> <td style="text-align: center;">*</td> <td style="text-align: center;">*</td> <td style="text-align: center;">?</td> <td style="text-align: center;">*</td> <td style="text-align: center;">0</td> </tr> </table> | O                    | D                    | I                    | S                    | Z                    | A                      | P | C | 0 | □ | □ | * | * | ? | * | 0 |
|                      | O                                                                                                                                                                                                                                                                                                                                                                                                                                                                                                                                                                                                                                                                                                                                                        | D                    | I                    | S                    | Z                    | A                    | P                      | C |   |   |   |   |   |   |   |   |   |
| 0                    | □                                                                                                                                                                                                                                                                                                                                                                                                                                                                                                                                                                                                                                                                                                                                                        | □                    | *                    | *                    | ?                    | *                    | 0                      |   |   |   |   |   |   |   |   |   |   |
|                      | <p>Tests individual bits in the destination operand against those in the source operand. Performs a logical AND operation that affects the flags but not the destination operand.<br/>Instruction formats:</p> <table style="width: 100%; border: none;"> <tr> <td style="text-align: center;">TEST <i>reg, reg</i></td> <td style="text-align: center;">TEST <i>reg, imm</i></td> </tr> <tr> <td style="text-align: center;">TEST <i>mem, reg</i></td> <td style="text-align: center;">TEST <i>mem, imm</i></td> </tr> <tr> <td style="text-align: center;">TEST <i>reg, mem</i></td> <td style="text-align: center;">TEST <i>accum, imm</i></td> </tr> </table>                                                                                        | TEST <i>reg, reg</i> | TEST <i>reg, imm</i> | TEST <i>mem, reg</i> | TEST <i>mem, imm</i> | TEST <i>reg, mem</i> | TEST <i>accum, imm</i> |   |   |   |   |   |   |   |   |   |   |
| TEST <i>reg, reg</i> | TEST <i>reg, imm</i>                                                                                                                                                                                                                                                                                                                                                                                                                                                                                                                                                                                                                                                                                                                                     |                      |                      |                      |                      |                      |                        |   |   |   |   |   |   |   |   |   |   |
| TEST <i>mem, reg</i> | TEST <i>mem, imm</i>                                                                                                                                                                                                                                                                                                                                                                                                                                                                                                                                                                                                                                                                                                                                     |                      |                      |                      |                      |                      |                        |   |   |   |   |   |   |   |   |   |   |
| TEST <i>reg, mem</i> | TEST <i>accum, imm</i>                                                                                                                                                                                                                                                                                                                                                                                                                                                                                                                                                                                                                                                                                                                                   |                      |                      |                      |                      |                      |                        |   |   |   |   |   |   |   |   |   |   |

|                                                                                                                                                          |                                                                                                                                                                                                                                                                                                                                                                                                                                                                                                                                                                                                                                                                                                                                                                                                                                                                                                                                                                                                           |   |   |   |   |   |   |   |   |  |  |  |  |  |  |  |  |
|----------------------------------------------------------------------------------------------------------------------------------------------------------|-----------------------------------------------------------------------------------------------------------------------------------------------------------------------------------------------------------------------------------------------------------------------------------------------------------------------------------------------------------------------------------------------------------------------------------------------------------------------------------------------------------------------------------------------------------------------------------------------------------------------------------------------------------------------------------------------------------------------------------------------------------------------------------------------------------------------------------------------------------------------------------------------------------------------------------------------------------------------------------------------------------|---|---|---|---|---|---|---|---|--|--|--|--|--|--|--|--|
| <b>WAIT</b>                                                                                                                                              | <b>Wait for Coprocessor</b><br><br><div style="text-align: center;"> <table style="margin: auto;"> <tr> <td style="padding: 0 5px;">O</td><td style="padding: 0 5px;">D</td><td style="padding: 0 5px;">I</td><td style="padding: 0 5px;">S</td><td style="padding: 0 5px;">Z</td><td style="padding: 0 5px;">A</td><td style="padding: 0 5px;">P</td><td style="padding: 0 5px;">C</td> </tr> <tr> <td style="border: 1px solid black; width: 20px; height: 15px;"></td> <td style="border: 1px solid black; width: 20px; height: 15px;"></td> <td style="border: 1px solid black; width: 20px; height: 15px;"></td> <td style="border: 1px solid black; width: 20px; height: 15px;"></td> <td style="border: 1px solid black; width: 20px; height: 15px;"></td> <td style="border: 1px solid black; width: 20px; height: 15px;"></td> <td style="border: 1px solid black; width: 20px; height: 15px;"></td> <td style="border: 1px solid black; width: 20px; height: 15px;"></td> </tr> </table> </div> | O | D | I | S | Z | A | P | C |  |  |  |  |  |  |  |  |
|                                                                                                                                                          | O                                                                                                                                                                                                                                                                                                                                                                                                                                                                                                                                                                                                                                                                                                                                                                                                                                                                                                                                                                                                         | D | I | S | Z | A | P | C |   |  |  |  |  |  |  |  |  |
|                                                                                                                                                          |                                                                                                                                                                                                                                                                                                                                                                                                                                                                                                                                                                                                                                                                                                                                                                                                                                                                                                                                                                                                           |   |   |   |   |   |   |   |   |  |  |  |  |  |  |  |  |
| Suspends CPU execution until the coprocessor finishes the current instruction.<br>Instruction format:<br><br><div style="text-align: center;">WAIT</div> |                                                                                                                                                                                                                                                                                                                                                                                                                                                                                                                                                                                                                                                                                                                                                                                                                                                                                                                                                                                                           |   |   |   |   |   |   |   |   |  |  |  |  |  |  |  |  |

|                                                                                                                                                                                                                                                                                                             |                                                                                                                                                                                                                                                                                                                                                                                                                                                                                                                                                                                                                                                                                                                                                                                                                                                                                                                                                                                                                                                                                                                                                |   |   |   |   |   |   |   |   |   |  |  |   |   |   |   |   |
|-------------------------------------------------------------------------------------------------------------------------------------------------------------------------------------------------------------------------------------------------------------------------------------------------------------|------------------------------------------------------------------------------------------------------------------------------------------------------------------------------------------------------------------------------------------------------------------------------------------------------------------------------------------------------------------------------------------------------------------------------------------------------------------------------------------------------------------------------------------------------------------------------------------------------------------------------------------------------------------------------------------------------------------------------------------------------------------------------------------------------------------------------------------------------------------------------------------------------------------------------------------------------------------------------------------------------------------------------------------------------------------------------------------------------------------------------------------------|---|---|---|---|---|---|---|---|---|--|--|---|---|---|---|---|
| <b>XADD</b>                                                                                                                                                                                                                                                                                                 | <b>Exchange and Add (Intel486)</b><br><br><div style="text-align: center;"> <table style="margin: auto;"> <tr> <td style="padding: 0 5px;">O</td><td style="padding: 0 5px;">D</td><td style="padding: 0 5px;">I</td><td style="padding: 0 5px;">S</td><td style="padding: 0 5px;">Z</td><td style="padding: 0 5px;">A</td><td style="padding: 0 5px;">P</td><td style="padding: 0 5px;">C</td> </tr> <tr> <td style="border: 1px solid black; width: 20px; height: 15px; text-align: center;">*</td> <td style="border: 1px solid black; width: 20px; height: 15px;"></td> <td style="border: 1px solid black; width: 20px; height: 15px;"></td> <td style="border: 1px solid black; width: 20px; height: 15px; text-align: center;">*</td> <td style="border: 1px solid black; width: 20px; height: 15px; text-align: center;">*</td> <td style="border: 1px solid black; width: 20px; height: 15px; text-align: center;">*</td> <td style="border: 1px solid black; width: 20px; height: 15px; text-align: center;">*</td> <td style="border: 1px solid black; width: 20px; height: 15px; text-align: center;">*</td> </tr> </table> </div> | O | D | I | S | Z | A | P | C | * |  |  | * | * | * | * | * |
|                                                                                                                                                                                                                                                                                                             | O                                                                                                                                                                                                                                                                                                                                                                                                                                                                                                                                                                                                                                                                                                                                                                                                                                                                                                                                                                                                                                                                                                                                              | D | I | S | Z | A | P | C |   |   |  |  |   |   |   |   |   |
| *                                                                                                                                                                                                                                                                                                           |                                                                                                                                                                                                                                                                                                                                                                                                                                                                                                                                                                                                                                                                                                                                                                                                                                                                                                                                                                                                                                                                                                                                                |   | * | * | * | * | * |   |   |   |  |  |   |   |   |   |   |
| Adds the source operand to the destination operand. At the same time, the original destination value is moved to the source operand.<br>Instruction formats:<br><br><div style="display: flex; justify-content: space-between;"> <span>XADD <i>reg, reg</i></span> <span>XADD <i>mem, reg</i></span> </div> |                                                                                                                                                                                                                                                                                                                                                                                                                                                                                                                                                                                                                                                                                                                                                                                                                                                                                                                                                                                                                                                                                                                                                |   |   |   |   |   |   |   |   |   |  |  |   |   |   |   |   |

|                                                                                                                                                                                                                                                                                                                                                           |                                                                                                                                                                                                                                                                                                                                                                                                                                                                                                                                                                                                                                                                                                                                                                                                                                                                                                                                                                                               |   |   |   |   |   |   |   |   |  |  |  |  |  |  |  |  |
|-----------------------------------------------------------------------------------------------------------------------------------------------------------------------------------------------------------------------------------------------------------------------------------------------------------------------------------------------------------|-----------------------------------------------------------------------------------------------------------------------------------------------------------------------------------------------------------------------------------------------------------------------------------------------------------------------------------------------------------------------------------------------------------------------------------------------------------------------------------------------------------------------------------------------------------------------------------------------------------------------------------------------------------------------------------------------------------------------------------------------------------------------------------------------------------------------------------------------------------------------------------------------------------------------------------------------------------------------------------------------|---|---|---|---|---|---|---|---|--|--|--|--|--|--|--|--|
| <b>XCHG</b>                                                                                                                                                                                                                                                                                                                                               | <b>Exchange</b><br><br><div style="text-align: center;"> <table style="margin: auto;"> <tr> <td style="padding: 0 5px;">O</td><td style="padding: 0 5px;">D</td><td style="padding: 0 5px;">I</td><td style="padding: 0 5px;">S</td><td style="padding: 0 5px;">Z</td><td style="padding: 0 5px;">A</td><td style="padding: 0 5px;">P</td><td style="padding: 0 5px;">C</td> </tr> <tr> <td style="border: 1px solid black; width: 20px; height: 15px;"></td> <td style="border: 1px solid black; width: 20px; height: 15px;"></td> <td style="border: 1px solid black; width: 20px; height: 15px;"></td> <td style="border: 1px solid black; width: 20px; height: 15px;"></td> <td style="border: 1px solid black; width: 20px; height: 15px;"></td> <td style="border: 1px solid black; width: 20px; height: 15px;"></td> <td style="border: 1px solid black; width: 20px; height: 15px;"></td> <td style="border: 1px solid black; width: 20px; height: 15px;"></td> </tr> </table> </div> | O | D | I | S | Z | A | P | C |  |  |  |  |  |  |  |  |
|                                                                                                                                                                                                                                                                                                                                                           | O                                                                                                                                                                                                                                                                                                                                                                                                                                                                                                                                                                                                                                                                                                                                                                                                                                                                                                                                                                                             | D | I | S | Z | A | P | C |   |  |  |  |  |  |  |  |  |
|                                                                                                                                                                                                                                                                                                                                                           |                                                                                                                                                                                                                                                                                                                                                                                                                                                                                                                                                                                                                                                                                                                                                                                                                                                                                                                                                                                               |   |   |   |   |   |   |   |   |  |  |  |  |  |  |  |  |
| Exchanges the contents of the source and destination operands.<br>Instruction formats:<br><br><div style="display: flex; justify-content: space-between;"> <span>XCH <i>reg, reg</i></span> <span>XCH <i>mem, reg</i></span> </div> <div style="display: flex; justify-content: space-between; margin-top: 5px;"> <span>XCH <i>reg, mem</i></span> </div> |                                                                                                                                                                                                                                                                                                                                                                                                                                                                                                                                                                                                                                                                                                                                                                                                                                                                                                                                                                                               |   |   |   |   |   |   |   |   |  |  |  |  |  |  |  |  |

|                                                                                                                                                                                                                                                                                                                                                                                                                                                                                                                        |                                                                                                                                                                                                                                                                                                                                                                                                                                                                                                                                                                                                                                                                                                                                                                                                                                                                                                                                                                                                     |   |   |   |   |   |   |   |   |  |  |  |  |  |  |  |  |
|------------------------------------------------------------------------------------------------------------------------------------------------------------------------------------------------------------------------------------------------------------------------------------------------------------------------------------------------------------------------------------------------------------------------------------------------------------------------------------------------------------------------|-----------------------------------------------------------------------------------------------------------------------------------------------------------------------------------------------------------------------------------------------------------------------------------------------------------------------------------------------------------------------------------------------------------------------------------------------------------------------------------------------------------------------------------------------------------------------------------------------------------------------------------------------------------------------------------------------------------------------------------------------------------------------------------------------------------------------------------------------------------------------------------------------------------------------------------------------------------------------------------------------------|---|---|---|---|---|---|---|---|--|--|--|--|--|--|--|--|
| <b>XLAT,<br/>XLATB</b>                                                                                                                                                                                                                                                                                                                                                                                                                                                                                                 | <b>Translate Byte</b><br><br><div style="text-align: center;"> <table style="margin: auto;"> <tr> <td style="padding: 0 5px;">O</td><td style="padding: 0 5px;">D</td><td style="padding: 0 5px;">I</td><td style="padding: 0 5px;">S</td><td style="padding: 0 5px;">Z</td><td style="padding: 0 5px;">A</td><td style="padding: 0 5px;">P</td><td style="padding: 0 5px;">C</td> </tr> <tr> <td style="border: 1px solid black; width: 20px; height: 15px;"></td> <td style="border: 1px solid black; width: 20px; height: 15px;"></td> <td style="border: 1px solid black; width: 20px; height: 15px;"></td> <td style="border: 1px solid black; width: 20px; height: 15px;"></td> <td style="border: 1px solid black; width: 20px; height: 15px;"></td> <td style="border: 1px solid black; width: 20px; height: 15px;"></td> <td style="border: 1px solid black; width: 20px; height: 15px;"></td> <td style="border: 1px solid black; width: 20px; height: 15px;"></td> </tr> </table> </div> | O | D | I | S | Z | A | P | C |  |  |  |  |  |  |  |  |
|                                                                                                                                                                                                                                                                                                                                                                                                                                                                                                                        | O                                                                                                                                                                                                                                                                                                                                                                                                                                                                                                                                                                                                                                                                                                                                                                                                                                                                                                                                                                                                   | D | I | S | Z | A | P | C |   |  |  |  |  |  |  |  |  |
|                                                                                                                                                                                                                                                                                                                                                                                                                                                                                                                        |                                                                                                                                                                                                                                                                                                                                                                                                                                                                                                                                                                                                                                                                                                                                                                                                                                                                                                                                                                                                     |   |   |   |   |   |   |   |   |  |  |  |  |  |  |  |  |
| Uses the value in AL to index into a table pointed to by DS:BX. The byte pointed to by the index is moved to AL. An operand may be specified in order to provide a segment override. XLATB may be substituted for XLAT.<br>Instruction formats:<br><br><div style="display: flex; justify-content: space-between;"> <span>XLAT</span> <span>XLAT <i>segreg: mem</i></span> </div> <div style="display: flex; justify-content: space-between; margin-top: 5px;"> <span>XLAT <i>mem</i></span> <span>XLATB</span> </div> |                                                                                                                                                                                                                                                                                                                                                                                                                                                                                                                                                                                                                                                                                                                                                                                                                                                                                                                                                                                                     |   |   |   |   |   |   |   |   |  |  |  |  |  |  |  |  |

|                                                                                                                                                                                                                                                                                                                                                                                                                                                                                                                                                                                                                                                                        |                                                                                                                                                                                                                                                                                                                                                                                                                                                                                                                                                                                                                                                                                                                                                                                                                                                                                                                                                        |                     |                     |                     |                     |                     |                       |   |   |   |  |  |   |   |   |   |
|------------------------------------------------------------------------------------------------------------------------------------------------------------------------------------------------------------------------------------------------------------------------------------------------------------------------------------------------------------------------------------------------------------------------------------------------------------------------------------------------------------------------------------------------------------------------------------------------------------------------------------------------------------------------|--------------------------------------------------------------------------------------------------------------------------------------------------------------------------------------------------------------------------------------------------------------------------------------------------------------------------------------------------------------------------------------------------------------------------------------------------------------------------------------------------------------------------------------------------------------------------------------------------------------------------------------------------------------------------------------------------------------------------------------------------------------------------------------------------------------------------------------------------------------------------------------------------------------------------------------------------------|---------------------|---------------------|---------------------|---------------------|---------------------|-----------------------|---|---|---|--|--|---|---|---|---|
| <b>XOR</b>                                                                                                                                                                                                                                                                                                                                                                                                                                                                                                                                                                                                                                                             | <b>Exclusive OR</b>                                                                                                                                                                                                                                                                                                                                                                                                                                                                                                                                                                                                                                                                                                                                                                                                                                                                                                                                    |                     |                     |                     |                     |                     |                       |   |   |   |  |  |   |   |   |   |
|                                                                                                                                                                                                                                                                                                                                                                                                                                                                                                                                                                                                                                                                        | <table style="margin-left: auto; margin-right: auto; border-collapse: collapse;"> <tr> <td style="padding: 2px 10px;">O</td> <td style="padding: 2px 10px;">D</td> <td style="padding: 2px 10px;">I</td> <td style="padding: 2px 10px;">S</td> <td style="padding: 2px 10px;">Z</td> <td style="padding: 2px 10px;">A</td> <td style="padding: 2px 10px;">P</td> <td style="padding: 2px 10px;">C</td> </tr> <tr> <td style="padding: 2px 10px; border: 1px solid black;">0</td> <td style="padding: 2px 10px; border: 1px solid black;"></td> <td style="padding: 2px 10px; border: 1px solid black;"></td> <td style="padding: 2px 10px; border: 1px solid black;">*</td> <td style="padding: 2px 10px; border: 1px solid black;">*</td> <td style="padding: 2px 10px; border: 1px solid black;">?</td> <td style="padding: 2px 10px; border: 1px solid black;">*</td> <td style="padding: 2px 10px; border: 1px solid black;">0</td> </tr> </table> | O                   | D                   | I                   | S                   | Z                   | A                     | P | C | 0 |  |  | * | * | ? | * |
| O                                                                                                                                                                                                                                                                                                                                                                                                                                                                                                                                                                                                                                                                      | D                                                                                                                                                                                                                                                                                                                                                                                                                                                                                                                                                                                                                                                                                                                                                                                                                                                                                                                                                      | I                   | S                   | Z                   | A                   | P                   | C                     |   |   |   |  |  |   |   |   |   |
| 0                                                                                                                                                                                                                                                                                                                                                                                                                                                                                                                                                                                                                                                                      |                                                                                                                                                                                                                                                                                                                                                                                                                                                                                                                                                                                                                                                                                                                                                                                                                                                                                                                                                        |                     | *                   | *                   | ?                   | *                   | 0                     |   |   |   |  |  |   |   |   |   |
| <p>Each bit in the source operand is exclusive ORed with its corresponding bit in the destination. The destination bit is a 1 only when the original source and destination bits are different.</p> <p>Instruction formats:</p> <table style="width: 100%; border: none;"> <tr> <td style="padding: 2px 20px;">XOR <i>reg, reg</i></td> <td style="padding: 2px 20px;">XOR <i>reg, imm</i></td> </tr> <tr> <td style="padding: 2px 20px;">XOR <i>mem, reg</i></td> <td style="padding: 2px 20px;">XOR <i>mem, imm</i></td> </tr> <tr> <td style="padding: 2px 20px;">XOR <i>reg, mem</i></td> <td style="padding: 2px 20px;">XOR <i>accum, imm</i></td> </tr> </table> |                                                                                                                                                                                                                                                                                                                                                                                                                                                                                                                                                                                                                                                                                                                                                                                                                                                                                                                                                        | XOR <i>reg, reg</i> | XOR <i>reg, imm</i> | XOR <i>mem, reg</i> | XOR <i>mem, imm</i> | XOR <i>reg, mem</i> | XOR <i>accum, imm</i> |   |   |   |  |  |   |   |   |   |
| XOR <i>reg, reg</i>                                                                                                                                                                                                                                                                                                                                                                                                                                                                                                                                                                                                                                                    | XOR <i>reg, imm</i>                                                                                                                                                                                                                                                                                                                                                                                                                                                                                                                                                                                                                                                                                                                                                                                                                                                                                                                                    |                     |                     |                     |                     |                     |                       |   |   |   |  |  |   |   |   |   |
| XOR <i>mem, reg</i>                                                                                                                                                                                                                                                                                                                                                                                                                                                                                                                                                                                                                                                    | XOR <i>mem, imm</i>                                                                                                                                                                                                                                                                                                                                                                                                                                                                                                                                                                                                                                                                                                                                                                                                                                                                                                                                    |                     |                     |                     |                     |                     |                       |   |   |   |  |  |   |   |   |   |
| XOR <i>reg, mem</i>                                                                                                                                                                                                                                                                                                                                                                                                                                                                                                                                                                                                                                                    | XOR <i>accum, imm</i>                                                                                                                                                                                                                                                                                                                                                                                                                                                                                                                                                                                                                                                                                                                                                                                                                                                                                                                                  |                     |                     |                     |                     |                     |                       |   |   |   |  |  |   |   |   |   |

### B.3 Floating-Point Instructions

Table B-3 contains a list of all x86 floating-point instructions, with brief descriptions and operand formats. Instructions are usually grouped by function rather than strict alphabetical order. For example, the FIADD instruction immediately follows FADD and FADDP because it performs the same operation with integer conversion.

For complete information about floating-point instructions, consult the Intel Architecture Manuals. The word *stack* in this table refers to the FPU register stack. (Table B-1 lists many of the symbols used when describing the formats and operands of floating-point instructions.)

Table B-3 Floating-Point Instructions.

| Instruction         | Description                                                                                                                                                                                                                                                                                                                                                                                                                                                                                                                                                                                                                                                                                                                                                                                                             |                     |                                        |                     |                            |                   |                           |                  |                    |                  |                    |
|---------------------|-------------------------------------------------------------------------------------------------------------------------------------------------------------------------------------------------------------------------------------------------------------------------------------------------------------------------------------------------------------------------------------------------------------------------------------------------------------------------------------------------------------------------------------------------------------------------------------------------------------------------------------------------------------------------------------------------------------------------------------------------------------------------------------------------------------------------|---------------------|----------------------------------------|---------------------|----------------------------|-------------------|---------------------------|------------------|--------------------|------------------|--------------------|
| F2XM1               | <b>Compute <math>2^x - 1</math>.</b> No operands.                                                                                                                                                                                                                                                                                                                                                                                                                                                                                                                                                                                                                                                                                                                                                                       |                     |                                        |                     |                            |                   |                           |                  |                    |                  |                    |
| FABS                | <b>Absolute value.</b> Clears sign bit of ST(0). No operands.                                                                                                                                                                                                                                                                                                                                                                                                                                                                                                                                                                                                                                                                                                                                                           |                     |                                        |                     |                            |                   |                           |                  |                    |                  |                    |
| FADD                | <b>Add floating-point.</b> Adds destination and source operands, stores sum in destination operand. Formats: <table style="width: 100%; border: none; margin-top: 5px;"> <tr> <td style="padding: 2px 20px;">FADD</td> <td style="padding: 2px 20px;">Add ST(0) to ST(1), and pop stack</td> </tr> <tr> <td style="padding: 2px 20px;">FADD <i>m32fp</i></td> <td style="padding: 2px 20px;">Add <i>m32fp</i> to ST(0)</td> </tr> <tr> <td style="padding: 2px 20px;">FADD <i>m64fp</i></td> <td style="padding: 2px 20px;">Add <i>m64fp</i> to ST(0)</td> </tr> <tr> <td style="padding: 2px 20px;">FADD ST(0),ST(i)</td> <td style="padding: 2px 20px;">Add ST(i) to ST(0)</td> </tr> <tr> <td style="padding: 2px 20px;">FADD ST(i),ST(0)</td> <td style="padding: 2px 20px;">Add ST(0) to ST(i)</td> </tr> </table> | FADD                | Add ST(0) to ST(1), and pop stack      | FADD <i>m32fp</i>   | Add <i>m32fp</i> to ST(0)  | FADD <i>m64fp</i> | Add <i>m64fp</i> to ST(0) | FADD ST(0),ST(i) | Add ST(i) to ST(0) | FADD ST(i),ST(0) | Add ST(0) to ST(i) |
| FADD                | Add ST(0) to ST(1), and pop stack                                                                                                                                                                                                                                                                                                                                                                                                                                                                                                                                                                                                                                                                                                                                                                                       |                     |                                        |                     |                            |                   |                           |                  |                    |                  |                    |
| FADD <i>m32fp</i>   | Add <i>m32fp</i> to ST(0)                                                                                                                                                                                                                                                                                                                                                                                                                                                                                                                                                                                                                                                                                                                                                                                               |                     |                                        |                     |                            |                   |                           |                  |                    |                  |                    |
| FADD <i>m64fp</i>   | Add <i>m64fp</i> to ST(0)                                                                                                                                                                                                                                                                                                                                                                                                                                                                                                                                                                                                                                                                                                                                                                                               |                     |                                        |                     |                            |                   |                           |                  |                    |                  |                    |
| FADD ST(0),ST(i)    | Add ST(i) to ST(0)                                                                                                                                                                                                                                                                                                                                                                                                                                                                                                                                                                                                                                                                                                                                                                                                      |                     |                                        |                     |                            |                   |                           |                  |                    |                  |                    |
| FADD ST(i),ST(0)    | Add ST(0) to ST(i)                                                                                                                                                                                                                                                                                                                                                                                                                                                                                                                                                                                                                                                                                                                                                                                                      |                     |                                        |                     |                            |                   |                           |                  |                    |                  |                    |
| FADDP               | <b>Add floating-point and pop.</b> Performs the same operation as FADD, then pops the stack. Format: <table style="width: 100%; border: none; margin-top: 5px;"> <tr> <td style="padding: 2px 20px;">FADDP ST(i),ST(0)</td> <td style="padding: 2px 20px;">Add ST(0) to ST(i)</td> </tr> </table>                                                                                                                                                                                                                                                                                                                                                                                                                                                                                                                       | FADDP ST(i),ST(0)   | Add ST(0) to ST(i)                     |                     |                            |                   |                           |                  |                    |                  |                    |
| FADDP ST(i),ST(0)   | Add ST(0) to ST(i)                                                                                                                                                                                                                                                                                                                                                                                                                                                                                                                                                                                                                                                                                                                                                                                                      |                     |                                        |                     |                            |                   |                           |                  |                    |                  |                    |
| FIADD               | <b>Convert integer to floating-point and add.</b> Adds destination and source operands, stores sum in destination operand. Formats: <table style="width: 100%; border: none; margin-top: 5px;"> <tr> <td style="padding: 2px 20px;">FIADD <i>m32int</i></td> <td style="padding: 2px 20px;">Add <i>m32int</i> to ST(0)</td> </tr> <tr> <td style="padding: 2px 20px;">FIADD <i>m16int</i></td> <td style="padding: 2px 20px;">Add <i>m16int</i> to ST(0)</td> </tr> </table>                                                                                                                                                                                                                                                                                                                                            | FIADD <i>m32int</i> | Add <i>m32int</i> to ST(0)             | FIADD <i>m16int</i> | Add <i>m16int</i> to ST(0) |                   |                           |                  |                    |                  |                    |
| FIADD <i>m32int</i> | Add <i>m32int</i> to ST(0)                                                                                                                                                                                                                                                                                                                                                                                                                                                                                                                                                                                                                                                                                                                                                                                              |                     |                                        |                     |                            |                   |                           |                  |                    |                  |                    |
| FIADD <i>m16int</i> | Add <i>m16int</i> to ST(0)                                                                                                                                                                                                                                                                                                                                                                                                                                                                                                                                                                                                                                                                                                                                                                                              |                     |                                        |                     |                            |                   |                           |                  |                    |                  |                    |
| FBLD                | <b>Load binary-coded decimal.</b> Converts BCD source operand into double extended-precision floating-point format and pushes it on the stack. Format: <table style="width: 100%; border: none; margin-top: 5px;"> <tr> <td style="padding: 2px 20px;">FBLD <i>m80bcd</i></td> <td style="padding: 2px 20px;">Push <i>m80bcd</i> onto register stack</td> </tr> </table>                                                                                                                                                                                                                                                                                                                                                                                                                                                | FBLD <i>m80bcd</i>  | Push <i>m80bcd</i> onto register stack |                     |                            |                   |                           |                  |                    |                  |                    |
| FBLD <i>m80bcd</i>  | Push <i>m80bcd</i> onto register stack                                                                                                                                                                                                                                                                                                                                                                                                                                                                                                                                                                                                                                                                                                                                                                                  |                     |                                        |                     |                            |                   |                           |                  |                    |                  |                    |



Table B-3 (Continued)

| Instruction          | Description                                                                                                                                                                                                                                                                                                                                                                                                                                                                                                                                                                                                                                                                                                                                                                                                                                                                                                                                                                                                                                             |                    |                                     |                    |                               |                     |                              |                    |                        |                     |                       |                     |                   |                      |                            |                     |                       |
|----------------------|---------------------------------------------------------------------------------------------------------------------------------------------------------------------------------------------------------------------------------------------------------------------------------------------------------------------------------------------------------------------------------------------------------------------------------------------------------------------------------------------------------------------------------------------------------------------------------------------------------------------------------------------------------------------------------------------------------------------------------------------------------------------------------------------------------------------------------------------------------------------------------------------------------------------------------------------------------------------------------------------------------------------------------------------------------|--------------------|-------------------------------------|--------------------|-------------------------------|---------------------|------------------------------|--------------------|------------------------|---------------------|-----------------------|---------------------|-------------------|----------------------|----------------------------|---------------------|-----------------------|
| FBSTP                | <p><b>Store BCD integer and pop.</b> Converts the value in the ST(0) register to an 18-digit packed BCD integer, stores the result in the destination operand, and pops the register stack. Format:</p> <p style="text-align: center;">FBSTP <i>m80bcd</i> Store ST(0) into <i>m80bcd</i>, and pop stack</p>                                                                                                                                                                                                                                                                                                                                                                                                                                                                                                                                                                                                                                                                                                                                            |                    |                                     |                    |                               |                     |                              |                    |                        |                     |                       |                     |                   |                      |                            |                     |                       |
| FCHS                 | <p><b>Change sign.</b> Complements the sign of ST(0). No operands.</p>                                                                                                                                                                                                                                                                                                                                                                                                                                                                                                                                                                                                                                                                                                                                                                                                                                                                                                                                                                                  |                    |                                     |                    |                               |                     |                              |                    |                        |                     |                       |                     |                   |                      |                            |                     |                       |
| FCLEX                | <p><b>Clear exceptions.</b> Clears the floating-point exception flags (PE, UE, OE, ZE, DE, and IE), the exception summary status flag (ES), the stack fault flag (SF), and the busy flag (B) in the FPU status word. No operands. FNCLEX performs the same operation without checking for pending unmasked floating-point exceptions.</p>                                                                                                                                                                                                                                                                                                                                                                                                                                                                                                                                                                                                                                                                                                               |                    |                                     |                    |                               |                     |                              |                    |                        |                     |                       |                     |                   |                      |                            |                     |                       |
| FCMOV $cc$           | <p><b>Floating-point conditional move.</b> Tests status flags in EFLAGS, moves source operand (second operand) to the destination operand (first operand) if the given test condition is true. Formats:</p> <table style="width: 100%; border: none;"> <tr> <td style="padding-left: 2em;">FCMOVB ST(0),ST(i)</td> <td>Move if below</td> </tr> <tr> <td style="padding-left: 2em;">FCMOVE ST(0),ST(i)</td> <td>Move if equal</td> </tr> <tr> <td style="padding-left: 2em;">FCMOVBE ST(0),ST(i)</td> <td>Move if below or equal</td> </tr> <tr> <td style="padding-left: 2em;">FCMOVU ST(0),ST(i)</td> <td>Move if unordered</td> </tr> <tr> <td style="padding-left: 2em;">FCMOVNB ST(0),ST(i)</td> <td>Move if not below</td> </tr> <tr> <td style="padding-left: 2em;">FCMOVNE ST(0),ST(i)</td> <td>Move if not equal</td> </tr> <tr> <td style="padding-left: 2em;">FCMOVNBE ST(0),ST(i)</td> <td>Move if not below or equal</td> </tr> <tr> <td style="padding-left: 2em;">FCMOVNU ST(0),ST(i)</td> <td>Move if not unordered</td> </tr> </table> | FCMOVB ST(0),ST(i) | Move if below                       | FCMOVE ST(0),ST(i) | Move if equal                 | FCMOVBE ST(0),ST(i) | Move if below or equal       | FCMOVU ST(0),ST(i) | Move if unordered      | FCMOVNB ST(0),ST(i) | Move if not below     | FCMOVNE ST(0),ST(i) | Move if not equal | FCMOVNBE ST(0),ST(i) | Move if not below or equal | FCMOVNU ST(0),ST(i) | Move if not unordered |
| FCMOVB ST(0),ST(i)   | Move if below                                                                                                                                                                                                                                                                                                                                                                                                                                                                                                                                                                                                                                                                                                                                                                                                                                                                                                                                                                                                                                           |                    |                                     |                    |                               |                     |                              |                    |                        |                     |                       |                     |                   |                      |                            |                     |                       |
| FCMOVE ST(0),ST(i)   | Move if equal                                                                                                                                                                                                                                                                                                                                                                                                                                                                                                                                                                                                                                                                                                                                                                                                                                                                                                                                                                                                                                           |                    |                                     |                    |                               |                     |                              |                    |                        |                     |                       |                     |                   |                      |                            |                     |                       |
| FCMOVBE ST(0),ST(i)  | Move if below or equal                                                                                                                                                                                                                                                                                                                                                                                                                                                                                                                                                                                                                                                                                                                                                                                                                                                                                                                                                                                                                                  |                    |                                     |                    |                               |                     |                              |                    |                        |                     |                       |                     |                   |                      |                            |                     |                       |
| FCMOVU ST(0),ST(i)   | Move if unordered                                                                                                                                                                                                                                                                                                                                                                                                                                                                                                                                                                                                                                                                                                                                                                                                                                                                                                                                                                                                                                       |                    |                                     |                    |                               |                     |                              |                    |                        |                     |                       |                     |                   |                      |                            |                     |                       |
| FCMOVNB ST(0),ST(i)  | Move if not below                                                                                                                                                                                                                                                                                                                                                                                                                                                                                                                                                                                                                                                                                                                                                                                                                                                                                                                                                                                                                                       |                    |                                     |                    |                               |                     |                              |                    |                        |                     |                       |                     |                   |                      |                            |                     |                       |
| FCMOVNE ST(0),ST(i)  | Move if not equal                                                                                                                                                                                                                                                                                                                                                                                                                                                                                                                                                                                                                                                                                                                                                                                                                                                                                                                                                                                                                                       |                    |                                     |                    |                               |                     |                              |                    |                        |                     |                       |                     |                   |                      |                            |                     |                       |
| FCMOVNBE ST(0),ST(i) | Move if not below or equal                                                                                                                                                                                                                                                                                                                                                                                                                                                                                                                                                                                                                                                                                                                                                                                                                                                                                                                                                                                                                              |                    |                                     |                    |                               |                     |                              |                    |                        |                     |                       |                     |                   |                      |                            |                     |                       |
| FCMOVNU ST(0),ST(i)  | Move if not unordered                                                                                                                                                                                                                                                                                                                                                                                                                                                                                                                                                                                                                                                                                                                                                                                                                                                                                                                                                                                                                                   |                    |                                     |                    |                               |                     |                              |                    |                        |                     |                       |                     |                   |                      |                            |                     |                       |
| FCOM                 | <p><b>Compare floating-point values.</b> Compares ST(0) to the source operand and sets condition code flags C0, C2, and C3 in the FPU status word according to the results. Formats:</p> <table style="width: 100%; border: none;"> <tr> <td style="padding-left: 2em;">FCOM <i>m32fp</i></td> <td>Compare ST(0) to <i>m32fp</i></td> </tr> <tr> <td style="padding-left: 2em;">FCOM <i>m64fp</i></td> <td>Compare ST(0) to <i>m64fp</i></td> </tr> <tr> <td style="padding-left: 2em;">FCOM ST(i)</td> <td>Compare ST(0) to ST(i)</td> </tr> <tr> <td style="padding-left: 2em;">FCOM</td> <td>Compare ST(0) to ST(1)</td> </tr> </table> <p>FCOMP performs the same operation as FCOM and then pops the stack. FCOMP does the same task as FCOM and then pops the stack twice. FUCOM, FUCOMP, and FUCOMPP are the same as FCOM, FCOMP, and FCOMP, respectively, except that they check for unordered values.</p>                                                                                                                                      | FCOM <i>m32fp</i>  | Compare ST(0) to <i>m32fp</i>       | FCOM <i>m64fp</i>  | Compare ST(0) to <i>m64fp</i> | FCOM ST(i)          | Compare ST(0) to ST(i)       | FCOM               | Compare ST(0) to ST(1) |                     |                       |                     |                   |                      |                            |                     |                       |
| FCOM <i>m32fp</i>    | Compare ST(0) to <i>m32fp</i>                                                                                                                                                                                                                                                                                                                                                                                                                                                                                                                                                                                                                                                                                                                                                                                                                                                                                                                                                                                                                           |                    |                                     |                    |                               |                     |                              |                    |                        |                     |                       |                     |                   |                      |                            |                     |                       |
| FCOM <i>m64fp</i>    | Compare ST(0) to <i>m64fp</i>                                                                                                                                                                                                                                                                                                                                                                                                                                                                                                                                                                                                                                                                                                                                                                                                                                                                                                                                                                                                                           |                    |                                     |                    |                               |                     |                              |                    |                        |                     |                       |                     |                   |                      |                            |                     |                       |
| FCOM ST(i)           | Compare ST(0) to ST(i)                                                                                                                                                                                                                                                                                                                                                                                                                                                                                                                                                                                                                                                                                                                                                                                                                                                                                                                                                                                                                                  |                    |                                     |                    |                               |                     |                              |                    |                        |                     |                       |                     |                   |                      |                            |                     |                       |
| FCOM                 | Compare ST(0) to ST(1)                                                                                                                                                                                                                                                                                                                                                                                                                                                                                                                                                                                                                                                                                                                                                                                                                                                                                                                                                                                                                                  |                    |                                     |                    |                               |                     |                              |                    |                        |                     |                       |                     |                   |                      |                            |                     |                       |
| FCOMI                | <p><b>Compare floating-point values and set EFLAGS.</b> Performs an unordered comparison of registers ST(0) and ST(i) and sets the status flags (ZF, PF, CF) in the EFLAGS register according to the results. Format:</p> <p style="text-align: center;">FCOMI ST(0),ST(i) Compare ST(0) to ST(i)</p> <p>FUCOMI does the same task as FCOMI and then pops the stack. FUCOMI and FUCOMIP check for unordered values.</p>                                                                                                                                                                                                                                                                                                                                                                                                                                                                                                                                                                                                                                 |                    |                                     |                    |                               |                     |                              |                    |                        |                     |                       |                     |                   |                      |                            |                     |                       |
| FCOS                 | <p><b>Cosine.</b> Computes the cosine of ST(0) and stores the result in ST(0). Input must be in radians. No operands.</p>                                                                                                                                                                                                                                                                                                                                                                                                                                                                                                                                                                                                                                                                                                                                                                                                                                                                                                                               |                    |                                     |                    |                               |                     |                              |                    |                        |                     |                       |                     |                   |                      |                            |                     |                       |
| FDECSTP              | <p><b>Decrement stack-top pointer.</b> Subtracts 1 from the TOP field of the FPU status word, effectively rotating the stack. No operands.</p>                                                                                                                                                                                                                                                                                                                                                                                                                                                                                                                                                                                                                                                                                                                                                                                                                                                                                                          |                    |                                     |                    |                               |                     |                              |                    |                        |                     |                       |                     |                   |                      |                            |                     |                       |
| FDIV                 | <p><b>Divide floating-point and pop.</b> Divides the destination operand by the source operand and stores the result in the destination location. Formats:</p> <table style="width: 100%; border: none;"> <tr> <td style="padding-left: 2em;">FDIV</td> <td>ST(1) = ST(1) / T(0), and pop stack</td> </tr> <tr> <td style="padding-left: 2em;">FDIV <i>m32fp</i></td> <td>ST(0) = ST(0) / <i>m32fp</i></td> </tr> <tr> <td style="padding-left: 2em;">FDIV <i>m64fp</i></td> <td>ST(0) = ST(0) / <i>m64fp</i></td> </tr> <tr> <td style="padding-left: 2em;">FDIV ST(0),ST(i)</td> <td>ST(0) = ST(0) / ST(i)</td> </tr> <tr> <td style="padding-left: 2em;">FDIV ST(i),ST(0)</td> <td>ST(i) = ST(i) / ST(0)</td> </tr> </table>                                                                                                                                                                                                                                                                                                                         | FDIV               | ST(1) = ST(1) / T(0), and pop stack | FDIV <i>m32fp</i>  | ST(0) = ST(0) / <i>m32fp</i>  | FDIV <i>m64fp</i>   | ST(0) = ST(0) / <i>m64fp</i> | FDIV ST(0),ST(i)   | ST(0) = ST(0) / ST(i)  | FDIV ST(i),ST(0)    | ST(i) = ST(i) / ST(0) |                     |                   |                      |                            |                     |                       |
| FDIV                 | ST(1) = ST(1) / T(0), and pop stack                                                                                                                                                                                                                                                                                                                                                                                                                                                                                                                                                                                                                                                                                                                                                                                                                                                                                                                                                                                                                     |                    |                                     |                    |                               |                     |                              |                    |                        |                     |                       |                     |                   |                      |                            |                     |                       |
| FDIV <i>m32fp</i>    | ST(0) = ST(0) / <i>m32fp</i>                                                                                                                                                                                                                                                                                                                                                                                                                                                                                                                                                                                                                                                                                                                                                                                                                                                                                                                                                                                                                            |                    |                                     |                    |                               |                     |                              |                    |                        |                     |                       |                     |                   |                      |                            |                     |                       |
| FDIV <i>m64fp</i>    | ST(0) = ST(0) / <i>m64fp</i>                                                                                                                                                                                                                                                                                                                                                                                                                                                                                                                                                                                                                                                                                                                                                                                                                                                                                                                                                                                                                            |                    |                                     |                    |                               |                     |                              |                    |                        |                     |                       |                     |                   |                      |                            |                     |                       |
| FDIV ST(0),ST(i)     | ST(0) = ST(0) / ST(i)                                                                                                                                                                                                                                                                                                                                                                                                                                                                                                                                                                                                                                                                                                                                                                                                                                                                                                                                                                                                                                   |                    |                                     |                    |                               |                     |                              |                    |                        |                     |                       |                     |                   |                      |                            |                     |                       |
| FDIV ST(i),ST(0)     | ST(i) = ST(i) / ST(0)                                                                                                                                                                                                                                                                                                                                                                                                                                                                                                                                                                                                                                                                                                                                                                                                                                                                                                                                                                                                                                   |                    |                                     |                    |                               |                     |                              |                    |                        |                     |                       |                     |                   |                      |                            |                     |                       |

Table B-3 (Continued)

| Instruction | Description                                                                                                                                                                                                                                                                                                                                                                                                                                                                                                                                       |
|-------------|---------------------------------------------------------------------------------------------------------------------------------------------------------------------------------------------------------------------------------------------------------------------------------------------------------------------------------------------------------------------------------------------------------------------------------------------------------------------------------------------------------------------------------------------------|
| FDIVP       | <p><b>Divide floating-point and pop.</b> Same as FDIV, then pops from the stack. Format:</p> <p style="text-align: center;">FDIVP <i>ST(i),ST(0)</i>    <math>ST(i) = ST(i) / ST(0)</math>, and pop stack</p>                                                                                                                                                                                                                                                                                                                                     |
| FIDIV       | <p><b>Convert integer to floating-point and divide.</b> After converting, performs the same operation as FDIV. Formats:</p> <p style="text-align: center;">FIDIV <i>m32int</i>            <math>ST(0) = ST(0) / m32int</math><br/> FIDIV <i>m16int</i>            <math>ST(0) = ST(0) / m16int</math></p>                                                                                                                                                                                                                                         |
| FDIVR       | <p><b>Reverse divide.</b> Divides the source operand by the destination operand and stores the result in the destination location. Formats:</p> <p style="text-align: center;">FDIVR                    <math>ST(0) = ST(0) / ST(1)</math>, and pop stack<br/> FDIVR <i>m32fp</i>            <math>ST(0) = m32fp / ST(0)</math><br/> FDIVR <i>m64fp</i>            <math>ST(0) = m64fp / ST(0)</math><br/> FDIVR <i>ST(0),ST(i)</i>    <math>ST(0) = ST(i) / ST(0)</math><br/> FDIVR <i>ST(i),ST(0)</i>    <math>ST(i) = ST(0) / ST(i)</math></p> |
| FDIVRP      | <p><b>Reverse divide and pop.</b> Performs the same operation as FDIVR, then pops from the stack. Format:</p> <p style="text-align: center;">FDIVRP <i>ST(i),ST(0)</i>    <math>ST(i) = ST(0) / ST(i)</math>, and pop stack</p>                                                                                                                                                                                                                                                                                                                   |
| FIDIVR      | <p><b>Convert integer to float and perform reverse divide.</b> After converting, performs the same operation as FDIVR. Formats:</p> <p style="text-align: center;">FIDIVR <i>m32int</i>            <math>ST(0) = m32int / ST(0)</math><br/> FIDIVR <i>m16int</i>            <math>ST(0) = m16int / ST(0)</math></p>                                                                                                                                                                                                                               |
| FFREE       | <p><b>Free floating-point register.</b> Sets the register to empty, using Tag word. Format:</p> <p style="text-align: center;">FFREE <i>ST(i)</i>            <math>ST(i) = \text{empty}</math></p>                                                                                                                                                                                                                                                                                                                                                |
| FICOM       | <p><b>Compare integer.</b> Compares the value in <i>ST(0)</i> with an integer source operand and sets the condition code flags C0, C2, and C3 according to the results. The integer source operand is converted to floating-point before the comparison. Formats:</p> <p style="text-align: center;">FICOM <i>m32int</i>            Compare <i>ST(0)</i> to <i>m32int</i><br/> FICOM <i>m16int</i>            Compare <i>ST(0)</i> to <i>m16int</i></p> <p>FICOMP performs the same operation as FICOM, then pops from the stack.</p>             |
| FILD        | <p><b>Convert integer to float and load onto register stack.</b> Formats:</p> <p style="text-align: center;">FILD <i>m16int</i>            Push <i>m16int</i> onto register stack<br/> FILD <i>m32int</i>            Push <i>m32int</i> onto register stack<br/> FILD <i>m64int</i>            Push <i>m64int</i> onto register stack</p>                                                                                                                                                                                                         |
| FINCSTP     | <p><b>Increment stack-top pointer.</b> Adds 1 to the TOP field of the FPU status word. No operands.</p>                                                                                                                                                                                                                                                                                                                                                                                                                                           |
| FINIT       | <p><b>Initialize floating-point unit.</b> Sets the control, status, tag, instruction pointer, and data pointer registers to their default states. The control word is set to 037FH (round to nearest, all exceptions masked, 64-bit precision). The status word is cleared (no exception flags set, TOP = 0). The data registers in the register stack are unchanged, but they are tagged as empty. No operands. FNINIT performs the same operation without checking for pending unmasked floating-point exceptions.</p>                          |

Table B-3 (Continued)

| Instruction | Description                                                                                                                                                                                                                                                                                                                                                                                                                                                                                                                                                                                                                                                                                                                           |
|-------------|---------------------------------------------------------------------------------------------------------------------------------------------------------------------------------------------------------------------------------------------------------------------------------------------------------------------------------------------------------------------------------------------------------------------------------------------------------------------------------------------------------------------------------------------------------------------------------------------------------------------------------------------------------------------------------------------------------------------------------------|
| FIST        | <p><b>Store integer in memory operand.</b> Stores ST(0) in a signed integer memory operand, rounding according to the RC field in the FPU control word. Formats:</p> <p style="padding-left: 40px;">FIST <i>m16int</i>                      Store ST(0) in <i>m16int</i></p> <p style="padding-left: 40px;">FIST <i>m32int</i>                      Store ST(0) in <i>m32int</i></p> <p>FISTP performs the same operation as FIST, then pops the register stack. It has one additional format:</p> <p style="padding-left: 40px;">FISTP <i>m64int</i>                      Store ST(0) in <i>m64int</i>, and pop stack</p>                                                                                                            |
| FISTTP      | <p><b>Store integer with truncation.</b> Performs same operation as FIST, but automatically truncates the integer and pops the stack. Formats:</p> <p style="padding-left: 40px;">FISTTP <i>m16int</i>                      Store ST(0) in <i>m16int</i>, and pop stack</p> <p style="padding-left: 40px;">FISTTP <i>m32int</i>                      Store ST(0) in <i>m32int</i>, and pop stack</p> <p style="padding-left: 40px;">FISTTP <i>m64int</i>                      Store ST(0) in <i>m64int</i>, and pop stack</p>                                                                                                                                                                                                         |
| FLD         | <p><b>Load floating-point value onto register stack.</b> Formats:</p> <p style="padding-left: 40px;">FLD <i>m32fp</i>                          Push <i>m32fp</i> onto register stack</p> <p style="padding-left: 40px;">FLD <i>m64fp</i>                          Push <i>m64fp</i> onto register stack</p> <p style="padding-left: 40px;">FLD <i>m80fp</i>                          Push <i>m80fp</i> onto register stack</p> <p style="padding-left: 40px;">FLD ST(<i>i</i>)                            Push ST(<i>i</i>) onto register stack</p>                                                                                                                                                                                   |
| FLD1        | <b>Load +1.0 onto register stack.</b> No operands.                                                                                                                                                                                                                                                                                                                                                                                                                                                                                                                                                                                                                                                                                    |
| FLDL2T      | <b>Load log<sub>2</sub> 10 onto register stack.</b> No operands.                                                                                                                                                                                                                                                                                                                                                                                                                                                                                                                                                                                                                                                                      |
| FLDL2E      | <b>Load log<sub>2</sub> <i>e</i> onto register stack.</b> No operands.                                                                                                                                                                                                                                                                                                                                                                                                                                                                                                                                                                                                                                                                |
| FLDPI       | <b>Load <i>pi</i> onto register stack.</b> No operands.                                                                                                                                                                                                                                                                                                                                                                                                                                                                                                                                                                                                                                                                               |
| FLDLG2      | <b>Load log<sub>10</sub> 2 onto register stack.</b> No operands.                                                                                                                                                                                                                                                                                                                                                                                                                                                                                                                                                                                                                                                                      |
| FLDLN2      | <b>Load log<sub>e</sub> 2 onto register stack.</b> No operands.                                                                                                                                                                                                                                                                                                                                                                                                                                                                                                                                                                                                                                                                       |
| FLDZ        | <b>Load +0.0 onto register stack.</b> No operands.                                                                                                                                                                                                                                                                                                                                                                                                                                                                                                                                                                                                                                                                                    |
| FLDCW       | <p><b>Load FPU control word from 16-bit memory value.</b> Format:</p> <p style="padding-left: 40px;">FLDCW <i>m2byte</i>                      Load FPU control word from <i>m2byte</i></p>                                                                                                                                                                                                                                                                                                                                                                                                                                                                                                                                            |
| FLDENV      | <p><b>Load FPU environment from memory into the FPU.</b> Format:</p> <p style="padding-left: 40px;">FLDENV <i>m14/28byte</i>                      Load FPU environment from memory</p>                                                                                                                                                                                                                                                                                                                                                                                                                                                                                                                                                |
| FMUL        | <p><b>Multiply floating-point.</b> Multiplies the destination and source operands and stores the product in the destination location. Formats:</p> <p style="padding-left: 40px;">FMUL                                      ST(1) = ST(1) * ST(0), and pop stack</p> <p style="padding-left: 40px;">FMUL <i>m32fp</i>                              ST(0) = ST(0) * <i>m32fp</i></p> <p style="padding-left: 40px;">FMUL <i>m64fp</i>                              ST(0) = ST(0) * <i>m64fp</i></p> <p style="padding-left: 40px;">FMUL ST(0), ST(<i>i</i>)                      ST(0) = ST(0) * ST(<i>i</i>)</p> <p style="padding-left: 40px;">FMUL ST(<i>i</i>), ST(0)                      ST(<i>i</i>) = ST(<i>i</i>) * ST(0)</p> |
| FMULP       | <p><b>Multiply floating-point and pop.</b> Performs the same operation as FMUL, then pops the stack. Format:</p> <p style="padding-left: 40px;">FMULP ST(<i>i</i>), ST(0)                      ST(<i>i</i>) = ST(<i>i</i>) * ST(0), and pop stack</p>                                                                                                                                                                                                                                                                                                                                                                                                                                                                                 |

Table B-3 (Continued)

| Instruction | Description                                                                                                                                                                                                                                                                                                                                              |
|-------------|----------------------------------------------------------------------------------------------------------------------------------------------------------------------------------------------------------------------------------------------------------------------------------------------------------------------------------------------------------|
| FIMUL       | <p><b>Convert integer and multiply.</b> Converts the source operand to floating-point, multiplies it by ST(0), and stores the product in ST(0). Formats:</p> <pre>FIMUL m16int FIMUL m32int</pre>                                                                                                                                                        |
| FNOP        | <p><b>No operation.</b> No operands.</p>                                                                                                                                                                                                                                                                                                                 |
| FPATAN      | <p><b>Partial arctangent.</b> Replaces ST(1) with <math>\arctan(\text{ST}(1)/\text{ST}(0))</math> and pops the register stack. No operands.</p>                                                                                                                                                                                                          |
| FPREM       | <p><b>Partial remainder.</b> Replaces ST(0) with the remainder obtained from dividing ST(0) by ST(1). No operands. FPREM1 is similar, replacing ST(0) with the IEEE remainder obtained from dividing ST(0) by ST(1).</p>                                                                                                                                 |
| FPTAN       | <p><b>Partial tangent.</b> Replaces ST(0) with its tangent and pushes 1.0 onto the FPU stack. Input must be in radians. No operands.</p>                                                                                                                                                                                                                 |
| FRNDINT     | <p><b>Round to integer.</b> Rounds ST(0) to the nearest integer value. No operands.</p>                                                                                                                                                                                                                                                                  |
| FRSTOR      | <p><b>Restore x87 FPU State.</b> Loads the FPU state (operating environment and register stack) from the memory area specified by the source operand. Format:</p> <pre>FRSTOR m94/108byte</pre>                                                                                                                                                          |
| FSAVE       | <p><b>Store x87 FPU State.</b> Stores the current FPU state (operating environment and register stack) in memory specified by the destination operand and then reinitializes the FPU. Format:</p> <pre>FSAVE m94/108byte</pre> <p>FNSAVE performs the same operation without checking for pending unmasked floating-point exceptions.</p>                |
| FSCALE      | <p><b>Scale.</b> Truncates the value in ST(1) to an integral value and adds that value to the exponent of the destination operand ST(0). No operands.</p>                                                                                                                                                                                                |
| FSIN        | <p><b>Sine.</b> Replaces ST(0) with its sine. Input must be in radians. No operands.</p>                                                                                                                                                                                                                                                                 |
| FSINCOS     | <p><b>Sine and cosine.</b> Computes the sine and cosine of ST(0). Input must be in radians. Replaces ST(0) with the sine and pushes the cosine on the register stack. No operands.</p>                                                                                                                                                                   |
| FSQRT       | <p><b>Square root.</b> Replaces ST(0) with its square root. No operands.</p>                                                                                                                                                                                                                                                                             |
| FST         | <p><b>Store floating-point value.</b> Formats:</p> <pre>FST m32fp          Copy ST(0) to m32fp FST m64fp          Copy ST(0) to m64fp FST ST(i)          Copy ST(0) to ST(i)</pre> <p>FSTP performs the same operation as FST, then pops the stack. It has one additional format:</p> <pre>FSTP m80fp          Copy ST(0) to m80fp, and pop stack</pre>  |
| FSTCW       | <p><b>Store FPU control word.</b> Format:</p> <pre>FLDCW m2byte      Store FPU control word to m2byte</pre> <p>FNSTCW performs the same operation without checking for pending unmasked floating-point exceptions.</p>                                                                                                                                   |
| FSTENV      | <p><b>Store FPU environment.</b> Stores the FPU environment in a m14byte or m28byte structure, depending on whether the processor is in real mode or protected mode. Format:</p> <pre>FSTENV memop      Store FPU environment to memop</pre> <p>FNSTENV performs the same operation without checking for pending unmasked floating-point exceptions.</p> |

Table B-3 (Continued)

| Instruction | Description                                                                                                                                                                                                                                                                                                                                                                                                                                                                                                                                                                                                                                                                      |
|-------------|----------------------------------------------------------------------------------------------------------------------------------------------------------------------------------------------------------------------------------------------------------------------------------------------------------------------------------------------------------------------------------------------------------------------------------------------------------------------------------------------------------------------------------------------------------------------------------------------------------------------------------------------------------------------------------|
| FSTSW       | <p><b>Store FPU status word.</b> Formats:</p> <p style="padding-left: 40px;">FSTSW <i>m2byte</i>      Store FPU status word to <i>m2byte</i></p> <p style="padding-left: 40px;">FSTSW AX              Store FPU status word to AX register</p> <p>FNSTSW performs the same operation without checking for pending unmasked floating-point exceptions.</p>                                                                                                                                                                                                                                                                                                                        |
| FSUB        | <p><b>Subtract floating-point.</b> Subtracts the source operand from the destination operand and stores the difference in the destination location. Formats:</p> <p style="padding-left: 40px;">FSUB                      ST(0) = ST(1) – ST(0), and pop stack</p> <p style="padding-left: 40px;">FSUB <i>m32fp</i>              ST(0) = ST(0) – <i>m32fp</i></p> <p style="padding-left: 40px;">FSUB <i>m64fp</i>              ST(0) = ST(0) – <i>m64fp</i></p> <p style="padding-left: 40px;">FSUB ST(0), ST(<i>i</i>)      ST(0) = ST(0) – ST(<i>i</i>)</p> <p style="padding-left: 40px;">FSUB ST(<i>i</i>), ST(0)      ST(<i>i</i>) = ST(<i>i</i>) – ST(0)</p>              |
| FSUBP       | <p><b>Subtract floating-point and pop.</b> The FSUBP instruction performs the same operation as FSUB, then pops the stack. Format:</p> <p style="padding-left: 40px;">FSUBP ST(<i>i</i>), ST(0)    ST(<i>i</i>) = ST(<i>i</i>) – ST(0), and pop stack</p>                                                                                                                                                                                                                                                                                                                                                                                                                        |
| FISUB       | <p><b>Convert integer to floating-point and subtract.</b> Converts source operand to floating-point, subtracts it from ST(0), and stores the result in ST(0). Formats:</p> <p style="padding-left: 40px;">FISUB <i>m16int</i>              ST(0) = ST(0) – <i>m16int</i></p> <p style="padding-left: 40px;">FISUB <i>m32int</i>              ST(0) = ST(0) – <i>m32int</i></p>                                                                                                                                                                                                                                                                                                   |
| FSUBR       | <p><b>Reverse subtract floating-point.</b> Subtracts the destination operand from the source operand and stores the difference in the destination location. Formats:</p> <p style="padding-left: 40px;">FSUBR                      ST(0) = ST(0) – ST(1), and pop stack</p> <p style="padding-left: 40px;">FSUBR <i>m32fp</i>              ST(0) = <i>m32fp</i> – ST(0)</p> <p style="padding-left: 40px;">FSUBR <i>m64fp</i>              ST(0) = <i>m64fp</i> – ST(0)</p> <p style="padding-left: 40px;">FSUBR ST(0), ST(<i>i</i>)      ST(0) = ST(<i>i</i>) – ST(0)</p> <p style="padding-left: 40px;">FSUBR ST(<i>i</i>), ST(0)      ST(<i>i</i>) = ST(0) – ST(<i>i</i>)</p> |
| FSUBRP      | <p><b>Reverse subtract floating-point and pop.</b> The FSUBRP instruction performs the same operation as FSUBR, then pops the stack. Format:</p> <p style="padding-left: 40px;">FSUBRP ST(<i>i</i>), ST(0)    ST(<i>i</i>) = ST(0) – ST(<i>i</i>), and pop stack</p>                                                                                                                                                                                                                                                                                                                                                                                                             |
| FISUBR      | <p><b>Convert integer and reverse subtract floating-point.</b> After converting to floating-point, performs the same operation as FSUBR. Formats:</p> <p style="padding-left: 40px;">FISUBR <i>m16int</i></p> <p style="padding-left: 40px;">FISUBR <i>m32int</i></p>                                                                                                                                                                                                                                                                                                                                                                                                            |
| FTST        | <p><b>Test.</b> Compares ST(0) to 0.0 and sets condition code flags in the FPU status word. No operands.</p>                                                                                                                                                                                                                                                                                                                                                                                                                                                                                                                                                                     |
| FWAIT       | <p><b>Wait.</b> Waits for all pending floating-point exception handlers to complete. No operands.</p>                                                                                                                                                                                                                                                                                                                                                                                                                                                                                                                                                                            |
| FXAM        | <p><b>Examine.</b> Examines ST(0) and sets condition code flags in the FPU status word. No operands.</p>                                                                                                                                                                                                                                                                                                                                                                                                                                                                                                                                                                         |
| FXCH        | <p><b>Exchange register contents.</b> Formats:</p> <p style="padding-left: 40px;">FXCH ST(<i>i</i>)              Exchange ST(0) and ST(<i>i</i>)</p> <p style="padding-left: 40px;">FXCH                      Exchange ST(0) and ST(1)</p>                                                                                                                                                                                                                                                                                                                                                                                                                                       |

Table B-3 (Continued)

| Instruction | Description                                                                                                                                                                                                                                                                     |
|-------------|---------------------------------------------------------------------------------------------------------------------------------------------------------------------------------------------------------------------------------------------------------------------------------|
| FXRSTOR     | <p><b>Restore x87 FPU, MMX Technology, SSE, and SSE2 State.</b> Reloads the FPU, MMX technology, XMM, and MXCSR registers from the memory image specified in the source operand. Format:</p> <p style="text-align: center;"><code>FXRSTOR m512byte</code></p>                   |
| FXSAVE      | <p><b>Save x87 FPU, MMX Technology, SSE, and SSE2 State.</b> Saves the current state of the FPU, MMX technology, XMM, and MXCSR registers to the memory image specified in the destination operand. Format:</p> <p style="text-align: center;"><code>FXSAVE m512byte</code></p> |
| FXTRACT     | <p><b>Extract exponent and significand.</b> Separates the source in ST(0) into its exponent and significand, stores the exponent in ST(0), and pushes the significand on the register stack. No operands.</p>                                                                   |
| FYL2X       | <p><b>Compute <math>y * \log_2 x</math>.</b> Register ST(1) holds the value of y, and ST(0) holds the value of x. Stack is popped, so the result is left in ST(0). No operands.</p>                                                                                             |
| FYL2XP1     | <p><b>Compute <math>y * \log_2(x + 1)</math>.</b> Register ST(1) holds the value of y, and ST(0) holds the value of x. Stack is popped, so the result is left in ST(0). No operands.</p>                                                                                        |

---

# ANSWERS TO SECTION REVIEW QUESTIONS

The answers given here refer to *Section Review* questions, which are found at the end of each major section within the chapters. These are not answers to the *Chapter Review* questions, which appear only at the end of each chapter. Those answers may be found in the Instructor Supplements for this book, available at the Pearson Education web site.

## 1 Basic Concepts

### 1.1 Welcome to Assembly Language

1. An assembler converts source-code programs from assembly language into machine language. A linker combines individual files created by an assembler into a single executable program.
2. Assembly language is a good tool for learning how application programs communicate with the computer's operating system via interrupt handlers, system calls, and common memory areas. Assembly language programming also helps when learning how the operating system loads and executes application programs.
3. In a *one-to-many* relationship, a single statement expands into multiple assembly language or machine instructions.
4. A language whose source programs can be compiled and run on a wide variety of computer systems is said to be *portable*.
5. No. Each assembly language is based on either a processor family or a specific computer.
6. Some examples of embedded systems applications are automobile fuel and ignition systems, air-conditioning control systems, security systems, flight control systems, hand-held computers, modems, printers, and other intelligent computer peripherals.

7. *Device drivers* are programs that translate general operating system commands into specific references to hardware details that only the manufacturer knows.
8. C++ does not allow a pointer of one type to be assigned to a pointer of another type. Assembly language has no such restriction regarding pointers.
9. Applications suited to assembly language: hardware device driver and embedded systems and computer games requiring direct hardware access.
10. A high-level language may not provide for direct hardware access. Even if it does, awkward coding techniques must often be used, resulting in possible maintenance problems.
11. Assembly language has minimal formal structure, so structure must be imposed by programmers who have varying levels of experience. This leads to difficulties maintaining existing code.
12. Code for the expression  $X = (Y * 4) + 3$ :

```

mov   eax, Y           ; move Y to EAX
mov   ebx, 4           ; move 4 to EBX
imul  ebx             ; EAX = EAX * EBX
add   eax, 3           ; add 3 to EAX
mov   X, eax           ; move EAX to X

```

## 1.2 Virtual Machine Concept

1. Virtual machine concept: Computers are constructed in layers, so that each layer represents a translation layer from a higher-level instruction set to a lower-level instruction set.
2. A translated program is often faster because it is coded in a language that can be directly executed on the target machine. This is not the case with interpreted programs, since they must be translated while they are running.
3. True.
4. An entire L1 program is converted into an L0 program by an L0 program specifically designed for this purpose. Then the resulting L0 program is executed directly on the computer hardware.
5. Assembly language appears at Level 3.
6. The Java virtual machine (JVM) allows compiled Java programs to run on almost any computer.
7. Digital logic, instruction set architecture, assembly language, high-level language.
8. Machine language is difficult for humans to understand, since it provides no visual clues relating to the instruction syntax.
9. Instruction set architecture.
10. Level 2 (Instruction Set Architecture).

## 1.3 Data Representation

1. The Least Significant Bit is position 0, having the value of 2 to the zero power.
2. (a) 248 (b) 202 (c) 240
3. (a) 00010001 (b) 101000000 (c) 00011110



4. (a) 2 (b) 4 (c) 8 (d) 16
5. (a) decimal 65 requires 7 bits (b) decimal 409 requires 9 bits  
(c) decimal 16,385 requires 15 bits
6. (a) 35DA (b) CEA3 (c) FEDB
7. (a) A4693FBC = 1010 0100 0110 1001 0011 1111 1011 1100  
(b) B697C7A1 = 1011 0110 1001 0111 1100 0111 1010 0001  
(c) 2B3D9461 = 0010 1011 0011 1101 1001 0100 0110 0001

## 1.4 Boolean Expressions

1. (NOT X) OR Y
2. X AND Y
3. T
4. F
5. T

## 2 x86 Processor Architecture Details

### 2.1 General Concepts

1. Control Unit, Arithmetic Logic Unit, and the clock.
2. Data, Address, and Control buses.
3. Conventional memory is outside the CPU and it responds more slowly to access requests.  
Registers are hard-wired inside the CPU.
4. Fetch, decode, execute.
5. Fetch memory operands, store memory operands.

### 2.2 x86 Architecture Details

1. Real-address mode, Protected mode, and System Management mode.
2. EAX, EBX, ECX, EDX, ESI, EDI, ESP, EBP.
3. CS, DS, SS, ES, FS, GS.
4. Loop counter.

### 2.3 64-Bit x86-64 Processors

No review questions.

### 2.4 Components of a Typical x86 Computer

1. SRAM is an acronym for Static RAM, used in CPU cache memory.
2. VRAM (video ram) holds displayable video data. When CRT monitors are used, VRAM is dual ported, allowing one port to continuously refresh the display while another port writes data to the display.

3. Select any two features from the following list: (1) Intel Fast Memory Access uses an updated Memory Controller Hub (MCH). (2) I/O Controller Hub (Intel ICH8/R/DH) that supports serial ATA devices (disk drives). (3) Support for 10 USB ports, 6 PCI express slots, networking, and Intel Quiet System technology. (4) High definition audio chip.
4. Dynamic RAM, Static RAM, Video RAM, and CMOS RAM.
5. The 8259A PIC controller handles external interrupts from hardware devices such as the keyboard, system clock, and disk drives.

## 2.5 Input–Output System

1. The application program level.
2. BIOS functions communicate directly with the system hardware. They are independent of the operating system.
3. New devices are invented all the time with capabilities that were often not anticipated when the BIOS was written.
4. The BIOS level.
5. No. The same BIOS would work for both operating systems. Many computer owners install two or three operating systems on the same computer. They would certainly not want to change the system BIOS every time they rebooted the computer!

## 3 Assembly Language Fundamentals

### 3.1 Basic Language Elements

1.  $-35d$ ,  $DDh$ ,  $335o$ ,  $11011101b$
2. No (a leading zero is required).
3. No (they have the same precedence)
4. Expression:  $30 \text{ MOD } (3 * 4) + (3 - 1) / 2 = 20$
5. Real number constant:  $-6.2E+04$
6. No, they can also be enclosed in double quotes.
7. Directives
8. 247 characters

### 3.2 Example: Adding and Subtracting Integers

1. The `INCLUDE` directive copies necessary definitions and setup information from the `Irvine32.inc` text file. The data from this file are inserted into the data stream read by the assembler.
2. The `.CODE` directive marks the beginning of the code segment.
3. Code and data.
4. `EAX`.
5. `INVOKE ExitProcess,0`.

### 3.3 Assembling, Linking, and Running Programs

1. Object (.OBJ) and listing (.LST) files
2. True
3. True
4. Loader
5. Executable (.EXE)

### 3.4 Defining Data

1. var1 SWORD ?
2. var2 BYTE ?
3. var3 SBYTE ?
4. var4 QWORD ?
5. SDWORD

### 3.5 Symbolic Constants

1. BACKSPACE = 08h
2. SecondsInDay = 24 \* 60 \* 60
3. ArraySize = (\$ - myArray)
4. ArraySize = (\$ - myArray) / 4
5. PROCEDURE TEXTEQU <PROC>
6. Code example:  

```
Sample TEXTEQU <"This is a string">
MyString BYTE Sample
```
7. SetupESI TEXTEQU <mov esi, OFFSET myArray>

### 3.6 64-Bit Programming

No review questions.

## 4 Data Transfers, Addressing, and Arithmetic

### 4.1 Data Transfer Instructions

1. Register, immediate, and memory.
2. False.
3. False.
4. True.
5. A 32-bit register or memory operand
6. A 16-bit immediate (constant) operand

## 4.2 Addition and Subtraction

1. inc val2
2. sub eax, val3
3. Code:  

```
mov ax, val4
sub val2, ax
```
4. CF = 0, SF = 1
5. OF = 1, SF = 1
6. Write down the following flag values:
  - (a) CF = 1, SF = 0, ZF = 1, OF = 0
  - (b) CF = 0, SF = 1, ZF = 0, OF = 1
  - (c) CF = 0, SF = 1, ZF = 0, OF = 0

## 4.3 Data-Related Operators and Directives

1. False
2. False
3. True
4. False
5. True

## 4.4 Indirect Addressing

1. True
2. False
3. True (the PTR operator is required)
4. True
5. (a) 10h (b) 40h (c) 003Bh (d) 3 (e) 3 (f) 2
6. (a) 2010h (b) 003B008Ah (c) 0 (d) 0 (e) 0044h

## 4.5 JMP and LOOP Instructions

1. True
2. False
3. 4,294,967,296 times
4. False
5. True
6. CX
7. ECX
8. False (-128 to +127 bytes from the current location)

9. This is a trick! The program does not stop, because the first LOOP instruction decrements ECX to zero. The second LOOP instruction decrements ECX to FFFFFFFFh, causing the outer loop to repeat.
10. Insert the following instruction at label L1: `push ecx`. Also insert the following instruction before the second LOOP instruction: `pop ecx`. (Once you have added these instructions, the final value of eax is 1Ch.)

## 4.6 64-Bit Programming

1. True (bits 8-63 are cleared)
2. False (64-bit constants are allowed)
3. RCX = 12345678FFFFFFFF hexadecimal
4. RCX = 12345678ABABABAB hexadecimal
5. AL = 1F hexadecimal
6. RCX = DF02 hexadecimal

## 5 Procedures

### 5.1 Stack Operations

1. ESP
2. The runtime stack is the only type of stack that is managed directly by the CPU. For example, it holds the return addresses of called procedures.
3. LIFO stands for “last in, first out.” The last value pushed into the stack is the first value popped out from the stack.
4. ESP is decremented by 4.
5. True
6. False

### 5.2 Defining and Using Procedures

1. True
2. False
3. Execution would continue beyond the end of the procedure, possibly into the beginning of another procedure. This type of programming bug is often difficult to detect!
4. `Receives` indicates the input parameters given to the procedure when it is called. `Returns` indicates what value, if any, the procedure produces when it returns it to its caller.
5. False (it pushes the offset of the instruction following the call).
6. True

### 5.3 Linking to an External Library

1. False (it contains object code).
2. Code example:
 

```
MyProc PROTO
```
3. Code example:
 

```
call MyProc
```
4. Irvine32.lib
5. Kernel32.dll is a dynamic link library that is a fundamental part of the MS-Windows operating system.

### 5.4 The Irvine32 Library

1. RandomRange procedure
2. WaitMsg procedure
3. Code example:
 

```
mov eax,700
call Delay
```
4. WriteDec procedure
5. Gotoxy procedure
6. INCLUDE Irvine32.inc
7. PROTO statements (procedure prototypes) and constant definitions. (There are also text macros, but they are not mentioned in this chapter.)
8. ESI contains the data's starting address, ECX contains the number of data units, and EBX contains the data unit size (byte, word, or doubleword).
9. EDX contains the offset of an array of bytes, and ECX contains the maximum number of characters to read.
10. Carry, Sign, Zero, Overflow, Auxiliary carry, and Parity.
11. Code example:

```
.data
str1 BYTE "Enter identification number: ",0
idStr BYTE 15 DUP(?)
.code
mov edx,OFFSET str1
call WriteString
mov edx,OFFSET idStr
mov ecx,(SIZEOF idStr) - 1
call ReadString
```

### 5.5 64-Bit Assembly Programming

No review questions.

## 6 Conditional Processing

### 6.1 Conditional Branching

No review questions.

### 6.2 Boolean and Comparison Instructions

1. `and ax,00FFh`
2. `or ax,0FF00h`
3. `xor eax,0FFFFFFFFh`
4. `test eax,1` ; (low bit set if eax is odd)
5. `or al,00100000b`

### 6.3 Conditional Loops

1. JA, JNBE, JAE, JNB, JB, JNAE, JBE, JNA
2. JG, JNLE, JGE, JNL, JL, JNGE, JLE, JNG
3. JB is equivalent to JNAE.
4. JBE
5. JL
6. No (8109h is negative and 26h is positive).

### 6.4 Conditional Loop Instructions

1. False
2. True
3. True
4. Code example:

```
.data
array SWORD 3,5,14,-3,-6,-1,-10,10,30,40,4
sentinel SWORD 0
.code
main PROC
    mov esi,OFFSET array
    mov ecx,LENGTHOF array
next:
    test WORD PTR [esi],8000h ; test sign bit
    pushfd                    ; push flags on stack
    add esi,TYPE array
    popfd                     ; pop flags from stack
    loopz next                ; continue loop while ZF=1
    jz quit                   ; none found
    sub esi,TYPE array        ; ESI points to value
```

5. If a matching value were not found, ESI would end up pointing beyond the end of the array. By pointing at an undefined memory location, a program runs the risk of causing a runtime error.

## 6.5 Conditional Structures

We will assume that all values are unsigned in this section.

1. Code example:

```

    cmp ebx,ecx
    jna next
    mov X,1
next:

```

2. Code example:

```

    cmp edx,ecx
    jnbe L1
    mov X,1
    jmp next
L1: mov X,2
next:

```

3. Future changes to the table will alter the value of NumberOfEntries. We might forget to update the constant manually, but the assembler can correctly adjust a calculated value.

4. Code example:

```

.data
sum DWORD 0
sample DWORD 50
array DWORD 10,60,20,33,72,89,45,65,72,18
ArraySize = ($ - Array) / TYPE array
.code
    mov eax,0                ; sum
    mov edx,sample
    mov esi,0                ; index
    mov ecx,ArraySize
L1: cmp esi,ecx
    jnl L5
    cmp array[esi*4],edx
    jng L4
    add eax,array[esi*4]
L4: inc esi
    jmp L1
L5: mov sum,eax

```

## 6.6 Application: Finite-State Machines

1. A directed graph.
2. Each node is a state.



3. Each edge is a transition from one state to another, caused by some input.
4. State C.
5. An infinite number of digits.
6. The FSM enters an error state.
7. No. The proposed FSM would permit a signed integer to consist of only a plus (+) or minus (−) sign. The FSM in Section 6.6.2 would not permit that.

## 6.7 Conditional Control Flow Directives

No review questions.

## 7 Integer Arithmetic

### 7.1 Shift and Rotate Instructions

1. ROL
2. RCR
3. RCL
4. The Carry flag receives the lowest bit of AX (before the shift).
5. Code example:

```

        shr ax,1           ; shift AX into Carry flag
        rcr bx,1          ; shift Carry flag into BX
; Using SHRD:
        shrd bx,ax,1

```

6. Code example:

```

        mov ecx,32        ; loop counter
        mov bl,0          ; counts the '1' bits
L1:     shr eax,1          ; shift into Carry flag
        jnc L2            ; Carry flag set?
        inc bl             ; yes: add to bit count
L2:     loop L1           ; continue loop
; if BL is odd, clear the parity flag
; if BL is even, set the parity flag
        shr bl,1
        jc odd
        mov bh,0
        or bh,0           ; PF = 1
        jmp next
odd:
        mov bh,1
        or bh,1           ; PF = 0
next:

```

## 7.2 Shift and Rotate Applications

1. We can factor the expression into  $(EAX * 16) + (EAX * 8)$ .

```
mov ebx,eax           ; save a copy of eax
shl eax,4            ; multiply by 16
shl ebx,3            ; multiply by 8
add eax,ebx          ; add the products
```

2. As the hint explains, we can express this as  $(EAX * 16) + (EAX * 4) + EAX$ .

```
mov ebx,eax           ; save a copy of eax
mov ecx,eax          ; save another copy of eax
shl eax,4            ; multiply by 16
shl ebx,2            ; multiply by 4
add eax,ebx          ; add the products
add eax,ecx          ; add original value of eax
```

3. Change the instruction at label L1 to `shr eax,1`.
4. We will assume that the time stamp word is in the DX register:

```
shr dx,5
and dl,00111111b     ; (leading zeros optional)
mov bMinutes,dl      ; save in variable
```

## 7.3 Multiplication and Division Instructions

1. The product is stored in registers that are twice the size of the multiplier and multiplicand. If you multiply `0FFh` by `0FFh`, for example, the product (`FE01h`) easily fits within 16 bits.
2. When the product fits completely within the lower register of the product, `IMUL` sign-extends the product into the upper product register. `MUL`, on the other hand, zero-extends the product.
3. With `IMUL`, the Carry and Overflow flags are set when the upper half of the product is not a sign extension of the lower half of the product.
4. EAX
5. AX
6. AX
7. Code example:

```
mov ax,dividendLow
cwd                       ; sign-extend dividend
mov bx,divisor
idiv bx
```

## 7.4 Extended Addition and Subtraction

1. The `ADC` instruction adds both a source operand and the Carry flag to a destination operand.
2. The `SBB` instruction subtracts both a source operand and the Carry flag from a destination operand.

3. EAX = C0000000h, EDX = 00000010h
4. EAX = F0000000h, EDX = 000000FFh
5. DX = 0016h

## 7.5 ASCII and Unpacked Decimal Arithmetic

1. Code example:

```
or ax,3030h
```

2. Code example:

```
and ax,0F0Fh
```

3. Code example:

```
and ax,0F0Fh           ; convert to unpacked
aad
```

4. Code example:

```
aam
```

## 7.6 Packed Decimal Arithmetic

1. When the sum of a packed decimal addition is greater than 99, DAA sets the Carry flag. For example,

```
mov al,56h
add al,92h           ; AL = E8h
daa                 ; AL = 48h, CF=1
```

2. When a larger packed decimal integer is subtracted from a small one, DAS sets the Carry flag. For example,

```
mov al,56h
sub al,92h           ; AL = C4h
das                 ; AL = 64h, CF=1
```

3.  $n + 1$  bytes

## 8 Advanced Procedures

### 8.1 Introduction

No review questions.

### 8.2 Stack Frames

1. True
2. True
3. True
4. False
5. True

6. True
7. Value parameters and Reference parameters

### 8.3 Recursion

1. False
2. It terminates when  $n$  equals zero.
3. The following instructions execute after each recursive call has finished:

```
ReturnFact:
    mov ebx, [ebp+8]
    mul ebx
L2:    pop ebp
    ret 4
```

4. The calculated value would exceed the range of an unsigned doubleword, and would roll past zero. The output would appear to be smaller than 12 factorial.
5. 12! uses 156 bytes of stack space. *Rationale:* When  $n = 0$ , 12 stack bytes are used (3 stack entries, each equal to 4 bytes). When  $n = 1$ , 24 bytes are used. When  $n = 2$ , 36 bytes are used. Therefore, the amount of stack space required for  $n!$  is  $(n + 1) \times 12$ .

### 8.4 INVOKE, ADDR, PROC, and PROTO

1. True
2. False
3. False
4. True

### 8.5 Creating Multimodule Programs

1. True
2. False
3. True
4. False

### 8.6 Advanced Use of Parameters

No review questions.

### 8.7 Java Bytecodes

No review questions.

## 9 Strings and Arrays

### 9.1 Introduction

No review questions.

## 9.2 String Primitive Instructions

1. EAX
2. SCASD
3. EDI
4. LODSW
5. Repeat while ZF = 1

## 9.3 Selected String Procedures

1. False (it stops when the null terminator of the shorter string is reached)
2. True
3. False
4. False

## 9.4 Two-Dimensional Arrays

1. Any general-purpose 32-bit registers.
2. 16.
3. No. EBP should be reserved as a base pointer for the current procedure's stack frame.

## 9.5 Searching and Sorting Integer Arrays

1.  $n - 1$  times
2.  $n - 1$  times
3. No. It decreases by 1 each
4.  $T(5000) = 0.5 * 10^2$  seconds

## 9.6 Java Bytecodes: String Processing (Optional Topic)

No review questions.

## 10 Structures and Macros

### 10.1 Structures

1. `temp1 MyStruct <>`
2. `temp2 MyStruct <0>`
3. `temp3 MyStruct <, 20 DUP(0)>`
4. `array MyStruct 20 DUP(<>)`
5. `mov ax,array.field1`

6. Code example:

```
mov esi,OFFSET array
add esi,3 * (TYPE myStruct)
mov (MyStruct PTR[esi]).field1.ax
```

7. 82

8. 82

9. `TYPE MyStruct.field2` (or: `SIZEOF Mystruct.field2`)

## 10.2 Macros

1. False
2. True
3. Macros with parameters can be reused more easily.
4. False
5. True
6. False

## 10.3 Conditional-Assembly Directives

1. The IFB directive is used to check for blank macro parameters.
2. The IFIDN directive compares two text values and returns true if they are identical. It performs a case-sensitive comparison.
3. EXITM
4. IFIDNI is the case-insensitive version of IFIDN.
5. The IFDEF returns true if a symbol has already been defined.

## 10.4 Defining Repeat Blocks

1. The WHILE directive repeats a statement block based on a boolean expression.
2. The REPEAT directive repeats a statement block based on the value of a counter.
3. The FOR directive repeats a statement block by iterating over a list of symbols.
4. The FORC directive repeats a statement block by iterating over a string of characters.
5. FORC
6. Code example:

```
BYTE 0,0,0,100
BYTE 0,0,0,20
BYTE 0,0,0,30
```

7. Code example:

```
mRepeat MACRO 'X',50
mov cx,50
??0000: mov ah,2
mov dl,'X'
int 21h
```

```

    loop ??0000
mRepeat MACRO AL,20
    mov cx,20
??0001: mov ah,2
    mov dl,AL
    int 21h
    loop ??0001
mRepeat MACRO byteVal,countVal
    mov cx,countVal
??0002: mov ah,2
    mov dl,byteVal
    int 21h
    loop ??0002

```

8. If we examine the linked list data (in the listing file), it is apparent that the **NextPtr** field of each **ListNode** always equals 00000008 (the address of the second node):

| Offset   | ListNode                              |
|----------|---------------------------------------|
| 00000000 | 00000001 NodeData<br>00000008 NextPtr |
| 00000008 | 00000002 NodeData<br>00000008 NextPtr |
| 00000010 | 00000003 NodeData<br>00000008 NextPtr |
| 00000018 | 00000004 NodeData<br>00000008 NextPtr |
| 00000020 | 00000005 NodeData<br>00000008 NextPtr |
| 00000028 | 00000006 NodeData<br>00000008 NextPtr |

We hinted at this in the text when we said “the location counter’s value (\$) remains fixed at the first node of the list.”

## 11 MS-Windows Programming

### 11.1 Win32 Console Programming

1. /SUBSYSTEM:CONSOLE
2. True
3. False
4. False
5. True

### 11.2 Writing a Graphical Windows Application

*Note:* Most of these questions can be answered by looking in *GraphWin.inc*, the include file supplied with this book’s sample programs.

1. A `POINT` structure contains two fields, `ptX` and `ptY`, that describe the X- and Y-coordinates (in pixels) of a point on the screen.
2. The `WNDCLASS` structure defines a window class. Each window in a program must belong to a class, and each program must define a window class for its main window. This class is registered with the operating system before the main window can be shown.
3. `lpfnWndProc` is a pointer to a function in an application program that receives and processes event messages triggered by the user.
4. The `style` field is a combination of different style options, such as `WS_CAPTION` and `WS_BORDER`, that control a window's appearance and behavior.
5. `hInstance` holds a handle to the current program instance. Each program running under MS-Windows is automatically assigned a handle by the operating system when the program is loaded into memory.

### 11.3 Dynamic Memory Allocation

1. Dynamic memory allocation
2. Returns a 32-bit integer handle to the program's existing heap area in `EAX`.
3. Allocates a block of memory from a heap.
4. HeapCreate example:

```

HEAP_START = 2000000      ; 2 MB
HEAP_MAX   = 400000000   ; 400 MB
.data
hHeap HANDLE ?          ; handle to heap
.code
INVOKE HeapCreate, 0, HEAP_START, HEAP_MAX

```

5. Pass a pointer to the memory block (along with the heap handle).

### 11.4 x86 Memory Management

1. (a) Multitasking permits multiple programs (or tasks) to run at the same time. The processor divides up its time between all of the running programs.  
(b) Segmentation provides a way to isolate memory segments from each other. This permits multiple programs to run simultaneously without interfering with each other.
2. (a) A segment selector is a 16-bit value stored in a segment register (`CS`, `DS`, `SS`, `ES`, `FS`, or `GS`).  
(b) A logical address is a combination of a segment selector and a 32-bit offset.
3. True
4. True
5. False
6. False



## 12 Floating-Point Processing and Instruction Encoding

### 12.1 Floating-Point Binary Representation

1. Because the reciprocal of  $-127$  is  $+127$ , which would generate an overflow.
2. Because adding  $+128$  to the exponent bias ( $127$ ) would generate a negative value.
3. 52 bits
4. 8 bits

### 12.2 Floating-Point Unit

1. fld st(0)
2. R0
3. Choose from opcode, control, status, tag word, last instruction pointer, last data pointer.
4. Binary-coded decimal
5. None

### 12.3 x86 Instruction Encoding

1. (a) 8E (b) 8B (c) 8A (d) 8A (e) A2 (f) A3
2. (a) D8 (b) D3 (c) 1D (d) 44 (e) 84 (f) 85

## 13 High-Level Language Interface

### 13.1 Introduction

1. The naming convention used by a language refers to the rules or characteristics regarding the naming of variables and procedures.
2. Tiny, small, compact, medium, large, huge
3. No, because the procedure name will not be found by the linker.

### 13.2 Inline Assembly Code

1. Inline assembly code is assembly language source code that is inserted directly into high-level language programs. The inline qualifier in C++, on the other hand, asks the C++ compiler to insert the body of a function directly into the program's compiled code to avoid the extra execution time it would take to call and return from the function. (Note: Answering this question requires some knowledge of the C++ language that is not covered in this book.)
2. The primary advantage to writing inline code is simplicity because there are no external linking issues, naming problems, and parameter passing protocols to worry about. Secondly, inline code can execute more quickly because it avoids the extra execution time typically required by calling and returning from an assembly language procedure.

3. Examples of comments (select any two):

```
mov esi,buf           ; initialize index register
mov esi,buf           // initialize index register
mov esi,buf           /* initialize index register */
```

4. Yes

### 13.3 Linking 32-Bit Assembly Language Code to C/C++

1. The `extern` and “C” keywords must be used.
2. The Irvine32 library uses `STDCALL`, which is not the same as the C calling convention used by C and C++. The important difference is in how the stack is cleaned up after a function call.
3. Floating-point values are usually pushed on the processor’s floating-point stack before returning from the function.
4. A short int is returned in the AX register.

# D

---

# BIOS AND MS-DOS INTERRUPTS

- D.1 Introduction
- D.2 PC Interrupts
- D.3 Interrupt 21H Functions (MS-DOS Services)
- D.4 Interrupt 10H Functions (Video BIOS)
- D.5 Keyboard BIOS INT 16h Functions
- D.6 Mouse Functions (INT 33h)

## D.1 Introduction

This appendix lists some of the more commonly used interrupt numbers, in groups:

- General list of PC interrupts, which correspond to the Interrupt vector table stored in the first 1024 bytes of memory.
- INT 21h MS-DOS functions
- INT 10h Video BIOS functions
- INT 16h Keyboard BIOS functions
- INT 33h Mouse functions

Documenting PC interrupts is a huge task, due to the many different versions of MS-DOS, as well as various DOS extenders and PC hardware controllers. The definitive source for interrupts is Ralf Brown's Interrupt List, available in various forms on the web. My personal favorite is the HTML version, of which one version is currently available at <http://www.ctyme.com/rbrown.htm>. Web URLs change often, so check our book's web site for up-to-date links to the Ralf Brown Interrupt List and other assembly language web sites.

## D.2 PC Interrupts

Table D-1 General List of PC Interrupt Numbers.<sup>a</sup>

| Number | Description                                                                                                                                                     |
|--------|-----------------------------------------------------------------------------------------------------------------------------------------------------------------|
| 0      | <i>Divide Error.</i> CPU-generated: activated when attempting to divide by zero.                                                                                |
| 1      | <i>Single Step.</i> CPU-generated: active when the CPU Trap flag is set.                                                                                        |
| 2      | <i>Nonmaskable Interrupt.</i> External hardware: activated when a memory error occurs.                                                                          |
| 3      | <i>Breakpoint.</i> CPU-generated: activated when the 0CCh (INT 3) instruction is executed.                                                                      |
| 4      | <i>INTO Detected Overflow.</i> CPU-generated: Activated when the INTO instruction is executed and the Overflow flag is set.                                     |
| 5      | <i>Print Screen.</i> Activated either by the INT 5 instruction or pressing the Shift-PrtSc keys.                                                                |
| 6      | <i>Invalid OpCode (80286+)</i>                                                                                                                                  |
| 7      | <i>Processor Extension Not Available (80286+)</i>                                                                                                               |
| 8      | <i>IRQ0: System Timer Interrupt.</i> Updates the BIOS clock 18.2 times per second. For your own programming, see INT 1Ch.                                       |
| 9      | <i>IRQ1: Keyboard Hardware Interrupt.</i> Activated when a key is pressed. Reads the key from the keyboard port and stores it in the keyboard typeahead buffer. |
| 0A     | <i>IRQ2: Programmable Interrupt Controller</i>                                                                                                                  |
| 0B     | <i>IRQ3: Serial Communications (COM2)</i>                                                                                                                       |
| 0C     | <i>IRQ4: Serial Communications (COM1)</i>                                                                                                                       |
| 0D     | <i>IRQ5: Fixed Disk</i>                                                                                                                                         |
| 0E     | <i>IRQ6: Diskette Interrupt.</i> Activated when a disk seek is in progress.                                                                                     |
| 0F     | <i>IRQ7: Parallel Printer</i>                                                                                                                                   |
| 10     | <i>Video Services.</i> Routines for manipulating the video display (see the complete list in Table D-3).                                                        |
| 11     | <i>Equipment Check.</i> Return a word showing all the peripherals attached to the system.                                                                       |
| 12     | <i>Memory Size.</i> Return the amount of memory (in 1024-byte blocks) in AX.                                                                                    |
| 13     | <i>Floppy Disk Services.</i> Reset the disk controller, get the status of the most recent disk access, read and write physical sectors, and format a disk.      |
| 14     | <i>Asynchronous (Serial) Port Services.</i> Initialize and read or write the asynchronous communications port, and return the port's status.                    |
| 15     | Cassette Controller.                                                                                                                                            |
| 16     | <i>Keyboard Services.</i> Read and inspect keyboard input (see the complete list in Table D-4).                                                                 |
| 17     | <i>Printer Services.</i> Initialize, print, and return the status of the printer.                                                                               |
| 18     | <i>ROM BASIC.</i> Execute cassette BASIC in ROM.                                                                                                                |

Table D-1 (Continued)

| Number | Description                                                                                                                                              |
|--------|----------------------------------------------------------------------------------------------------------------------------------------------------------|
| 19     | <i>Bootstrap Loader.</i> Reboot MS-DOS.                                                                                                                  |
| 1A     | <i>Time of Day.</i> Get the number of timer ticks since the machine was turned on, or set the counter to a new value. Ticks occur 18.2 times per second. |
| 1B     | <i>Keyboard Break.</i> This interrupt handler is executed by INT 9h when CTRL-BREAK is pressed.                                                          |
| 1C     | <i>User Timer Interrupt.</i> Empty routine, executed 18.2 times per second. May be used by your own program.                                             |
| 1D     | <i>Video Parameters.</i> Point to a table containing initialization and information for the video controller chip.                                       |
| 1E     | <i>Diskette Parameters.</i> Point to a table containing initialization information for the diskette controller.                                          |
| 1F     | <i>Graphics Table.</i> 8 × 8 Graphics font. Table kept in memory of all extended graphics characters with ASCII codes higher than 127.                   |
| 20     | <i>Terminate Program.</i> Terminate a COM program (INT 21h Function 4Ch should be used instead).                                                         |
| 21     | <i>MS-DOS Services</i> (see the complete list in Table D-2).                                                                                             |
| 22     | <i>MS-DOS Terminate Address.</i> Point to the address of the parent program or process. When the current program ends, this will be the return address.  |
| 23     | <i>MS-DOS Break Address.</i> MS-DOS jumps here when CTRL-BREAK is pressed.                                                                               |
| 24     | <i>MS-DOS Critical Error Address.</i> DOS jumps to this address when there is a critical error in the current program, such as a disk media error.       |
| 25     | <i>Absolute Disk Read</i> (obsolete).                                                                                                                    |
| 26     | <i>Absolute Disk Write</i> (obsolete).                                                                                                                   |
| 27     | <i>Terminate and Stay Resident</i> (obsolete).                                                                                                           |
| 28–FF  | (Reserved)                                                                                                                                               |
| 33     | <i>Microsoft Mouse.</i> Functions that track and control the mouse.                                                                                      |
| 34–3E  | <i>Floating-Point Emulation.</i>                                                                                                                         |
| 3F     | <i>Overlay manager.</i>                                                                                                                                  |
| 40–41  | <i>Fixed Disk Services.</i> Fixed disk controller.                                                                                                       |
| 42–5F  | Reserved: specialized uses                                                                                                                               |
| 60–6B  | Available for application programs to use.                                                                                                               |
| 6C–7F  | Reserved: specialized uses                                                                                                                               |
| 80–F0  | Reserved: used by ROM BASIC.                                                                                                                             |
| F1–FF  | Available for application programs.                                                                                                                      |

<sup>a</sup>Sources: Ray Duncan, *Advanced MS-DOS*, 2nd ed., Microsoft Press, 1998; *Ralf Brown's Interrupt List*, available on the web.

### D.3 Interrupt 21H Functions (MS-DOS Services)

There are so many MS-DOS services available through INT 21h that we could not possibly document them all here. Instead, Table D-2 is simply a brief overview of functions that are commonly used.

Table D-2 Interrupt 21h Functions (MS-DOS Services).

| Function | Description                                                                                                                                                                                                  |
|----------|--------------------------------------------------------------------------------------------------------------------------------------------------------------------------------------------------------------|
| 1        | <i>Read character from standard input.</i> If no character is ready, wait for input. Returns: AL = character.                                                                                                |
| 2        | <i>Write character to standard output.</i> Receives: DL = character.                                                                                                                                         |
| 3        | <i>Read character from standard auxiliary input</i> (serial port).                                                                                                                                           |
| 4        | <i>Write character to standard auxiliary output</i> (serial port).                                                                                                                                           |
| 5        | <i>Write character to printer.</i> Receives: DL = character.                                                                                                                                                 |
| 6        | <i>Direct console input/output.</i> If DL = FFh, read a waiting character from standard input. If DL is any other value, write the character in DL to standard output.                                       |
| 7        | <i>Direct character input without echo.</i> Wait for a character from standard input. Returns: AL = character.                                                                                               |
| 8        | <i>Character input without echo.</i> Wait for a character from the standard input device. Returns: AL = character. Character not echoed. May be terminated by Ctrl-Break.                                    |
| 9        | <i>Write string to standard output.</i> Receives: DS:DX = address of string.                                                                                                                                 |
| 0A       | <i>Buffered keyboard input.</i> Read a string of characters from the standard input device. Receives: DS:DX points to a predefined keyboard structure.                                                       |
| 0B       | <i>Check standard input status.</i> Check to see if an input character is waiting. Returns: AL = 0FFh if the character is ready; otherwise, AL = 0.                                                          |
| 0C       | <i>Clear keyboard buffer and invoke input function.</i> Clear the console input buffer, and then execute an input function. Receives: AL = desired function (1, 6, 7, 8, or 0Ah).                            |
| 0E       | <i>Select default drive.</i> Receives: DL = drive number (0 = A, 1 = B, etc.).                                                                                                                               |
| 0F–18    | FCB file functions (obsolete).                                                                                                                                                                               |
| 19       | <i>Get current default drive.</i> Returns: AL = drive number (0 = A, 1 = B, etc.)                                                                                                                            |
| 1A       | <i>Set disk transfer address.</i> Receives: DS:DX contains address of disk transfer area.                                                                                                                    |
| 25       | <i>Set interrupt vector.</i> Set an entry in the Interrupt Vector Table to a new address. Receives: DS:DX points to the interrupt-handling routine that is inserted in the table; AL = the interrupt number. |
| 26       | <i>Create new program segment prefix.</i> Receives: DX = segment address for new PSP.                                                                                                                        |
| 27–29    | FCB file functions (obsolete).                                                                                                                                                                               |
| 2A       | <i>Get system date.</i> Returns: AL = Day of the week (0–6, where Sunday = 0), CX = year, DH = month, and DL = day.                                                                                          |
| 2B       | <i>Set system date.</i> Receives: CX = year, DH = month, and DL = day. Returns: AL = 0 if the date is valid.                                                                                                 |
| 2C       | <i>Get system time.</i> Returns: CH = hour, CL = minutes, DH = seconds, and DL = hundredths of seconds.                                                                                                      |
| 2D       | <i>Set system time.</i> Receives: CH = hour, CL = minutes, DH = seconds, and DL = hundredths of seconds. Returns: AL = 0 if the time is valid.                                                               |
| 2E       | <i>Set Verify flag.</i> Receives: AL = new state of MS-DOS Verify flag (0 = off, 1 = on), and DL = 00h.                                                                                                      |

Table D-2 (Continued)

| Function | Description                                                                                                                                                                                                                                                                                       |
|----------|---------------------------------------------------------------------------------------------------------------------------------------------------------------------------------------------------------------------------------------------------------------------------------------------------|
| 2F       | <i>Get disk transfer address (DTA).</i> Returns: ES:BX = address.                                                                                                                                                                                                                                 |
| 30       | <i>Get MS-DOS version number.</i> Returns: AL = major version number, AH = minor version number, BH = OEM serial number, and BL:CX = 24-bit user serial number.                                                                                                                                   |
| 31       | <i>Terminate and stay resident.</i> Terminate the current program or process, leaving part of itself in memory. Receives: AL = return code, and DX = requested number of paragraphs.                                                                                                              |
| 32       | <i>Get MS-DOS drive parameter block.</i> Receives: DL = drive number. Returns: AL = status; DS:BX points to drive parameter block.                                                                                                                                                                |
| 33       | <i>Extended break checking.</i> Indicates whether or not MS-DOS is checking for Ctrl-Break.                                                                                                                                                                                                       |
| 34       | <i>Get address of INDOS flag.</i> (Undocumented)                                                                                                                                                                                                                                                  |
| 35       | <i>Get interrupt vector.</i> Receives: AL = interrupt number. Returns: ES:BX = segment/offset of the interrupt handler.                                                                                                                                                                           |
| 36       | <i>Get disk free space.</i> (FAT16 only) Receives: DL = drive number (0 = default, 1 = A, etc.). Returns: AX = sectors per cluster, or FFFFh if the drive number is invalid; BX = number of available clusters, CX = bytes per sector, and DX = clusters per drive.                               |
| 37       | <i>Get switch character.</i> (Undocumented)                                                                                                                                                                                                                                                       |
| 38       | <i>Get or set country information.</i> <sup>a</sup>                                                                                                                                                                                                                                               |
| 39       | <i>Create subdirectory.</i> Receives: DS:DX points to an ASCIIZ string with the path and directory name. Returns: AX = error code if the Carry flag is set.                                                                                                                                       |
| 3A       | <i>Remove subdirectory.</i> Receives: DS:DX points to an ASCIIZ string with the path and directory name. Returns: AX = error code if the Carry flag is set.                                                                                                                                       |
| 3B       | <i>Change current directory.</i> Receives: DS:DX points to an ASCIIZ string with the new directory path. Returns: AX = error code if the Carry flag is set.                                                                                                                                       |
| 3C       | <i>Create or truncate file.</i> Create a new file or truncate an old file to zero bytes. Open the file for output. Receives: DS:DX points to an ASCIIZ string with the file name, and CX = file attribute. Returns: AX = error code if the Carry flag is set; otherwise AX = the new file handle. |
| 3D       | <i>Open existing file.</i> Open a file for input, output, or input-output. Receives: DS:DX points to an ASCIIZ string with the filename, and AL = the access code (0 = read, 1 = write, 2 = read/write). Returns: AX = error code if the Carry flag is set, otherwise AX = the new file handle.   |
| 3E       | <i>Close file handle.</i> Close the file or device specified by a file handle. Receives: BX = file handle from previous open or create. Returns: If the Carry Flag is set, and AX = error code.                                                                                                   |
| 3F       | <i>Read from file or device.</i> Read a specified number of bytes from a file or device. Receives: BX = file handle, DS:DX points to an input buffer, and CX = number of bytes to read. Returns: If the Carry flag is set, AX = error code; otherwise, AX = number of bytes read.                 |
| 40       | <i>Write to file or device.</i> Write a specified number of bytes to a file or device. Receives: BX = file handle, DS:DX points to an output buffer, and CX = the number of bytes to write. Returns: If the Carry flag is set, AX = error code; otherwise, AX = number of bytes written.          |
| 41       | <i>Delete file.</i> Remove a file from a specified directory. Receives: DS:DX points to an ASCIIZ string with the filename. Returns: AX = error code if the Carry flag is set.                                                                                                                    |

Table D-2 (Continued)

| Function | Description                                                                                                                                                                                                                                                                                                                                                                                                                                   |
|----------|-----------------------------------------------------------------------------------------------------------------------------------------------------------------------------------------------------------------------------------------------------------------------------------------------------------------------------------------------------------------------------------------------------------------------------------------------|
| 42       | <i>Move file pointer.</i> Move the file read/write pointer according to a specified method. Receives: CX:DX = distance (bytes) to move the file pointer, AL = method code, and BX = file handle. The method codes are as follows: 0 = move from beginning of file, 1 = move to the current location plus an offset, and 2 = move to the end of file plus an offset. Returns: AX = error code if the Carry flag is set.                        |
| 43       | <i>Get/Set file attribute.</i> Get or set the attribute of a file. Receives: DS:DX = pointer to an ASCIIZ path and filename, CX = attribute, and AL = function code (1 = set attribute, 0 = get attribute). Returns: AX = error code if the Carry flag is set.                                                                                                                                                                                |
| 44       | <i>I/O control for devices.</i> Get or set device information associated with an open device handle, or send a control string to the device handle, or receive a control string from the device handle.                                                                                                                                                                                                                                       |
| 45       | <i>Duplicate file handle.</i> Return a new file handle for a file that is currently open. Receives: BX = file handle. Returns: AX = error code if the Carry flag is set.                                                                                                                                                                                                                                                                      |
| 46       | <i>Force duplicate file handle.</i> Force the handle in CX to refer to the same file at the same position as the handle in BX. Receives: BX = existing file handle and CX = second file handle. Returns: AX = error code if the Carry flag is set.                                                                                                                                                                                            |
| 47       | <i>Get current directory.</i> Get the full path name of the current directory. Receives: DS:SI points to a 64-byte area to hold the directory path, and DL = drive number. Returns: A buffer at DS:SI is filled with the path, and AX = error code if the Carry flag is set.                                                                                                                                                                  |
| 48       | <i>Allocate memory.</i> Allocate a requested number of paragraphs of memory, measured in 16-byte blocks. Receives: BX = number of paragraphs requested. Returns: AX = segment of the allocated block and BX = size of the largest block available (in paragraphs), and AX = error code if the Carry flag is set.                                                                                                                              |
| 49       | <i>Free allocated memory.</i> Free memory that was previously allocated by Function 48h. Receives: ES = segment of the block to be freed. Returns: AX = error code if the Carry flag is set.                                                                                                                                                                                                                                                  |
| 4A       | <i>Modify memory blocks.</i> Modify allocated memory blocks to contain a new block size. The block will shrink or grow. Receives: ES = segment of the block and BX = requested number of paragraphs. Returns: AX = error code if the Carry flag is set and BX = maximum number of available blocks.                                                                                                                                           |
| 4B       | <i>Load or execute program.</i> Create a program segment prefix for another program, load it into memory, and execute it. Receives: DS:DX points to an ASCIIZ string with the drive, path, and filename of the program; ES:BX points to a parameter block and AL = function value. Function values in AL: 0 = load and execute the program; 3 = load but do not execute (overlay program). Returns: AX = error code if the Carry flag is set. |
| 4C       | <i>Terminate process.</i> Usual way to terminate a program and return to either MS-DOS or a calling program. Receives: AL = 8-bit return code, which can be queried by DOS function 4Dh or by the ERRORLEVEL command in a batch file.                                                                                                                                                                                                         |
| 4D       | <i>Get return code of process.</i> Get the return code of a process or program, generated by either function call 31h or function call 4Ch. Returns: AL = 8-bit code returned by the program, AH = type of exit generated: 0 = normal termination, 1 = terminated by CTRLBREAK, 2 = terminated by a critical device error, and 3 = terminated by a call to function call 31h.                                                                 |
| 4E       | <i>Find first matching file.</i> Find the first filename that matches a given file specification. Receives: DS:DX points to an ASCIIZ drive, path, and file specification; CX = file attribute to be used when searching. Returns: AX = error code if the Carry flag is set; otherwise, the current DTA is filled with the filename, attribute, time, date, and size. DOS function call 1Ah (set DTA) is usually called before this function. |



Table D-2 (Continued)

| Function | Description                                                                                                                                                                                                                                                                                                                                                                                       |
|----------|---------------------------------------------------------------------------------------------------------------------------------------------------------------------------------------------------------------------------------------------------------------------------------------------------------------------------------------------------------------------------------------------------|
| 4F       | <i>Find next matching file.</i> Find the next filename that matches a given file specification. This is always called after DOS function 4Eh. Returns: AX = error code if the Carry flag is set; otherwise, the current DTA is filled with the file's information.                                                                                                                                |
| 54       | <i>Get Verify flag.</i> Returns: AH = Verify flag for disk I/O (0 = off; 1 = on).                                                                                                                                                                                                                                                                                                                 |
| 56       | <i>Rename/move file.</i> Rename a file or move it to another directory. Receives: DS:DX points to an ASCIIZ string that specifies the current drive, path, and filename; ES:DI points to the new path and filename. Returns: AX = error code if the Carry flag is set.                                                                                                                            |
| 57       | <i>Get/Set file date/time.</i> Get or set the date and time stamp for a file. Receives: AL = 0 to get the date/time or AL = 1 to set the date/time; BX = file handle, CX = new file time, and DX = new file date. Returns: AX = error code if the Carry flag is set; otherwise, CX = current file time and DX = current file date.                                                                |
| 58       | <i>Get or set memory allocation strategy.</i> <sup>a</sup>                                                                                                                                                                                                                                                                                                                                        |
| 59       | <i>Get extended error information.</i> Return additional information about an MS-DOS error, including the error class, locus, and recommended action. Receives: BX = MS-DOS version number (zero for version 3.xx). Returns: AX = extended error code, BH = error class, BL = suggested action, and CH = locus.                                                                                   |
| 5A       | <i>Create temporary file.</i> Generate a unique filename in a specified directory. Receives: DS:DX points to an ASCIIZ pathname, ending with a backslash (\); CX = desired file attribute. Returns: AX = error code if the Carry flag is set; otherwise, DS:DX points to the path with the new filename appended.                                                                                 |
| 5B       | <i>Create new file.</i> Try to create a new file, but fail if the filename already exists. This prevents you from overwriting an existing file. Receives: DS:DX points to an ASCIIZ string with the path and filename. Returns: AX = error code if the Carry flag is set.                                                                                                                         |
| 5C–61    | Omitted.                                                                                                                                                                                                                                                                                                                                                                                          |
| 62       | <i>Get program segment prefix (PSP) address.</i> Returns: BX = the segment value of the current program's PSP.                                                                                                                                                                                                                                                                                    |
| 7303h    | <i>Get disk free space.</i> Fills a structure containing detailed disk space information. Receives: AX = 17303h, ES:DI points to a ExtGetDskFreSpcStruc structure, CX = size of the ExtGetDskFreSpcStruc structure, and DS:DX points to a null-terminated string containing the drive name. Returns: The ExtGetDskFreSpcStruc is filled in with disk information. See Section 15.5.1 for details. |
| 7305h    | <i>Absolute disk read and write.</i> Reads individual disk sectors or groups of sectors. Does not work under Windows NT, 2000, and XP. Receives: AX = 7305h, DS:BX = segment/offset of a DISKIO structure variable, CX = 0FFFFh, DL = drive number (0 = default, 1 = A, 2 = B, 3 = C, etc.), and SI = Read/write flag. See Section 15.4 for details.                                              |

<sup>a</sup>For details see Ray Duncan, *Advanced MS-DOS*, 2nd ed., Microsoft Press, 1998; *Ralf Brown's Interrupt List*, available on the web.

## D.4 Interrupt 10H Functions (Video BIOS)

Table D-3 Interrupt 10h Functions (Video BIOS).

| Function | Description                                                                                                                                                                                                                                                                                                                                               |
|----------|-----------------------------------------------------------------------------------------------------------------------------------------------------------------------------------------------------------------------------------------------------------------------------------------------------------------------------------------------------------|
| 0        | <i>Set video mode.</i> Set the video display to monochrome, text, graphics, or color mode. Receives: AL = display mode.                                                                                                                                                                                                                                   |
| 1        | <i>Set cursor lines.</i> Identify the starting and ending scan lines for the cursor. Receives: CH = cursor starting line, and CL = cursor ending line.                                                                                                                                                                                                    |
| 2        | <i>Set cursor position.</i> Position the cursor on the screen. Receives: BH = video page, DH = row, and DL = column.                                                                                                                                                                                                                                      |
| 3        | <i>Get cursor position.</i> Get the cursor's screen position and its size. Receives: BH = video page. Returns: CH = cursor starting line, CL = cursor ending line, DH = cursor row, and DL = cursor column.                                                                                                                                               |
| 4        | <i>Read light pen.</i> Read the position and status of the light pen. Returns: CH = pixel row, BX = pixel column, DH = character row, and DL = character column.                                                                                                                                                                                          |
| 5        | <i>Set display page.</i> Select the video page to be displayed. Receives: AL = desired page number.                                                                                                                                                                                                                                                       |
| 6        | <i>Scroll window up.</i> Scroll a window on the current video page upward, replacing scrolled lines with blanks. Receives: AL = number of lines to scroll, BH = attribute for scrolled lines, CX = upper left corner row and column, and DX = lower right row and column.                                                                                 |
| 7        | <i>Scroll window down.</i> Scroll a window on the current video page downward, replacing scrolled lines with blanks. Receives: AL = number of lines to scroll, BH = attribute for scrolled lines, CX = upper left corner row and column, and DX = lower right row and column.                                                                             |
| 8        | <i>Read character and attribute.</i> Read the character and its attribute at the current cursor position. Receives: BH = display page. Returns: AH = attribute byte and AL = ASCII character code.                                                                                                                                                        |
| 9        | <i>Write character and attribute.</i> Write a character and its attribute at the current cursor position. Receives: AL = ASCII character, BH = video page, and CX = repetition factor.                                                                                                                                                                    |
| 0A       | <i>Write character.</i> Write a character only (no attribute) at the current cursor position. Receives: AL = ASCII character, BH = video page, BL = attribute, and CX = replication factor.                                                                                                                                                               |
| 0B       | <i>Set color palette.</i> Select a group of available colors for the color or EGA adapter. Receives: AL = display mode and BH = active display page.                                                                                                                                                                                                      |
| 0C       | <i>Write graphics pixel.</i> Write a graphics pixel when in color graphics mode. Receives: AL = pixel value, CX = X-coordinate, and DX = Y-coordinate.                                                                                                                                                                                                    |
| 0D       | <i>Read graphics pixel.</i> Read the color of a single graphics pixel at a given location. Receives: CX = X-coordinate, and DX = Y-coordinate.                                                                                                                                                                                                            |
| 0E       | <i>Write character.</i> Write a character to the screen and advance the cursor. Receives: AL = ASCII character code, BH = video page, BL = attribute or color.                                                                                                                                                                                            |
| 0F       | <i>Get current video mode.</i> Get the current video mode. Returns: AL = video mode and BH = active video page.                                                                                                                                                                                                                                           |
| 10       | <i>Set video palette.</i> (EGA only) Set the video palette register, border color, or blink/intensity bit. Receives: AL = function code (00 = set palette register, 01 = set border color, 02 = set palette and border color, 03 = set/reset blink/intensity bit), BH = color, and BL = palette register to set. If AL = 2, ES:DX points to a color list. |
| 11       | <i>Character generator.</i> Select the character size for the EGA display. For example, an 8 by 8 font is used for the 43-line display, and an 8 by 14 font is used for the 25-line display.                                                                                                                                                              |
| 12       | <i>Alternate select function.</i> Return technical information about the EGA display.                                                                                                                                                                                                                                                                     |
| 13       | <i>Write string.</i> (PC/AT only) Write a string of text to the video display. Receives: AL = mode, BH = page, BL = attribute, CX = length of string, DH = row, DL = column, and ES:BP points to the string (will not work on the IBM-PC or PC/XT).                                                                                                       |

## D.5 Keyboard BIOS INT 16h Functions

Table D-4 Keyboard BIOS Interrupt 16h Functions.

| Function | Description                                                                                                                                                                                                                                                                                                                                                                                                                    |
|----------|--------------------------------------------------------------------------------------------------------------------------------------------------------------------------------------------------------------------------------------------------------------------------------------------------------------------------------------------------------------------------------------------------------------------------------|
| 03h      | <i>Set typematic repeat rate.</i> Receives: AH = 03h, AL = 5, BH = repeat delay, and BL = repeat rate. The delay values in BH are 0 = 250 ms; 1 = 500 ms; 2 = 750 ms; and 3 = 1000 ms. The repeat rate in BL varies from 0 (fastest) to 1Fh (slowest). Returns: nothing.                                                                                                                                                       |
| 05h      | <i>Push key into buffer.</i> Pushes a keyboard character and corresponding scan code into the keyboard typeahead buffer. Receives: AH = 05h, CH = scan code, and CL = character code. If the typeahead buffer is already full, the Carry flag will be set, and AL = 1. Returns: nothing                                                                                                                                        |
| 10       | <i>Wait for key.</i> Wait for an input character and keyboard scan code. Receives: AH = 10h. Returns: AH = scan code, and AL = ASCII character. (Function 00h duplicates this function, using an older type of keyboard.)                                                                                                                                                                                                      |
| 11       | <i>Check keyboard buffer.</i> Find out if a character is waiting in the keyboard typeahead buffer. Receives: AH = 01h. Returns: If a key is waiting, its scan code is returned in AH and its ASCII code is returned in AL, and the Zero flag is cleared (the character will remain in the input buffer). If no key is waiting, the Zero flag is set. (Function 01h duplicates this function, using an older type of keyboard.) |
| 12       | <i>Get keyboard flags.</i> Return the Keyboard Flag byte stored in low RAM. Receives: AH = 12h. Returns: Keyboard flags in AX. (Function 02h duplicates this function, using an older type of keyboard.)                                                                                                                                                                                                                       |

## D.6 Mouse Functions (INT 33h)

INT 33h mouse functions receive their function number in the AX register. For more information about these functions, see Section 16.6. For additional mouse functions, see Table 16-9.

Table D-5 INT 33h Mouse Functions.

| Function | Description                                                                                                                                                                                                                                                                                                                                                        |
|----------|--------------------------------------------------------------------------------------------------------------------------------------------------------------------------------------------------------------------------------------------------------------------------------------------------------------------------------------------------------------------|
| 0000h    | <i>Reset mouse and get status.</i> Receives: AX = 0000h. Resets the mouse and confirms that it is available. The mouse (if found) is centered on the screen, its display page is set to video page 0, its pointer is hidden, and its mickeys-to-pixels ratios and speed are set to default values. The mouse's range of movement is set to the entire screen area. |
| 0001h    | <i>Show mouse pointer.</i> Receives: AX = 0001h. Returns: nothing. The mouse driver keeps a count of the number of times this function is called.                                                                                                                                                                                                                  |
| 0002h    | <i>Hide mouse pointer.</i> Receives: AX = 0002h. Returns: nothing. The mouse position is still tracked when it is invisible.                                                                                                                                                                                                                                       |
| 0003h    | <i>Get mouse position and status.</i> Receives: AX = 0003h. Returns: BX = mouse button status, CX = X-coordinate (in pixels), and DX = Y-coordinate (in pixels).                                                                                                                                                                                                   |
| 0004h    | <i>Set mouse position.</i> Receives: AX = 0004h, CX = X-coordinate (in pixels), and DX = Y-coordinate (in pixels). Returns: nothing.                                                                                                                                                                                                                               |
| 0005h    | <i>Get button press information.</i> Receives: AX = 0005h, and BX = button ID (0 = left, 1 = right, 2 = center). Returns: AX = button status, BX = button press counter, CX = X-coordinate of last button press, and DX = Y-coordinate of last button press.                                                                                                       |
| 0006h    | <i>Get button release information.</i> Receives: AX = 0006h, and BX = button ID (0 = left, 1 = right, 2 = center). Returns: AX = button status, BX = button release counter, CX = X-coordinate of last button release, and DX = Y-coordinate of last button release.                                                                                               |
| 0007h    | <i>Set horizontal limits.</i> Receives: AX = 0007h, CX = minimum X-coordinate (in pixels), and DX = maximum X-coordinate (in pixels). Returns: nothing.                                                                                                                                                                                                            |
| 0008h    | <i>Set vertical limits.</i> Receives: AX = 0008h, CX = minimum Y-coordinate (in pixels), and DX = maximum Y-coordinate (in pixels). Returns: nothing.                                                                                                                                                                                                              |

---

# ANSWERS TO REVIEW QUESTIONS (CHAPTERS 14–17)

## 14 16-Bit MS-DOS Programming

### 14.1 MS-DOS and the IBM-PC

1. 9FFFFh.
2. Interrupt vector table.
3. 00400h.
4. The BIOS.
5. Suppose a program was named myProg.exe. The following would redirect its output to the default printer:  
myProg > prn
6. LPT1.
7. An interrupt service routine (also called an interrupt handler) is an operating system procedure that (1) provides basic services to application programs, and (2) handles hardware events.
8. Push the flags on the stack.
9. See the four steps in Section 14.1.4.
10. The interrupt handler executes an IRET instruction.
11. 10h.
12. 1Ah.
13.  $21h * 4 = 0084h$ .

### 14.2 MS-DOS Function Calls (INT 21h)

1. AH.
2. Function 4Ch.
3. Functions 2 and 6 both write a single character.
4. Function 9.

5. Function 40h.
6. Functions 1 and 6.
7. Function 3Fh.
8. Functions 2Ah and 2Bh. To display the time, you would call the WriteDec procedure from the book's library. That procedure uses Function 2 to output digits to the console. (Look in the Irvine16.asm file for details, located in the \Examples\Lib16 directory.)
9. Functions 2Bh (set system date) and 2Dh (set system time).
10. Function 6.

### 14.3 Standard MS-DOS File I/O Services

1. Device handles: 0 = Keyboard (standard input), 1 = Console (standard output), 2 = Error output, 3 = Auxiliary device (asynchronous), and 4 = Printer.
2. Carry flag.
3. Parameters for function 716Ch:

```

AX = 716Ch
BX = access mode (0 = read, 1 = write, 2 = read/write)
CX = attributes (0 = normal, 1 = read only, 2 = hidden,
                3 = system, 8 = volume ID, 20h = archive)
DX = action (1 = open, 2 = truncate, 10h = create)
DS:SI = segment/offset of filename
DI = alias hint (optional)

```

4. Opening an existing file for input:

```

.data
infile BYTE "myfile.txt",0
inHandle WORD ?
.code
mov ax,716Ch           ; extended create or open
mov bx,0              ; mode = read-only
mov cx,0              ; normal attribute
mov dx,1              ; action: open
mov si,OFFSET infile
int 21h               ; call MS-DOS
jc quit               ; quit if error
mov inHandle,ax

```

5. Reading a binary array from a file is best done with INT 21h Function 3Fh. The following parameters are required:
 

```

AH = 3Fh
BX = open file handle
CX = maximum bytes to read
DS:DX = address of input buffer

```
6. After calling INT 21h, compare the return value in AX to the value that was placed in CX before the function call. If AX is smaller, the end of the file must have been reached.
7. The only difference is the value in BX. When reading from the keyboard, BX is set to the keyboard handle (0). When reading from a file, BX is set to the handle of the open file.
8. Function 42h.
9. Code example (BX already contains the file handle):

```
mov ah,42h           ; move file pointer
mov al,0             ; method: offset from beginning
mov cx,0             ; offset Hi
mov dx,50            ; offset Lo
int 21h
```

## 15 Disk Fundamentals

### 15.1 Disk Storage Systems

1. True.
2. False.
3. Cylinder.
4. True.
5. 512.
6. For faster access because the closer are the cylinders, the smaller is the distance that the read/write heads must travel.
7. The read/write heads must jump over other cylinders, wasting time and increasing the probability that errors will occur.
8. Volume.
9. The average amount of time required to move the read/write heads between tracks.
10. The marking of physical sectors on the disk surfaces.
11. The master boot record contains the disk partition table and a program that locates a single partition's boot sector and runs another program that loads the operating system.
12. One partition.
13. System.

### 15.2 File Systems

1. True.
2. No. It is in the disk directory.
3. False (all systems, including NTFS, require at least one cluster to store a file).
4. False.
5. False.
6. 4 GByte (shown in Table 15-1).
7. FAT32 and NTFS.
8. NTFS.
9. NTFS.
10. NTFS.
11. NTFS.
12. 8 GByte.
13. Boot record, file allocation table, root directory, and the data area.
14. This information is at offset 0Dh in the boot record.

15. Two 8 KByte clusters would be required, for a total of 16,384 bytes. The number of wasted bytes would be  $(16,384 - 8,200)$ , or 8,184 bytes.
16. (This one is up to you!)

### 15.3 Disk Directory

1. True.
2. False (it is called the root directory).
3. False (it contains the starting *cluster* number).
4. True.
5. 32 bytes.
6. Filename, extension, attribute, time stamp, date stamp, starting cluster number, and file size.
7. The status bytes and their descriptions are listed in Table 15-5.
8. Bits 0 to 4 = seconds; bits 5 to 10 = minutes; and bits 11 to 15 = hours.
9. The first byte of the entry is 4xh, where *x* indicates the number of long filename entries to be used for the file.
10. Two filename entries.
11. There are three new fields: last access date, create date, and create time.
12. File allocation table links:

|   |   |   |   |   |   |   |     |   |    |    |    |    |    |    |    |
|---|---|---|---|---|---|---|-----|---|----|----|----|----|----|----|----|
|   | 3 | 7 | 8 |   | 4 | 6 | eof |   |    |    |    |    |    |    |    |
| 1 | 2 | 3 | 4 | 5 | 6 | 7 | 8   | 9 | 10 | 11 | 12 | 13 | 14 | 15 | 16 |

### 15.4 Reading and Writing Disk Sectors

1. True.
2. False (the function runs in real-address mode).
3. Parameters:
  - AX: 7305h
  - DS:BX: Segment/offset of a DISKIO structure variable
  - CX: 0FFFFh
  - DL: Drive number (0 = default, 1 = A, 2 = B, 3 = C, etc.)
  - SI: Read/write flag
4. INT 10h displays special ASCII graphics characters without trying to interpret them as control codes (such as Tab and Carriage return).
5. The Carry flag is set if function 7305h cannot read the requested sector, and the program displays an error message. (Remember that you cannot test this program under Windows NT, 2000, XP, and beyond.)

### 15.5 System-Level File Functions

1. Function 7303h.
2. Function 7303h.
3. Function 39h (create subdirectory) and Function 3Bh (set current directory).
4. Function 7143h (get and set file attributes).

## 16 BIOS-Level Programming

### 16.1 Introduction

No review questions.

### 16.2 Keyboard Input with INT 16h

1. INT 16h is best.
2. In the keyboard typeahead buffer, at location 0040:001E.
3. INT 9h reads the keyboard input port, retrieves the keyboard scan code, and produces the corresponding ASCII code. It inserts both in the keyboard typeahead buffer.
4. Function 05h.
5. Function 10h.
6. Function 11h examines the buffer and lets you know which key, if any, is waiting.
7. No.
8. Function 12h.
9. Bit 4.
10. Code example:

```
L1: mov ah,12h           ; get keyboard flags
    int 16h
    test al,100h        ; Ctrl key down?
    jz L1               ; no: repeat the loop
    ; At this point, the Ctrl key has been pressed
```

11. To check for other keyboard keys, add more CMP and JE instructions after the existing ones currently in the loop. Suppose we wanted to check for the ESC, F1, and Home keys:

```
L1: .
    .
    cmp ah,1           ; ESC key's scan code?
    je quit           ; yes: quit
    cmp ah,3Bh        ; F1 function key?
    je quit           ; yes: quit
    cmp ah,47h        ; Home key?
    je quit           ; yes: quit
    jmp L1            ; no: check buffer again
```

### 16.3 Video Programming with INT 10h

1. MS-DOS level, BIOS level, and Direct video level.
2. Direct video.
3. In MS-Windows, there are two ways to switch into full-screen mode:
  - Create a shortcut to the program's EXE file. Then open the Properties dialog for the shortcut, select the Screen properties, and select Full-screen mode.
  - Open a Command window from the Start menu, then press Alt-Enter to switch to full-screen mode. Using the CD (change directory) command, navigate to your EXE file's directory, and run the program by typing its name. Alt-Enter is a toggle, so if you press it again, it will return the program to Window mode.



4. Mode 3 (color,  $80 \times 25$ ).
5. ASCII code and attribute (2 bytes).
6. Red, green, blue, and intensity.
7. Background: bits 4 to 7. Foreground: bits 0 to 3.
8. Function 02h.
9. Function 06h.
10. Function 09h.
11. Function 01h.
12. Function 00h.
13. AH = 2, DH = row, DL = column, and BH = video page.
14. There are two ways: (1) use INT 10h Function 01h to set the cursor's top line to an illegal value, or (2) use INT 10h Function 02h to position the cursor outside the displayable range of rows and columns.
15. AH = 6, AL = number of lines to scroll, BH = attribute of scrolled lines, CH & CL = upper left window corner, and DH & DL = lower right window corner.
16. AH = 9, AL = ASCII code of character, BH = video page, BL = attribute, and CX = repetition count.
17. Function 10h, Subfunction 03h (set AH to 10h and AL to 03h).
18. AH = 06h, and AL = 0.

## 16.4 Drawing Graphics Using INT 10h

1. Function 0Ch.
2. AH = 0Ch, AL = pixel value, BH = video page, CX = X-coordinate, and DX = Y-coordinate.
3. It's very slow.
4. Code example:
 

```

mov ah,0           ; set video mode
mov al,11h        ; to mode 11h
int 10h           ; call the BIOS
      
```
5. Mode 6Ah.
6. Formula:  $sx = (sOrigX + X)$ .
7. a. (350,150)   b. (375,225)   c. (150,400).

## 16.5 Memory-Mapped Graphics

1. False (each byte corresponds to 1 pixel).
2. True.
3. Mode 13h maps each pixel's integer value into a table of colors called a palette.
4. The color index of a pixel identifies which color in the palette is to be used when drawing the pixel on the screen.
5. Each entry in the palette consists of three separate integer values (0 to 63) known as RGB (red, green, blue). Entry 0 in the color palette controls the screen's background color.
6. (20,20,20).

7. (63,63,63).

8. (63,0,0).

9. Code example:

```

; Set screen background color to bright green.
mov  dx,3c8h                ; video paletter port
mov  al,0                   ; index 0 (background color)
out  dx,al
mov  dx,3c9h                ; colors go to port 3C9h
mov  al,0                   ; red
out  dx,al
mov  al,63                  ; green (intensity = 63)
out  dx,al
mov  al,0                   ; blue
out  dx,al

```

10. Code example:

```

; Set screen background color to white
mov  dx,3c8h                ; video paletter port
mov  al,0                   ; index 0 (background color)
out  dx,al
mov  dx,3c9h                ; colors go to port 3C9h
mov  al,63                  ; red = 63
out  dx,al
mov  al,63                  ; green = 63
out  dx,al
mov  al,63                  ; blue = 63
out  dx,al

```

(The last two MOV statements can be eliminated if you want to reduce the amount of code in this example.)

## 16.6 Mouse Programming

1. Function 0.

2. Code example:

```

mov  ax,0                   ; reset mouse
int  33h                   ; call the BIOS
cmp  ax,0                   ; mouse not available?
je   MouseNotAvailable     ; yes: show error message

```

3. Functions 1 and 2.

4. Code example:

```

mov  ax,2                   ; hide mouse pointer
int  33h

```

5. Function 3.

6. Code example:

```

mov  ax,3                   ; get mouse position and status
int  33h
mov  mouseX,cx
mov  mouseY,dx

```

7. Function 4.

## 8. Code example:

```

mov    ax,4           ; set mouse position
mov    cx,100        ; X-value
mov    dx,400        ; Y-value
int    33h

```

## 9. Function 5.

## 10. Code example:

```

mov    ax,5           ; get button press information
mov    bx,0           ; button ID for left button
int    33h
test   ax,1           ; left button currently down?
jne    Button1        ; yes: jump to label

```

*Implementation note:* This function will tell you if a certain button is currently being pressed. But if you just want the coordinates of the last button press, there is no need for the TEST instruction used in our example.

## 11. Function 6.

## 12. Code example:

```

mov    ax,6           ; get button release information
mov    bx,1           ; button ID
int    33h
test   ax,2           ; right button released?
jz     skip           ; no - skip
mov    mouseX,cx      ; yes: save coordinates
mov    mouseY,dx

```

skip:

## 13. Code example:

```

mov    ax,8           ; set vertical limits
mov    cx,200        ; lower limit
mov    dx,400        ; upper limit
int    33h

```

## 14. Code example:

```

mov    ax,7           ; set horizontal limits
mov    cx,300        ; lower limit
mov    dx,600        ; upper limit
int    33h

```

15. Assuming that character cells are 8 pixels by 8 pixels, the X, Y-coordinates values would be (8 \* 20), (8 \* 10). The cell will be at position 160, 80.

16. The upper left corner of the cell will be at (8 \* 22), (8 \* 15). If we add 4 to each of these values to bring the mouse to the center of the cell, the answer is 180, 124.

17. The mouse was invented by Douglas Engelbart in 1963 at the Stanford Research Institute. (Source: [http://en.wikipedia.org/wiki/Computer\\_mouse](http://en.wikipedia.org/wiki/Computer_mouse)).

## 17 Expert MS-DOS Programming

### 17.1 Introduction

No review questions.

## 17.2 Defining Segments

1. SEGMENT declares the beginning of a segment, and ENDS declares the end of a segment.
2. Returns the segment address of a data label or code label.
3. The ASSUME directive makes it possible for the assembler to calculate the offsets of labels and variables at assembly time. A directive such as  

```
assume DS:myData
```

says to the assembler, “assume that from this point on, all references to data labels (via DS) will be located in the segment named **myData**.”
4. BYTE, WORD, DWORD, PARA, and PAGE.
5. PRIVATE, PUBLIC, MEMORY, STACK, COMMON, and AT.
6. DWORD.
7. The combine type tells the linker how to combine segments having the same name.
8. Use the AT combine type. The following defines a segment with value 0040h:  

```
bios SEGMENT AT 40h
```
9. A segment’s class type provides another way of combining segments, in particular, those with different names. Segments having the same class type are loaded together, although they may be listed in a different order in the program source code.
10. Code example:  

```
mov al,es:[di]
```
11. The third segment will also begin at address 1A060h.

## 17.3 Runtime Program Structure

1. The command processor checks to see if there is filename with extension COM in the current directory. If a file is found, it is executed. If a matching file is not found, see Section 17.3 for a description of the subsequent steps.
2. No.
3. Application programs loaded into the lowest 640K of memory. They are transient because when they finish executing, they are automatically unloaded from memory.
4. Program segment prefix.
5. At offset 2Ch inside the program segment prefix area.
6. A COM program is a single-segment MS-DOS program. When stored on disk as a COM file, it is simply a binary image of the program when loaded into memory.
7. Tiny.
8. /T.
9. 64 KByte.
10. Not efficient because even the smallest COM program uses an entire 64K memory segment.
11. One.
12. All segment registers are set to offset zero within the program. The program, in turn, is loaded into memory at the first available segment location following other programs still in memory.
13. The ORG directive assigns a specific offset to the very next label or instruction following the directive. The addresses of all subsequent labels are calculated from that point onward. COM

programs, for example, always have ORG 100h at the beginning of the program code, so the first executable instruction will be located at offset 100h.

14. Load module.
15. DS and ES point to the program segment prefix area of the program.
16. MS-DOS automatically allocates all of available memory to a program when it is first loaded, unless the program's EXE header specifically limits its maximum memory allocation size.
17. The EXEMOD program displays statistics about a program's memory usage, and also permits many settings in the EXE header to be modified.
18. Run the EXEMOD program, passing it the name of the EXE file. The last line of the display will show the number of relocation entries.

## 17.4 Interrupt Handling

1. It displays a message on the screen "Abort, retry, or ignore?" and terminates the current program.
2. A 32-bit segment/offset address pointing to an interrupt handler.
3. At address 0000:0040h because 0040h equals 10h \* 4.
4. The 8259 Programmable Interrupt Controller chip.
5. The CLI (clear interrupt flag) instruction.
6. The STI (set interrupt flag) instruction.
7. IRQ 0 has highest priority.
8. Before the file has been created because the keyboard (IRQ 1) is at a higher priority than the disk drive (IRQ 14).
9. INT 9h.
10. An IRET instruction at the end of the interrupt handler returns control to the code that was running when the interrupt occurred.
11. Functions 25h and 35h.
12. An interrupt handler is any procedure that takes over processing an interrupt. It might be loaded when an application starts and then be unloaded when the application ends. A memory-resident program, on the other hand, remains in memory even after the program that installed it has ended. A memory-resident program does not necessarily have to be an interrupt handler.
13. A terminate and stay resident (TSR) program leaves part of itself in the memory when it exits. This is accomplished by calling INT 21h function 31h.
14. The computer can be rebooted, or a special utility program can remove the TSR.
15. Rather than executing an IRET instruction when it finishes, it can instead execute a JMP to the address that was previously stored in the interrupt vector.
16. A terminate and stay resident (TSR) program.
17. Ctrl + Alt + Right shift + Del.

# INDEX

---

- A**
- 
- `__asm` Directive (Visual C++), 564–566
- AAA (ASCII adjust after addition) instruction, 274, 280
- AAD (ASCII adjust before division) instruction, 276, 280
- AAM (ASCII adjust after multiplication) instruction, 276, 280
- AAS (ASCII adjust after subtraction) instruction, 276, 280
- ADC (add with carry) instruction, 269–270, 280
- ADD instruction, 105–106, 109, 112
- AddTwo* program, 63–64
- adding a variable, 75–76
  - listing file for, 71–73
  - running and debugging, 65–70
  - 64-bit programming, 88–90
- Addition and subtraction, 105–112
- ADD instruction, 105–106
  - arithmetic expressions, implementing, 106–107
  - example program (AddSub Test), 111
  - flags affected by, 107–110
  - INC and DEC instruction, 105
  - NEG instruction, 106
  - SUB instruction, 106
- Addition test, 110
- Address bus, 34
- Address space, 38
- ADDR operator, 312
- AddTwo procedure, 293, 314, 336
- Advanced Micro Devices (AMD) Athlon, 33
- Advanced procedures, 286–347
- recursion, 302–311
  - stack frames, 287–302
- ALIGN directive, 113–114
- AllocConsole function, 450
- American National Standards Institute (ANSI), 19
- American Standard Code for Information Interchange. *See* ASCII
- AND instruction, 191–192
- AND (boolean operator), 22–23
- Application Programming Interface (API), 47, 179, 445
- Arithmetic expressions, implementing, 106–107, 267–268
- Arithmetic instructions, 526–530
- Arithmetic logic unit (ALU), 33
- Arithmetic operators, 56
- Arithmetic shifts versus logical shifts, 243–244
- ArrayFill procedure, 297
- ArraySum, 150–151
- procedure, 151–152, 317, 319, 556
  - program, 315
- Arrays
- calculating the sizes, 85–86
  - indirect operands, 117–118
  - looping through, 395
- The Art of Computer Programming* (Knuth), 2
- ASCII, 19
- control characters, 20, 14–9
  - decimal and unpacked decimal, 274
  - string, 20
  - unpacked decimal arithmetic and, 273–277
- askForInteger function, 574

- 
- Assemble-link-execute cycle, 71
  - Assemblers, 2, 71
  - Assembly code, 215–216
    - generating, 215
    - versus compiler
      - optimization, 565
      - versus nonoptimized C++ code, 569
  - Assembly language, 1–9, 26, 33, 49, 53–94
    - access levels, 49
    - applications of, 5–6
    - definition, 2
    - elements of, 54–63
    - high-level languages and, 6
    - to optimize C++ code, 565
    - reasons for learning, 5
    - relationship between machine and, 4
  - Assembly language module, 574–575
  - Auxiliary carry flag (AC), 41, 107, 283
- 
- B**
- 
- Base address, 503
  - Base-index-displacement operands, 371–372
  - Base-index operands, 369–371
    - calculating a Row Sum, 370–371
    - scale factors, 371
    - two-dimensional array, 372
  - Base-offset addressing, 291
  - Basic Input-Output System (BIOS), 44, 47, 16.2
  - Binary addition, 12
  - Binary bits, displaying, 168
  - Binary file, creating, 14.30–14.33
  - Binary floating-point numbers, normalized, 514
  - Binary integer, 9
    - signed, 10
    - translating unsigned binary integers to decimal, 11
    - translating unsigned decimal integers to binary, 11–12
    - unsigned, 10
  - Binary multiplication, 253
  - Binary subtraction, 18–19
  - Binary reals, converting decimal fraction to, 516–518
  - Binary search
    - algorithm, 375–376
    - test program for, 378–382
  - BIOS (Basic Input-Output System), 44, 47, 16.2
  - Bit-mapped sets, 194–195
  - Bit masking, 192
  - Bit strings, 254
  - Bitwise instructions, 232
  - Block comments, 62
  - Block-structured IF statements, 210–213
  - Boolean algebra, 22
  - Boolean and comparison instructions, 190–199
    - AND instruction, 191–192
    - bit-mapped sets, 194–195
    - CMP instruction, 197–198
    - CPU flags, 191
    - NOT instruction, 196
    - OR instruction, 192–193
      - setting and clearing individual CPU flags, 198–199
      - in 64-bit mode, 199
    - TEST instruction, 196–197
    - XOR instruction, 195–196
  - Boolean expression, 22–26, 423
  - Boolean operations, 22–26
    - boolean expression, 22–24
    - boolean operations, truth tables for, 24–26
    - operator precedence, 24
  - Branching instructions, 341
    - .BREAK condition, 225
  - Brink, James, 322, 533
  - Bubble sort, 373–375
    - assembly language, 375
    - pseudocode, 374–375
    - test program, 378–382
  - BubbleSort procedure, 300
  - Bus, 45
  - BYTE, 76–78
  - Byte, 77
- 
- C**
- 
- C++, 5
    - assembly language and, 4
    - module, 567–568
    - startup program, 567, 581
    - stub module, 582
  - Cache memory, 36
  - CalcSum procedure, 303

- Calling convention, 556
- CALL instruction, 147–148, 153–154, 174, 177
- C and C++ compilers, 559
- C and C++ functions, calling, 574
  - assembly language module, 574–575
  - function prototypes, 574
  - function return values, 575
- Carry flag, 40, 106
  - addition and, 107–108
  - subtraction and, 108
- CBW (convert byte to word) instruction, 264
- C language calling convention, 577
- CDQ (convert doubleword to quadword) instruction, 265, 280
- Central Processor Unit (CPU), in microcomputer, 34
- Character constant, 57–58
- Character set, 19
- Character storage, 19–21
- Chipset, motherboard, 45–46
- C language specifier, 559
- C library functions, calling, 579–581
- Clock, 33–34
- Clock cycle, 34
- Close file handle (3Eh), 14.23
- CloseFile procedure, 158
- CloseHandle function, 466
- Clrscr procedure, 159, 171
- CMOS RAM, 44, 46, 50
- CMP instruction, 197–198
- CMPSB instruction, 355
- CMPSD instruction, 355
- CMPSW instruction, 355
- .CODE directive, 59, 65
- Code examples
  - array dot product, 536
  - expression, 535–536
  - sum of an array, 536
  - sum of square roots, 536
- Code label, 60
- Code segment, 55, 72
- Command processor, 14.2–14.3
- Command tail, MS-DOS, 14.27–14.30
- Comments, 62
- Comparison instructions, 341
- Compiler-generated code, 559–563
- Complex Instruction Set Computer (CISC) design, 539
- Compound expressions, 213–216, 228–231
- Conditional and loop instructions, 209–210
  - LOOPE (loop if equal) instruction, 209
  - LOOPNE (loop if not equal) instruction, 209
  - LOOPNZ (loop if not zero) instruction, 209
  - LOOPZ (loop if zero) instruction, 209
- Conditional-assembly directives, 420–433
  - boolean expressions, 423
  - default argument initializers, 422–423
  - IF, ELSE, and ENDIF directives, 423–424
  - IFIDN and IFIDNI directive, 424–425
- macro functions, 431–433
  - missing arguments, checking for, 421–422
  - special operators, 428–431
- Conditional branching, 190
- Conditional control flow directives, 225–232
  - compound expressions, 228–231
  - IF statements, creating, 226–227
  - .REPEAT and .WHILE directives, 231–232
  - signed and unsigned comparisons, 227–228
- Conditional jump, 199–208
  - applications, 204–208
  - conditional structures, 199–200
  - Jcond* instruction, 200–201
  - types of, 201–204
- Conditional structures, 210–219
  - block-structured IF statements, 210–213
  - compound expressions, 213–214
  - definition, 210
  - WHILE loops, 214–216
- Conditional transfer, 123
- Condition codes (floating point), 530–531
- Console input, 455–461
  - console input buffer, 455–459
  - getting keyboard state, 460–461
  - single-character input, 459–460



- Console output, 461–463
    - data structures, 461–462
    - WriteConsole function, 462–463
    - WriteConsoleOutput
      - Character function, 463
  - Console Window, 157, 473
  - .CONTINUE directive, 225
  - Control bus, 33–34, 36
  - Control flags, 40
  - Control unit (CU), 33
  - COORD structure, 391, 438, 461
  - Copying a string, 127–128
  - CPU flags, 104, 201, 14.33
    - display in Visual Studio
      - Debugger, 104
  - CreateConsoleScreenBuffer function, 450
  - CreateFile function, 463
  - CreateFile parameters, 464
  - CreateFile program example, 470–471
  - Create or open file (716Ch), 14.22–14.23
  - CreateOutputFile procedure, 159
  - Crlf procedure, 159
  - CR/LF (carriage-return line-feed), 78
  - Current location counter, 85
  - CWD (convert word to doubleword) instruction, 264
- 
- D**
- 
- DAA (decimal adjust after addition) instruction, 277–278
  - DAS (decimal adjust after subtraction) instruction, 279
  - Data bus, 33–35
  - Data definition statement, 74–75
    - BYTE and SBYTE data, 74
    - data types in, 74–75
    - defining strings, 77–78
    - DUP operator DWORD and SDWORD data, 78–79
    - initializer, 75
    - little endian order, 82–83
    - multiple initializers, 77
    - packed binary coded decimal (BCD), 80
    - real number data, 81
    - WORD and SWORD data, 74–75
  - .DATA directive, 59, 83
  - Data label, 60
  - Data-related operators and directives, 112–117
    - align directive, 113–114
    - offset operator, 112–113
  - Data representation, 9–21
    - binary addition, 12
    - binary integers, 11–12
    - character storage, 19–21
    - hexadecimal integers, 13–15
    - integer storage sizes, 13
    - signed integers, 16–19
  - Data segment, 55, 77, 83, 90
  - Data transfer, 96–132
    - direct memory operands, 96–97
    - direct-offset operands, 102–103
    - example program, 103–104
    - LAHF and SAHF instructions, 101
    - MOV instruction, 98–99
    - operand types, 96
    - XCHG instruction, 102
    - zero/sign extension of integers, 99–101
  - Debugger, 15, 54
  - Debugging tips
    - argument size mismatch, 321
    - passing immediate values, 321–322
    - passing wrong type of pointer, 321
  - Decimal real, 57
  - Declaring and using unions, 403–405
    - declaring and using union variables, 404–405
    - structure containing union, 404
  - Default argument initializers, 422
  - Delay procedure, 159
  - Descriptor table, 37, 40, 502
  - Destination operand, 61, 98
  - Device drivers, 5, 47–48
  - Direct addressing, 117
    - Directed graph, 219
  - Direction flags, 40, 69, 354
  - Directives, 59
  - Direct memory operands, 96–97
  - Direct-offset operands, 102–103
  - Directory listing program
    - ASM module, 582–583
    - C++ stub module, 582
  - DisplaySum procedure, 328, 332
  - Display\_Sum procedure, 271
  - DIV instruction, 262–264

- Doubleword (4bytes), 13, 593, 601  
 DRAM. *See* Dynamic random-access memory (DRAM)  
 “Drunkard’s Walk” exercise, 399  
 DumpMem procedure, 159, 171, 178, 349, 413  
 DumpRegs procedure, 160, 178  
 DUP operator, 78–79, 85, 91  
 DWORD, 74, 79  
 Dynamic link library, 154  
 Dynamic memory allocation, 492–499  
 Dynamic random-access memory (DRAM), 46
- 
- E**
- EBP register, 290  
 ECHO directive, 409  
 EFLAGS register, 40, 44  
 .ELSE directive, 225, 423  
 .ELSEIF condition, 225, 226  
 Embedded programs, 5  
 Encoded reals, 55, 57  
 END directive marks, 65  
 .ENDIF directive, 225, 226, 233, 423  
 ENDP directive marks, 65  
 .ENDW directive, 225  
 ENTER instruction, 298–300  
 EPROM. *See* Erasable programmable read-only memory (EPROM)  
 Equal-sign directive, 84–85  
 EQU directive, 86–87  
 Erasable programmable read-only memory (EPROM), 46
- ErrorHandler procedure, 488  
 Exception synchronization, 534–535  
 Executable file, 71  
 EXITM (exit macro) directive, 421  
 ExitProcess function, 64  
 Expansion operator (%), 429–430  
 Explicit stack parameters, 291  
 Extended addition and subtraction, 269–273  
   ADC instruction, 269–270  
   extended addition example, 270–272  
   SBB instruction, 272  
 Extended addition example, 270–272  
 Extended\_Add procedure, 270–271  
 Extended Physical Addressing, 38  
 External identifiers, 556  
 External library, linking to, 153–155  
 EXTERNDEF directive, 325  
 EXTERN directive, 323–326
- 
- F**
- FABS (absolute value) instruction, 527  
 Factorial, calculating, 304–310  
 Factorial procedure, 305–306, 308  
 FADD (add) instruction, 526–527  
 FADDP (add with pop) instruction, 526–527  
 Fast division (SHR), 246  
 Fast multiplication (SHL), 251  
 FCHS (change sign) instruction, 526–527  
 FCOM (compare floating-point values) instruction, 530–533  
 FDIV instruction, 526, 529–530  
 FIADD (add integer) instruction, 526–527  
 Fibonacci Generator, 188  
 Field initializers, 391–392  
 FILD (load integer) instruction, 525  
 File/device handles, 14.20–14.21  
 File encryption example, 566–569  
 File I/O  
   in the Irvine32 Library, 468–470  
   testing procedures of, 470–473  
 FillArray procedure, 312, 315  
 FillConsoleOutputAttribute function, 450  
 FillConsoleOutputCharacter function, 450  
 FindArray  
   code generated by Visual C++, 537  
 Finite-state machine (FSM), 219  
 FINIT instruction, 524  
 FISUB (subtract integer) instruction, 528–529  
 Flags  
   addition and subtraction, 105–112  
   attribute values and, 463  
   setting and clearing CPU, 198–199

- Flat memory model, 64, 557–558, 564
  - Floating-point binary representation, 511–518
    - converting decimal fractions to binary reals, 516–518
    - creating IEEE representation, 514–516
    - IEEE binary floating-point representation, 512–513
    - normalized binary floating-point numbers, 514
    - single-precision exponents, 485–486
  - Floating-point data type, 524
  - Floating-point decimal number, 511
  - Floating-point exceptions, 523
  - Floating-point instruction set, 523–526
  - Floating-point unit (FPU), 39, 40, 48, 518–539
    - arithmetic instructions, 526–530
    - code examples, 535–536
    - comparing floating-point values, 530–533
    - exception synchronization, 534–535
    - floating-point exceptions, 523
    - instruction set, 523–526
    - masking and unmasking exceptions, 538–539
    - mixed-mode arithmetic, 537–538
    - reading and writing floating-point values, 533–534
    - register stack, 519–521
    - rounding, 521–522
  - Flowcharts, 233
  - FlushConsoleInputBuffer function, 450
  - FMUL instruction, 526, 529
  - FMULP (multiply with pop) instruction, 529
  - FORC directive, 435–436
  - FOR directive, 434–435
  - FPU stack, 519–521
  - FreeConsole function, 450
  - FST (store floating-point value) instruction, 526
  - FSTP (store floating-point value and pop) instruction, 526
  - FSUB instruction, 528–529
  - FSUBP (subtract with pop) instruction, 528–529
  - Function prototypes, 574
  - Function return values, 575
- 
- G
- 
- General protection (GP) fault, 322
  - General-purpose registers, 38–39
  - GenerateConsoleCtrlEvent, 451
  - GetCommandTail procedure, 156, 160, 14.28
  - GetConsoleCP function, 451
  - GetConsoleCursorInfo function, 451, 476–477
  - GetConsoleMode function, 451
  - GetConsoleOutputCP function, 451
  - GetConsoleScreenBufferInfo function, 451, 474
  - GetConsoleTitle function, 451
  - GetConsoleWindow function, 451
  - GetDateTime procedure, 481–482
  - Get file creation date and time, 14.24
  - GetKeyState function, 460
  - GetLargestConsoleWindowSize function, 451
  - GetLastError API function, 457
  - GetLocalTime function, 479–480
  - GetMaxXY procedure, 160
  - GetMseconds procedure, 161, 175, 260
  - GetNumberOfConsoleInputEvents function, 451
  - GetNumberOfConsoleMouseButtons function, 451
  - GetProcessHeap, 493–494
  - GetStdHandle function, 397, 450–451
  - GetTickCount function, 479–481
  - Gigabyte, 13
  - Global descriptor table (GDT), 502, 504, 506
  - GNU assembler, 2
  - Gotoxy procedure, 161, 349, 15.19, 16.23
  - Granularity flag, 503
  - Graphical windows application, 484–492
    - ErrorHandler procedure, 488

- Graphical windows application (continued)
- MessageBox function, 486
  - program listing, 488–492
  - WinMain procedure, 486–487
  - WinProc procedure, 487
- 
- H**
- 
- Hardware, detecting overflow, 110
- HeapAlloc, 493–494
- Heap allocation, 492, 494–495
- HeapCreate, 493–494
- HeapDestroy, 493–494
- HeapFree, 493, 495
- Heap-related functions, 493
- HeapTest programs, 496–499
- Hello World program example, 14.11–14.12
- Hexadecimal addition, 15–16
- Hexadecimal integers, 13–15
- converting unsigned hexadecimal to decimal, 14–15
  - converting unsigned decimal to hexadecimal, 15
- High-level console functions, 448
- High-level language, 4–7, 9, 47, 214
- assembly language and, 6
  - functions, 47
- High-level language interface, 555–583
- general convention, 556–557
  - inline assembly code, 564–570
  - linking to C/C++ in protected mode, 570–583
  - .MODEL directive, 557–559
- 
- I**
- 
- IA-32e mode
- compatibility mode, 43
  - 64-bit mode, 43
- IA-32 processor family (x86), 42–44
- IBM-PC and MS-DOS, 14.1–14.7
- coding for 16-bit programs, 14.6–14.7
- INT instruction, 14.5–14.6
- memory organization, 14.2–14.3
- redirecting input-output, 14.3–14.4
- software interrupts, 14.4
- IBM's PC-DOS, 14.1
- Identification number (process ID), 37
- Identifier, 58–59
- IDIV instruction, 265–266
- IEEE floating-point binary formats, 512
- IEEE representation, 514–516
- IEEE single-precision (SP), 518
- .IF condition, 225, 226
- IF directive, 227–228, 423, 432
- IFIDN directive, 424, 433
- IFIDNI directive, 424
- IF statements
- creating, 226–227
  - loop containing, 216
  - nested in loop, 214–215
- IMUL instruction, 257–263
- bit string and, 254
  - examples, 259–260
  - one-operand formats, 257–258
  - three-operand formats, 258
  - two-operand formats, 258
  - unsigned multiplication, 259
- INC and DEC instruction, 105
- INC instruction, 61
- INCLUDE directive, 325, 330, 406
- Indexed operands, 119–121, 395
- displacements, adding, 120
  - scale factors in, 120–121
  - 16-bit registers in, 120
- IndexOf module, 570–573
- Indirect addressing, 117–122
- arrays, 118–119
  - indexed operands, 119–121
  - indirect operands, 117–118
  - pointers, 121–122
- Indirect operands, 117–118, 120, 297–298, 346, 395
- Infix expression, 519
- Inline assembly code, 564–569
- \_\_asm directive in Microsoft Visual C++, 564–566

- file encryption example, 566–569
- Inline expansion, 406
- Input functions, MS-DOS, 14.12–14.16
- Input-output parameter, 320–321
- Input-output system, 47–49
- Input parameter, 366
- Input string, validating, 219–220
- Instruction, 60–62
  - comments, 62
  - instruction mnemonic, 61
  - label, 60
  - operands, 61–62, 546
- Instruction execution cycle, 34–36
- Instruction mnemonic, 61
- Instruction operand notation, 97
- Instruction pointer (EIP), 39
- Instruction set architecture (ISA), 8
  - INT (call to interrupt procedure) instruction, 14.5–14.6
  - common interrupts, 14.6
  - interrupt vectoring, 14.5
- INT 1Ah time of day, 14.6
- INT 1Ch user timer interrupt, 14.6
- INT 10h video services, 14.6
- INT 16h keyboard services, 14.6
- INT 17h printer services, 14.6
- INT 21h function 0Ah, 14.13
- INT 21h function 0Bh, 14.14
- INT 21h function 1, 14.12
- INT 21h function 2, 14.9
- INT 21h function 2Ah, 14.16–14.17
- INT 21h function 2Bh, 14.16, 14.17
- INT 21h function 2Ch, 14.16, 14.17
- INT 21h function 2Dh, 14.16, 14.18
- INT 21h function 3Eh, 14.23
- INT 21h function 3Fh, 14.15–14.16, 14.25
- INT 21h function 4Ch, 14.6, 14.8
- INT 21h function 5, 14.9–14.10
- INT 21h function 6, 14.9, –14.10, 14.12–14.14
- INT 21h function 9, 14.9, 14.10
- INT 21h function 40h, 14.9, 14.11, 14.26
- INT 21h function 42h, 14.23–14.24
- INT 21h function 5706h, 14.24
- INT 21h function 716Ch, 14.22
- INT 21h MS-DOS function calls, 14.7–14.20
- INT 21h MS-DOS services, 14.6, 14.34
- Integer arithmetic, 242–279
  - ASCII and unpacked decimal arithmetic, 273–277
  - extended addition and subtraction, 269–272
  - multiplication and division instructions, 255–268
  - packed decimal arithmetic, 277–279
  - shift and rotate applications, 251–255
  - shift and rotate instructions, 243–251
- Integer arrays, searching and sorting, 373–382
  - binary search, 375–378
  - bubble sort, 372–375
  - test program, 378–382
- Integer arrays, summing, 126–127
- Integer constant, 55
- Integer expressions, 56–57
- Integer literals, 55–57
- Integers, adding and subtracting, 63–70
- Integer storage sizes, 13
- Integer summation program, 329, 333
- Intel64, 50
  - execution environment, 43–44
  - operations mode, 43
- Intel486, 41, 518
- Intel 8086 processor, 518, 539
- Intel 8088 processor, 14.1
- Intel 80286 processor, 610
- Intel microprocessors, 14.2
- Intel P965 Express chipset, 45–47
- Intel Pentium, 33, 564
- Intel Pentium Core Duo, 33, 176, 572
- Intel processor families, 2, 41, 43
- Interrupt flags, 40
- Interrupt handler, 14.4–14.5
- Interrupts
  - BIOS 16h functions, D.9
  - mouse functions, D.9
  - PC, D.2–D.3
  - 10h functions, D.8
  - 21h functions, D.4–D.7

- Interrupt service routines (ISRs), 14.6. *See also* Interrupt handler
- Interrupt vectoring, 14.5
- Interrupt vector table, 14.2
- Intrinsic data types, 74
- INVOKE directive, 72, 89–90, 311–312, 599
- I/O access, levels of, 47–49
- BIOS, 47
  - high-level language functions, 47
  - operating system, 47
- Irvine16.lib, 14.7
- Irvine32.lib, 153–154, 456
- Irvine32 Library, 155
- overview, 157–158
  - procedures in, 156–157
  - test programs, 170–177
- Irvine64 library, 153, 178–180, 294
- string-handling procedures, 365–368
- IsDefined macro, 432
- IsDigit procedure, 162, 221, 223–224
- 
- J**
- 
- Java, 3–6, 8
- assembly language and, 4
  - virtual machine concept and, 8
- Java bytecodes, 339–340
- instruction set 340–341
- Java disassembly examples, 341–345
- Java virtual machine (JVM), 339–340
- string processing and, 382–383
- Java Development Kit (JDK), 340
- Java disassembly examples, 341–345
- adding two doubles, 343–344
  - adding two integers, 341–343
  - conditional branch, 344–345
- Java HashSet, 194
- Java primitive data types, 340–341
- Java virtual machine (JVM), 8, 339–340
- Jcond* (conditional jump) instruction, 200–201
- conditional jump applications, 204–208
  - equality comparisons, 201–202
  - signed comparisons, 202–204
  - unsigned comparisons, 202
- JMP instruction, 123–124
- 
- K**
- 
- Keyboard definition, 85
- Kilobyte, 13
- Knuth, Donald, 2
- 
- L**
- 
- Label, 60
- code, 60
  - data, 60
  - directive, 116–117
- LAHF (load status flags into AH) instruction, 101
- LEA instruction, 298
- Least significant bit (LSB), 10, 245
- LEAVE instruction, 298–300
- LENGTHOF operator, 116, 138
- Library procedures, MS-DOS, 14.24–14.25
- Library test program, 170–177
- performance timing, 175–177
  - random integers, 174–175
- LIFO (Last-In, First-Out) structure, 144
- Linear addresses, translating logical addresses to, 500–503
- Linked list, 510
- Linker command options, 154
- Linkers, 3
- Linking 32-bit programs, 154
- Link library, procedures in, 154
- .LIST, 598
- Listing file, 71–73
- ListSize, 85–86
- Literal-text operator (<>), 430–431
- Literal-character operator (!), 431
- Little-endian order, 91, 252
- Load and execute process, 36–37
- Loader, 71
- Load floating-point value (FLD), 524–525
- Local descriptor table (LDT), 502
- LOCAL directive, 300–301, 409–410
- Local variables, 295–296

- 
- LODSB instruction, 353, 356–357
  - LODSD instruction, 353, 356–357
  - LODSW instruction, 353, 356–357
  - Logical AND operator, 213
  - Logical OR operator, 214
  - Logical shifts versus arithmetic shifts, 243–244
  - Loop instruction, 123–128
  - LOOPE (loop if equal) instruction, 209, 624
  - LOOPNE (loop if not equal) instruction, 209–210, 624
  - LOOPNZ (loop if not zero) instruction, 209–210, 624
  - LOOPZ (loop if zero) instruction, 209, 624
- 
- M**
- 
- Machine language, relationship between assembly and, 4, 8
  - Macros
    - additional features of, 408–412
    - code and data in, 410–411
    - comments in macros, 409
    - debugging program that contains, 408
    - declaring, 406
    - defining, 406–407
    - functions, 431–433
    - invoking, 407–408
    - in library, 412–419
    - nested, 411–412
    - parameters, 407
    - macro procedure, 405–406
    - Wrappers example program, 419–420
  - Macros.inc library
    - mDump, 414
    - mDumpMem, 412–414
    - mGotoxy, 414–415
    - mReadString, 415–416
    - mShow, 416–417
    - mShowRegister, 417
    - mWriteSpace, 418
    - mWriteString, 418–419
    - makeString macro, 409–410
  - Masking and unmasking exceptions, 538–539
  - MASM
    - code generation, 301
  - Matrix row, summing, 425–428
    - mDump macro, 414
    - mDumpMem macro, 412–414
  - Megabyte, 13
  - Memory, 46
    - CMOS RAM, 46
    - DRAM, 46
    - dynamic allocation, 506
    - EPROM, 46
    - management, 499–505
    - models, 557
    - operands, 96–97
    - physical, 501–502
    - reading from, 36
    - ROM, 46
    - segmented model, 499
    - storage unit, 33
    - SRAM, 46
    - virtual, 501–502
    - VRAM, 46
  - Memory-mode instructions, 544–547
  - Merge procedure, 301
  - Message box display in Win32 application, 452–455
    - contents and behavior, 452–453
    - demonstration program, 453–454
    - program listing, 454–455
  - MessageBox function, 486
  - mGotoxyConst macro, 423, 429
  - mGotoxy macro, 414–415
  - Microcode, 5
  - Microcomputer, 33–34
  - Microsoft Macro Assembler (MASM), 2–3, 54–55
  - Microsoft x64 calling convention, 287, 301–302
  - Mixed-mode arithmetic, 537–538
  - MMX registers, 41
  - Mnemonic, 61
  - .MODEL directive, 64, 558–559, 575, 582
    - C language specifier, 559
    - language specifiers, 558
    - STDCALL, 558–559
  - Most significant bit (MSB), 10, 107, 245
  - Motherboard, 44–46
    - chipset, 45–46
  - MOV instruction, 98–99, 128–129
    - opcodes, 544–546
  - Move file pointer function, 14.23–14.24
  - MOVSB instruction, 353–355
  - MOVSD instruction, 353–355
  - MOVSW instruction, 353–355

- MOVSB (move with sign-extend) instruction, 100–101, 625
  - MOVZX (move with zero-extend) instruction, 99–100, 625
  - mPuchar macro, 406
  - mReadBuf macro, 424
  - mReadString macro, 415–416
  - MS-DOS
    - device names, 14.4
    - extended error codes, 14.21
    - file date fields, 254–255
    - function calls (INT 21h), 14.7–14.20
    - IBM-PC and, 14.1–14.7
    - memory map, 14.3
  - MS-DOS file I/O services, 14.20–14.33
    - close file handle (3Eh), 14.23
    - creating binary file, 14.30–14.33
    - create or open file (716Ch), 14.22–14.23
    - get file creation date and time, 14.24
    - move file pointer (42h), 14.23–14.24
    - read and copy a text file, 14.25–14.27
    - reading MS-DOS command tail, 14.27–14.30
    - selected library procedures, 14.24–14.25
  - MsgBoxAsk procedure, 156, 162–163
  - MsgBox procedure, 156, 162
  - mShow macro, 416–417
  - mShowRegister macro, 417, 428
  - MS-Windows virtual machine manager, 504
  - MUL (unsigned multiply) instruction, 253, 255–257
    - bit shifting and, 261–262
    - examples, 256–257
    - operands, 256
  - Mul32 macro, 430
  - Multimodule programs, 323
    - ArraySum program, 326
    - calling external procedures, 324–325
    - creating modules using INVOKE and PROTO, 330–333
    - creating modules using EXTERN directive, 326–330
    - hiding and exporting procedure names, 323–324
    - module boundaries, variables and symbols in, 325–326
  - Multiple shifts
    - in SHL instruction, 245
    - in SHR instruction, 245
  - Multiplexer, 26
  - Multiplication and division instructions in integer arithmetic, 255–268
    - arithmetic expressions, implementing, 267–268
    - DIV instruction, 262–264
    - IMUL instruction, 257–260
    - MUL instruction, 255–257
    - signed integer division, 264–267
  - Multiplication table example, 576
    - assembly language module, 576–577
    - C++ startup program, 577–578
    - visual studio project properties, 578–579
  - Multitasking, 499–500, 502
  - mWrite macro, 411–412
  - mWriteLn macro, 411–412, 422
  - mWriteSpace macro, 412, 418
  - mWriteString macro, 406, 412, 418–419
- 
- N**
- 
- Name decorations in C++ programs, 557, 570
  - Naming conventions, 556–557
  - NaNs (floating point), 516
  - Negative infinity, 516
  - NEG instruction, 106, 109–110
  - Nested loops, 125
  - Nested macros, 411–412
  - Nested procedure call, 148–149
  - Netwide Assembler* (NASM), 2
  - Non-doubleword local variables, 337–339
  - NOP (No Operation) instruction, 62
  - Normalized finite numbers, 515
  - NOT (boolean operator), 22
  - NOT instruction, 194, 196



Null-terminated string, 19, 77,  
160, 168–169, 178,  
357, 359, 452, 486,  
14.24–14.25, 15.23–15.24  
Numeric data representation,  
terminology for, 20–21

---

## O

---

Object file, 71  
OFFSET operator, 112–113,  
121, 129, 395, 399, 402,  
565  
One's complement, 196  
OpenInputFile procedure,  
156, 158, 163  
Operands, 60–62  
  direct memory, 96–97  
  direct-offset, 102–103  
  floating-point instruction  
  set, 523–526  
  instruction, 61–62, 97  
  types, 61, 90, 96  
Operating system (OS), 32,  
36–38, 42, 44, 47–49  
Operator precedence, 24  
Opteron processor, 33, 43  
OPTION PROC:PRIVATE  
  directive, 323–324  
OR (boolean operator),  
22–24  
OR instruction, 192–193  
OS. *See* Operating system (OS)  
Output functions, MS-DOS,  
14.9–14.11  
  filing control characters,  
  14.9–14.11(filtering)  
Output parameter, 319  
Overflow flag, 40, 69, 107,  
109–110, 164, 166, 191,  
193, 198, 249, 256, 258–  
260, 267

---

## P

---

Packed binary coded decimal  
(BCD), 80  
Packed decimal arithmetic,  
277–279  
  DAA instructions,  
  277–278  
  DAS instruction, 279  
Page fault, 501  
Paging, 446, 501  
Page translation, 500–501,  
503–504  
Parallel port, 45  
Parameter classifications,  
319–320  
Parity flag, 41, 69, 105–107,  
109, 132, 160, 191–193,  
195–197, 226, 531  
ParseDecimal32 procedure,  
156, 163  
ParseInteger32 procedure,  
156, 164  
Passing arrays, 290  
Passing by reference, 290  
Passing by value, 289  
Passing register arguments,  
150  
PCI (Peripheral Component  
Interconnect) bus, 45  
PC interrupts, D.2–D.3  
PeekConsoleInput function,  
451  
Pentium processor, 564, 591  
Pixels, 48, 484  
Pointers, 121–122  
POINT structure, 484–485,  
661  
POPAD instruction, 143  
POPA instruction, 143  
POPFD instruction, 142–143  
POP instruction, 142  
Pop operation, 141–142  
Positive infinity, 516, 522  
Preemptive multitasking, 504  
  printf function, 579–581  
  displaying formatted  
  reals with, 580  
PrintX macro, 406  
PROC directive, 145–147,  
152, 313–316, 330–333  
  parameter lists, 313–316  
  parameter passing  
  protocol, 316  
  RET instruction modified  
  by, 316  
  syntax of, 314  
Procedure call overhead,  
568–569  
Procedures  
  checking for missing  
  arguments, 421–422  
  defining, 145  
  calling external, 324–325  
  labels in, 146  
  linking to an external  
  library, 153–154  
  nested procedure calls,  
  148–149  
  overhead of, 568–569  
Processor operand-size  
  prefix, 543–544  
Process return code, 14.8  
Program execution times,  
  measuring, 260–262  
Programmable Interrupt  
  Controller (PIC), 45  
Programmable Interval  
  Timer/Counter, 45  
Programmable Parallel Port, 45  
Programming at multiple  
  levels, 48  
Program segment prefix  
  (PSP), 14.28

- PromptForIntegers procedure, 326–327, 331
- Protected mode, 3, 38, 40–42, 64, 74, 335, 398, 432, 493, 502, 557, 564, 584, 14.2, 15.15  
in indirect operands, 117–118
- PROTO directive, 154, 179, 316–319, 323–324, 330–333, 574  
assembly time argument checking, 317–319
- PTR operator, 96, 112, 114–115, 118
- PUSHA instruction, 143
- PUSHAD instruction, 143
- PUSHFD instruction, 142–143
- PUSH instruction, 142
- Push operations, 141
- 
- Q**
- 
- Quadword (8 bytes), 132
- Quiet NaN (floating point), 516
- QWORD data type, 74, 79–80
- 
- R**
- 
- Radix, 55–56, 77
- Ralf Brown's Interrupt List, 14.8, D.1
- Random32 procedure, 156, 164
- Randomize procedure, 156, 164, 178
- RandomRange procedure, 156, 164–165
- Range checking, 102, 229, 423
- Raster scanning, 48
- RCL (rotate carry left) instruction, 248–249
- RCR (rotate carry right) instruction, 248–249
- ReadChar procedure, 156
- ReadConsole function, 451, 455–456
- ReadConsoleInput function, 451
- ReadConsoleOutput function, 451
- ReadConsoleOutputAttribute function, 451
- ReadConsoleOutput Character function, 451
- ReadDec procedure, 156
- ReadFile function, 466–467
- ReadFile program example, 471–473
- Read\_File procedure, 315
- ReadFloat procedure, 533–534
- ReadFromFile procedure, 156, 165–166
- ReadHex procedure, 156, 166
- ReadInt procedure, 157, 166
- ReadKey procedure, 157, 166–167, 205, 459–460
- Read-only memory (ROM), 46, 14.2
- ReadSector example, 15.19
- ReadString procedure, 157, 167, 178, 415, 456, 14.24–14.25
- REAL4 data type, 74, 81
- REAL8 data type, 74, 81
- REAL10 data type, 74, 81
- Real-address mode programs, 38, 42, 124, 14.2, 14.6–14.8, 14.28, 14.34, 15.15–15.16, 15.20, 15.26, 17.2, 17.7
- Real number data, 81
- Rect (rectangle) structure, 485
- Recursion, 302–310  
factorial calculation, 304–310  
recursively calculating a sum, 303–304
- Recursive procedure, 188
- Reduced instruction set computer (RISC), 346, 539–540, 564
- References to named structure, 394–395
- References to structure variables, 394–396
- Register mode instructions, 542–543
- Register parameters, 179, 287–290
- Registers, 38–41  
comparing, 228  
saving and restoring, 152–153, 294–295
- Register stack, 519–521  
64-bit, 89–90
- Repeat blocks, defining, 433–437
- REPEAT directive, 434
- .REPEAT directive, 225, 231–232
- Repeat prefix, 353–355
- Reserved words, 58
- RET (return from procedure) instruction, 147–148, 181–182, 290, 292–294, 296, 303–304, 314, 316, 321, 331, 363, 558, 572
- Reversing a string, 144–145
- REX (register extension) prefix, 43–44
- ROL instruction, 247

- 
- ROM. *See* Read-only memory (ROM)
- ROM BIOS, 14.3, 16.2, 17.24
- ROR instruction, 247–248
- Rounding in FPU, 521–522
- Runtime relational and logical operators, 226–227
- Runtime stack, 140–142
- 
- S**
- 
- SAHF (store AH into status flags) instruction, 101
- SAL (shift arithmetic left) instruction, 246
- SAR (shift arithmetic right) instruction, 246
- SBB (subtract with borrow) instruction, 272
- SBYTE data type, 74–77
- Scale factors, 120–121, 371, 426
- scanf function, 30, 580–583
- SCASB instruction, 353, 356
- SCASD instruction, 353, 356
- SCASW instruction, 353, 356
- ScrollConsoleScreenBuffer function, 451, 473
- SDWORD data type, 74, 79, 314, 325, 392, 449
- Segment, 40, 55, 59
- Segment descriptor details, 502–503
- Segment descriptor table, 40
- Segment limit, 502–503
- Segment names, 556–557
- Segment present flag, 503
- Segment registers, 38, 40
- Selected string procedures, 357–368
- Sequential search of array, 205–206
- Serial port, 49, 14.4, 16.36, 17.14–17.15, 17.24
- Set complement, 194
- Set operations  
intersection, 194  
union, 194–195
- SetConsoleActiveScreenBuffer function, 451
- SetConsoleCP function, 451
- SetConsoleCtrlHandler function, 451
- SetConsoleCursorInfo function, 451, 477
- SetConsoleCursorPosition function, 398–399, 451, 473, 477
- SetConsoleMode function, 452
- SetConsoleOutputCP function, 452
- SetConsoleScreenBufferSize function, 452, 476
- SetConsoleTextAttribute function, 452, 477
- SetConsoleTitle function, 452, 473
- SetConsoleWindowInfo function, 452, 473–476
- SetCursorPosition procedure, 229–230
- SetFilePointer function, 467–468
- SetLocalTime function, 479–480
- SetStdHandle function, 452
- SetTextColor procedure, 157
- Shift and rotate applications, 251–255  
binary multiplication, 253  
displaying binary bits, 254  
isolating MS-DOS file data fields, 254–255
- shifting multiple  
doublewords, 252–253
- Shift and rotate instructions, 243–251
- Shifting multiple  
doublewords, 252–253
- SHL (shift left) instruction, 243–245
- SHLD (shift left double) instruction, 243, 249–251
- SHR (shift right) instruction, 243, 245–246
- SHRD (shift right double) instruction, 243, 249–251
- Signed and unsigned comparisons, 227–228
- Signed division in SAL and SAR instruction, 246
- Signed integer, 16  
comparing, 228  
converting signed binary to decimal, 17  
converting signed decimal to binary, 17  
converting signed decimal to hexadecimal, 17  
converting signed hexadecimal to decimal, 17  
maximum and minimum values, 18  
two's complement of hexadecimal value, 16  
two's complement notation, 16  
validating, 212–216
- Signed integer division, 264–267  
divide overflow, 266–267
- IDIV instruction, 265–266
- sign extension instructions, 264–265

- Signed overflow, 110, 249
- Sign flag (SF), 40, 107, 109, 191, 193, 198, 201, 206
- Significand (floating point), 512–513
  - precision, 513
- SIMD (Single-Instruction, Multiple-Data), 41
- Single-byte instructions, 541
- Single-character input, 459–460
- Single-line comments, 62
- Single-precision bit encodings, 515
- Single-precision exponents, 514
- 16-bit argument, 335–336
- 16-bit parity, 196
- 16-bit programs, coding for, 14.6–14.7
- 16-bit real-address mode programs, 3
- 64-bit operation modes, 43
  - Boolean instructions in, 199
  - using IMUL, 258–259
  - using MUL, 257
- 64-bit programming, 88–90, 128–131
  - assembly programming, 178–181
- SIZEOF operator, 112, 116
- SMALL\_RECT structure, 461–462
- SmallWin.inc (include file), 397–398, 405, 447–450, 453, 466, 581
- Software Development Kit (SDK), 154
- Software interrupts, 14.2, 14.4
- Source operand, 61–62, 98–99
- Special operators, 428–431
- Special-purpose registers, 521
- SRAM. *See* Static RAM (SRAM)
- Stack abstract data type, 140–141
- Stack applications, 142
- Stack data structure, 140
- .STACK directive, 59, 64, 326, 14.6, 14.54
- Stack frames, 287–302
- Stack parameters, 287–290
  - accessing, 290–292
- Stack operations, 140–145
  - affected by USES operator, 333–334
  - defining and using procedures, 145–153
  - passing stack arguments to procedures, 335–337
  - POP instruction, 142
  - PUSH instruction, 142
  - runtime stack, 140–142
- Stack segment, 40, 503, 17.5
- Static RAM (SRAM), 36, 46, 50
- Status flags, 40–41
- STC (set carry flag) instruction, 198, 634
- STDCALL calling convention, 293–294, 408, 590
- STDCALL language specifier, 558–559, 574
- STOSB instruction, 353, 356, 635
- STOSD instruction, 353, 356, 635
- STOSW instruction, 353, 356, 635
- Str\_compare procedure, 157, 358–359, 366
- Str\_copy procedure, 157, 357, 359–360, 366–367
- String, 19
  - calculating the size of, 85–86
  - copying a string, 127–128, 353–354
  - defining, 77–78
  - encryption, 206–208
  - reversing, 144–145
- String encryption program, 14.14–14.16
- String library demo program, 364–365
- String primitive instructions, 353–357
- StrLength procedure, 157
- Str\_length procedure, 178, 357, 359, 366–367
- Str\_trim procedure, 157, 358, 360–363
- Str\_ucase procedure, 157, 358, 363
- Structure, 390–405
  - aligning structure fields, 392
  - aligning structure variables, 394
  - containing other structures, 399
  - declaring variables, 393–394
  - defining, 391–392
  - indirect and index operands, 395–396
  - performance of aligned members, 396
  - references to members, 394–396
  - referencing, 370–372
- Structure chart, 326

*Structured Computer**Organization*

(Tanenbaum), 7

SUB instruction, 67, 106

Substitution operator, 414, 428

SumOf procedure, 146–147,  
153

SwapFlag, 300, 338

Swap procedure, 290, 312,  
315, 320–321SWORD data type, 74–75,  
78–79, 115, 314, 392

Symbolic constant, 84–88

System management mode  
(SMM), 38SYSTEMTIME structure,  
397, 440, 479–480, 482,  
505System time, displaying,  
397–399

---

**T**

---

Table-driven selection,  
216–219TBYTE data type, 74, 80,  
115–116, 314, 524, 593,  
602

Terabyte, 13

Terminal state, 219–221

Testing status bits, 204

TEST instruction, 190,  
196–197

Text editor, 64, 71, 16.14

TEXTEQU directive,  
87–88

Text macro, 87, 429–430

32-bit integers, adding, 119

32-bit protected mode  
programs, 3Three integers, smallest of,  
204–205Time and data functions,  
14.16–14.20

Transfer control, 123

Translate buffer function, 568

Two-dimensional arrays  
base-index displacement  
operands, 371–372  
base-index operands,  
369–373  
ordering of rows and  
columns, 368–369Two integers  
exchanging, 320–321  
larger of, 204TYPEDEF operator,  
121–122, 314TYPE operator, 112, 115,  
120–121

---

**U**

---

Unconditional transfer, 123

Unicode standard, 19

Uninitialized data, declaring,  
83Unsigned integers, ranges of,  
13

.UNTIL condition, 225, 231

.UNTILCXZ condition, 225

Uppercase procedure,  
335–336USES operator, 152–153,  
317, 333–335

---

**V**

---

Variables, adding, 81–82

Video memory area, 14.3

Video RAM (VRAM),  
46, 646–647Virtual-8086 mode, 38, 40,  
42–43, 504

Virtual machine concept, 7–9

Virtual memory, 501–502

Visual C++ command-line  
options, 559Visual Studio Debugger  
arrays, displaying,  
125–126

CPU flags in, 104

Visual studio project  
properties, 578–579

---

**W**

---

WaitMsg procedure, 157,  
159, 168, 172

Wait states, 34

.WHILE condition, 225,  
231–232

WHILE directive, 433–434

WHILE loops, 214–216, 232

White box testing, 212–213

Win32 API Reference  
Information, 447Win32 console functions,  
450–452Win32 console programming,  
445–446background information,  
446–450

console input, 455–461

console output, 461–463

console window  
manipulation,  
473–476controlling cursor,  
476–477controlling text color,  
477–478displaying message box,  
452–455file I/O in Irvine32  
library, 468–470

- Win32 console programming (continued)
- reading and writing files, 463–468
  - testing file I/O procedures, 470–473
  - time and date functions, 479–482
  - Win32 console functions, 450–452
- Win32 date time functions, 479
- Win32 Platform SDK, 446
- Windows API functions
- character sets and, 447
  - 64-bit functions, 482–484
- Windows data types, 448
- WinMain procedure, 486–487
- WNDCLASS structure, 485–486, 506
- WORD data type, 58, 78
- Word (2 bytes), 13
- arrays of, 86, 103
- WriteBinB procedure, 157, 168
- WriteBin procedure, 157, 168, 172
- WriteChar procedure, 157, 169, 406–407
- WriteColors program, 478
- WriteConsole function, 452, 462
- WriteConsoleInput function, 452
- WriteConsoleOutputAttribute function, 452, 477
- WriteConsoleOutputCharacter function, 452, 461, 463
- WriteConsoleOutput function, 452
- WriteDec procedure, 157, 169
- WriteFile function, 467
- WriteFloat, 533–534
- WriteHex procedure, 157, 169, 172
- WriteHexB procedure, 157, 169, 179
- WriteHex64 procedure, 179, 336–337
- WriteInt procedure, 155, 157, 169, 172, 443
- WriteStackFrame procedure, 157, 322–323
- WriteString procedure, 154, 157, 169, 172–173, 461, 44.25
- WriteToFile procedure, 157, 169–170
- WriteWindowsMsg procedure, 157, 165–166, 170, 458, 494–495
- 
- X**
- 
- x86 computer, components
- of, 44
  - memory, 46
  - motherboard, 44–46
- x86 instruction coding
- instruction format, 540–541
  - memory-mode instructions, 544–547
  - move immediate to register, 541–542
  - processor operand-size prefix, 543–544
  - register-mode instructions, 542–543, 610
  - single-byte instructions, 541
- x86 instruction format, 540–541
- x86 memory management, 41–42, 446, 499–504
- linear addresses, 500–503
  - page transition (translation), 503–504
  - protected mode, 42
  - real-address mode, 42
- x86 processor, 1, 4, 16, 29, 62, 82, 96, 155, 243, 261, 346, 512, 17.5, 610
- x86 processor architecture, 32–50
- execution environment, 38–41, 43–44
  - floating-point unit, 41
  - modes of operation, 37–38
- XCHG instruction, 102
- XMM registers, 41, 43
- XOR instruction, 195–196, 206, 14.14
- 
- Y**
- 
- Yottabyte, 13
- 
- Z**
- 
- Zero flag, 40, 69, 107–108, 132, 162, 166, 191–194, 198, 200, 205, 209, 221, 223, 358, 386–387, 459, 531, 14.12, 608
- Zero/sign extension of integers, 99
- copying smaller values to larger ones, 99
  - MOVSX instruction, 100–101
  - MOVZX instruction, 99–100

## ONLINE ACCESS

Thank you for purchasing a new copy of *Assembly Language for x86 Processors, Seventh Edition*. Your textbook includes six months of prepaid access to the book's Companion Website. This prepaid subscription provides you with full access to the following student support areas:

- VideoNotes are step-by-step video tutorials specifically designed to enhance the programming concepts presented in this textbook
- Web Chapters
- Web Appendices

Use a coin to scratch off the coating and reveal your student access code.  
Do not use a knife or other sharp object as it may damage the code.

To access the *Assembly Language for x86 Processors, Seventh Edition*, Companion Website for the first time, you will need to register online using a computer with an Internet connection and a web browser. The process takes just a couple of minutes and only needs to be completed once.

1. Go to <http://www.pearsonhighered.com/irvine/>
2. Click on **Companion Website**.
3. Click on the **Register** button.
4. On the registration page, enter your student access code\* found beneath the scratch-off panel. Do not type the dashes. You can use lower- or uppercase.
5. Follow the on-screen instructions. If you need help at any time during the online registration process, simply click the **Need Help?** icon.
6. Once your personal Login Name and Password are confirmed, you can begin using the *Assembly Language for x86 Processors* Companion Website!

### To log in after you have registered:

You only need to register for this Companion Website once. After that, you can log in any time at <http://www.pearsonhighered.com/irvine/> by providing your Login Name and Password when prompted.

\*Important: The access code can only be used once. This subscription is valid for six months upon activation and is not transferable. If this access code has already been revealed, it may no longer be valid. If this is the case, you can purchase a subscription by going to <http://www.pearsonhighered.com/irvine/> and following the on-screen instructions.

| decimal | →            | 1    | 16 | 32    | 48 | 64 | 80 | 96 | 112 |
|---------|--------------|------|----|-------|----|----|----|----|-----|
| ↓       | hexa-decimal | 0    | 1  | 2     | 3  | 4  | 5  | 6  | 7   |
| 0       | 0            | null | ▶  | space | 0  | @  | P  | `  | p   |
| 1       | 1            | 😊    | ◀  | !     | 1  | A  | Q  | a  | q   |
| 2       | 2            | 😁    | ↕  | "     | 2  | B  | R  | b  | r   |
| 3       | 3            | ♥    | !! | #     | 3  | C  | S  | c  | s   |
| 4       | 4            | ♦    | Π  | \$    | 4  | D  | T  | d  | t   |
| 5       | 5            | ♣    | §  | %     | 5  | E  | U  | e  | u   |
| 6       | 6            | ♠    | ■  | &     | 6  | F  | V  | f  | v   |
| 7       | 7            | •    | ↕  | '     | 7  | G  | W  | g  | w   |
| 8       | 8            | ■●   | ^  | (     | 8  | H  | X  | h  | x   |
| 9       | 9            | ○    | ↓  | )     | 9  | I  | Y  | i  | y   |
| 10      | A            | ◼○   | →  | *     | :  | J  | Z  | j  | z   |
| 11      | B            | ♂    | ←  | +     | ;  | K  | [  | k  | {   |
| 12      | C            | ♀    | └  | ,     | <  | L  | \  | l  |     |
| 13      | D            | 🎵    | ↔  | -     | =  | M  | ]  | m  | }   |
| 14      | E            | 🎶    | ▲  | .     | >  | N  | ^  | n  | ~   |
| 15      | F            | ☀    | ▼  | /     | ?  | O  | _  | o  | Δ   |



| decimal | ⇒            | 128 | 144      | 160 | 176 | 192 | 208 | 224 | 240      |
|---------|--------------|-----|----------|-----|-----|-----|-----|-----|----------|
|         | hexa-decimal | 8   | 9        | A   | B   | C   | D   | E   | F        |
| 0       | 0            | Ç   | É        | á   | ⋮   | ⊥   | ⊥   | α   | ≡        |
| 1       | 1            | ü   | æ        | í   | ⊗   | ⊥   | ⊥   | β   | ±        |
| 2       | 2            | é   | Æ        | ó   | ⋮   | ⊥   | ⊥   | Γ   | ≥        |
| 3       | 3            | â   | ô        | ú   |     | ⊥   | ⊥   | π   | ≤        |
| 4       | 4            | ä   | ö        | ñ   | ⊥   | —   | ⊥   | Σ   | <i>f</i> |
| 5       | 5            | à   | ò        | Ñ   | ⊥   | ⊥   | ⊥   | σ   | <i>f</i> |
| 6       | 6            | å   | û        | ǣ   | ⊥   | ⊥   | ⊥   | μ   | ÷        |
| 7       | 7            | ç   | ù        | ⊙   | ⊥   | ⊥   | ⊥   | τ   | ≈        |
| 8       | 8            | ê   | ÿ        | ç   | ⊥   | ⊥   | ⊥   | Φ   | ○        |
| 9       | 9            | ë   | Ö        | Γ   | ⊥   | ⊥   | ⊥   | θ   | •        |
| 10      | A            | è   | Ü        | ⊥   |     | ⊥   | ⊥   | Ω   | •        |
| 11      | B            | ï   | ç        | ½   | ⊥   | ⊥   | ■   | δ   | √        |
| 12      | C            | î   | £        | ¼   | ⊥   | ⊥   | ■   | ∞   | n        |
| 13      | D            | ì   | ¥        | i   | ⊥   | =   | ■   | φ   | 2        |
| 14      | E            | Ä   | Pt       | «   | ⊥   | ⊥   | ■   | ε   | ■        |
| 15      | F            | Å   | <i>f</i> | »   | ⊥   | ⊥   | ■   | ∩   | blank    |